LSU BOARD OF SUPERVISORS MEETING
*Board Room, University Administration Building
3810 West Lakeshore Drive, Baton Rouge, LA 70808
October 28-29, 2021*

Thursday, October 28, 2021 2:00 p.m. CT

- I. Call to Order and Roll Call
- II. Invocation and Pledge of Allegiance
- III. Public Comment
- IV. Committee Meetings
 - A. Research & Agricultural Extension Committee
 1. Presentation from Pennington Biomedical Research Center
 - B. Title IX & Access Committee
 1. Report by Office of Title IX and Civil Rights
 - C. Academic Committee
 1. Request from LSU Alexandria to Establish the Bachelor of Applied Arts & Sciences
 2. Consent Agenda
 - a. Request from LSU A&M to Change the Degree Designation of the Master of Digital Media Arts & Engineering to the Master of Science in Digital Media Arts & Engineering
 - b. Request from LSU Eunice to Establish the Acadian Medical Center Pink Ladies Endowed Two-Year Student Workforce Scholarship
 - c. Request from LSU Eunice to Establish the Charles Richard “Dickey” Bier Memorial Endowed Two-Year Student Workforce Scholarship
 - d. Request from LSU Eunice to Establish the Fritz Lang #2 Endowed Two-Year Student Workforce Scholarship
 - e. Request from LSU Ag Center to Establish the Rice Research Board Chair of Rice Variety Development
 - f. Request from LSU A&M to Award a Posthumous Degree to Mr. Rishi Reddy Banda
 - D. Finance Committee
 - a. Recommendation to Approve the Fiscal Year 2022-2023 Operating Budget Request
 - b. Request to Authorize the University to Enter Into a Contract for the Implementation of a Student Information System
 - c. Request from LSU A&M for Bond Refinancing
 - d. Update on Supplier Diversity Program

The Board or its Committees may enter into Executive Session in accordance with the provisions of LA R.S. 42:17

- E. Property & Facilities Committee
 - 1. Request from LSU Health Sciences Center - New Orleans to Approve the Execution of an Amendment to the Master Hospital Lease to Remove the Orange and Brown Parking Areas from the Master Hospital Lease
 - 2. Request to Authorize a Cooperative Endeavor Agreement and Lease for the Utilities Modernization Initiative
 - 3. Request from LSU A&M to Amend the FY 2022-2023 Five-Year Capital Outlay Budget Request and First Year Prioritized List for Louisiana State University
- F. Athletics Committee
 - 1. Request from LSU A&M to Approve Contract Amendments for the Head Track & Field Coach
 - 2. Request from LSU A&M to Approve Contract for the Head Football Coach
 - 3. Request from LSU A&M to Approve Termination Agreement for the Head Football Coach

Friday, October 29, 2021 8:00 a.m.

- G. Risk Management Committee (*Room 104A University Administration Building*)
 - 1. FY2022 1st Quarter Audit Summary
The Board or its Committees may enter into Executive Session in accordance with the provisions of LA R.S. 42:17

Friday, October 29, 2021 9:00 a.m.

- V. Reconvene Board Meeting
- VI. Title IX Presentation and Training
- VII. Approval of Minutes from the September 10, 2021 Board Meeting
- VIII. Personnel Actions Requiring Board Approval
- IX. Reports to the Board
 - A. Fall 2021 14th Day Enrollment & Trend Report
 - B. Facility Summary Reports
 - C. Quarterly Report on Pharmacy Benefit Manager
- X. Reports from Faculty Advisors and Staff Advisors
- XI. President's Report
- XII. Approval of Committee Recommendations
- XIII. Chair's Report
- XIV. Adjournment

In the event Committees scheduled for Thursday are unable to complete their work on that day, they will convene on Friday at 9:00 a.m.

The Board or its Committees may enter into Executive Session in accordance with the provisions of LA R.S. 42:17



Board of Supervisors

TITLE IX & ACCESS COMMITTEE

BOARD OF SUPERVISORS MEETING | OCTOBER 28-29, 2021



Board of Supervisors

ACADEMIC COMMITTEE

BOARD OF SUPERVISORS MEETING | OCTOBER 28-29, 2021



Board of Supervisors

Request from LSU Alexandria to Establish a Bachelor of Applied Arts & Sciences

Date: October 28-29, 2021

1. Bylaw Citation

Pursuant to Article VII, Section 1, Paragraph B of the Bylaws of the Louisiana State University Board of Supervisors, this matter is a significant board matter.

B. Any new academic degree program

2. Summary of Matter

The Board of Regents approved LSU Alexandria's Letter of Intent request for a Bachelor of Applied Arts & Sciences at their August 25, 2021 meeting.

Associate of Applied Arts (AAA) and Associate of Applied Science (AAS) degrees are designed to prepare students for direct entry into the workforce with a heavy focus on professional courses. These programs often require only 15 hours of general education while the more academically focused Associate of Arts (AA) and Associate of Science (AS) degrees require a minimum of 27. As graduates of applied associate degrees gain work experience, they often seek to further their education and consequently their earning power by completing a four-year baccalaureate program. These students often have difficulty transferring all previous coursework and must frequently complete far more than the typical 120 hours required for a bachelor's degree increasing time and expense until degree completion. The proposed onsite and online BAAS will be a completer degree allowing students who have earned an AAA or AAS at an accredited community college to transfer the 60 hours of lower-level credit required by the associate degree to the proposed baccalaureate program. Dr. René Cintrón, Chief Education and Training Officer for the Louisiana Community and Technical College System, has written a letter expressing his interest in and support for the proposed program. LSU Alexandria has also talked with LSU Online leadership about offering a pathway from the proposed Bachelor of Applied Arts and Science to appropriate graduate-level programs offered by LSU.

The flexibility of the degree will allow some students, particularly those who have transcripts from several institutions, to transfer up to 84 hours of earned credit to the program. This flexibility will be particularly useful for veterans and active-duty military who, because of the nature of military service, tend to earn credit from a variety of institutions and can be awarded credit based on the assessment of training received from military programs. The degree also provides flexibility for students who have completed applied arts or applied science courses, such as those in culinary arts, that may not be accepted for degree credit in most traditional baccalaureate programs. While common in some other states, this program would be the first of its kind in Louisiana.

The major will complement the practical knowledge and skills that students acquire in an applied art or applied science program with more conceptual and theory-based courses, including courses in communication, management, and leadership. The major will also provide

¹<http://www.aamc.org/media/45976/download>

students with the opportunity to develop a personal career strategy and to create a portfolio of work that will demonstrate their educational achievements to prospective employers.

In 2019, 10,818 associate degrees were awarded in Louisiana. This indicates there is a very substantial population of students who might be interested in pursuing a baccalaureate-level credential. Furthermore, only nine percent of individuals between the ages of 25-64 who reside in the Region 6 Labor Market, the region served by LSU Alexandria, hold bachelor's degrees. This average compares very unfavorably to the averages of all eight Louisiana labor markets, markets in which 12.8 percent of the over-25 population hold bachelor degrees. Projected enrollment starts at 55 students, increasing to 100 students by Year 5.

3. Review of Business Plan

The Bachelor of Applied Arts & Sciences will be housed in the Department of Marketing and Management, an administrative unit within LSU Alexandria's College of Business.

LSU Alexandria will be able to offer the Bachelor of Applied Arts and Sciences at minimal additional cost as it will not have to hire additional full-time faculty during the first three years of the program's life; courses in the major will be taught by existing full-time and part-time faculty. It is anticipated that as the program develops and its enrollment increases, the university will hire an instructor to teach two Applied Arts and Sciences courses. This hire would likely take place in Year Four of the program. The program will have six full-time faculty members involved. The proposed program will also not require any additional space, remodeling of existing space, or new equipment.

4. Fiscal Impact

The main additional cost required by the proposed program will be the hiring of a new full-time faculty member for Year Four of the program's existence. The estimated cost, including benefits, of the faculty addition for a single academic year is \$100,000. Tuition and fees from projected enrollments will more than cover the necessary costs associated with the program. As program enrollment grows, additional faculty members will be added to meet staffing requirements. It is not anticipated that the proposed program will result in any significant reallocation of departmental funds.

5. Description of Competitive Process

Not Applicable

6. Review of Legal Documents

Not Applicable

7. Parties of Interest

Not Applicable

8. Related Transactions

Not Applicable

9. Conflicts of Interest

Not Applicable

10. Attachments

Not Applicable

RESOLUTION

NOW, THEREFORE, BE IT RESOLVED that the Board of Supervisors of Louisiana State University and Agricultural & Mechanical College does hereby approve the request from LSU Alexandria to establish the Bachelor of Applied Arts & Sciences.



Board of Supervisors

Request from LSU A&M to Change the Degree Designation of the Master of Digital Media Arts & Engineering to the Master of Science in Digital Media Arts & Engineering

Date: October 29, 2021

1. Bylaw Citation

Pursuant to Article VII, Section 1, Paragraph B of the Bylaws of the Louisiana State University Board of Supervisors, this matter is a significant board matter.

- B. Any matter having a significant or long-term impact, directly or indirectly, on the finances or the academic, educational, research, and service missions of the University or any of its campuses.

2. Summary of Matter

The Master of Digital Media Arts and Engineering (MDMAE) is a collaborative interdisciplinary degree, which was approved in 2016 and is a joint effort between the College of Engineering and the School of Art in the College of Art & Design.

Because the percentage of arts content, specifically digital art, is above the threshold percentage, it became apparent after the degree was created that it fell under the purview of the arts accreditation body, the National Association of Schools of Art & Design (NASAD). The degree was submitted to NASAD for Approval for Listing as part of LSU's overall accreditation process. This led to a two-year dialog with the NASAD Commission on Accreditation over NASAD's concerns about the degree title, not the degree content.

The Commission has the view that the "Master of" title within the arts arena is reserved for terminal degrees such as the Master of Fine Arts and that the MDMAE designation introduces confusion of terminology to a degree in this arena as it is not a terminal degree. The discussion between the LSU A&M campus, the Louisiana Board of Regents, and the Commission on Accreditation has led to a proposed resolution of retitling the degree to bring it into line with terminology in the field.

The deans of the College of Engineering and the College of Art & Design both request approval to rename the degree designation from "Master of Digital Media Arts & Engineering" to "Master of Science in Digital Media Arts & Engineering".

3. Review of Business Plan

Not applicable

4. Fiscal Impact

Not applicable

5. Description of Competitive Process

Not Applicable

6. Review of Legal Documents

Not Applicable

7. Parties of Interest

Not Applicable

8. Related Transactions

Not Applicable

9. Conflicts of Interest

Not Applicable

10. Attachments

None

RESOLUTION

NOW, THEREFORE, BE IT RESOLVED that the Board of Supervisors of Louisiana State University and Agricultural & Mechanical College does hereby approve the request to change the degree designation of the Master of Digital Media Arts & Engineering to the Master of Science in Digital Media Arts & Engineering.



Board of Supervisors

Request from LSU Eunice to Establish the Acadian Medical Center Pink Ladies Endowed Two-Year Student Workforce Scholarship

Date: October 28-29, 2021

1. Bylaw Citation

Pursuant to Article VII, Section 1, Paragraph A of the Bylaws of the Louisiana State University Board of Supervisors, this matter is a significant board matter.

- A. Any matter having a significant or long-term impact, directly or indirectly, on the finances or the academic, educational, research, and service missions of the University or any of its campuses

2. Summary of Matter

The competitive Endowed Two-Year Student Workforce Scholarships subprogram provides scholarship opportunities for students on two-year campuses to enter the Louisiana workforce in the following ways: (a) train students for immediate entrance into selected, high-demand, four- and five-star jobs, including positions in nursing and allied health (see Section V); and/or (b) prepare students to become job-ready in STEM fields after completing degrees on four-year campuses. Non-State contributions combined with a BoRSF match will produce permanent endowments. This subprogram replaces the Enhancement Subprogram for Two-Year Institutions.

The Acadian Medical Center Pink Ladies are endowing \$20,000 with the LSUE Foundation for the benefit of the institution, subject to available matching funds from the Board of Regents. The scholarship will be awarded to a non-traditional student enrolled in Respiratory Care or Radiologic Technology programs.

Since LSU Eunice is requesting an additional Board of Regents match, a second Fritz Lang scholarship must be established.

- **Acadian Medical Center Pink Ladies Scholarship - \$20,000**

3. Review of Business Plan

Not applicable

4. Fiscal Impact

Not applicable

5. Description of Competitive Process

Not applicable

6. Review of Legal Documents

Not applicable

7. Parties of Interest

LSU Eunice Foundation

8. Related Transactions

Not applicable

9. Conflicts of Interest

Not applicable

10. Attachments

None

RESOLUTION

NOW, THEREFORE, BE IT RESOLVED that the Board of Supervisors of Louisiana State University and Agricultural & Mechanical College does hereby approve the request from LSU Eunice to establish the Acadian Medical Center Pink Ladies Endowed Two-Year Student Workforce Scholarship; and,

BE IT FURTHER RESOLVED that the Chairman of the Board of Supervisors and/or the President, as may be appropriate, are hereby authorized to execute any documents required to obtain the matching gift and otherwise complete the establishment of the Acadian Medical Center Pink Ladies Endowed Two-Year Student Workforce Scholarship.



Board of Supervisors

Request from LSU Eunice to Establish the Charles Richard “Dickey” Bier Memorial Endowed Two-Year Student Workforce Scholarship

Date: October 28-29, 2021

1. Bylaw Citation

Pursuant to Article VII, Section 1, Paragraph A of the Bylaws of the Louisiana State University Board of Supervisors, this matter is a significant board matter.

- A. Any matter having a significant or long-term impact, directly or indirectly, on the finances or the academic, educational, research, and service missions of the University or any of its campuses

2. Summary of Matter

The competitive Endowed Two-Year Student Workforce Scholarships subprogram provides scholarship opportunities for students on two-year campuses to enter the Louisiana workforce in the following ways: (a) train students for immediate entrance into selected, high-demand, four- and five-star jobs, including positions in nursing and allied health (see Section V); and/or (b) prepare students to become job-ready in STEM fields after completing degrees on four-year campuses. Non-State contributions combined with a BoRSF match will produce permanent endowments. This subprogram replaces the Enhancement Subprogram for Two-Year Institutions.

The Florence Mauboules Trust endowed \$20,000 with the LSUE Foundation for the benefit of the institution. The Endowment is established to support an endowed scholarship known as the Charles Richard “Dickey” Bier Memorial Scholarship, subject to available matching funds from the Board of Regents. The scholarship will be awarded to a full-time student attending LSU Eunice, enrolled in pre-education with plans to transfer to a four-year college.

- **Charles Richard “Dickey” Bier Memorial Scholarship - \$20,000**

3. Review of Business Plan

Not applicable

4. Fiscal Impact

Not applicable

5. Description of Competitive Process

Not applicable

6. Review of Legal Documents

Not applicable

7. Parties of Interest

LSU Eunice Foundation

8. Related Transactions

Not applicable

9. Conflicts of Interest

Not applicable

10. Attachments

None

RESOLUTION

NOW, THEREFORE, BE IT RESOLVED that the Board of Supervisors of Louisiana State University and Agricultural & Mechanical College does hereby approve the request from LSU Eunice to establish the Charles Richard “Dickey” Bier Memorial Endowed Two-Year Student Workforce Scholarship; and,

BE IT FURTHER RESOLVED that the Chairman of the Board of Supervisors and/or the President, as may be appropriate, are hereby authorized to execute any documents required to obtain the matching gift and otherwise complete the establishment of the Charles Richard “Dickey” Bier Memorial Endowed Two-Year Student Workforce Scholarship.



Board of Supervisors

Request from LSU Eunice to Establish the Fritz Lang #2 Endowed Two-Year Student Workforce Scholarship

Date: October 28-29, 2021

1. Bylaw Citation

Pursuant to Article VII, Section 1, Paragraph A of the Bylaws of the Louisiana State University Board of Supervisors, this matter is a significant board matter.

- A. Any matter having a significant or long-term impact, directly or indirectly, on the finances or the academic, educational, research, and service missions of the University or any of its campuses

2. Summary of Matter

The competitive Endowed Two-Year Student Workforce Scholarships subprogram provides scholarship opportunities for students on two-year campuses to enter the Louisiana workforce in the following ways: (a) train students for immediate entrance into selected, high-demand, four- and five-star jobs, including positions in nursing and allied health (see Section V); and/or (b) prepare students to become job-ready in STEM fields after completing degrees on four-year campuses. Non-State contributions combined with a BoRSF match will produce permanent endowments. This subprogram replaces the Enhancement Subprogram for Two-Year Institutions.

An additional \$50,000 in contributions have been secured for the Fritz Lang Endowed Scholarship, subject to available matching funds from the Board of Regents. The scholarship will be awarded to a full-time student attending LSU Eunice, enrolled in a STEM program in an agricultural-specific discipline with plans to transfer to a four-year college.

Since LSU Eunice is requesting an additional Board of Regents match, a second Fritz Lang scholarship must be established.

- **Fritz Lang #2 Scholarship - \$50,000**

3. Review of Business Plan

Not applicable

4. Fiscal Impact

Not applicable

5. Description of Competitive Process

Not applicable

6. Review of Legal Documents

Not applicable

7. Parties of Interest

LSU Eunice Foundation

8. Related Transactions

Not applicable

9. Conflicts of Interest

Not applicable

10. Attachments

Memo from the LSU Eunice Chancellor

RESOLUTION

NOW, THEREFORE, BE IT RESOLVED that the Board of Supervisors of Louisiana State University and Agricultural & Mechanical College does hereby approve the request from LSU Eunice to establish the Fritz Lang #2 Endowed Two-Year Student Workforce Scholarship; and,

BE IT FURTHER RESOLVED that the Chairman of the Board of Supervisors and/or the President, as may be appropriate, are hereby authorized to execute any documents required to obtain the matching gift and otherwise complete the establishment of the Fritz Lang #2 Endowed Two-Year Student Workforce Scholarship.



Board of Supervisors

Request from the LSU Agricultural Center to Establish the Rice Research Board Chair for Rice Variety Development

Date: October 28-29, 2021

1. Bylaw Citation

Pursuant to Article VII, Section 1, Paragraph A of the Bylaws of the Louisiana State University Board of Supervisors, this matter is a significant board matter.

- A. Any matter having a significant or long-term impact, directly or indirectly, on the finances or the academic, educational, research, and service missions of the University or any of its campuses.

2. Summary of Matter

Due to outstanding investment performance and the Louisiana Rice Research Board's ability to augment the existing Chair for Excellence in Rice Research (Excellence Chair) with additional contributions over the last few years, the Louisiana Rice Research Board voted to create a second chair (Variety Development Chair) by splitting off one-third of the existing Excellence Chair.

In November 2018, the Louisiana Rice Research Board, a political subdivision of the State of Louisiana, and the LSU Foundation entered into an agreement establishing an endowment supporting the Louisiana Rice Research Board Chair for Excellence in Rice Research. In July 2021, the Endowment Agreement was amended to transfer a portion of the principal to a second endowment supporting the Louisiana Rice Research Board Chair for Rice Variety Development.

This position shall be held by an LSU Ag Center faculty member working in rice variety development.

No matching funds from the Board of Regents are sought for the Excellence Chair, and no matching funds will be pursued for the Variety Development Chair. At this time, the LSU Agricultural Center is seeking approval from the Board of Supervisors to create and award the Variety Development Chair.

3. Business Plan

Not applicable

4. Fiscal Impact

Not applicable

5. Description of Competitive Process

Not applicable

6. Review of Legal Documents

Not applicable

7. Parties of Interest

Not applicable

8. Related Transactions

Not applicable

9. Conflicts of Interest

Not applicable

10. Attachments

None

RESOLUTION

NOW, THEREFORE, BE IT RESOLVED that the Board of Supervisors of Louisiana State University and Agricultural & Mechanical College does hereby approve the request from the LSU Agricultural Center to establish the Rice Research Board Chair for Rice Variety Development



Board of Supervisors

Request from LSU A&M to Award a Posthumous Degree to Mr. Rishi Reddy Banda

Date: October 28-29, 2021

1. Bylaw Citation

Pursuant to Article VII, Section 1, Paragraph C of the Bylaws of the Louisiana State University Board of Supervisors, this matter is a significant board matter.

- C. Any matter having a significant or long-term impact, directly or indirectly, on the finances or the academic, educational, research, and service missions of the University or any of its campuses

2. Summary of Matter

Mr. Rishi Reddy Banda received his BA in Economics from LSU A&M in the fall of 2017. He then began his graduate studies in the Online Flores MBA Program in October 2020. During his final summer term in the program, Mr. Banda was enrolled in required coursework. He was on track to complete his degree during the summer 2021 semester.

During his academic career, Mr. Banda was a hardworking professional. He consistently ranked among some of the highest academically achieving students in the program. He had a 3.9 LSU and overall grade point average. Faculty and other affiliated professionals in the program stated that Mr. Banda was a dedicated student, a wonderful and collaborative classmate, and an active participant in the program's activities.

Mr. Banda's life ended in July of 2021. The E.J. Ourso College of Business at LSU considered Mr. Banda to be one of the College's most promising students and was on track to become an outstanding business professional.

The faculty and Director of the online Flores MBA program, the Dean of the E.J. Ourso College of Business, the Dean of the Graduate School, and the administration of Louisiana State University request that Mr. Rishi Reddy Banda be awarded the Master of Business Administration (MBA) posthumously, having no doubt that he would have completed all program requirements in good standing. By awarding this degree, the University acknowledges Mr. Banda's academic achievements and provides his family with a symbol of appreciation of his talents and the life he shared with us.

3. Review of Business Plan

Not Applicable

4. Fiscal Impact

Not Applicable

5. Description of Competitive Process

Not Applicable

6. Review of Legal Documents

Not Applicable

7. Parties of Interest

LSU Eunice Foundation

8. Related Transactions

Not Applicable

9. Conflicts of Interest

Not Applicable

10. Attachments

None

RESOLUTION

NOW, THEREFORE, BE IT RESOLVED that the Board of Supervisors of Louisiana State University and Agricultural & Mechanical College does hereby authorize the awarding of the Master of Business Administration degree to Mr. Rishi Reddy Banda, posthumously.



Board of Supervisors

FINANCE COMMITTEE

BOARD OF SUPERVISORS MEETING | OCTOBER 28-29, 2021



Board of Supervisors

Recommendation to Approve the Fiscal Year 2022-23 Operating Budget Request

Date: October 28, 2021

1. Bylaw Citation

Pursuant to Article VII, Section 1:

- A. Any matter having a significant or long-term impact, directly or indirectly, on the finances or the academic, educational, research, and service missions of the University or any of its campuses.

2. Summary of Matter

Each year a budget request that details the needs of all LSU campuses and entities for the upcoming fiscal year is completed. The budget request for formula campuses is prepared under instructions issued by the State in which modifications are made to existing operating budget forms. Officially, the total budget request for state funds for formula campuses is submitted by the Board of Regents to the Division of Administration and Legislature with a request for funding of the formula for higher education as calculated that year. On Wednesday, October 20, 2021, the Board of Regents will consider and approve a budget request for postsecondary education based on a preliminary formula calculation for the formula institutions and other identified budget needs for higher education systems, boards, and agencies. The formula will then be updated in the spring as additional information becomes available and presented as the final request to the Legislature at the end of March.

Traditionally, the Division of Administration's higher education budget manager requests that campuses submit information on operational or expanded need activities (see **Attachment I**) that the campuses identify as priorities for funding. The submission of these operational or expanded need items is **not** part of the "official" budget request, and is only submitted at the request of the Division of Administration higher education budget manager for informational purposes.

The preliminary total unrestricted budget request for all entities under the supervision of the Board for FY 2022-23 will not be known until the Louisiana Board of Regents releases the preliminary formula for the formula campuses along with other identified budget needs for higher education systems, boards, and agencies. Additional information on the Regents' FY 2022-23 budget request will be sent to the Board under separate cover at that time.

LSU campuses and entities have submitted their budget forms in the format required by the Division of Administration and the Board of Regents. These forms use the FY 2021-22 budget as the starting point for the FY 2022-23 budget request and are available on the website. The Operational or Expanded Need Requests (**Attachment I**) represent the campuses' priorities for additional resources in FY 2022-23.

3. Review of Business Plan

N/A

4. Fiscal Impact

There is no immediate impact of this budget request as it represents the first step in the FY 2022-23 budget process.

5. Description of Competitive Process

N/A

6. Review of Legal Documents

N/A

7. Parties of Interest

N/A

8. Related Transactions

N/A

9. Conflicts of Interest

N/A

10. Attachment

- I. Summary of FY 2022-23 Operational or Expanded Need Requests

RESOLUTION

NOW, THEREFORE, BE IT RESOLVED that the Board of Supervisors does hereby authorize the President of Louisiana State University, or their designee, to approve the preliminary budget request for the fiscal year ending June 30, 2023. The budget request consists of state appropriations and other operating budget funds for the LSU campuses and entities based on the requests of the respective campuses and entities and the preliminary Board of Regents funding formula.

BE IT FURTHER RESOLVED that the Board does hereby authorize the President to continue to work with the Board of Regents on the appropriate formula methodology and budget request for the LSU units to be used for the FY 2022-23 budget request and, with notice to the Board, to act on behalf of the Board in approving the final FY 2022-23 budget request for all LSU campuses and entities. The Board hereby delegates all such authority necessary to accomplish such purposes to the President, or their designee.

BE IT FURTHER RESOLVED that the Board does hereby approve the proposed requests for operational or expanded need activities, based on the information provided by the respective

LSU campuses and entities, which will be provided upon request to the higher education budget manager of the state Division of Administration.

BE IT FURTHER RESOLVED that transactions included or referred to in the proposed operating budget that otherwise require Board approval are not approved by mere inclusion in the proposed operating budget.

**OPERATIONAL OR EXPANDED NEED
PRIORITY LIST**

School: **LSU System and A&M College**

State General Fund (Direct)

PRIORITY	PROJECT/SERVICE	BRIEF DESCRIPTION	AMOUNT
1	Faculty and Staff Merit		\$12,384,000
2	Civil Rights & Title IX Expansion		\$2,500,000
3	STEM Initiative		\$5,000,000
4	Deferred Maintenance		\$10,000,000
5	Increase Salary/Wages to \$15/hour		\$2,375,000
		Total	\$32,259,000

School: **LSU Agricultural Center**

PRIORITY	PROJECT/SERVICE	BRIEF DESCRIPTION	AMOUNT
1	Operational Expense Increases	Faculty/Salary increases and increases to maintain current level of support and operations	\$4,000,000
2	Plant Biotechnology/Crop Development	Support for research under the Center of Research Excellence in Plant Biotechnology and Crop Development	\$1,500,000
3	Digital Agriculture	Funding in support of a core team of faculty to collect research, teach and train stakeholders in the collection and use of digital technology in agriculture	\$1,500,000
4	Food Safety	Improve the health of consumers by focusing on current and emerging issues pertaining to the Food Safety Modernization Act	\$2,000,000
5	Childhood Obesity - Healthy Lifestyles	Additional exhibits, supplies and salaries in support of reducing the prevalence of childhood obesity in Louisiana	\$600,000
6	4-H Youth Character/Workforce Development	Support to implement the State Schools of Character Awards	\$350,000
7	Healthy Communities	Improve the health of citizens by developing locally supported coalitions that promote healthful eating and physically active lifestyles.	\$2,500,000
8	Water Resources	Identify fresh water resource (quantity and quality) issues, develop research plans to address long-term	\$1,400,000
		Total	\$13,850,000

**OPERATIONAL OR EXPANDED NEED
PRIORITY LIST**

School: LSU Pennington Biomedical Research Center

PRIORITY	PROJECT/SERVICE	BRIEF DESCRIPTION	AMOUNT
1	Recruitment of Faculty	Pennington Biomedical needs mid- to senior-level faculty who will direct independent research programs in areas of basic, clinical and population/public health research.	\$4,368,000
2	Bioinformatics/big data program development	Pennington Biomedical needs mid- to senior-level faculty who will work with our existing faculty, and will expand the capabilities of biological research data analysis using bioinformatics.	\$1,010,000
3	Wellness/clinical care program development	Pennington needs to expand its core of Clinical Research doctors/researchers to develop wellness and clinical care programs.	\$1,456,000
4	Faculty and staff merits	Pennington Biomedical faculty/staff pay increase of 3%	\$1,123,006
5	Getting Civil Service entry salaries to \$15 per hour	Getting Civil Service entry salaries to \$15 per hour	\$114,872
6	Metabolomics program development	Pennington Biomedical needs mid- to senior-level faculty who will direct independent research programs in areas of metabolomic research.	\$974,000
7	Deferred Maintenance		\$9,800,000
			Total
			\$18,845,878

School: LSU - Alexandria

PRIORITY	PROJECT/SERVICE	BRIEF DESCRIPTION	AMOUNT
1	Faculty/Staff Salary Merits	Offer competitive salary to maintain quality faculty and staff	\$595,211
2	STEM initiative	Increase offerings in STEM fields to meet local workforce needs	\$357,000
3	Title IX funding	Create and maintain a community of respect	\$140,000
4	Deferred Maintenance	Address the growing list of Deferred Maintenance issues on campus	\$578,000
5	Getting Civil Service entry salaries to \$15 per hour	Offer competitive pay to maintain quality classified employees	\$236,000
			Total
			\$1,906,211

**OPERATIONAL OR EXPANDED NEED
PRIORITY LIST**

School: LSU - Eunice

PRIORITY	PROJECT/SERVICE	BRIEF DESCRIPTION	AMOUNT
1	Faculty & Staff Increases	Faculty & Staff Merit	\$475,000
2	Civil Service entry salaries	Civil Service entry salaries are extremely low and we would like to see the entry salaries increased to at least \$12-15 per hour	\$265,000
3	Steam Innovation Center initiative	Cost of equipment, technology and faculty needed to support our STEAM Innovation Center initiative	\$5,350,000
4	Emergency Preparedness	Upgrade emergency preparedness and safety enhancements for campus by providing additional staffing, cameras and equipment to support campus needs	\$336,500
5	Deferred Maintenance	Campus deferred maintenance	\$12,099,000
Total			\$18,525,500

**OPERATIONAL OR EXPANDED NEED
PRIORITY LIST**

School: **LSU - Shreveport**

PRIORITY	PROJECT/SERVICE	BRIEF DESCRIPTION	AMOUNT
1	Faculty & Staff Merit Wage Increase	Address Salary Compaction to maintain quality faculty & staff	\$800,000
2	Quality STEM & Health Care Initiatives Including stellar K-12 Stem Programs	As part of the strategic plan related to health and healthy communities, LSUS has begun looking at various ways to partner within the community and develop various academic programs, certifications and licensures to achieve goals within the strategic plan. With our new state of the art Cybercollaboratory & Exercise Science Lab with the one of a kind atmospheric chamber, LSUS is poised to collaborate in teaching, research and community collaboration	\$550,000
3	Deferred Maintenance	Due to the aging equipment, lack of controls, and finally, the inability to recruit and train Facility Plant Operators that can operate and maintain high pressure boilers for heating our campus, LSUS needs to decentralize the boiler system on campus so that each building has the ability to be heated with its own boilers. Further the High Voltage Electrical Switch Gear and the related infrastructure on campus is at end of life. If we were to have a power outage causing the switch gear to go down, we would be unable to power the entire campus. These two projects are the top two priority on our deferred maintenance list.	\$1,550,000
4	Health & Physical Education Building - Physical Recreation Area	Because of the age, design and failures of the swimming pool located in the Health & Physical Education Building, LSUS has decided it must be closed. While it will be missed, it gives us the opportunity to create a new recreation area within the space to be utilized by students, especially those students that live in the newly renovated Pilots Pointe Apartments.	\$850,000
Total			\$3,750,000

**OPERATIONAL OR EXPANDED NEED
PRIORITY LIST**

School: LSU - Health Sciences Center - New Orleans

PRIORITY	PROJECT/SERVICE	BRIEF DESCRIPTION	AMOUNT
1	Civil Service Classified Market Adjustment	Civil Service Classified Increases	\$434,752
2	Faculty Promotion in Rank	Increases for Faculty Promotion	\$240,734
3	Faculty and Staff Salary Increases	Funding for Faculty and Staff Salary Increases	\$1,494,894
4	Operating Costs for New Building - Center for Advanced Learning and Simulation	Operating Costs for Bldg. per sq. foot	\$6,000,000
5	Group Benefits and Retirement Increases	Increases in Mandated Costs	*
6	Library Inflation	Inflation for Library Items	\$745,708
7	Inflation	Inflation for General Items	\$579,536
8	Dentistry Rural Scholar Track	Funding for Rural Scholars Program	\$56,836
Total			\$9,552,460

*Annual increases in group insurance and retirement are also requested to be funded.

School: LSU - Health Sciences Center - Shreveport

PRIORITY	PROJECT/SERVICE	BRIEF DESCRIPTION	AMOUNT
1	Legacy Costs	Hospital Transitions to Public Private Partnerships	\$14,510,494
2	Center for Medical Education and Wellness Building	Furniture, Fixtures, and Equipment	\$7,200,000
3	Faculty, Unclassified, and Classified Base Salary Equity Adjustments	Equity Adjustments	\$850,000
4	Faculty and Unclassified Base Salary Increases	2% Base Salary Increases	\$2,755,942
Total			\$25,316,436



Board of Supervisors

Request to Authorize the University to Enter Into a Contract for a Student Information System

Date: October 28-29, 2021

1. Bylaw Citation

Pursuant to Article VII, Section 1

A. Any matter having a significant or long-term impact, directly or indirectly, on the finances or the academic, educational, research, and service missions of the University or any of its campuses.

2. Summary of Matter

The university is seeking to upgrade its student information system (SIS) from the mainframe-based COBOL technology that it currently utilizes. After a nearly 40-year life span, the sustainability, agility, and effectiveness of this mainframe-based system has diminished significantly, and the university needs to move to a technology and system that can better support its changing mission and strategic goals. A new SIS will provide a variety of advantages in both systems stability, capabilities to the user while yielding more financial predictability by being more sustainable. The SIS will provide enhanced business intelligence and analytical capabilities.

The primary benefits to the SIS upgrade include:

- Moving to a modern predictable subscription-based Software-as-a-Service (SaaS) model that promises better business continuity outcomes;
- Configurable system functionality taking the place of customized code that is difficult to maintain;
- Greater and more efficient access to useable student data, including distributed access where appropriate;
- Simplified integration methodology with other industry software and services; and
- Simplified workflow and processes for students, faculty, and staff.

To maximize these benefits across LSU and to take advantage of economies of scale, the SIS implementation will include LSU A&M, LSUA, LSUE, and LSUS.

3. Review of Business Plan

Not Applicable

4. Fiscal Impact

There are two components to the cost of the SIS upgrade. The first is the SaaS subscription cost. This will be based on the number of full-time equivalent (FTE) students at each campus. Workday, Inc.'s proposal quoted the subscription cost at \$52.52 per student. At current enrollment levels, the total subscription cost is estimated at \$1.9 million annually. As outlined in the proposal, this subscription cost will not start until Year 4 of the contract.

There will also be significant, one-time implementation costs for the new SIS. Workday, Inc. has identified Deloitte LLP as its implementation partner for this project. Implementation costs will be dependent on the number and complexity of configurations, integrations, and change management services. These details are currently being worked through with the chosen solution. The estimated amount for implementation at the LSU A&M campus from the proposal is \$35 million, inclusive of travel costs.

5. Description of Competitive Process

LSU Academic Affairs and Information Technology Services (ITS) began collaborating with the Office of Procurement Services on the specifications for the solicitation in February 2021. An Invitation to Negotiate (ITN) was advertised and publicly posted on March 8, 2021, with a closing date of April 13, 2021. Proposals were evaluated on several criteria, including the respondent's qualifications and experience, the technical proposal, and the financial proposal.

The ITN solicited proposals for a SaaS solution for the student information system. It was determined that a SaaS solution would provide the most stability for the SIS moving forward and would help to mitigate the risks associated with the current mainframe-based system.

A comprehensive evaluation team comprised of enterprise-wide stakeholders in academics, finance, and information technology reviewed responses to the ITN, selecting Workday, Inc. as the most responsive proposal to the needs of the University.

6. Review of Legal Documents

LSU Information Technology Services, LSU Procurement Services, and Office of General Counsel are currently developing the SIS contract based on the proposal submitted in response to the ITN.

7. Parties of Interest

Louisiana State University and Workday, Inc.

8. Related Transactions

Not Applicable

9. Conflicts of Interest

None known.

10. Attachments

None

RESOLUTION

NOW, THEREFORE, BE IT RESOLVED that the Board of Supervisors of Louisiana State University and Agricultural and Mechanical College does hereby authorize the President, or his designee, acting on behalf and in the name of the Board, and in consultation with general counsel, to execute the agreement with Workday, Inc. as determined by a competitive bid and evaluation process, with all such agreements and documents as well as any subsequent amendments thereto, to contain the terms and conditions, that the President deems in the best interest of LSU



Board of Supervisors

Request from LSU A&M to Authorize the Issuance of Auxiliary Revenue Refunding Bonds

Date: October 28-29, 2021

1. Bylaw Citation

Pursuant to Article VII, Section 1 J:

- J. Issuing any bonds or borrowing funds in any other manner, whether secured by the pledge of a revenue stream, property of the Board, or other means.

2. Summary of Matter

Pursuant to resolutions previously adopted by the Board, the Board, for the benefit of LSU, issued its (i) Auxiliary Revenue Refunding Bonds, Series 2021, (ii) Auxiliary Revenue Bonds, Series 2013, (iii) Auxiliary Revenue Bonds, Series 2014, and (iv) Auxiliary Revenue Refunding Bonds, Series 2016A (collectively, the "Prior Bonds"). Prevailing interest rates allow for savings in excess of the appropriate threshold of net present value interest savings recommended by the Louisiana State Bond Commission for economic refundings. LSU seeks to refund all or a portion of the Prior Bonds to decrease the overall debt service of LSU through the issuance of its Taxable Auxiliary Revenue Refunding Bonds (the "Bonds") in one or more series. As of October 1, 2021, financial models resulted in an estimated present value savings of \$8.6 million. The final determination as to whether all or a portion of the Prior Bonds will actually be refunded will depend on market conditions at the time the Bonds are priced and sold; however, LSU will seek to market the Bonds at such time as to take advantage of the best possible market conditions.

3. Review of Business Plan

See item 1. **Summary of the Matter** above.

4. Fiscal Impact

The financial consequences of this bond issue will have a beneficial impact on the general revenues of the LSU Student Union, Athletics, Residential Life, University Recreation and Parking & Transportation Services auxiliaries and the Lab School as a result of the interest cost savings accomplished by the refunding of the Prior Bonds and will not impede their ability to provide the basic services required of the respective departments.

5. Description of Competitive Process

Not Applicable

6. Review of Legal Documents

Legal documents will be reviewed by bond counsel and special counsel to the Board and by the Office of Accounting Services.

7. Parties of Interest

All of the parties relevant to the approval of the refunding of the Prior Bonds do not have any related interest in the refunding, nor will they receive any financial gain from this approval.

8. Related Transactions

The Board adopted resolutions on June 8, 2021, March 18, 2013, September 12, 2014, and October 21, 2016, issuing the respective series of the Prior Bonds.

9. Conflicts of Interest

None

10. Attachments

- I. Exhibit A - Form of Twentieth Supplemental Resolution
- II. Exhibit B - Form of Notice of Intention to Issue Bonds
- III. Exhibit C - Form of Preliminary Official Statement
- IV. Exhibit D - Form of Escrow Deposit Agreement
- V. Exhibit E - Form of Continuing Disclosure Certificate
- VI. Exhibit F - Form of Bond Purchase Agreement

RESOLUTION

NOW, THEREFORE, BE IT RESOLVED by the Board of Supervisors of Louisiana State University and Agricultural and Mechanical College (the "Board") that:

SECTION 1. Sections 2181 through 2193 and 3351(A)(4) of Title 17 and Chapter 14-A of Title 39 of the Louisiana Revised Statutes of 1950, as amended, and Article VII, Section 6(C) of the Constitution of the State of Louisiana of 1974 (collectively, the "Act"), and other constitutional and statutory authority, authorize the Board to borrow money and to issue bonds and refunding bonds and pledge revenues to guarantee payment thereof in accordance with law and with the approval of the Louisiana State Bond Commission (the "Commission"). The Board previously issued (i) \$41,615,000 original aggregate principal amount of its Auxiliary Revenue Refunding Bonds, Series 2012 (the "Series 2012 Bonds") (ii) \$101,180,000 original aggregate principal amount of its Auxiliary Revenue Bonds, Series 2013 (the "Series 2013 Bonds"), (iii) \$81,880,000 original aggregate principal amount of its Auxiliary Revenue Refunding Bonds, Series 2014 (the "Series 2014 Bonds"), and (iv) \$137,000,000 original aggregate principal amount of its Auxiliary Revenue Refunding Bonds, Series 2016A (the "Series 2016A Bonds" and, together with the Series 2012 Bonds, the Series 2013 Bonds and the Series 2014 Bonds, the "Prior Bonds") for the purposes of financing or refinancing various capital auxiliary projects on the campus of Louisiana State University and Agricultural and Mechanical College ("LSU"). The Board now desires to proceed with the refunding of all or a portion of the Prior Bonds. The Board does hereby authorize LSU to issue the Board's Taxable Auxiliary Revenue Refunding Bonds in one or more series in an aggregate principal amount not to exceed \$165,000,000 (the

"Bonds"), bearing interest at a fixed rate not to exceed six percent (6%) per annum with a maturity date not exceeding thirty (30) years from the date of issuance of the Bonds, for the purposes of (i) refunding all or a portion of the Prior Bonds, (ii) funding a reserve fund or paying the premium for a reserve fund insurance policy or surety bond, if necessary, and (iii) paying the costs of issuance of the Bonds, including, without limitation, the premium for a municipal bond insurance policy, if deemed to be financially advantageous to the Board, subject to the advice of special counsel and Bond Counsel (defined herein) to the Board and subject to the approval of the Commission.

SECTION 2. The Bonds shall be secured by the Auxiliary Revenues derived from certain Auxiliary Enterprises, including, without limitation, athletics, residential life, parking, the student union and other miscellaneous auxiliaries and certain other revenues that have been dedicated and pledged to payment of bonds on a parity with the Board's outstanding Series 2012 Bonds (to the extent not refunded by the Bonds), Series 2013 Bonds (to the extent not refunded by the Bonds), Series 2014 Bonds (to the extent not refunded by the Bonds), Series 2016A Bonds (to the extent not refunded by the Bonds), Series 2016B Bonds and Series 2019 Bonds, each as defined in the Board's General Bond Resolution adopted June 17, 1994, as supplemented and amended to date (the "General Bond Resolution").

SECTION 3. The President of LSU and the Interim Executive Vice President for Finance and Administration/CFO of LSU (each, individually, an "Authorized Board Representative" and, collectively, the "Authorized Board Representatives") and their designees have caused to be prepared by Bond Counsel (defined herein) and special counsel to the Board a Twentieth Supplemental Resolution (the "Twentieth Supplemental Resolution" and, together with the General Bond Resolution, the "Bond Resolution"), the form of which is attached hereto as **Exhibit A**, to supplement the General Bond Resolution with respect to the issuance of Bonds. The Board does hereby approve and adopt the Twentieth Supplemental Resolution in substantially the form attached hereto as **Exhibit A**, with such changes and modifications as are deemed in the best interest of the Board by the Authorized Board Representatives, including, without limitation, such changes as are recommended and/or required by the underwriters of the Bonds and by the pricing of the Bonds, and the Board does hereby ratify all prior actions taken on its behalf by LSU officials in furtherance of the issuance of the Bonds.

SECTION 4. The Board does hereby authorize the Authorized Representatives, their designees, Bond Counsel, and special counsel to the Board to proceed with the preparation of all documents necessary for the issuance of the Bonds, including, but not limited to the preparation and distribution of preliminary and final official statements, if any, related thereto and to obtain all consents and approvals necessary for the issuance of the Bonds.

SECTION 5. The Board hereby authorizes and approves all matters necessary in connection herewith, subject to advice of Bond Counsel and special counsel to the Board, including, but not limited to the publication of a Notice of Intention to issue the Bonds as provided in the Constitution, the form of which is attached hereto as **Exhibit B**, which is hereby approved with such additions, omissions and changes as may be approved by Bond Counsel to the Board.

SECTION 6. The Board hereby formally approves the making of its application to the Commission requesting that the Commission grant its approval to the issuance of the Bonds, all in accordance with applicable law and the rules of the Commission. The representatives of

LSU and Bond Counsel are hereby directed to furnish to and file with the Commission all documents, materials and information as may be necessary and appropriate in connection with the approval by the Commission of the issuance of the Bonds. A certified copy of this resolution shall be submitted to the Commission by the representatives of the Board or its Bond Counsel, with a letter requesting the prompt consideration and approval of this application and such letter may set forth and request approval by the Commission of the price at which such bonds may be sold and issued.

SECTION 7. It is hereby recognized, found and determined that a real necessity exists for the employment of bond counsel in connection with the issuance of the Bonds, and, accordingly, Breazeale, Sachse & Wilson, L.L.P., Baton Rouge, Louisiana ("Bond Counsel"), is hereby employed as bond counsel for the Board, to do and perform any and all legal work incidental and necessary with respect to the incurring of debt and issuance and sale of the Bonds. Bond Counsel shall prepare and submit to the Board for adoption the proceedings incidental to the authorization, issuance, sale, and delivery of the Bonds, and shall furnish its opinion covering the legality of the issuance thereof.

The fees to be paid to Bond Counsel with respect to Bonds actually issued, sold, delivered and paid for shall be based upon the then current fee schedule promulgated by the Attorney General of the State of Louisiana (at the time any such bonds are sold) with regard to fees for bond counsel for legal and coordinate professional work performed in connection with the issuance of revenue bonds by state entities. Such fees shall be payable out of the funds derived from the sale of the Bonds or other funds legally appropriated therefor.

SECTION 9. The Board hereby authorizes the marketing, pricing, and delivery of the Bonds; provided that the final terms of the Bonds shall meet the following conditions:

Principal amount in one or more series - Not to exceed \$165,000,000;

Maturity - Not to exceed 30 years;

Interest Rate - Not to exceed a fixed interest rate (taxable) of six percent (6.0%) per annum resulting in the appropriate threshold of net present value savings recommended by the Commission for an economic refunding.

SECTION 10. The Board does hereby authorize the execution and delivery by the Chair or Chair-Elect and the Secretary of the Board or the Interim Executive Vice President for Finance and Administration/CFO of LSU (each, individually, an "Authorized Signatory" and, collectively, the "Authorized Signatories") of (a) the Twentieth Supplemental Resolution in substantially the form attached as **Exhibit A** hereto, with such changes and modifications which are deemed in the best interest of the Board by the Authorized Board Representatives and which are necessary to reflect the final terms of the Bonds, including, without limitation, the need for a reserve fund insurance policy or surety bond and/or a municipal bond insurance policy, and (b) any and all such other documents, certificates or instruments necessary in connection with the marketing and issuance of the Bonds, including, without limitation, a preliminary official statement (and an official statement in the same form as the preliminary official statement updated to include the final pricing details of the Bonds), an Escrow Deposit Agreement, a Continuing Disclosure Certificate and a Bond Purchase Agreement between the Board and the underwriters of the Bonds, substantially in the respective forms attached hereto as **Exhibit C, D, E and F** hereto, with such changes and modifications which are deemed in the

best interest of the Board by the Authorized Board Representatives and which are necessary to reflect the final terms of the Bonds. The Authorized Signatories, the Authorized Board Representatives and their respective designees are further authorized to do all things necessary, on the advice of Bond Counsel and counsel to the Board, to effectuate and implement this Resolution and the Bond Resolution.

SECTION 11. By virtue of the Board's application for, acceptance and utilization of the benefits of the Louisiana State Bond Commission's approval(s) resolved and set forth herein, it resolves that it understands and agrees that such approval(s) are expressly conditioned upon, and it further resolves that it understands, agrees and binds itself, its successors and assigns to, full and continuing compliance with the "State Bond Commission Policy on Approval of Proposed Use of Swaps, or other forms of Derivative Products, Hedges, Etc.", adopted by the Commission on July 20, 2006, as to the borrowing(s) and other matter(s) subject to the approval(s), including subsequent application and approval under said Policy of the implementation or use of any swap(s) or other product(s) or enhancement(s) covered thereby.

SECTION 12. This resolution and the Notice of Intention to Issue Bonds shall be published one (1) time in the official journal of the Board. As provided by the Act, for a period of thirty (30) days from the date of publication of this resolution and the Notice of Intention to Issue Bonds, any person or persons in interest shall have the right to contest the legality of the Notice of Sale of Bonds, this resolution or other proceedings authorizing the issuance of the Bonds and the legality of the Bonds for any cause, after which time no one shall have any cause or right of action to contest the legality of this resolution or other proceedings or of the Bonds authorized thereby for any cause whatsoever.



Finance & Administration

DATE: October 15, 2021

TO: William F. Tate IV
President

FROM: Donna K. Torres 
Interim Executive Vice President for Finance and Administration/CFO

RE: Recommendation Requesting Approval to Refund All or a Portion of the Series 2012, 2013, 2014 and 2016A Auxiliary Revenue Bonds and Preliminary Approval to Issue Auxiliary Revenue Refunding Bonds

The recommendation attached is requesting the approval of the Board of Supervisors to advance refund all or a portion of the Series 2012, 2013, 2014, and 2016A Auxiliary Revenue Bonds in an amount not to exceed \$165,000,000 to take advantage of an estimated present value savings of \$8.6 million as of October 1, 2021. The savings will benefit the LSU Student Union, Athletics, Residential Life, University Recreation, the Laboratory School, and Parking & Transportation Services.

I respectfully request, should you concur, that the resolution be submitted for placement on the agenda for the October 2021 meeting of the Board of Supervisors.

Please let me know if you have additional questions. Thank you.

Attachments

**BOARD OF SUPERVISORS
OF
LOUISIANA STATE UNIVERSITY
AND AGRICULTURAL AND MECHANICAL COLLEGE**

**\$ _____
BOARD OF SUPERVISORS OF LOUISIANA STATE UNIVERSITY
AND AGRICULTURAL AND MECHANICAL COLLEGE
Taxable Auxiliary Revenue Refunding Bonds
Series 2022**

TWENTIETH SUPPLEMENTAL RESOLUTION

APPROVED OCTOBER 29, 2021
EXECUTED _____, 2022

TWENTIETH SUPPLEMENTAL RESOLUTION

TABLE OF CONTENTS

* * * * *

ARTICLE I

DEFINITIONS; AMENDMENT; FINDINGS AND INTERPRETATION

SECTION 1.01. Definitions.....3
SECTION 1.02. Interpretation.....11
SECTION 1.03. Redemption of Refunded Bonds.....12
SECTION 1.04. Sale of the Series 2022 Bonds.12
SECTION 1.05. Ratification and Approval of Preliminary Official Statement, Approval of
Official Statement, Purchase Agreement and other documents.....12
SECTION 1.06. Authorized Officers.13

ARTICLE II

AUTHORIZATION AND DETAILS OF THE SERIES 2022 BONDS

SECTION 2.01. Authorization.14
SECTION 2.02. Form; Denominations; Date; Limited Obligations.14
SECTION 2.03. Payment of Principal and Interest of Series 2022 Bonds; Acceptance of
Terms and Conditions.15
SECTION 2.04. Initial Delivery of Series 2022 Bonds.....16
SECTION 2.05. Book-Entry System.....17
SECTION 2.06. Appointment of Trustee and Paying Agent; Removal of the Trustee and
Successor Trustee.....18
SECTION 2.07. Disposition of Proceeds of the Series 2022 Bonds and Other Funds of the
Board.....19

ARTICLE III

REDEMPTION

SECTION 3.01. Extraordinary Optional Redemption of the Series 2022 Bonds.....20
SECTION 3.02. Optional Redemption.....20
SECTION 3.03. Mandatory Sinking Fund Redemption.....20
SECTION 3.04. Notice of Redemption of Series 2022 Bonds.....21
SECTION 3.05. Effect of Redemption.....22

ARTICLE IV

PLEDGE OF AUXILIARY REVENUES

SECTION 4.01. Pledge and Payments.24

SECTION 4.02.	Rate Covenant.....	24
---------------	--------------------	----

ARTICLE V

BOND INSURANCE PROVISIONS; ADDITIONAL COVENANTS

SECTION 5.01.	Insurer Deemed Sole Holder of Series 2022 Bonds for Certain Purposes	25
SECTION 5.02.	Consent of Insurer Required for Acceleration of Maturity.....	25
SECTION 5.03.	Grace Periods for Defaults.....	25
SECTION 5.04.	Third Party Beneficiary.....	25
SECTION 5.05.	Selection of Bonds for Redemption.....	25
SECTION 5.06.	Amendments, Supplements, Modifications and Waivers.....	26
SECTION 5.07.	Exercise of Insurer's Contractual Rights.....	26
SECTION 5.08.	Defeasance of Insured Bonds.....	26
SECTION 5.09.	Amounts Paid by Insurer	27
SECTION 5.10.	Claims upon the Insurance Policy and Payments by and to the Insurer	27
SECTION 5.11.	Rights of Subrogation	28
SECTION 5.12.	Payment or Reimbursement of Insurer	28
SECTION 5.13.	Insurer Entitled to Pay Principal or Interest on the Insured Bonds	29
SECTION 5.14.	Insurer Notice Address	29
SECTION 5.15.	Information Requirements	29
SECTION 5.16.	Access to Key Personnel, Facilities and Records	30
SECTION 5.17.	Determinations of Adverse Effects on the Insurance Policy	30
SECTION 5.18.	No Impairment of Security	30
SECTION 5.19.	Loss by the Insurer of Certain Rights	30

ARTICLE VI

FUNDS AND ACCOUNTS

SECTION 6.01.	Creation of Funds and Accounts.....	32
SECTION 6.02.	Series 2022 Bond Proceeds Fund.	32
SECTION 6.03.	Intentionally Left Blank.....	32
SECTION 6.04.	Series 2022 Costs of Issuance Account of the Series 2022 Bond Proceeds Fund.	32
SECTION 6.05.	Series 2022 Interest Account and Series 2022 Principal Account.....	32
SECTION 6.06.	Investments and Earnings on Certain Funds and Accounts and Valuation Thereof.....	33

ARTICLE VII

MISCELLANEOUS

SECTION 7.01.	Twentieth Supplemental Resolution to Constitute Contract.....	34
SECTION 7.02.	Conflicts with General Bond Resolution.....	34
SECTION 7.03.	Notices.....	34
SECTION 7.04.	Notices to Moody's and Fitch.	35

SECTION 7.05.	Continuing Disclosure.	35
SECTION 7.06.	Parties Interested Herein.	35
SECTION 7.07.	Effective Date.	35
SECTION 7.08.	Disqualified Series 2022 Bonds.....	36
SECTION 7.09.	Electronic Transmissions.	36

* * * * *

EXHIBIT A	SERIES 2022 BOND FORM
EXHIBIT B	REQUISITION FORM TO PAY SERIES 2022 COSTS OF ISSUANCE
EXHIBIT C-1	SERIES 2012 REFUNDED BONDS
EXHIBIT C-2	SERIES 2013 REFUNDED BONDS
EXHIBIT C-3	SERIES 2014 REFUNDED BONDS
EXHIBIT C-4	SERIES 2016A REFUNDED BONDS
EXHIBIT D-1	FORM OF NOTICE OF REDEMPTION FOR SERIES 2012 REFUNDED BONDS
EXHIBIT D-2	FORM OF NOTICE OF REDEMPTION FOR SERIES 2013 REFUNDED BONDS
EXHIBIT D-3	FORM OF NOTICE OF REDEMPTION FOR SERIES 2014 REFUNDED BONDS
EXHIBIT D-4	FORM OF NOTICE OF REDEMPTION FOR SERIES 2016A REFUNDED BONDS

**BOARD OF SUPERVISORS
OF
LOUISIANA STATE UNIVERSITY
AND AGRICULTURAL AND MECHANICAL COLLEGE**

**Twentieth Supplemental Resolution
(the "*Twentieth Supplemental Resolution*")**

A Twentieth Supplemental Resolution supplementing the General Bond Resolution adopted on June 17, 1994, as previously supplemented and amended; providing for the issuance of _____ and No/100 Dollars (\$_____) principal amount of Board of Supervisors of Louisiana State University and Agricultural and Mechanical College Taxable Auxiliary Revenue Refunding Bonds, Series 2022 pursuant to said General Bond Resolution and this Twentieth Supplemental Resolution; approving and confirming the sale of such bonds; prescribing the form, fixing the details and providing for the payment of principal of and interest on such bonds and the application of the proceeds thereof; and providing for other matters in connection therewith.

WHEREAS, Sections 2181 through 2193 and 3351(A)(4) of Title 17 of the Louisiana Revised Statutes of 1950, as amended, Chapter 14-A of Title 39 of the Louisiana Revised Statutes of 1950, as amended, Article VII, Section 6(C) of the Constitution of the State of Louisiana of 1974 (collectively, the "*Act*"), and other constitutional and statutory authority authorize the Board of Supervisors of Louisiana State University and Agricultural and Mechanical College (the "*Board*" or the "*Issuer*") to borrow money and to issue bonds and refunding bonds and to pledge revenues to guarantee payment thereof in accordance with law and with approval of the State Bond Commission; and

WHEREAS, the Board adopted a General Bond Resolution on June 17, 1994 (as supplemented and amended to the date hereof, the "*General Bond Resolution*") authorizing the issuance of revenue bonds of the Board on the terms and conditions set forth in the General Bond Resolution; and

WHEREAS, the General Bond Resolution provides that the details of the Bonds of each Series issued thereunder shall be specified in a supplemental resolution adopted by the Board authorizing the issuance of such Series of Bonds, subject to the terms, conditions and limitations established in the General Bond Resolution; and

WHEREAS, the Board desires to avail itself of the provisions of the Act and the General Bond Resolution through the incurrence of debt and issuance of its Taxable Auxiliary Revenue Refunding Bonds, Series 2022, in an aggregate principal amount of \$_____ (the "*Series 2022 Bonds*"), for the purpose of[**, together with available funds of the Board,**] (i) refunding (a) [all/a portion] of the Board's outstanding Series 2012 Bonds, (b) [all/a portion] of the Board's outstanding Series 2013 Bonds, (c) [all/a portion] of the Board's outstanding Series 2014 Bonds and (d) [all/a portion] of the Board's outstanding Series 2016A Bonds (each as defined below and, collectively, the "*Refunded Bonds*"), (ii) [**funding a reserve fund or paying the premium for a reserve fund insurance policy or surety bond, and (iii)**] paying the costs of issuance of the

Series 2022 Bonds[**, including the premium for a bond insurance policy**], all subject to the terms and conditions contained in the Bond Resolution (defined herein); and

WHEREAS, to accomplish the refunding of the Refunded Bonds, the Board and The Bank of New York Mellon Trust Company, N.A. (the "*Escrow Trustee*") will enter into an Escrow Deposit Agreement dated the date of issuance of the Series 2022 Bonds (the "*Escrow Agreement*"); and

WHEREAS, the Series 2022 Bonds will be issued pursuant the General Bond Resolution and this Twentieth Supplemental Resolution (collectively, the "*Bond Resolution*"), and Chapter 14-A of Title 39 of the Louisiana Revised Statutes of 1950, as amended, (the "*Refunding Act*"); and

WHEREAS, pursuant to a resolution adopted by the Board at its meeting of October 29, 2021 (the "*Authorization Resolution*"), the Board made application to the State Bond Commission for authority to proceed with the sale of the Series 2022 Bonds to accomplish the refunding of the Refunded Bonds and approved certain parameters for the terms of the Series 2022 Bonds and the issuance thereof within such parameters; and

WHEREAS, the State Bond Commission authorized and approved the issuance of the Series 2022 Bonds at its meeting on November 18, 2021; and

WHEREAS, the Board now desires to incur debt and to issue the Series 2022 Bonds under the General Bond Resolution and this Twentieth Supplemental Resolution in the manner authorized and provided by the Refunding Act, as hereinafter provided, to provide funds[**, together with available funds of the Board,**] for the purpose of refunding the Refunded Bonds and paying costs of issuance of the Series 2022 Bonds, and the Series 2022 Bonds shall be payable from and secured by the Auxiliary Revenues, defined herein, which are derived from self-generated revenues from students and the public at large who utilize Auxiliary Facilities, defined herein; and

WHEREAS, the Board has previously issued its (i) \$41,615,000 in original aggregate principal amount of Auxiliary Revenue Refunding Bonds, Series 2012 (the "*Series 2012 Bonds*"), pursuant to the Fifteenth Supplemental Resolution approved June 8, 2012, effective August 7, 2012, (ii) \$101,180,000 in original aggregate principal amount of Auxiliary Revenue Bonds, Series 2013 (the "*Series 2013 Bonds*"), pursuant to the Sixteenth Supplemental Resolution approved March 18, 2013, and effective April 25, 2013, (iii) \$81,880,000 in original aggregate principal amount of Auxiliary Revenue Refunding Bonds, Series 2014 (the "*Series 2014 Bonds*"), pursuant to the Seventeenth Supplemental Resolution approved September 12, 2014, and effective October 16, 2014, (iv) \$137,000,000 in original aggregate principal amount of Auxiliary Revenue Bonds, Series 2016A (the "*Series 2016A Bonds*") pursuant to the Eighteenth Supplemental Resolution approved October 21, 2016, and executed November 15, 2016, (v) \$16,320,000 in original aggregate principal amount of Taxable Auxiliary Revenue Bonds, Series 2016B (the "*Series 2016B Bonds*") pursuant to the Eighteenth Supplemental Resolution approved October 21, 2016, and executed November 15, 2016, and (vii) \$72,355,000 in original aggregate principal amount of Taxable Auxiliary Revenue Refunding Bonds, Series 2019 (the "*Series 2019 Bonds*") pursuant to the Nineteenth Supplemental Resolution approved

October 25, 2019, and executed December 18, 2019, and all issued pursuant to the General Bond Resolution (collectively, but not including the Refunded Bonds, the "*Outstanding Parity Bonds*"); and

NOW, THEREFORE, BE IT RESOLVED by the Board that:

ARTICLE I

DEFINITIONS; AMENDMENT; FINDINGS AND INTERPRETATION

SECTION 1.01. *Definitions.* Unless the context shall clearly indicate some other meaning or unless otherwise defined herein, all words and terms used in this Twentieth Supplemental Resolution which are defined in the General Bond Resolution adopted by this Board on June 17, 1994, as amended to the date hereof, entitled: "A resolution authorizing and providing for the incurring of debt and issuance from time to time of revenue bonds, of the Board of Supervisors of Louisiana State University and Agricultural and Mechanical College payable from gross revenues of certain auxiliary enterprises; prescribing the form, fixing the details and conditions of such revenue bonds and providing for the payment of the principal and interest thereon and other matters in connection therewith," shall, for all purposes of this Twentieth Supplemental Resolution, have the respective meanings given to them in the General Bond Resolution. In addition, unless the context shall clearly indicate some other meaning, the following terms shall, for all purposes of the Bond Resolution, have the following meanings:

"*Act*" shall have the meaning assigned thereto in the recitals to this Twentieth Supplemental Resolution.

"*Authorization Resolution*" means the resolution adopted by the Board on October 29, 2021, granting authorization to proceed with the sale of the Series 2022 Bonds, making application to the State Bond Commission and approving certain parameters for the terms of the Series 2022 Bonds and the issuance thereof within such parameters.

"*Authorized Board Representative*" means, with respect to the Series 2022 Bonds and any document relating thereto, one or more, as required by law or by the Bond Resolution, of the Chairman, the Chairman-Elect, the Secretary and each officer of the Board, the President and the Executive Vice President or any other Person designated in writing to the Trustee by the Chairman or Chairman-Elect of the Board or designated by a resolution of the Board.

"*Authorized Denominations*" means, with respect to the Series 2022 Bonds, \$5,000 and any integral multiple hereof.

"*Beneficial Owner*" or "*Owner*" means, with respect to the Series 2022 Bonds, a Person owning a Beneficial Ownership Interest therein, as evidenced to the satisfaction of the Trustee.

"*Beneficial Ownership Interest*" means the beneficial right to receive payments and notices with respect to the Series 2022 Bonds which are held by the Depository under a book entry system.

"*Board*" means the Board of Supervisors of Louisiana State University and Agricultural and Mechanical College, and its successors and assigns.

"*Board Documents*" means collectively, the General Bond Resolution, this Twentieth Supplemental Resolution, the Continuing Disclosure Certificate, the Escrow Agreement and the Purchase Agreement.

"*Bond Resolution*" means, with respect to the Series 2022 Bonds, the General Bond Resolution, as heretofore supplemented and amended, and as additionally supplemented by this Twentieth Supplemental Resolution.

"*Bond Year*" shall mean, with respect to the Series 2022 Bonds, the twelve (12) month period commencing at 12:01 a.m. on July 1 of each year and ending at midnight the succeeding June 30 or, at the discretion of the Board, any other twelve (12) month period, provided that the first Bond Year shall commence on the date of delivery of the Series 2022 Bonds and end at midnight on June 30, 2020.

"*Book Entry Form*" or "*book entry system*" means a form or system, as applicable, under which (i) the Beneficial Ownership Interests may be transferred only through a book entry and (ii) physical Series 2022 Bonds certificates in fully registered form are registered only in the name of a Depository or its nominee as Holder, with the physical Series 2022 Bonds certificates "immobilized" in the custody of the Depository. The book entry system maintained by and the responsibility of the Depository and not maintained by or the responsibility of the Board or the Trustee is the record that identifies, and records the transfer of the interests of, the owners of book entry interests in the Series 2022 Bonds.

"*Business Day*" means a day other than (i) a Saturday, Sunday or legal holiday in the cities in which the principal offices of the Board and the Trustee are located or (ii) a day on which the New York Stock Exchange is closed.

"*Cede & Co.*" means Cede & Co., the nominee of DTC, and any successor nominee of DTC with respect to the Series 2022 Bonds.

"*Code*" shall mean the Internal Revenue Code of 1986, as the same may be amended from time to time.

"*Continuing Disclosure Certificate*" means the Continuing Disclosure Certificate, dated the date of delivery of the Series 2022 Bonds, of the Board.

"*Debt Service Requirements*" means for any particular Fiscal Year with respect to all Bonds or a particular Series of Bonds, as applicable, an amount equal to the sum of (a) all interest payable during such Fiscal Year on such Outstanding Bonds, plus (b) the Principal Installment of such Outstanding Bonds falling due during such Fiscal Year, calculated on the assumption that such Outstanding Bonds on the day of calculation cease to be outstanding by reason of payment either upon maturity or by application of any scheduled Sinking Fund Installments as provided for in a Supplemental Resolution. In the case of Variable Rate Debt, with respect to a particular Fiscal Year, the interest rate thereon shall be calculated on the assumption that such Series of Bonds will bear interest during such period at the maximum rate

that may be borne by such Variable Rate Debt; provided that, if on such date of calculation the interest rate on such Variable Rate Debt shall then be fixed for a specified period, the interest rate used for such specified period for the purposes of the foregoing calculation shall be such actual interest rate. Such interest and Principal Installments for a Series of Bonds shall be calculated on the assumption that no Bonds Outstanding at the date of calculation will cease to be Outstanding except by reason of the payment of each Principal Installment on the due date thereof.

"*Defeasance Obligations*" means, with respect to the Series 2022 Bonds, the obligations listed in subparagraphs (1) and (2) under the definition of "Permitted Investments" in this Section 1.01.

"*Depository*" means any securities depository that is a clearing agency under federal law operating and maintaining, with its participants or otherwise, a book entry system to record ownership of book entry interests in Series 2022 Bonds, and to effect transfers of book entry interests in the Series 2022 Bonds in book entry form, and includes and means, initially, DTC.

"*DTC*" means The Depository Trust Company, a limited-purpose trust company organized under the laws of the State of New York, and its successors and assigns, including any successor securities depository appointed pursuant to Section 2.05.

"*DTC Representation Letter*" means the Blanket Letter of Representation from the Board to DTC with respect to the Series 2022 Bonds, or any agreement between the Board and/or the Trustee and a successor securities depository appointed pursuant to Section 2.05, in either case as from time to time amended.

"*Eighteenth Supplemental Resolution*" means the Eighteenth Supplemental Resolution approved by the Board on October 21, 2016, and executed and effective November 15, 2016, pursuant to which the Series 2016A Bonds were issued.

"*Electronic Means*" means the following communications methods: e-mail, facsimile transmission, secure electronic transmission containing applicable authorization codes, passwords and/or authentication keys issued by the Trustee, or another method or system specified by the Trustee as available for use in connection with its services hereunder.

"*EMMA*" means the Municipal Securities Rulemaking Board's Electronic Municipal Market Access Center at www.emma.msrb.org.

"*Escrow Agreement*" means the Escrow Agreement (Series 2012, Series 2013, Series 2014 and Series 2016A) dated the date of issuance of the Series 2022 Bonds between the Board and the Escrow Trustee providing for the refunding of the Refunded Bonds.

"*Escrow Fund*" means, collectively, the Series 2012 Escrow Account, the Series 2013 Escrow Account, the Series 2014 Escrow Account and the Series 2016A Escrow Account.

"*Escrow Trustee*" shall mean The Bank of New York Mellon Trust Company, N.A., [**Jacksonville, Florida,**] or any successor thereto, as Escrow Trustee under the Escrow Agreement.

"*Executive Vice President*" means the Executive Vice President for Finance and Administration and Chief Financial Officer of the University and shall include any permanent or interim officer or any successor office.

"*Fiscal Year*" means the twelve month period beginning on July 1 of any year and ending on June 30 of the following year.

"*Fitch*" means Fitch Ratings, a Delaware corporation, its successors and assigns, and, if such corporation shall for any reason no longer perform the functions of a securities rating agency, "Fitch" shall be deemed to refer to any other nationally recognized securities rating agency designated by the Board.

"*Fifteenth Supplemental Resolution*" means the Fifteenth Supplemental Resolution adopted by the Board on June 8, 2012, and executed and effective on August 7, 2012, pursuant to which the Series 2012 Bonds were issued.

"*Funds and Accounts*" means the Funds and Accounts created pursuant to Article VII of the General Bond Resolution or pursuant to this Twentieth Supplemental Resolution.

"*General Bond Resolution*" means the General Bond Resolution adopted by the Board on June 17, 1994, as amended to the date hereof.

[**"*Insurance Policy*" means the insurance policy issued by the Insurer guaranteeing the scheduled payment of principal of and interest on the Insured Bonds when due.

"*Insured Bonds*" means the Series 2022 Bonds.

"*Insurer*" means _____, or any successor thereto or assignee thereof.**]

"*Interest Payment Dates*" means January 1 and July 1 of each year commencing July 1, 2022.

"*Issuer*" means the Board of Supervisors of Louisiana State University and Agricultural and Mechanical College, and its successors and assigns.

"*Lab School*" means the University Lab School, a K-12 public educational facility located on the campus of the University and operated by the University.

"*Lab School Revenues*" means the revenues derived by the Lab School from a \$500 tuition increase effective with the 2000-01 school year and a \$265 tuition increase effective with the 2001-02 school year in accordance with House Bill No. 1920 of the 1999 Regular Session of the Louisiana Legislature and with a resolution adopted by the Board on July 16, 1999.

"*Maturity Date*" means with respect to the Series 2022 Bonds, the maturity dates set forth in Section 2.02(b) hereof.

"*Moody's*" means Moody's Investors Service, Inc., a corporation duly organized and existing under and by virtue of the laws of the State of Delaware, and its successors and assigns,

except that if such corporation shall be dissolved or liquidated or shall no longer perform the functions of a securities rating agency, then the term "Moody's" shall be deemed to refer to any other nationally recognized securities rating agency selected by the Board.

"*Outstanding*," "*Outstanding Bonds*" or "*Bonds Outstanding*" when used as of a particular time with reference to the Series 2022 Bonds, means (subject to Section 7.08 hereof) all the Series 2022 Bonds delivered under this Twentieth Supplemental Resolution except:

(i) Series 2022 Bonds cancelled by the Trustee or surrendered to the Trustee for cancellation;

(ii) Series 2022 Bonds paid or deemed to have been paid within the meaning of Article XIII of the General Bond Resolution; and

(iii) Series 2022 Bonds in lieu of or in substitution for which replacement Series 2022 Bonds shall have been executed by the Board and delivered by the Trustee hereunder.

"*Outstanding Parity Bonds*" shall have the meaning assigned thereto in the recitals to this Twentieth Supplemental Resolution.

"*Participants*" means brokers, dealers, banks and other financial institutions and other Persons for whom from time to time DTC effects book-entry transfers and pledges of securities deposited with DTC.

"*Paying Agent*" means the Trustee for purposes of this Twentieth Supplemental Resolution and the Series 2022 Bonds.

"*Permitted Investments*" means, with respect to the Series 2022 Bonds, the following, to the extent permitted by applicable law:

(1) Cash (insured at all times by the Federal Deposit Insurance Corporation or otherwise collateralized with obligations described in paragraph (2) below);

(2) Direct obligations of (including obligations issued or held in book-entry form on the books of) the Department of the Treasury of the United States of America;

(3) Obligations of any of the following federal agencies which obligations represent full faith and credit of the United States of America:

- Export-Import Bank
- Farm Credit System Financial Assistance Corporation
- Rural Economic Community Development Administration (formerly the Farmers Home Administration)
- General Services Administration
- U.S. Maritime Administration

- Small Business Administration
- Government National Mortgage Association (GNMA)
- U.S. Department of Housing and Urban Development (PHA's)
- Federal Housing Administration
- Federal Financing Bank;

(4) Direct obligations of any of the following federal agencies which obligations are not fully guaranteed by the full faith and credit of the United States of America:

- Senior debt obligations rated "Aa" by Moody's and "AA" by S&P issued by the Federal National Mortgage Association (FNMA) or the Federal Home Loan Mortgage Corporation (FHLMC)
- Senior debt obligations of the Federal Home Loan Bank System
- Senior debt obligations of other Government Sponsored Agencies;

(5) U.S. dollar denominated deposit accounts, federal funds and banker's acceptances with domestic commercial banks which have a rating on their short-term certificates of deposit on the date of purchase of "A-1+" by S&P and "P-1" by Moody's and maturing no more than 360 days after the date of purchase (ratings on holding companies are not considered as the rating of the bank);

(6) Commercial paper which is rated at the time of purchase in the single highest classification, "A-1+" by S&P and "P-1" by Moody's, and which matures not more than 270 days after the date of purchase;

(7) Investments in a money market fund rated "AAAm" or "AAAm-G" or better by S&P;

(8) Pre-refunded Municipal Obligations defined as follows: any bonds or other obligations of any state of the United States of America or of any agency, instrumentality or local governmental unit of any such state which are not callable at the option of the obligor prior to maturity or as to which irrevocable instructions have been given by the obligor to call on the date specified in the notice; and

(A) which are rated, based on an irrevocable escrow account or fund (the "escrow"), in the highest rating category of S&P and Moody's or any successors thereto; or

(B) (i) which are fully secured as to principal and interest and redemption premium, if any, by an escrow consisting only of cash or obligations described in paragraph (A)(2) above, which escrow may be applied only to the payment of such principal of and interest and redemption premium, if any, on such bonds or other obligations on the maturity date or dates thereof or the specified redemption date or dates pursuant to such irrevocable instructions, as appropriate, and (ii) which escrow is sufficient, as verified by a nationally

recognized independent certified public accountant, to pay principal of and interest and redemption premium, if any, on the bonds or other obligations described in this paragraph on the maturity or redemption date or dates specified in the irrevocable instructions referred to above, as appropriate;

(9) General obligations and revenue bonds of any state of the United States of America with a rating of at least "A2/A" or higher by both Moody's and S&P; and

(10) Investment agreements (supported by appropriate opinions of counsel).

"*President*" means the President of the University and shall include any permanent or interim officer or any successor office.

"*Principal Payment Date*" means July 1 of each year, commencing July 1, 2022.

"*Purchase Agreement*" means the Bond Purchase Agreement dated _____, 2022, between the Board and the Underwriter.

"*Record Date*" means the fifteenth (15th) day (whether or not a Business Day) of the month next preceding each Interest Payment Date.

"*Recreational Sports Fee Revenues*" means (a) the \$15.00 per fall and spring semesters increase and \$5.00 per summer semester increase in the self-assessed student recreational sports fee authorized by the Board by its resolution adopted May 31, 2002 and (b) (i) the \$20.00 per summer semester increase to be imposed beginning summer semester of the 2012-13 academic year, (ii) the \$45.00 per fall and spring semesters increase and \$20.00 per summer semester increase to be imposed beginning fall semester of the 2013-14 academic year, (iii) the \$45.00 per fall and spring semesters increase and \$20.00 per summer semester increase to be imposed beginning fall semester of the 2014-15 academic year and (iv) the \$45.00 per fall and spring semesters increase to be imposed beginning fall semester of the 2015-16 academic year in the student recreational sports fee authorized by the Board by its resolution adopted February 1, 2013, such that the total summer semester fee in 2015 and thereafter will be \$85 and the total fall and spring semester fee in 2015-2016 and thereafter will be \$200.

"*Redemption Date*" shall have the meaning assigned thereto in Section 1.03 hereof.

"*Refunded Bonds*" means, collectively the Series 2012 Bonds, the Series 2013 Bonds, the Series 2014 Bonds and the Series 2016A Bonds being refunded using proceeds of the Series 2022 Bonds, as more fully described in **Exhibits C-1, C-2, C-3 and C-4** hereto.

"*Requisition (2022 Costs of Issuance)*" means the Payment Requisition Form, in the form attached as **Exhibit B** to this Twentieth Supplemental Resolution to be submitted for payment of 2022 Costs of Issuance.

"*S&P*" means S&P Global Ratings, a division of S&P Global, duly organized and existing under and by virtue of the laws of the State of New York, and its successors and assigns,

except that if such corporation shall be dissolved or liquidated or shall no longer perform the functions of a securities rating agency, then the term "S&P" shall be deemed to refer to any other nationally recognized securities rating agency selected by the Board.

"*Series 2012 Bonds*" shall have the meaning assigned thereto in the preambles of this Twentieth Supplemental Resolution.

"*Series 2012 Escrow Account*" means the Escrow Account (Series 2012) established in the Escrow Agreement.

"*Series 2012 Refunded Bonds*" means Series 2012 Bonds refunded by the Series 2022 Bonds, as more fully described in **Exhibit C-1**.

"*Series 2013 Bonds*" shall have the meaning assigned thereto in the preambles of this Twentieth Supplemental Resolution.

"*Series 2013 Escrow Account*" means the Escrow Account (Series 2013) established in the Escrow Agreement.

"*Series 2013 Refunded Bonds*" means Series 2013 Bonds refunded by the Series 2022 Bonds, as more fully described in **Exhibit C-2**.

"*Series 2014 Bonds*" shall have the meaning assigned thereto in the preambles of this Twentieth Supplemental Resolution.

"*Series 2014 Escrow Account*" means the Escrow Account (Series 2014) established in the Escrow Agreement.

"*Series 2014 Refunded Bonds*" means Series 2014 Bonds refunded by the Series 2022 Bonds, as more fully described in **Exhibit C-3**.

"*Series 2016A Bonds*" shall have the meaning assigned thereto in the preambles of this Twentieth Supplemental Resolution.

"*Series 2016A Escrow Account*" means the Escrow Account (Series 2016) established in the Escrow Agreement.

"*Series 2016A Refunded Bonds*" means Series 2016A Bonds refunded by the Series 2022 Bonds, as more fully described in **Exhibit C-4**.

"*Series 2022 Bonds*" means the Taxable Auxiliary Revenue Refunding Bonds, Series 2022, issued by the Board in the aggregate principal amount of \$_____ pursuant to the Bond Resolution.

"*Series 2022 Bond Proceeds Fund*" means the account by that name created pursuant to Section 6.01 hereof.

"*Series 2022 Costs of Issuance Account*" means the account by that name created within the Bond Proceeds Fund pursuant to Section 6.01 hereof.

"*Series 2022 Sinking Fund*" means the Series 2019 Principal Account and the Series 2019 Interest Account of the Bond Fund.

"*Series 2022 Interest Account*" means the Account by that name created within the Bond Fund pursuant to Section 6.01 hereof.

"*Series 2022 Principal Account*" means the Account by that name created within the Bond Fund pursuant to Section 6.01 hereof.

"*Seventeenth Supplemental Resolution*" means the Seventeenth Supplemental Resolution approved by the Board on September 12, 2014, and executed and effective October 16, 2014, pursuant to which the Series 2014 Bonds were issued.

"*Sinking Fund Amounts*" shall have the meaning assigned thereto in Section 3.03 hereof.

"*Sinking Fund Installment*" means the payment by the Board of Sinking Fund Amounts, when due, to the appropriate Account of the Bond Fund.

"*Sixteenth Supplemental Resolution*" means the Sixteenth Supplemental Resolution approved by the Board on March 8, 2013, and executed and effective April 25, 2013, pursuant to which the Series 2013 Bonds were issued.

"*Trustee*" means The Bank of New York Mellon Trust Company, N.A., Jacksonville, Florida, or any successor thereto, as trustee and Paying Agent hereunder.

"*Twentieth Supplemental Resolution*" means this Twentieth Supplemental Resolution approved by the Board on October 29, 2021, and executed and effective _____, 2022, pursuant to which the Series 2022 Bonds are issued.

"*2022 Costs of Issuance*" means all items of expense, directly or indirectly payable or reimbursable and related to the authorization, sale and issuance of the Series 2022 Bonds including, but not limited to, publication costs, printing costs, costs of preparation and reproduction of documents, filing and recording fees, initial fees and charges of any fiduciary, legal fees and charges, fees and disbursements of consultants and professionals, costs of credit ratings, bond insurance premiums, fees and costs of preparing preliminary and final official statements, fees and charges for preparation, execution, transportation and safekeeping of the Series 2022 Bonds and any other cost, charge or fee in connection with the original sale and issuance of the Series 2022 Bonds.

"*2022 Undertaking*" shall have the meaning assigned thereto in Section 7.05 hereof.

"*Underwriter*" means the underwriter designated in the Purchase Agreement.

SECTION 1.02. ***Interpretation.*** Unless or except as the context shall clearly indicate otherwise or may otherwise require in this Twentieth Supplemental Resolution: (i) all references

to a particular section, paragraph or subdivision of the General Bond Resolution or this Twentieth Supplemental Resolution, as the case may be, are to be the corresponding section, paragraph or subdivision of the General Bond Resolution only or this Twentieth Supplemental Resolution only, as the case may be; (ii) the terms "herein," "hereunder," "hereby," "hereto," "hereof" and any similar terms refer to this Twentieth Supplemental Resolution only, and to this Twentieth Supplemental Resolution as a whole and not to any particular section, paragraph or subdivision thereof; (iii) the terms "therein," "thereunder," "thereby," "thereto," "thereof" and any similar terms refer to the General Bond Resolution, and to the General Bond Resolution as a whole and not to any particular section, paragraph or subdivision thereof; and (iv) the term "heretofore" means before the time of effectiveness of this Twentieth Supplemental Resolution and the term "hereafter" means after the time of the effectiveness of this Twentieth Supplemental Resolution.

SECTION 1.03. ***Redemption of Refunded Bonds.*** The Board hereby authorizes the redemption of (i) the Series 2012 Refunded Bonds on July 1, 2022, (ii) the Series 2013 Refunded Bonds on July 1, 2023, (iii) the Series 2014 Refunded Bonds on July 1, 2024, and (iv) the Series 2016A Refunded Bonds on July 1, 2026 (each a "*Redemption Date*"), and each at a price of 100% of the principal amount thereof plus accrued interest to the respective Redemption Dates, and directs The Bank of New York Mellon Trust Company, N.A., as trustee for the Refunded Bonds, to give notice thereof in the forms attached as **Exhibit D-1, Exhibit D-2, Exhibit D-3** and **Exhibit D-4** hereto at the time and in the manner provided for therein and in the Fifteenth Supplemental Resolution, the Sixteenth Supplemental Resolution, the Seventeenth Supplemental Resolution and the Eighteenth Supplemental Resolution, as applicable.

SECTION 1.04. ***Sale of the Series 2022 Bonds.*** The selection of the Underwriter by an Authorized Board Representative is hereby approved and ratified. The sale of the Series 2022 Bonds to the Underwriter pursuant to the Purchase Agreement at the purchase price stated therein is hereby approved. The execution, delivery and performance of the Purchase Agreement are hereby approved, and an Authorized Board Representative is hereby directed to execute and deliver the Purchase Agreement and all Board Documents.

SECTION 1.05. ***Ratification and Approval of Preliminary Official Statement, Approval of Official Statement, Purchase Agreement and other documents.***

(a) In connection with the issuance and sale of the Series 2022 Bonds, there have been prepared and submitted to this meeting forms of:

(i) a draft of the Preliminary Official Statement (the "*Preliminary Official Statement*"), to be used in connection with the marketing of the Series 2022 Bonds;

(ii) a draft of the final Official Statement (the "*Official Statement*"), substantially in the form of the Preliminary Official Statement, to be used in connection with the sale of the Series 2022 Bonds;

(iii) a draft of the Purchase Agreement; and

(iv) a draft of the Escrow Agreement.

(b) The Preliminary Official Statement in the form presented to this meeting and made a part hereof as though set forth in full herein, is hereby approved and its use by the Underwriter and the delivery of the "Rule 15c2-12 Certificate" by the Executive Vice President to the Underwriter are hereby approved in connection with the public offering and marketing of the Series 2022 Bonds.

(c) The Official Statement in substantially the form of the Preliminary Official Statement presented to this meeting and made a part hereof as though set forth in full herein, is hereby approved and its use by the Underwriter in connection with the public offering and sale of the Series 2022 Bonds with such changes, insertions and omissions as may be approved by the Executive Vice President is hereby approved. The Executive Vice President is hereby authorized and directed to execute the Official Statement and any amendment or supplement thereto, in the name of and on behalf of the Board with such changes therein as shall be approved by the Executive Vice President and to cause the Official Statement and any such amendment or supplement to be delivered to the Underwriter with the approval of any changes, insertions or omissions to be conclusively evidenced by the execution and delivery thereof by the Executive Vice President.

(d) The Purchase Agreement, in substantially the form submitted to this meeting and made a part hereof as though set forth in full herein, is hereby approved. An Authorized Board Representative is hereby authorized and directed to execute and deliver the Purchase Agreement with such changes, insertions and omissions as he or she may approve, said execution being conclusive evidence of such approval.

(e) The Continuing Disclosure Certificate, in substantially the form submitted to this meeting and made a part hereof as though set forth in full herein, is hereby approved. An Authorized Board Representative is hereby authorized and directed to execute and deliver the Continuing Disclosure Certificate with such changes, insertions and omissions as he or she may approve, said execution being conclusive evidence of such approval.

(f) The Escrow Agreement, in substantially the form submitted to this meeting and made a part hereof as though set forth in full herein, is hereby approved. An Authorized Board Representative is hereby authorized and directed to execute and deliver the Escrow Agreement with such changes, insertions and omissions as he or she may approve, said execution being conclusive evidence of such approval.

SECTION 1.06. ***Authorized Officers.*** Except as otherwise specifically set forth herein, each Authorized Board Representative acting singly is hereby authorized and directed to execute and deliver the Board Documents and any and all documents and instruments, and to do and cause to be done any and all acts and things, necessary or proper for carrying out the transactions contemplated by the Board Documents.

ARTICLE II

AUTHORIZATION AND DETAILS OF THE SERIES 2022 BONDS

SECTION 2.01. **Authorization.** Pursuant to the Act, there is hereby authorized the incurring of indebtedness and the issuance of the Board's Series 2022 Bonds to be designated "Board of Supervisors of Louisiana State University and Agricultural and Mechanical College Taxable Auxiliary Revenue Refunding Bonds, Series 2022" in the principal amount of \$_____ to provide funds, together with other available funds of the Board, to (i) refund the Refunded Bonds, and (ii) ~~fund a reserve fund/ pay the premium for a reserve fund surety bond and (iii)~~ pay the costs of issuance of the Series 2022 Bonds~~including the premium for the Insurance Policy~~. Upon the issuance of the Series 2022 Bonds, the proceeds thereof shall be deposited as directed by written order of the Board in the appropriate Fund or Account designated by such order.

SECTION 2.02. **Form; Denominations; Date; Limited Obligations.**

(a) The Series 2022 Bonds shall be fully registered bonds without coupons in denominations of \$5,000 or any integral multiple thereof, and shall be substantially in the form of **Exhibit A** hereto, with such variations as may be permitted or required by the Act or the Bond Resolution. The Series 2022 Bonds may also bear such legends or other text as maybe required by law or usage. The Series 2022 Bonds shall be dated the date of delivery thereof and shall be numbered consecutively from R-1 upward, provided, however, that temporary bonds may be numbered as determined by the Trustee.

(b) The Series 2022 Bonds shall mature on July 1 of each year in such principal amounts and at such rates of interest per annum as follows:

<u>Year (July 1)</u>	<u>Principal Amount</u>	<u>Interest Rate</u>
--------------------------	-----------------------------	--------------------------

%

(c) THE SERIES 2022 BONDS SHALL BE SPECIAL AND LIMITED OBLIGATIONS OF THE BOARD PAYABLE SOLELY FROM AUXILIARY REVENUES, THE LAB SCHOOL REVENUES AND THE RECREATIONAL

SPORTS FEE REVENUES; PROVIDED THAT (i) THE PLEDGE OF THE LAB SCHOOL REVENUES WILL LAPSE ON THE LATER OF (A) JULY 1, [**2034**], AND (B) THE MATURITY DATE OF ANY BONDS ISSUED TO FINANCE OR REFINANCE PROJECTS FOR THE LAB SCHOOL AND (ii) THE PLEDGE OF RECREATIONAL SPORTS FEE REVENUES WILL LAPSE ON THE LATER OF (A) JULY 1, [**2043**], AND (B) THE MATURITY DATE OF ANY BONDS ISSUED TO FINANCE OR REFINANCE PROJECTS FOR THE STUDENT RECREATIONAL SPORTS COMPLEX. THE SERIES 2022 BONDS SHALL NOT CONSTITUTE AN INDEBTEDNESS OR PLEDGE OF THE GENERAL CREDIT OF THE UNIVERSITY, LSU, THE BOARD, THE STATE OR ANY POLITICAL SUBDIVISION THEREOF WITHIN THE MEANING OF ANY CONSTITUTIONAL OR STATUTORY LIMITATION OF INDEBTEDNESS AND SHALL CONTAIN A RECITAL TO THAT EFFECT. NEITHER THE STATE NOR ANY AGENCY OR POLITICAL SUBDIVISION THEREOF, OTHER THAN THE BOARD, SHALL BE OBLIGATED TO PAY THE PRINCIPAL OF THE SERIES 2022 BONDS OR THE INTEREST THEREON, AND THE SERIES 2022 BONDS SHALL NOT BE DEEMED TO CONSTITUTE A DEBT OR LIABILITY OF THE STATE OR ANY AGENCY OR POLITICAL SUBDIVISION OR AGENCY THEREOF, OTHER THAN THE BOARD.

THE AUXILIARY REVENUES, THE LAB SCHOOL REVENUES AND THE RECREATIONAL SPORTS FEE REVENUES ARE PLEDGED TO THE PAYMENT OF THE SERIES 2022 BONDS ON A PARITY WITH THE BOARD'S OUTSTANDING PARITY BONDS AND ANY ADDITIONAL BONDS; PROVIDED THAT (i) THE LAB SCHOOL REVENUES SHALL BE SO PLEDGED ONLY UNTIL THE LATER OF (A) JULY 1, [**2034**], AND (B) THE MATURITY DATE OF ANY BONDS ISSUED TO FINANCE OR REFINANCE PROJECTS FOR THE LAB SCHOOL AND (ii) THE RECREATIONAL SPORTS FEE REVENUES SHALL BE SO PLEDGED ONLY UNTIL THE LATER OF (A) JULY 1, [**2043**], AND (B) THE MATURITY DATE OF ANY BONDS ISSUED TO FINANCE OR REFINANCE PROJECTS FOR THE STUDENT RECREATIONAL SPORTS COMPLEX.

For purposes of this Twentieth Supplemental Resolution, references herein to the term "Auxiliary Revenues" shall be deemed to include Lab School Revenues and Recreational Sports Fee Revenues with the caveat that the pledge of such revenues is limited as set forth in the foregoing paragraphs.

SECTION 2.03. *Payment of Principal and Interest of Series 2022 Bonds; Acceptance of Terms and Conditions.*

(a) Interest Payment Dates for the Series 2022 Bonds shall be January 1 and July 1 of each year, beginning January 1, 2022. Interest shall be computed on the basis of a 360-day year of twelve 30-day months. The Series 2022 Bonds of a given maturity shall bear interest on overdue principal and, to the extent permitted by law, overdue premium and interest at the rate then in effect on the Series 2022 Bonds of such maturity.

(b) Interest on the Series 2022 Bonds shall be computed from the Interest Payment Date to which interest has been paid or duly provided for next preceding the

date of authentication thereof, unless (a) such date of authentication shall be prior to the first Interest Payment Date, in which case interest shall be computed from the date of issuance of the Series 2022 Bonds, or (b) such date of authentication shall be an Interest Payment Date to which interest on the Series 2022 Bonds has been paid in full or duly provided for, in which case interest shall be computed from such date of authentication; provided, however, that if interest on the Series 2022 Bonds shall be in default, Series 2022 Bonds issued in exchange for Series 2022 Bonds surrendered for registration of transfer or exchange shall bear interest from the last date to which interest has been paid or duly provided for on the Series 2022 Bonds or, if no interest has been paid or duly provided for on the Series 2022 Bonds, from the date of delivery thereof.

(c) Principal of any Series 2022 Bonds which have become due and payable, together with any applicable redemption premium, shall be payable only upon presentation and surrender of such Series 2022 Bonds at the principal corporate trust office of the Trustee.

(d) Interest on the Series 2022 Bonds (except defaulted interest) shall be paid to the Persons who are the Owners of the Series 2022 Bonds at the close of business on the Record Date next preceding the Interest Payment Date. Defaulted interest shall be paid as provided in Section 3.06 of the General Bond Resolution. Interest shall be paid by check of the Trustee mailed on the Interest Payment Date to the Owners at their addresses as they appear on the Bond Register or at such other address as is furnished in writing by an Owner to the Trustee prior to the Record Date.

(e) Any Owner of Series 2022 Bonds in an aggregate principal amount of at least \$1,000,000 may, however, elect to have interest payments made to such Owner by wire transfer of Federal Funds. In order to make such election, the Owner must notify the Trustee in writing and provide wire transfer instructions prior to the Record Date for the Interest Payment Date on which such wire transfer payments are to commence. Once an election is made, all subsequent interest payments to such Owner shall be by wire transfer, according to the last wire transfer instructions received prior to the Record Date. The Owner may revoke or change such instructions by delivering a written notice to the Trustee. Such instructions may also provide for the payment of principal and premium by wire transfer of Federal Funds (following presentation and surrender of the Series 2022 Bonds being paid).

(f) Principal of, premium, if any, and interest on the Series 2022 Bonds shall be payable in such coin or currency of the United States of America which is legal tender for payment of public and private debts.

(g) Each payment of principal of, premium, if any, and interest on Series 2022 Bonds shall be accompanied by notice of the CUSIP number of such Series 2022 Bonds.

SECTION 2.04. ***Initial Delivery of Series 2022 Bonds.*** Upon receipt of the following documents, the Trustee shall authenticate the Series 2022 Bonds and deliver them as directed by the Underwriter:

- (a) The executed Series 2022 Bonds;
- (b) A copy, duly certified by the Secretary of the Board, of the General Bond Resolution and this Twentieth Supplemental Resolution;
- (c) A request and authorization to the Trustee signed by an Authorized Board Representative to authenticate and deliver the Series 2022 Bonds as directed by the Underwriter upon payment to the Trustee, but for the account of the Board, of a specified sum;
- (d) An order from an Authorized Board Representative to the Trustee directing the deposits to the Funds and Accounts created herein, the deposits to the Escrow Fund and the payment of 2022 Costs of Issuance;
- (e) The opinion of Breazeale, Sachse & Wilson, L.L.P., Bond Counsel, that the Series 2022 Bonds are legally issued, that the Series 2022 Bonds and the income therefrom are exempt from all taxation in the State of Louisiana or any political subdivision thereof and that interest on the Series 2022 Bonds is included in gross income for federal income tax purposes under existing law;
- (f) The executed Escrow Agreement;
- (g) The executed Continuing Disclosure Certificate;
- [**(h) The Insurance Policy;**] and
- (i) Such other opinions, documents, certificates or agreements as shall be required by Bond Counsel.

SECTION 2.05. *Book-Entry System.*

(a) The Series 2022 Bonds shall be initially issued in the form of a separate single certificated fully registered Series 2022 Bond per maturity. Unless the book-entry system is terminated as provided in this Section 2.05, this Section 2.05 shall override any other conflicting provisions of the Bond Resolution. The Owner of all the Series 2022 Bonds shall be Cede & Co., as nominee for DTC, provided that Cede & Co. may register the transfer of the Series 2022 Bonds to another nominee for DTC if the DTC Representation Letter provides for such transfer. All payments of principal of and premium and interest on the Series 2022 Bonds shall be made in the manner provided in the DTC Representation Letter. The Trustee is hereby authorized and directed to comply with all terms of the DTC Representation Letter.

(b) Neither the Board nor the Trustee shall be liable to any Person, including any Participant and any Person claiming any interest in any Series 2022 Bond under or through DTC or any Participant, for any action or failure to act or delay in action by DTC or any Participant. In particular, neither the Board nor the Trustee shall have any obligation with respect to the accuracy of any records maintained by DTC or any Participant, the payment by DTC or any Participant of any amount in respect of the

principal of or premium or interest on the Series 2022 Bonds, any notice which is permitted or required to be given to Bondholders under this Resolution or which is permitted or required to be given under the DTC Representation Letter, the selection by DTC or any Participant of any Person to receive payment in the event of a partial redemption of the Series 2022 Bonds or any consent given by DTC as Owner.

(c) (i) If DTC gives notice to the Board or the Trustee pursuant to the DTC Representation Letter that it will discontinue providing its services as securities depository with respect to the Series 2022 Bonds, the Board shall, in its sole discretion, either appoint a successor securities depository or terminate the book-entry system for the Series 2022 Bonds. The Board shall give the Trustee written notice of such appointment or termination. If a successor securities depository has not accepted such position prior to the effective date of DTC's termination of its services, the book-entry system shall automatically terminate and may not be reinstated without the consent of all the Owners of the Series 2022 Bonds.

(ii) The Board may also, in its sole discretion, elect to terminate the book-entry system at any time by giving written notice to DTC and the Trustee. Upon termination of the book-entry only system, the Board shall cause the execution of certificated bonds.

Any successor securities depository must be a clearing agency registered with the Securities and Exchange Commission pursuant to Section 17A of the Securities Exchange Act of 1934 and must enter into an agreement with the Board and the Trustee agreeing to act as the depository and clearing agency for all the Series 2022 Bonds. After such agreement has become effective, DTC shall present the Series 2022 Bonds for registration of transfer in accordance with Section 3.05 of the General Bond Resolution and the Trustee shall register them in the name of the successor securities depository or its nominee.

On the effective date of any termination of the book-entry system, the provisions of Section 2.05(a) hereof shall cease to be in effect. After such termination, the Trustee shall, upon presentation of Series 2022 Bonds by DTC or its nominee for registration of transfer or exchange in accordance with Section 3.05 of the General Bond Resolution make such transfer or exchange in accordance with Section 3.05 of the General Bond Resolution.

(d) Upon the appointment of a successor securities depository or termination of the book-entry system, the Trustee shall give notice of such event to the Series 2022 Bond Owners (through DTC) and (i) the name and address of the successor securities depository or (ii) that Series 2022 Bonds may now be obtained by beneficial owners of the Series 2022 Bonds, or their nominees, upon proper instructions being given to DTC by the relevant Participant and compliance by DTC with the provisions of the Resolution regarding registration of transfers.

SECTION 2.06. *Appointment of Trustee and Paying Agent; Removal of the Trustee and Successor Trustee.* (a) The Board hereby appoints The Bank of New York Mellon

Trust Company, N.A., as Trustee and Paying Agent for the Series 2022 Bonds pursuant to Section 11.01 of the General Bond Resolution, which shall be responsible, among other things, for the payment of principal and interest to Series 2022 Bond Owners on the respective Interest Payment Dates and Principal Payment Dates. The Trustee shall designate its principal office to the Board and signify its acceptance of the duties and obligations imposed upon it by this Twentieth Supplemental Resolution by executing and delivering a written instrument of acceptance to the Board.

(b) The Trustee may be removed at any time by an Authorized Board Representative for any breach of its obligations hereunder.

SECTION 2.07. *Disposition of Proceeds of the Series 2022 Bonds and Other Funds of the Board.* Upon the delivery of and payment for the Series 2022 Bonds at the price set forth in the Purchase Agreement, the proceeds thereof, less underwriter's discount and the premium for the Insurance Policy, representing the total sum of \$_____, shall be deposited to the Series 2022 Bond Proceeds Fund and transferred as follows:

(a) The sum of \$_____ shall be deposited to the Series 2022 Cost of Issuance Account therein; and

(b) The sum of \$_____ shall be transferred to the Escrow Trustee of which (i) \$_____ shall be deposited in the Series 2012 Escrow Account, (ii) \$_____ shall be deposited in the Series 2013 Escrow Account, (iii) \$_____ shall be deposited in the Series 2014 Escrow Account and (iv) \$_____ shall be deposited in the Series 2016A Escrow Account.

(c) Pursuant to the written direction of an Authorized Board Representative, the amounts of (i) \$_____ shall be transferred from the Series 2012 Interest Account and the Series 2012 Principal Account of the Bond Fund held under the Fifteenth Supplemental Resolution, and deposited into the Series 2012 Escrow Account, (ii) \$_____ shall be transferred from the Series 2013 Interest Account and Series 2013 Principal Account of the Bond Fund, each held under the Sixteenth Supplemental Indenture, and deposited into the Series 2013 Escrow Account, (iii) \$_____ shall be transferred from the Series 2014 Interest Account and Series 2014 Principal Account of the Bond Fund, each held under the Seventeenth Supplemental Indenture, and deposited into the Series 2014 Escrow Account and (iv) \$_____ shall be transferred from the Series 2016A Interest Account and Series 2016A Principal Account of the Bond Fund, each held under the Eighteenth Supplemental Indenture, and deposited into the Series 2016A Escrow Account.

ARTICLE III

REDEMPTION

SECTION 3.01. ***Extraordinary Optional Redemption of the Series 2022 Bonds.*** The Board may at any time redeem all or any part (in the denomination of \$5,000 or any integral multiple thereof) of the Series 2022 Bonds at a redemption price equal to their principal amount plus accrued interest to the redemption date if a particular Auxiliary Facility financed or refinanced by the Series 2022 Bonds is damaged, destroyed or taken by eminent domain or sold under the threat of condemnation and the Board elects, pursuant to Article VIII of the General Bond Resolution and this Section 3.01 to use the Net Proceeds of casualty insurance or condemnation or sale under threat of condemnation to redeem Series 2022 Bonds rather than repair, replace, rebuild or restore the Auxiliary Facility. Any such redemption must take place within 120 days following the receipt of casualty insurance or condemnation proceeds relating to such damage, destruction or taking.

The Board shall use its reasonable best efforts to repair, replace, rebuild or restore such Auxiliary Facility; however, should it elect to use Net Proceeds to redeem the Series 2022 Bonds, the Board shall give the Trustee at least 35 days' notice of any redemption to be made pursuant to this Section 3.01. The notice shall specify the redemption date and the principal amounts and maturities of Series 2022 Bonds to be redeemed.

SECTION 3.02. ***Optional Redemption.*** Beginning on or after July 1, 20__, the Board may redeem the Series 2022 Bonds maturing on or after July 1, 20__, in whole or in part on any date (if in part, as selected by the Trustee at the direction of the Board) (in denominations of \$5,000 or any integral multiple thereof) at a price equal to the par amount thereof plus accrued interest to the redemption date.

The Board shall give the Trustee at least 35 days' written notice of any redemption to be made pursuant to this Section 3.02. The notice shall specify the redemption date and the principal amounts and maturities of Series 2022 Bonds to be redeemed.

SECTION 3.03. ***[**Mandatory Sinking Fund Redemption.*** The Series 2022 Bonds maturing July 1, 20__ shall be subject to mandatory redemption in the following principal amounts ("*Sinking Fund Amounts*") on the following dates by lot in such manner as shall be determined by the Trustee at a redemption price equal to their principal amount plus accrued interest to the redemption date.

Redemption Date
(July 1)

Principal
Amount

*Final Maturity

However, if Series 2022 Bonds have been redeemed pursuant to the Bond Resolution or if the Board has delivered Series 2022 Bonds to the Trustee for cancellation, the Board may direct that any Sinking Fund Amount be reduced by an amount equal to all or a portion of the principal amount of any Series 2022 Bonds so redeemed or delivered for cancellation (and not previously used to reduce any Sinking Fund Amount). The Board shall deliver any such direction at least 75 days before the redemption date.

If amounts are being held in the Series 2022 Principal Account of the Bond Fund to be used to redeem Series 2022 Bonds pursuant to the Bond Resolution, in lieu of such redemption the Board may, no later than 75 days before the redemption date, direct the Trustee to use part or all of such moneys to purchase such Series 2022 Bonds, in a principal amount not to exceed the next Sinking Fund Amount, which are presented to it by Owners for purchase and which the Board directs the Trustee to purchase. The purchase price of such Series 2022 Bonds shall not exceed the redemption price of the Series 2022 Bonds which would be redeemed but for the operation of this paragraph (accrued interest to be paid from the same Fund or Account from which accrued interest would be paid upon the redemption of such Series 2022 Bonds). Any such purchase shall be completed prior to the time notice would otherwise be required to be given to redeem Series 2022 Bonds. All Series 2022 Bonds so purchased shall be cancelled and applied as a credit (in an amount equal to the principal amount of such Series 2022 Bonds) against the next Sinking Fund Amount.**]

SECTION 3.04. *Notice of Redemption of Series 2022 Bonds.* At least 30 days, but not more than 60 days, before a redemption date pursuant to Sections 3.01 and 3.02 hereof, the Trustee shall mail a notice of redemption to the Owner of each Series 2022 Bond which is to be redeemed. The notice shall be sent by first class, registered or certified mail if the Owner holds \$1,000,000 or more in principal amount of Series 2022 Bonds. The failure of the Trustee to mail notice of redemption to any Owner or any defect in any notice of redemption shall not affect the validity of the redemption of any other Series 2022 Bond.

Each notice of redemption shall state the following with respect to the Series 2022 Bonds being redeemed:

1. the complete name of the Series 2022 Bonds (including Series designation);
2. the redemption date;

3. the redemption price;
4. the date of the notice;
5. the issue date;
6. the interest rate;
7. the maturity date;
8. the CUSIP number;
9. that the Series 2022 Bonds called for redemption must be surrendered to the Trustee to collect the redemption price;
10. the Trustee's name and address;
11. that interest on Series 2022 Bonds called for redemption ceases to accrue on and after the redemption date; and
12. any other items which may be necessary or desirable to comply with regulation or custom.

If less than all the Series 2022 Bonds are to be redeemed, the notice of redemption shall specify the numbers and amounts of the Series 2022 Bonds or portion thereof to be redeemed. The notice of redemption relative to the Series 2022 Bonds shall state that it is conditioned on there being sufficient money on deposit to pay the full redemption price of the Series 2022 Bonds.

Two Business Days prior to mailing notice to other Series 2022 Bondholders, a copy of each notice of redemption shall be sent by the Trustee by certified or registered mail to DTC or its nominee which holds any Series 2022 Bonds, provided that the Trustee may, in its discretion, provide for overnight, telecopied or other form of notice to DTC acceptable to or requested thereby. The Trustee shall file, on the same date notices are mailed to other Bondholders, a copy of each notice of redemption with EMMA.

If a Series 2022 Bond is not presented for payment on or within 30 days after its redemption date, the Trustee shall, as soon as reasonably possible, mail a second notice of redemption to the last Owner of record of such Series 2022 Bond, including the same information as in the first notice. The giving of such notice, or the failure to give such notice or any defect in such notice, shall not affect the validity of the redemption of any Series 2022 Bonds.

SECTION 3.05. *Effect of Redemption.* If notice of redemption has been duly given as aforesaid and money for the payment of the redemption price of the Series 2022 Bonds or portions thereof to be redeemed is held by the Trustee, then on the redemption date designated in such notice the Series 2022 Bonds or portions thereof so called for redemption shall become payable at the redemption price as specified in such notice; and from and after the redemption

date so designated, interest thereon or portions thereof so called for redemption shall cease to accrue, such Series 2022 Bonds or portions thereof shall cease to be entitled to any benefit, protection or security hereunder and the Owners of such Series 2022 Bonds or portions thereof shall have no rights in respect thereof except to receive payment of the redemption price.

ARTICLE IV

PLEDGE OF AUXILIARY REVENUES

SECTION 4.01. *Pledge and Payments.*

(a) (i) All of the Board's right, title and interest to the Auxiliary Revenues are hereby pledged by the Board for the payment of Debt Service Requirements on the Series 2022 Bonds issued hereunder (except as provided in Sections 7.08, 11.02 and Article XIII of the General Bond Resolution). The obligation of the Board to pay Debt Service Requirements on the Series 2022 Bonds from Auxiliary Revenues as provided in this Section shall be on a parity with all other Outstanding Parity Bonds.

(ii) The Board (A) hereby confirms the pledge of, and does hereby pledge, the Lab School Revenues as Auxiliary Revenues as security for the payment of all Bonds Outstanding under the General Bond Resolution and any Supplemental Resolutions until the later of (1) July 1, **[**2034**]**, and (2) the maturity date of any Bonds issued to finance or refinance projects for the Lab School, and (b) hereby additionally confirms the pledge of, and does hereby pledge, the Recreational Sports Fee Revenues as Auxiliary Revenues as security for the payment of all Bonds Outstanding under the General Bond Resolution and any Supplemental Resolutions until the later of (1) July 1, **[**2043**]**, and (2) the maturity date of any Bonds issued to finance or refinance projects for the Student Recreational Sports Complex.

(b) Amounts equal to the aggregate of the amount of principal due on the Series 2022 Bonds on the next Principal Payment Date shall be transferred by the Board from Auxiliary Revenues by check or draft on or prior to the fifth day, or wire transfer on or prior to the third day, immediately preceding each January 1 and July 1, as the case may be, commencing July 1, 2022, with respect to the first Interest Payment Date, and commencing July 1, 2022, with respect to the first Principal Payment Date, to the Series 2022 Principal Account and the Series 2022 Interest Account, as the case may be, held by the Trustee until necessary for the Trustee to transfer funds for payment of the interest or any principal of the Series 2022 Bonds.

(c) To the extent required by Article VII, Section 2.1 of the Constitution of the State of Louisiana of 1974, with respect to fees and civil fines, if any, imposed or increased by the Auxiliary Enterprises, the Board hereby covenants to seek any necessary approval or authorization, legislative or otherwise, of the imposition of such fees or civil fines or increases thereto in order to comply with Section 10.17 of the General Bond Resolution and this Article IV regarding payments from Auxiliary Revenues.

SECTION 4.02. *Rate Covenant.* The Board covenants that it will establish and maintain, so long as any of the Series 2022 Bonds remain Outstanding, such fees, rental, rates and charges for the use of the Auxiliary Facilities as shall be necessary to assure compliance with Section 10.17 of the General Bond Resolution.

ARTICLE V

[**BOND INSURANCE PROVISIONS; ADDITIONAL COVENANTS

SECTION 5.01. ***Insurer Deemed Sole Holder of Series 2022 Bonds for Certain Purposes.*** The Insurer shall be deemed to be the sole Owner of the Insured Bonds for the purpose of exercising any voting right or privilege or giving any consent or direction or taking any other action that the Owners of the Insured Bonds are entitled to take pursuant to the Bond Resolution pertaining to (i) defaults and remedies and (ii) the duties and obligations of the Trustee. In furtherance thereof and as a term of the Bond Resolution and each Insured Bond, each Owner of the Insured Bonds appoints the Insurer as its agent and attorney-in-fact with respect to the Insured Bonds and agrees that the Insurer may at any time during the continuation of any proceeding by or against the Issuer under the United States Bankruptcy Code or any other applicable bankruptcy, insolvency, receivership, rehabilitation or similar law (an "*Insolvency Proceeding*") direct all matters relating to such Insolvency Proceeding, including without limitation, (A) all matters relating to any claim or enforcement proceeding in connection with an Insolvency Proceeding (a "*Claim*"), (B) the direction of any appeal of any order relating to any Claim, (C) the posting of any surety, supersedeas or performance bond pending any such appeal, and (D) the right to vote to accept or reject any plan of adjustment. In addition, each Owner of the Insured Bonds delegates and assigns to the Insurer, to the fullest extent permitted by law, the rights of each Owner of the Insured Bonds in the conduct of any Insolvency Proceeding, including, without limitation, all rights of any party to an adversary proceeding or action with respect to any court order issued in connection with any such Insolvency Proceeding. The Trustee acknowledges such appointment, delegation and assignment by each Owner of the Insured Bonds for the Insurer's benefit, and agrees to cooperate with the Insurer in taking any action reasonably necessary or appropriate in connection with such appointment, delegation and assignment. Remedies granted to the Owners of the Insured Bonds shall expressly include mandamus.

SECTION 5.02. ***Consent of Insurer Required for Acceleration of Maturity.*** The maturity of Insured Bonds shall not be accelerated without the consent of the Insurer and, in the event the maturity of the Insured Bonds is accelerated, the Insurer may elect, in its sole discretion to pay accelerated principal, and interest accrued on such principal, to the date of acceleration (to the extent unpaid by the Board) and the Trustee shall be required to accept such amounts. Upon payment of such accelerated principal and interest accrued to the acceleration date as provided above, the Insurer's obligations under the Insurance Policy with respect to such Insured Bonds shall be fully discharged.

SECTION 5.03. ***Grace Periods for Defaults.*** No grace period for a covenant default shall exceed 30 days or be extended for more than 60 days without the prior written consent of the Insurer. No grace period shall be permitted for payment defaults.

SECTION 5.04. ***Third Party Beneficiary.*** The Insurer is a third party beneficiary of the Bond Resolution.

SECTION 5.05. ***Selection of Bonds for Redemption.*** Upon the occurrence of an extraordinary optional, special or extraordinary mandatory redemption in party, the selection of

Insured Bonds to be redeemed shall be subject to the approval of the Insurer. The exercise of any provision of the Bond Resolution which permits the purchase of Insured Bonds in lieu of redemption shall require the prior written approval of the Insurer if any Insured Bond so purchased is not cancelled upon purchase.

SECTION 5.06. ***Amendments, Supplements, Modifications and Waivers.*** Any amendment, supplement, modification to or waiver of the Bond Resolution or any other transaction document, including any underlying security agreement (each a "*Related Document*"), that requires the consent of Owners of the Insured Bonds or adversely affects the rights and interests of the Insurer shall be subject to the prior written consent of the Insurer. The foregoing notwithstanding, nothing in this Section 5.06 shall be deemed to require the prior written consent of the Insurer to the issuance of Additional Bonds in accordance with the requirements of Section 10.13 of the General Bond Resolution.

SECTION 5.07. ***Exercise of Insurer's Contractual Rights.*** The rights granted to the Insurer under the Bond Resolution or any other Related Document to request consent to or direct any action are rights granted to the Insurer in consideration of its issuance of the Insurance Policy. Any exercise by the Insurer of such rights is merely an exercise of the Insurer's contractual rights and shall not be construed or deemed to be taken for the benefit, or on behalf, of the Owners of the Insured Bonds and such action does not evidence any position of the Insurer, affirmative or negative, as to whether the consent of the Owners of the Insured Bonds or any other person is required in addition to the consent of the Insurer.

SECTION 5.08. ***Defeasance of Insured Bonds.***

(a) Only (i) cash, (ii) non-callable direct obligations of the United States of America ("*Treasuries*"), (iii) evidences of ownership of proportionate interests in future interest and principal payments on Treasuries held by a bank or trust company as custodian, under which the owner of the investment is the real party in interest and has the right to proceed directly and individually against the obligor and the underlying Treasuries are not available to any person claiming through the custodian or to whom the custodian may be obligated, (iv) subject to the prior written consent of the Insurer, pre-refunded municipal obligations rated "AAA and "Aaa" by S&P and Moody's, respectively, or (v) subject to the prior written consent of the Insurer, securities eligible for "AAA" defeasance under then existing criteria of S&P or any combination thereof, shall be used to effect defeasance of the Insured Bonds unless the Insurer otherwise approves.

(b) To accomplish defeasance of the Insured Bonds, the Board shall cause to be delivered (i) a report of an independent firm of nationally recognized certified public accountants or such other accountant as shall be acceptable to the Insurer ("*Accountant*") verifying the sufficiency of the escrow established to pay the Insured Bonds in full on the maturity or redemption date ("*Verification*"), (ii) an escrow deposit agreement (which shall be acceptable in form and substance to the Insurer), (iii) an opinion of nationally recognized bond counsel to the effect that the Insured Bonds are no longer "Outstanding" under the Bond Resolution and (iv) a certificate of discharge of the Trustee with respect to the Insured Bonds; each Verification and defeasance opinion shall be acceptable in

form and substance, and addressed, to the Board, the Trustee and the Insurer. The Insurer shall be provided with final drafts of the above-referenced documentation no less than five Business Days prior to the funding of the escrow.

(c) Insured Bonds shall be deemed "Outstanding" under the Bond Resolution unless and until they are in fact paid and retired or the above criteria are met.

SECTION 5.09. ***Amounts Paid by Insurer.*** Amounts paid by the Insurer under the Insurance Policy shall not be deemed paid for purposes of the Bond Resolution and the Insured Bonds relating to such payments shall remain Outstanding and continue to be due and owing until paid by the Board in accordance with the Bond Resolution. The Bond Resolution shall not be discharged unless all amounts due or to become due to the Insurer have been paid in full or duly provided for.

SECTION 5.10. ***Claims upon the Insurance Policy and Payments by and to the Insurer.*** If, on the third Business Day prior to the related scheduled interest payment or principal payment date ("*Payment Date*") there is not on deposit with the Trustee, after making all transfers and deposits required under the Bond Resolution, moneys sufficient to pay the principal of and interest on the Insured Bonds due on such Payment Date, the Trustee shall give notice to the Insurer and to its designated agent (if any) (the "*Insurer's Fiscal Agent*") by telephone or teletype of the amount of such deficiency by 12:00 noon, New York City time, on such Business Day. If, on the second Business Day prior to the related Payment Date, there continues to be a deficiency in the amount available to pay the principal of and interest on the Insured Bonds due on such Payment Date, the Trustee shall make a claim under the Insurance Policy and give notice to the Insurer and the Insurer's Fiscal Agent (if any) by telephone of the amount of such deficiency, and the allocation of such deficiency between the amount required to pay interest on the Insured Bonds and the amount required to pay principal of the Insured Bonds, confirmed in writing to the Insurer and the Insurer's Fiscal Agent by 12:00 noon, New York City time, on such second Business Day by filling in the form of Notice of Claim and Certificate delivered with the Insurance Policy.

The Trustee shall designate any portion of payment of principal on Insured Bonds paid by the Insurer, whether by virtue of mandatory sinking fund redemption, maturity or other advancement of maturity, on its books as a reduction in the principal amount of Insured Bonds registered to the then current Owner of the Insured Bonds, whether DTC or its nominee or otherwise, and shall issue a replacement Insured Bond to the Insurer, registered in the name of [****bond insurer****], in a principal amount equal to the amount of principal so paid (without regard to Authorized Denominations); provided that the Trustee's failure to so designate any payment or issue any replacement Insured Bond shall have no effect on the amount of principal or interest payable by the Board on any Insured Bond or the subrogation rights of the Insurer.

The Trustee shall keep a complete and accurate record of all funds deposited by the Insurer into the Policy Payments Account (defined below) and the allocation of such funds to payment of interest on and principal of any Insured Bond. The Insurer shall have the right to inspect such records at reasonable times upon reasonable notice to the Trustee.

Upon payment of a claim under the Insurance Policy, the Trustee shall establish a separate special purpose trust account for the benefit of the Owners of the Insured Bonds referred to herein as the "Policy Payments Account" and over which the Trustee shall have exclusive control and sole right of withdrawal. The Trustee shall receive any amount paid under the Insurance Policy in trust on behalf of Owners of the Insured Bonds and shall deposit any such amount in the Policy Payments Account and distribute such amount only for purposes of making the payments for which a claim was made. Such amounts shall be disbursed by the Trustee to Owners of the Insured Bonds in the same manner as principal and interest payments are to be made with respect to the Insured Bonds under the sections of the Bond Resolution regarding payment of Insured Bonds. It shall not be necessary for such payments to be made by checks or wire transfers separate from the check or wire transfer used to pay debt service with other funds available to make such payments. Notwithstanding anything in the Bond Resolution to the contrary, the Board agrees to pay to the Insurer from the Auxiliary Revenues (a) a sum equal to the total of all amounts paid by the Insurer under the Insurance Policy (the "*Insurer Advances*"); and (b) interest on such Insurer Advances from the date paid by the Insurer until payment thereof in full, payable to the Insurer at the Late Payment Rate per annum (collectively, the "*Insurer Reimbursement Amount*"). "Late Payment Rate" means the lesser of (a) the greater of (i) the per annum rate of interest, publicly announced from time to time by JPMorgan Chase Bank at its principal office in the City of New York, as its prime or base lending rate (any change in such rate of interest to be effective on the date such change is announced by JPMorgan Chase Bank) plus 3%, and (ii) the then applicable highest rate of interest on the Insured Bonds and (b) the maximum rate permissible under applicable usury or similar laws limiting interest rates. The Late Payment Rate shall be computed on the basis of the actual number of days elapsed over a year of 360 days. The Board hereby covenants and agrees that the Insurer Reimbursement Amounts are secured by a lien on and pledge of the Auxiliary Revenues and payable from such Auxiliary Revenues on a parity with debt service due on the Series 2022 Bonds.

Funds held in the Policy Payments Account shall not be invested by the Trustee and may not be applied to satisfy any costs, expenses or liabilities of the Trustee. Any funds remaining in the Policy Payments Account following a Payment Date shall be promptly remitted to the Insurer.

SECTION 5.11. ***Rights of Subrogation.*** The Insurer shall, to the extent it makes any payment of principal or interest on the Insured Bonds, become subrogated to the rights of the recipients of such payments in accordance with the terms of the Insurance Policy (which subrogation rights shall also include the rights of any such recipients in connection with any Insolvency Proceeding). Each obligation of the Board to the Insurer under the Related Documents shall survive discharge or termination of such Related Documents.

SECTION 5.12. ***Payment or Reimbursement of Insurer.*** The Board shall pay or reimburse the Insurer from the Auxiliary Revenues any and all charges, fees, costs and expenses that the Insurer may reasonably pay or incur in connection with (a) the administration, enforcement, defense or preservation of any rights or security in any Related Document; (b) the pursuit of any remedies under the Bond Resolution or any other Related Document or otherwise afforded by law or equity, (c) any amendment, waiver or other action with respect to, or related to, the Bond Resolution or any other Related Document, whether or not executed or completed, or (d) any litigation or other dispute in connection with the Bond Resolution or any other Related

Document or the transactions contemplated thereby, other than costs resulting from the failure of the Insurer to honor its obligations under the Insurance Policy. The Insurer reserves the right to charge a reasonable fee as a condition to executing any amendment, waiver or consent proposed in respect to the Bond Resolution or any other Related Document.

SECTION 5.13. ***Insurer Entitled to Pay Principal or Interest on the Insured Bonds.*** The Insurer shall be entitled to pay principal or interest on the Insured Bonds that shall become Due for Payment but shall be unpaid by reason of Nonpayment by the Issuer (as such terms are defined in the Insurance Policy) and any amounts due on the Insured Bonds as a result of acceleration of the maturity thereof, whether or not the Insurer has received a Notice of Nonpayment (as such terms are defined in the Insurance Policy) or a claim upon the Insurance Policy.

SECTION 5.14. ***Insurer Notice Address.*** The notice address of the Insurer is:

[to come]

In each case in which notice or other communication refers to an Event of Default, then a copy of such notice or other communication shall also be sent to the attention of the General Counsel and shall be marked to indicate "URGENT MATERIAL ENCLOSED."

SECTION 5.15. ***Information Requirements.*** The Insurer shall be provided with the following information by the Board or the Trustee, as the case may be:

- (a) to the extent not otherwise filed with EMMA, annual audited financial statements relating to the immediately preceding fiscal year by no later than April 30 of each year (together with a certification of the Board that it is not aware of any default of Event of Default under the Bond Resolution), and, upon request, the Board's annual budget within 30 days after the approval thereof, together with such other information, data or reports as the Insurer shall reasonably request from time to time;
- (b) notice of any default known to the Trustee or the Board within five Business Days after knowledge thereof;
- (c) prior notice of the advance refunding or redemption of any of the Insured Bonds, including the principal amount, maturities and CUSIP numbers thereof;
- (d) notice of the resignation or removal of the Trustee and Bond Registrar and the appointment of, and acceptance of duties by, any successor thereto;
- (e) notice of the commencement of any Insolvency Proceeding;
- (f) notice of the making of any claim in connection with any Insolvency Proceeding seeking the avoidance as a preferential transfer of any payment of principal of, or interest on, the Insured Bonds;
- (g) the full original transcript of all proceedings relating to the execution of any amendment, supplement or waiver to the Related Documents;

(h) all reports, notices and correspondence to be delivered to Owners of the Insured Bonds under the terms of the Related Documents;

(i) all other information furnished pursuant to the Continuing Disclosure Certificate shall also be provided to the Insurer, simultaneously with the furnishing of such information; and

(j) such additional information as the Insurer may reasonably request.

SECTION 5.16. ***Access to Key Personnel, Facilities and Records.*** The Board will permit the Insurer to discuss the affairs, finances and accounts of the Board or any information the Insurer may reasonably request regarding the security for the Series 2022 Bonds with the appropriate officers of the Board and will use commercially reasonable efforts to enable the Insurer to have access to the facilities, books and records of the Board on any Business Day during normal business hours upon reasonable prior notice.

SECTION 5.17. ***Determinations of Adverse Effects on the Insurance Policy.*** In determining whether any amendment, consent, waiver or other action to be taken, or any failure to take action, under the Bond Resolution would adversely affect the security for the Series 2022 Bonds or the rights of the Owners, any such amendment, consent, waiver, action or inaction shall be considered as if there were no Insurance Policy.

SECTION 5.18. ***No Impairment of Security.*** Subject to the provisions of Section 5.06 hereof, no contract shall be entered into or any action taken by which the rights of the Insurer or security for or sources of payment of the Series 2022 Bonds may be impaired or prejudiced in any material respect except upon obtaining the prior written consent of the Insurer.

SECTION 5.19. ***Loss by the Insurer of Certain Rights.***

(a) All provisions herein regarding rights, consents, approvals, directions or requests by the Insurer shall be deemed to not require or permit such rights, consents, approvals, directions or requests by the Insurer and shall be read as if the Insurer were not mentioned therein, during any time in which: (i) the Insurer is in default in its obligation to make payments under the Insurance Policy when due; (ii) the Insurance Policy shall at any time for any reason cease to be valid and binding on the Insurer, or shall be declared to be null and void, in each case by a final, non-appealable order of a court of competent jurisdiction, or the validity or enforceability of any provision thereof is being contested by the Insurer or any governmental agency or authority acting as a receiver or similar capacity for the Insurer, or if the Insurer is denying further liability or obligation under the Insurance Policy; (iii) a proceeding has been instituted in a court having jurisdiction in the premises seeking an order for relief, rehabilitation, reorganization, conservation, liquidation or dissolution in respect of the Insurer under Article 16 of the Insurance Law of the State of New York or any successor provision thereto or similar provision of law and such proceeding is not terminated for a period of 90 consecutive days or such court enters an order granting the relief sought in such proceeding; or (iv) the Insured Bonds are no longer Outstanding and any amounts due or to become due to the Insurer have been paid in full; provided that, to the extent that the Insurer has made any payment of

principal of or interest on the Insured Bonds under the Insurance Policy, it shall retain its rights of subrogation and reimbursement under this Twentieth Supplemental Resolution.

(b) Subject to subsection (a) hereof, the covenants of the Board in this Article V are solely for the benefit of the Insurer and can be modified or waived in whole or in part by the Insurer or as otherwise agreed to between the Board and the Insurer without the consent of the Trustee and the Owners of the Insured Bonds.

(c) In the case of any inconsistency between the provisions of this Article V and any other provisions of this Twentieth Supplemental Resolution or the General Bond Resolution, the provisions of this Article V shall govern.**]

ARTICLE VI

FUNDS AND ACCOUNTS

SECTION 6.01. ***Creation of Funds and Accounts.*** There are hereby created the following special trust Funds and Accounts to be held by the Trustee:

(a) Louisiana State University and Agricultural and Mechanical College Auxiliary Revenue Refunding Bonds, Series 2022 Bond Proceeds Fund (the "Series 2022 Bond Proceeds Fund");

(b) Series 2022 Costs of Issuance Account, to be held within the Series 2022 Bond Proceeds Fund;

(c) Series 2022 Principal Account, and Series 2022 Interest Account.

All moneys and investments deposited with a Trustee in the Funds and Accounts shall be held in trust and applied only in accordance with the Bond Resolution, particularly Article VII of the General Bond Resolution and this Article VI, and shall be trust funds for the purpose of the Bond Resolution. All proceeds of the Series 2022 Bonds shall be initially deposited to the Series 2022 Bond Proceeds Fund and transferred as provided in Section 2.07 of this Twentieth Supplemental Resolution.

SECTION 6.02. ***Series 2022 Bond Proceeds Fund.*** The Series 2022 Bond Proceeds Fund shall be maintained with the Trustee and used to receive the proceeds of the Series 2022 Bonds; all to be transferred to the various Funds and Accounts or paid in the amounts specified in Section 2.07 hereof and as shall be specified in the request and authorization delivered pursuant to Section 2.04 hereof.

SECTION 6.03. ***Intentionally Left Blank.***

SECTION 6.04. ***Series 2022 Costs of Issuance Account of the Series 2022 Bond Proceeds Fund.*** Moneys in the Series 2022 Costs of Issuance Account shall be applied by the Trustee to pay, upon the written order dated the date of delivery of the Bonds by an Authorized Board Representative or otherwise upon the receipt of a Requisition (2022 Costs of Issuance), amounts of expenses certified in such request which are fees and expenses incurred or to be incurred in connection with or incident to the issuance and sale of the Series 2022 Bonds. Upon the earlier of (i) one hundred eighty (180) days following the date of issuance of the Series 2022 Bonds or (ii) receipt of the written direction of an Authorized Board Representative stating that all the Series 2022 Costs of Issuance have been paid, the Trustee shall transfer any amounts remaining in the Series 2022 Costs of Issuance Account, including the earnings thereon, to the Series 2022 Interest Account and the Series 2022 Principal Account, as applicable.

SECTION 6.05. ***Series 2022 Interest Account and Series 2022 Principal Account.***
(a) There shall be deposited into the Series 2022 Interest Account or the Series 2022 Principal Account, as appropriate, and as and when received (i) all payments pursuant to Section 4.01 hereof and any payments on the Series 2022 Bonds, (ii) all moneys transferred to the Series 2022 Interest Account or Series 2022 Principal Account from the Series 2022 Costs of Issuance

Account pursuant to Section 6.04 hereof, (iii) all other moneys required or permitted to be deposited into the Series 2022 Interest Account or Series 2022 Principal Account pursuant to this Twentieth Supplemental Resolution, including any supplements or amendments hereto and (iv) all other moneys received by the Trustee when accompanied by directions not inconsistent with this Twentieth Supplemental Resolution that such moneys are to be paid into the Series 2022 Principal Account or Series 2022 Interest Account. There shall also be retained in the Series 2022 Principal Account and Series 2022 Interest Account, respectively, interest and other income received on investment of moneys in the Series 2022 Principal Account and Series 2022 Interest Account to the extent provided in Section 6.06 hereof. If the Trustee does not receive payments into the Series 2022 Principal Account and the Series 2022 Interest Account pursuant to Section 4.01 hereof when due, the Trustee will immediately notify the Board of such nonpayment. The Board shall receive a credit against the Board's obligation to make deposits in the Series 2022 Principal Account and Series 2022 Interest Account to the extent of interest earnings on moneys in the Series 2022 Principal Account or Series 2022 Interest Account.

SECTION 6.06. *Investments and Earnings on Certain Funds and Accounts and Valuation Thereof.* The amounts on deposit in the Funds and Accounts created hereunder shall be invested by the Trustee in Permitted Investments (as defined in Section 1.01 of this Twentieth Supplemental Resolution) in accordance with the written directions signed by an Authorized Board Representative. Notwithstanding any provision of the General Bond Resolution to the contrary, earnings on the amounts held in the Series 2022 Interest Account or Series 2022 Principal Account of the Bond Fund shall be retained therein.

Any provisions of Article IX of the General Bond Resolution to the contrary notwithstanding, for the purpose of determining the amount in any Fund or Account, all Permitted Investments credited to such Fund or Account shall be valued at fair market value. Except as otherwise provided in this paragraph, the Trustee shall determine the fair market value based on accepted industry standards and from accepted industry providers selected by the Trustee. Certificates of deposit shall be valued at the face amount thereof plus accrued interest. Other investments not specified in this paragraph shall be valued in accordance with the value established by prior agreement between the Board and the Trustee.

ARTICLE VII

MISCELLANEOUS

SECTION 7.01. ***Twentieth Supplemental Resolution to Constitute Contract.*** In consideration of the purchase and the acceptance of the Series 2022 Bonds by those who shall hold the same from time to time, the provisions of the General Bond Resolution and this Twentieth Supplemental Resolution shall be a part of the contract of the Board with the Owners of the Series 2022 Bonds and shall be deemed to be and shall constitute a contract between the Board, the Trustee and the Owners from time to time of the Series 2022 Bonds. The provisions, covenants and agreements herein set forth to be performed by and on behalf of the Board shall be for the benefit, protection and security of the holders of any and all of the Series 2022 Bonds.

SECTION 7.02. ***Conflicts with General Bond Resolution.*** To the extent any provisions contained in this Twentieth Supplemental Resolution conflict with any provisions contained in the General Bond Resolution, the provisions of this Twentieth Supplemental Resolution shall govern.

SECTION 7.03. ***Notices.*** Any notice that is required to be given hereunder or under the General Bond Resolution, as the case may be, shall be deemed to be given, unless otherwise specified herein, upon delivery or mail by first class, registered or certified mail, postage prepaid, or sent electronically or sent by telegram, telecopy or telex, addressed to the parties as follows:

- Board:
- (1) President
Louisiana State University
3810 West Lakeshore Drive, Suite 111
Baton Rouge, LA 70808
 - (2) Executive Vice President for Finance and Administration/CFO
Louisiana State University
330 Thomas Boyd Hall
Baton Rouge, LA 70803

Trustee and
Paying Agent:

The Bank of New York Mellon Trust Company, N.A.
Corporate Trust
[**10161 Centurion Parkway
Jacksonville, Florida 32256
Attention: Stephanie Matthews, Vice President
Facsimile: (904) 645-1921**]

DTC:

Notices required to be given under this Resolution to DTC by facsimile transmission shall be sent to DTC's Call Notification Department at (516) 227-4039 or (516) 227-4190. Notices to DTC by mail or any other means shall be sent to:

Depository Trust Company
711 Stewart Avenue

Garden City, New York 11530
Attention: Call Notification Department
Muni Reorganization Manager

SECTION 7.04. **Notices to Moody's and Fitch.** Any notice that is required to be given hereunder or under the General Bond Resolution, as the case may be, to Moody's or Fitch shall be deemed to be given, unless otherwise specified herein, upon delivery or mail by first class, registered or certified mail, postage prepaid, or sent by telegram, telecopy or telex, addressed to the parties as follows:

Moody's: Moody's Investors Service
525077 Center Drive, Suite 150
Charlotte, North Carolina 28217
Telecopy: (704) 559-6950
Attention: Called Bond Department

Fitch: Fitch Ratings
One State Street Plaza New York, NY 10004
Email: pubfinsurv@fitchratings.com
Telecopy: (212) 480-4421

S&P: S&P Global Ratings
55 Water Street
New York, New York 10041
Telecopy: (212) ___-____

SECTION 7.05. **Continuing Disclosure.** The Board hereby covenants to enter into the Continuing Disclosure Certificate in connection with the Series 2022 Bonds, which shall constitute the written undertaking (the "*Undertaking*") for the benefit of the holders of the Series 2022 Bonds required by Section (b)(5) of Securities and Exchange Commission Rule 15c2-12 under the Securities Exchange Act of 1934, as amended (17 CFR Part 240, § 240.15c2-12) (the "*Rule*"). It is the Board's express intention that this Section 7.05 and the Undertaking be for the benefit of the holders of the Series 2022 Bonds and each Bondholder be a beneficiary of this Section 7.05 with the right to enforce this Section 7.05 and the Undertaking directly against the Board.

SECTION 7.06. **Parties Interested Herein.** Nothing in the Bond Resolution expressed or implied is intended or shall be construed to confer upon, or to give or grant to, any person or entity, other than the Board, the Trustee[**, the Insurer**] and the registered owners of the Series 2022 Bonds, any rights, remedy or claim under or by reason of the Bond Resolution or any covenant, condition or stipulation hereof, and all covenants, stipulations, promises and agreements in the Bond Resolution contained by and on behalf of the Board shall be for the sole and exclusive benefit of the Board, the Trustee[**, the Insurer**] and the registered owners of the Series 2022 Bonds.

SECTION 7.07. **Effective Date.** This Twentieth Supplemental Resolution shall be effective on _____, 2022.

SECTION 7.08. ***Disqualified Series 2022 Bonds.*** Series 2022 Bonds held for the account of the Board shall not be deemed Outstanding for the purpose of any consent or other action or any calculation of Outstanding Bonds provided in the Bond Resolution, and shall not be entitled to consent to or take any other action provided in the Bond Resolution (provided, however, that only Series 2022 Bonds that the Trustee knows to be so held shall be disregarded), and the Trustee may adopt appropriate regulations to require each Owner, before such Owner's consent provided for in Section 12.03 of the General Bond Resolution shall be deemed effective, to reveal if the Series 2022 Bonds as to which such consent is given are disqualified as provided in this Section 7.08.

SECTION 7.09. ***Electronic Transmissions.*** The Trustee shall have the right to accept and act upon directions and instructions, including funds transfer instructions (collectively, "Directions") given pursuant to this Twentieth Supplemental Resolution or any other document reasonably relating to the Series 2022 Bonds and delivered using Electronic Means; provided, however, that the Board shall provide to the Trustee an incumbency certificate listing each Authorized Board Representative with the authority to provide such Directions and containing specimen signatures of such Authorized Board Representative, which incumbency certificate shall be amended by the Board whenever a person is to be added or deleted from the listing. If the Board elects to give the Trustee Directions using Electronic Means and the Trustee in its discretion elects to act upon such Directions, the Trustee's understanding of such Directions shall be deemed controlling. The Board understands and agrees that the Trustee cannot determine the identity of the actual sender of such Directions and that the Trustee shall conclusively presume that directions that purport to have been sent by an Authorized Board Representative listed on the incumbency certificate provided to the Trustee have been sent by such Authorized Board Representative. The Board shall be responsible for ensuring that only Authorized Board Representatives transmit such Directions to the Trustee and that all Authorized Board Representatives are solely responsible to safeguard the use and confidentiality of applicable user and authorization codes, passwords and/or authentication keys. The Trustee shall not be liable for any losses, costs or expenses arising directly or indirectly from the Trustee's reliance upon and compliance with such Directions notwithstanding such directions conflict or are inconsistent with a subsequent written Direction. The Board agrees, to the extent permitted by applicable law: (i) to assume all risks arising out of the use of Electronic Means to submit Directions to the Trustee, including without limitation the risk of the Trustee acting on unauthorized Directions, and the risk of interception and misuse by third parties, as long as the Directions purport to come from an Authorized Board Representative and have an electronic copy of a manual signature or an electronic signature of the Authorized Board Representative; (ii) that it is fully informed of the protections and risks associated with the various methods of transmitting Directions to the Trustee and that there may be more secure methods of transmitting Directions than the method(s) selected by the Board; (iii) that the security procedures (if any) to be followed in connection with its transmission of Directions provide to it a commercially reasonable degree of protection in light of its particular needs and circumstances; and (iv) to notify the Trustee immediately upon learning of any compromise or unauthorized use of the security procedures.

[Signature Page to Twentieth Supplemental Resolution]

The foregoing Twentieth Supplemental Resolution was offered by _____ and seconded by _____ and thereupon a vote was taken on the approval of this Twentieth Supplemental Resolution, and the vote thereon was unanimous.

(Other items not pertinent hereto are omitted)

**BOARD OF SUPERVISORS OF LOUISIANA
STATE UNIVERSITY AND AGRICULTURAL
AND MECHANICAL COLLEGE**

By _____
Name: Remy Voisin Starns
Title: Chair

ATTEST:

By: _____
Name: William F. Tate IV
Title: Secretary

STATE OF LOUISIANA

PARISH OF EAST BATON ROUGE

I, the undersigned Administrative Secretary to the Board of Supervisors of Louisiana State University and Agricultural and Mechanical College (the "*Board*"), do hereby certify that the foregoing constitutes a true and correct copy of a resolution approved by the Board on October 29, 2021, and executed on _____, 2022, providing for the issuance of _____ and No/100 (\$_____) principal amount of Board of Supervisors of Louisiana State University and Agricultural and Mechanical College Taxable Auxiliary Revenue Refunding Bonds, Series 2022 pursuant and supplemental to said General Bond Resolution; approving and confirming the sale of such bonds; prescribing the form, fixing the details and providing for the payment of principal of and interest on such bonds and the application of the proceeds thereof; and providing for other matters in connection therewith, which resolution was duly adopted by the Board at a meeting duly called, noticed and held and at which meeting a quorum was present and voting.

I further certify that said Resolution has not been amended or rescinded and is in full force and effect.

IN FAITH WHEREOF, witness my official signature and the impress of the official seal of said Board to be effective on the _____ day of _____, 2022.

Nicole Griffith, Administrative Secretary

[SEAL]

FORM OF SERIES 2022 BONDS

Unless this Series 2022 Bond is presented by an authorized representative of the Depository Trust Company, a New York corporation ("*DTC*"), to the Board or its agent for registration of transfer, exchange, or payment, and any Series 2022 Bond is registered in the name of Cede & Co. or in such other name as is requested by an authorized representative of DTC (and any payment is made to Cede & Co. or to such other entity as is requested by an authorized representative of DTC), ANY TRANSFER, PLEDGE, OR OTHER USE HEREOF FOR VALUE OR OTHERWISE BY OR TO ANY PERSON IS WRONGFUL inasmuch as the registered owner hereof, Cede & Co., has an interest herein.

UNITED STATES OF AMERICA

STATE OF LOUISIANA

**BOARD OF SUPERVISORS
OF LOUISIANA STATE UNIVERSITY
AND AGRICULTURAL AND MECHANICAL COLLEGE
TAXABLE AUXILIARY REVENUE REFUNDING BONDS
SERIES 2022**

No. R—____ \$_____

<u>INTEREST RATE</u>	<u>MATURITY DATE</u>	<u>DATED</u>	<u>CUSIP #</u>
_____ %	July 1, _____	_____, 2022	_____

REGISTERED OWNER: CEDE & CO.

PRINCIPAL AMOUNT: _____ DOLLARS

KNOW ALL PERSONS BY THESE PRESENTS that the Board of Supervisors of Louisiana State University and Agricultural and Mechanical College (the "*Board*"), being a constitutional corporation under the laws of the State of Louisiana (the "*State*"), for value received, hereby promises to pay to the Bond Owner specified above or registered assigns solely from the special funds provided therefor, the Principal Amount specified above, on the Maturity Date specified above (unless called for earlier redemption), and to pay from such special funds interest thereon on January 1 and July 1 of each year ("*Interest Payment Date*") commencing January 1, 2022, at the Interest Rate per annum specified above, until the Principal Amount specified above is paid or duly provided for. Interest on the Series 2022 Bonds shall be computed from the Interest Payment Date to which interest has been paid or duly provided for next preceding the date of authentication thereof, unless (a) such date of authentication shall be prior to the first Interest Payment Date, in which case interest shall be computed from the date of issuance of the Series 2022 Bonds, or (b) such date of authentication shall be an Interest Payment

Date to which interest on the Series 2022 Bonds has been paid in full or duly provided for, in which case interest shall be computed from such date of authentication; provided, however, that if interest on the Series 2022 Bonds shall be in default, Series 2022 Bonds issued in exchange for Series 2022 Bonds surrendered for registration of transfer or exchange shall bear interest from the last date to which interest has been paid or duly provided for on the Series 2022 Bonds or, if no interest has been paid or duly provided for on the Series 2022 Bonds, from the date of delivery thereof.

The principal of and premium, if any, on this Series 2022 Bond is payable upon presentation and surrender hereof at the principal corporate trust office of The Bank of New York Mellon Trust Company, N.A., [**Jacksonville, Florida,**] as trustee and paying agent (the "Trustee"). Interest on this Series 2022 Bond will be paid on each Interest Payment Date (or, if such Interest Payment Date is not a Business Day, on the next succeeding Business Day), by check mailed by the Trustee to the person in whose name this Series 2022 Bond is registered (the "Bond Owner") in the registration records of the Board maintained by the Trustee and at the address appearing thereon at the close of business on the fifteenth (15th) day (whether or not a Business Day) of the calendar month next preceding such Interest Payment Date (the "Record Date"); provided that any Bond Owner of an aggregate principal amount of at least \$1,000,000 of the Series 2022 Bonds may elect to have interest payments made by wire transfer of Federal Funds. Any such interest which is payable, but is not punctually paid or duly provided for, on any Interest Payment Date ("Defaulted Interest") shall forthwith cease to be payable to the person who is the Bond Owner hereof on the relevant Record Date by virtue of being such owner; and such Defaulted Interest shall be paid by the Board to the persons in whose names the Series 2022 Bonds (or their respective predecessor Series 2022 Bonds) are registered at the close of business on a Special Record Date for the payment of such Defaulted Interest, set by the Trustee as described in the General Bond Resolution adopted by the Board on June 17, 1994, as supplemented and amended, and the Twentieth Supplemental Resolution approved by the Board on October 29, 2021, and executed by a duly authorized representative of the Board on _____, 2022, authorizing the issuance of this Series 2022 Bond (collectively, the "Bond Resolution"), for the payment of any Defaulted Interest. Such Special Record Date shall be fixed by the Trustee whenever moneys become available for payment of the defaulted interest, and notice of the Special Record Date shall be given to the Bond Owners of the series of which this is one (the "Series 2022 Bonds") not less than ten (10) days prior to such Special Record Date.

The Series 2022 Bonds are issuable as fully registered bonds without coupons in denominations of \$5,000 and any integral multiple thereof and are exchangeable for fully registered Series 2022 Bonds of the same maturity in equal aggregate principal amounts and in authorized denominations at the aforesaid office of the Trustee, but only in the manner, subject to the limitations, and on payment of the charges provided in the Bond Resolution.

All terms defined in the Bond Resolution and not otherwise defined in this Series 2022 Bond shall have the meaning given to those terms in the Bond Resolution.

Extraordinary Optional Redemption. The Board may at any time redeem all or any part (in the denomination of \$5,000 or any integral multiple thereof) of the Series 2022 Bonds at a redemption price equal to their principal amount plus accrued interest to the redemption date if a

particular Auxiliary Facility is damaged, destroyed or taken by eminent domain or sold under the threat of condemnation and the Board elects to use the net proceeds of casualty insurance or condemnation or sale under threat of condemnation to redeem Series 2022 Bonds rather than repair, replace, rebuild or restore the Auxiliary Facility. Any such redemption must take place within 120 days following the receipt of casualty insurance or condemnation proceeds relating to such damage, destruction or taking.

The Board shall give the Trustee at least 35 days' notice of any such redemption to be made. The notice shall specify the redemption date and the principal amounts and maturities of Series 2022 Bonds to be redeemed.

Optional Redemption. Beginning on or after July 1, 20__, the Board may redeem the Series 2022 Bonds maturing on or after July 1, 20__, in whole (or if in part, on any date or in part as selected by the Trustee at the direction of the Board) (in denominations of \$5,000 or any integral multiple thereof) at a price equal to the par amount thereof plus accrued interest to the redemption date.

The Board shall give the Trustee at least 35 days' written notice of any such redemption to be made. The notice shall specify the redemption date and the principal amounts and maturities of Series 2022 Bonds to be redeemed.

[Mandatory Sinking Fund Redemption.** The Series 2022 Bonds maturing July 1, 2040 shall be subject to mandatory redemption in the following principal amounts ("*Sinking Fund Amounts*") on the following dates by lot in such manner as shall be determined by the Trustee at a redemption price equal to their principal amount plus accrued interest to the redemption date.

Redemption Date (July 1)	Principal Amount
-------------------------------------	-----------------------------

*Final Maturity**]

Notice of Redemption of Series 2022 Bonds. At least 30 days, but not more than 60 days, before a redemption date (other than for mandatory sinking fund redemption), the Trustee shall mail a notice of redemption to the Owner of each Series 2022 Bond which is to be redeemed. The notice shall be sent by first class, registered or certified mail if the Owner holds \$1,000,000 or more in principal amount of Series 2022 Bonds. The failure of the Trustee to mail notice of redemption to any Owner or any defect in any notice of redemption shall not affect the validity of the redemption of any other Series 2022 Bond. Each notice of redemption shall state the following with respect to the Series 2022 Bonds being redeemed: the complete name of the Series 2022 Bonds (including Series designation); the redemption date; the redemption price; the

date of the notice; the issue date; the interest rate; the maturity date; the CUSIP number; that the Series 2022 Bonds called for redemption must be surrendered to the Trustee to collect the redemption price; the Trustee's name and address; that interest on Series 2022 Bonds called for redemption ceases to accrue on and after the redemption date; and any other items which may be necessary or desirable to comply with regulation or custom.

If less than all the Series 2022 Bonds are to be redeemed, the notice of redemption shall specify the numbers and amounts of the Series 2022 Bonds or portion thereof to be redeemed. The notice of redemption relative to the Series 2022 Bonds shall state that it is conditioned on there being sufficient money on deposit to pay the full redemption price of the Series 2022 Bonds.

If a Series 2022 Bond is not presented for payment on or within 30 days after its redemption date, the Trustee shall, as soon as reasonably possible, mail a second notice of redemption to the last Owner of record of such Series 2022 Bond, including the same information as in the first notice. The giving of such notice, or the failure to give such notice or any defect in such notice, shall not affect the validity of the redemption of any Series 2022 Bonds.

Effect of Redemption. If notice of redemption has been duly given as aforesaid and money for the payment of the redemption price of the Series 2022 Bonds or portions thereof to be redeemed is held by the Trustee, then on the redemption date designated in such notice the Series 2022 Bonds or portions thereof so called for redemption shall become payable at the redemption price as specified in such notice; and from and after the redemption date so designated, interest thereon or portions thereof so called for redemption shall cease to accrue, such Series 2022 Bonds or portions thereof shall cease to be entitled to any benefit, protection or security hereunder and the Owners of such Series 2022 Bonds or portions thereof shall have no rights in respect thereof except to receive payment of the redemption price.

Exchange and Transfer of Series 2022 Bonds. The Board and the Trustee shall not be required to issue, register the transfer of or exchange (a) any Series 2022 Bonds during a period beginning at the opening of business on the Regular Record Date and ending at the close of business on the Interest Payment Date or (b) any Series 2022 Bond called for redemption prior to maturity during a period beginning on the opening of business fifteen (15) days before the date of the mailing of notice of redemption of such Series 2022 Bonds and ending on the date of such redemption.

Upon surrender for registration of transfer of any Series 2022 Bond, the Trustee shall register and deliver in the name of the transferee or transferees one or more new fully registered Series 2022 Bonds of authorized denomination and maturity and like aggregate principal amount. At the option of a Bond Owner, Series 2022 Bonds may be exchanged for other Series 2022 Bonds of authorized denominations of the same Series and maturity and like aggregate principal upon surrender at such office. Whenever any Series 2022 Bonds are so surrendered for exchange, the Trustee shall register and deliver in exchange thereof the Series 2022 Bond or Series 2022 Bonds which the Bond Owner making the exchange shall be entitled to receive after receipt of the Series 2022 Bonds to be transferred in proper form. All Series 2022 Bonds presented for registration of transfer or exchange shall (if so required by the Board or the

Trustee), be accompanied by a written instrument or instruments of transfer in form and with a guaranty of signature satisfactory to Trustee, duly executed by the Bond Owner or by such Bond Owner's duly authorized attorney. No charge shall be made to the Bond Owner for any exchange or transfer of Series 2022 Bonds, but the Trustee may require payment of a sum sufficient to cover any tax, fee or other governmental charge that may be imposed in relation thereto.

The Series 2022 Bonds shall be valid obligations of the Board, evidencing the same debt and entitled to the same benefits under the Bond Resolution as the Series 2022 Bonds surrendered upon authentication thereof by the Trustee. Prior to due presentment for registration of transfer of any Series 2022 Bond, the Board, the Trustee, and any agent of the Board or the Trustee may treat the person in whose name any Series 2022 Bond is registered as the absolute owner thereof for all purposes (except to the extent otherwise provided hereinabove and in the Bond Resolution with respect to Record Dates and Special Record Dates for the payment of interest), whether or not such Series 2022 Bonds shall be overdue, and shall not be bound by any notice to the contrary.

This Series 2022 Bond is one of a series of the Board's Taxable Auxiliary Revenue Refunding Bonds, Series 2022, issued in the original aggregate principal amount of \$_____. The Series 2022 Bonds are issued by the Board pursuant to Chapter 14-A of Title 39 of the Louisiana Revised Statutes of 1950, as amended (La. R.S. 39:1444 through 1456 (the "*Refunding Act*") and other constitutional and statutory authority, which authorize the Board to borrow money, issue refunding bonds, and pledge revenues for the payment thereof. The Series 2022 Bonds are issued pursuant to the Bond Resolution for the purpose of providing funds for the purpose of (i) refunding (a) [all/a portion] of the Board's outstanding Series 2012 Bonds, (b) [all/a portion] of the Board's outstanding Series 2013 Bonds, (c) [all/a portion] of the Board's outstanding Series 2014 Bonds and (d) [all/a portion] of the Board's outstanding Series 2016A Bonds (each as defined in the Bond Resolution and, collectively, the "*Refunded Bonds*"), (ii) [***funding a reserve fund or paying the premium for a reserve fund insurance policy or surety bond, and (iii)**] paying the costs of issuance of the Series 2022 Bonds[**, including the premium for a bond insurance policy**], all subject to the terms and conditions contained in the Bond Resolution.

THE SERIES 2022 BONDS SHALL BE SPECIAL AND LIMITED OBLIGATIONS OF THE BOARD PAYABLE SOLELY FROM AUXILIARY REVENUES, THE LAB SCHOOL REVENUES AND THE RECREATIONAL SPORTS FEE REVENUES; PROVIDED THAT (i) THE PLEDGE OF THE LAB SCHOOL REVENUES WILL LAPSE ON THE LATER OF (A) JULY 1, [**2034**] AND (B) THE MATURITY DATE OF ANY BONDS ISSUED TO FINANCE OR REFINANCE PROJECTS FOR THE LAB SCHOOL AND (ii) THE PLEDGE OF RECREATIONAL SPORTS FEE REVENUES WILL LAPSE ON THE LATER OF (A) JULY 1, [**2043**] AND (B) THE MATURITY DATE OF ANY BONDS ISSUED TO FINANCE OR REFINANCE PROJECTS FOR THE STUDENT RECREATIONAL SPORTS COMPLEX . THE SERIES 2022 BONDS SHALL NOT CONSTITUTE AN INDEBTEDNESS OR PLEDGE OF THE GENERAL CREDIT OF THE UNIVERSITY, LSU, THE BOARD, THE STATE OR ANY POLITICAL SUBDIVISION THEREOF WITHIN THE MEANING OF ANY CONSTITUTIONAL OR STATUTORY LIMITATION OF INDEBTEDNESS AND SHALL CONTAIN A RECITAL TO THAT EFFECT. NEITHER THE STATE NOR ANY AGENCY

OR POLITICAL SUBDIVISION THEREOF, OTHER THAN THE BOARD, SHALL BE OBLIGATED TO PAY THE PRINCIPAL OF THE SERIES 2022 BONDS OR THE INTEREST THEREON, AND THE SERIES 2019B BONDS SHALL NOT BE DEEMED TO CONSTITUTE A DEBT OR LIABILITY OF THE STATE OR ANY AGENCY OR POLITICAL SUBDIVISION OR AGENCY THEREOF, OTHER THAN THE BOARD.

THE AUXILIARY REVENUES, THE LAB SCHOOL REVENUES AND THE RECREATIONAL SPORTS FEE REVENUES ARE PLEDGED TO THE PAYMENT OF THE SERIES 2022 BONDS ON A PARITY WITH THE BOARD'S OUTSTANDING PARITY BONDS AND ANY ADDITIONAL BONDS; PROVIDED THAT (i) THE LAB SCHOOL REVENUES SHALL BE SO PLEDGED ONLY UNTIL THE LATER OF (A) JULY 1, [**2034**] AND (B) THE MATURITY DATE OF ANY BONDS ISSUED TO FINANCE OR REFINANCE PROJECTS FOR THE LAB SCHOOL AND (ii) THE RECREATIONAL SPORTS FEE REVENUES SHALL BE SO PLEDGED ONLY UNTIL THE LATER OF (A) JULY 1, [**2043**] AND (B) THE MATURITY DATE OF ANY BONDS ISSUED TO FINANCE OR REFINANCE PROJECTS FOR THE STUDENT RECREATIONAL SPORTS COMPLEX.

For purposes of the Twentieth Supplemental Resolution and this Series 2022 Bond, references therein and herein to the term "Auxiliary Revenues" shall be deemed to include Lab School Revenues and Recreational Sports Fee Revenues for the purpose of describing the pledge thereof, with the caveat set forth in the foregoing paragraphs.

The Series 2022 Bonds are equally and ratably payable from a pledge under the Bond Resolution of the Auxiliary Revenues, and the Series 2022 Bonds shall enjoy a pledge of Auxiliary Revenues under the Bond Resolution. Obligations in addition to the Series 2022 Bonds, subject to expressed conditions, may be issued and made payable from the Auxiliary Revenues having a pledge thereof (i) subordinate and junior to the pledge relative to the Series 2022 Bonds, or (ii) subject to additional expressed conditions, on a parity with the Series 2022 Bonds, as provided in the Bond Resolution. The Series 2022 Bonds defined hereinabove, are payable on a parity with the Board's outstanding [**i) Auxiliary Revenue Refunding Bonds, Series 2012, issued in the original aggregate principal amount of \$41,615,000 (to the extent not refunded by the Series 2022 Bonds), (iii) Auxiliary Revenue Bonds, Series 2013, issued in the original aggregate principal amount of \$101,180,000 (to the extent not refunded by the Series 2022 Bonds), (iv) Auxiliary Revenue Refunding Bonds, Series 2014, issued in the original aggregate principal amount of \$81,880,000 (to the extent not refunded by the Series 2022 Bonds), (v) Auxiliary Revenue Refunding Bonds, Series 2016A issued in the original aggregate principal amount of \$137,000,000 (to the extent not refunded by the Series 2022 Bonds), (vii) Taxable Auxiliary Revenue Refunding Bonds, Series 2016B issued in the original aggregate principal amount of \$16,320,000 and (viii) Taxable Auxiliary Revenue Refunding Bonds, Series 2019 issued in the original aggregate principal amount of \$72,355,000.

Auxiliary Revenues are defined to mean (i) the gross amount of all funds, monies or revenues held by the University and any earnings thereon derived or to be derived by Auxiliary Enterprises from self-generated revenues from all fees, rates, rentals, charges or other receipts or income received from students or the public at large in connection with any undertaking, utilization or operation of Auxiliary Enterprises or Auxiliary Facilities, including operation or

management thereof by private entities on behalf of the Auxiliary Enterprises, prior to the payment of Current Expenses; and (ii) all Funds and Accounts held pursuant to the Bond Resolution except any fund created to hold monies pending rebate to the United States or for payment of costs of issuance of the Series 2022 Bonds. Auxiliary Revenues shall not include funds, if any, appropriated by the Legislature of the State from time to time. Lab School Revenues are also pledged as Auxiliary Revenues as security for the payment of all Bonds Outstanding under the General Bond Resolution and any Supplemental Resolutions until the later of (i) July 1, [**2034**] and (ii) the maturity date of any Bonds issued to finance or refinance projects for the Lab School. Recreational Sports Fee Revenues are also pledged as Auxiliary Revenues as security for the payment of all Bonds Outstanding under the General Bond Resolution and any Supplemental Resolutions until the later of (i) July 1, [**2043**] and (ii) the maturity date of any Bonds issued to finance or refinance projects for the Student Recreational Sports Complex.

Reference is made to the Bond Resolution and any and all modifications and amendments thereof on file with the Trustee for the provisions, among others, with respect to the custody and application of the proceeds of the Series 2022 Bonds, for a description of the nature and extent of the revenues pledged for the payment for the Series 2022 Bonds, the nature and extent and manner of enforcement of the pledge, the rights and remedies of the Owners of the Series 2022 Bonds with respect thereto, the terms and conditions upon which the Series 2022 Bonds are issued and a statement of rights, duties, immunities and obligations of the Board and the rights of the Owners. The acceptance of the terms and conditions of the Bond Resolution is an explicit and material part of the consideration of the Board's issuance of this Series 2022 Bond, and each owner, by acceptance of this Series 2022 Bond, agrees and assents to all such terms and conditions as if fully set forth herein.

To the extent and in the respects permitted by the Bond Resolution, the provisions of the Bond Resolution and of any resolution amendatory thereof or supplemental thereto may be modified or amended by action on behalf of the Board taken in the manner and subject to the conditions and exceptions prescribed in the Bond Resolution. The pledge of the Auxiliary Revenues and other duties of the Board under the Bond Resolution may be discharged at or prior to the maturity or redemption of the Series 2022 Bonds upon the making of provision for the payment thereof on the terms and conditions set forth in the Bond Resolution.

The Board covenants and agrees with the Owner of this Series 2022 Bond and with each and every person who may become the Owner hereof that it will keep and perform all of the covenants of the Bond Resolution.

No recourse shall be had for the payment of the principal of, premium, if any, and interest on this Series 2022 Bond or for any claim based thereon or otherwise in respect to the Bond Resolution against any individual member of the Board, past, present or future, either directly or through the Board, or through any successor body corporate, whether by virtue of any constitution, statute or rule of law, or by the enforcement of any penalty or otherwise, all such liability, if any, being by the acceptance of this Series 2022 Bond and as a part of the consideration of its issuance specially waived and released. The obligation of the Board, as a body corporate, to the Owner hereof is limited to applying funds, as set forth above and as more

fully delineated in the Bond Resolution, and to otherwise complying with the contractual provisions therein.

It is hereby certified that all acts, conditions and things required to be done precedent to and in the issuance of this Series 2022 Bond and the Series of which it is a part have been properly done, have happened and have been performed in regular and due time, form and manner as required by the Constitution and laws of the State and the proceedings herein mentioned, and that the Series 2022 Bonds do not exceed any constitutional or statutory limitation.

This Series 2022 Bond shall not be valid or obligatory for any purpose until the Trustee shall have manually signed the certificate of authentication hereon.

IN TESTIMONY WHEREOF, the Board of Supervisors of Louisiana State University and Agricultural and Mechanical College has caused this Series 2022 Bond to be signed and executed in the name and on behalf of the Board with the manual or facsimile signature of its Chairman, and to be attested, signed, subscribed and executed with the manual or facsimile signature of its Secretary; and has caused a manual or facsimile of the seal of the Board to be affixed hereon all as of the date specified above.

**BOARD OF SUPERVISORS OF LOUISIANA
STATE UNIVERSITY AND AGRICULTURAL
AND MECHANICAL COLLEGE**

By _____
Name: Remy Voisin Starns
Title: Chairman

[SEAL]

ATTEST:

Name: William F. Tate IV
Title: Secretary

CERTIFICATE OF AUTHENTICATION

This is one of the Series 2022 Bonds described in the within-mentioned Bond Resolution, and this Series 2022 Bond has been duly registered on the registration records kept by the undersigned as Trustee for such Series 2022 Bonds.

DATE OF AUTHENTICATION

THE BANK OF NEW YORK MELLON
TRUST COMPANY, N.A.,
as Trustee

By: _____
Authorized Signatory

ASSIGNMENT

FOR VALUE RECEIVED, the undersigned sells, assigns, and transfers unto:

SOCIAL SECURITY OR FEDERAL EMPLOYER
IDENTIFICATION NUMBER OF ASSIGNEE

(Name and Address of Assignee)

the within bond and does hereby irrevocably constitute and appoint _____,

attorney, to transfer said bond on the books kept for registration thereof with full power of
substitution in the premises.

Dated: _____

Signature of Registered Owner:

NOTICE: The signature to this assignment must correspond with the name of the registered owner as it appears upon the face of the within bond in every particular, without alteration or enlargement or any change whatever.

Signature guaranteed:

(Bank, Trust Company, or Firm

TRANSFER FEE MAY BE REQUIRED

[STATEMENT OF INSURANCE**

_____, has delivered its municipal bond insurance policy (the "*Policy*") with respect to the scheduled payments due of principal of and interest on this Series 2022 Bond to The Bank of New York Mellon Trust Company, N.A., Jacksonville, Florida, or its successor, as paying agent for the Series 2022 Bonds (the "*Paying Agent*"). Said Policy is on file and available for inspection at the principal office of the Paying Agent and a copy thereof may be obtained from _____ or the Paying Agent. All payments required to be made under the Policy shall be made in accordance with the provisions thereof. The owner of this Series 2022 Bond acknowledges and consents to the subrogation rights of _____ as more fully set forth in the Policy.**]

CERTIFICATE AS TO LEGAL OPINION

The undersigned hereby certifies that the following approving legal opinion of Breazeale, Sachse & Wilson, L.L.P., Baton Rouge, Louisiana, in substantially the following form was delivered to the Board of Supervisors of Louisiana State University and Agricultural and Mechanical College, and that the opinion was dated and issued as of the date of original delivery of and payment to the Board for the Series 2022 Bonds.

**BOARD OF SUPERVISORS OF LOUISIANA
STATE UNIVERSITY AND AGRICULTURAL
AND MECHANICAL COLLEGE**

Secretary

REQUISITION FORM TO PAY SERIES 2022 COSTS OF ISSUANCE

\$ _____
**BOARD OF SUPERVISORS OF
LOUISIANA STATE UNIVERSITY
AND AGRICULTURAL AND MECHANICAL COLLEGE
Taxable Auxiliary Revenue Refunding Bonds
Series 2022**

The Bank of New York Mellon Trust Company, N.A.,
as Trustee
10161 Centurion Parkway
Jacksonville, Florida 32256

Date: _____

Requisition Number: _____

The undersigned Authorized Board Representative, acting for and on behalf of the Board of Supervisors of Louisiana State University and Agricultural and Mechanical College (the "*Board*"), pursuant to a General Bond Resolution adopted by the Board on June 17, 1994, as amended (the "*General Bond Resolution*"), and the Twentieth Supplemental Resolution adopted by the Board on October 29, 2021 and executed _____, 202__ (the "*Twentieth Supplemental Resolution*") relating to the above captioned issue of Bonds, hereby request payment be made from amounts on deposit in the Series 2022 Costs of Issuance Account of the Series 2022 Bond Proceeds Fund held by the Trustee pursuant to the Twentieth Supplemental Resolution to the person, firm or corporation in the amount and for the purpose set forth below:

Name and address of payee:

Amount of Payment: \$ _____

Purpose of Payment (if a reimbursement to the Board, identify payee(s), purposes represented by such reimbursement and costs heretofore paid).

The undersigned Authorized Board Representative further certifies with respect to this Requisition as follows:

1. The payment set forth herein is to be or was made or incurred in connection with the issuance of the above captioned Series 2022 Bonds;

2. The amount paid or to be paid, as set forth herein, is reasonable, is presently due and payable, and is a proper charge against the Series 2022 Costs of Issuance Account of the Series 2022 Bond Proceeds Fund and has not been paid;

3. If the Board is seeking reimbursement for payment of items qualifying as Series 2022 Costs of Issuance hereunder, evidence of prior payment of the same is attached hereto.

**BOARD OF SUPERVISORS OF LOUISIANA
STATE UNIVERSITY AND AGRICULTURAL
AND MECHANICAL COLLEGE**

By: _____
Authorized Board Representative

Approved for payment and paid: _____, 20____

Authorized Officer
of Trustee: _____

REFUNDED BONDS - SERIES 2012

**BOARD OF SUPERVISORS OF
LOUISIANA STATE UNIVERSITY AND
AGRICULTURAL AND MECHANICAL COLLEGE
AUXILIARY REVENUE REFUNDING BONDS
SERIES 2012**

**Maturity Date
(July 1)**

Interest Rate

Principal Amount

CUSIP

REFUNDED BONDS - SERIES 2013

**BOARD OF SUPERVISORS OF
LOUISIANA STATE UNIVERSITY AND
AGRICULTURAL AND MECHANICAL COLLEGE
AUXILIARY REVENUE BONDS
SERIES 2013**

**Maturity Date
(July 1)**

Interest Rate

Principal Amount

CUSIP

REFUNDED BONDS - SERIES 2014

**BOARD OF SUPERVISORS OF
LOUISIANA STATE UNIVERSITY AND
AGRICULTURAL AND MECHANICAL COLLEGE
AUXILIARY REVENUE REFUNDING BONDS
SERIES 2014**

**Maturity Date
(July 1)**

Interest Rate

Principal Amount

CUSIP

REFUNDED BONDS - SERIES 2016A

**BOARD OF SUPERVISORS OF
LOUISIANA STATE UNIVERSITY AND
AGRICULTURAL AND MECHANICAL COLLEGE
AUXILIARY REVENUE REFUNDING BONDS
SERIES 2016A**

**Maturity Date
(July 1)**

Interest Rate

Principal Amount

CUSIP

**FORM OF NOTICE OF REDEMPTION
FOR SERIES 2012 REFUNDED BONDS**

OF

**BOARD OF SUPERVISORS OF
LOUISIANA STATE UNIVERSITY AND
AGRICULTURAL AND MECHANICAL COLLEGE
AUXILIARY REVENUE REFUNDING BONDS
SERIES 2012**

Dated: _____, 2022

[deliver to Holders at least 30 days, but not more than 60 days, prior to July 1, 2022]

The Bank of New York Mellon Trust Company, N.A.,
as Trustee for the captioned bonds
Jacksonville, Florida

NOTICE IS HEREBY GIVEN pursuant to a General Bond Resolution adopted by the Board of Supervisors of Louisiana State University and Agricultural and Mechanical College (the "Board") on June 17, 1994, as amended and supplemented to the date hereof (the "General Bond Resolution"), and particularly as supplemented by the Fifteenth Supplemental Resolution adopted by the Board on June 8, 2012, and executed and effective on August 7, 2012 (the "Fifteenth Supplemental Resolution" and, together with the General Bond Resolution, the "Bond Resolution") that, pursuant to Section 3.02 of the Fifteenth Supplemental Resolution, the Board has exercised its option to redeem the following Series 2012 Bonds (the "Refunded Bonds") on July 1, 2022 (the "Redemption Date"), at a price of 100% of the principal amount thereof plus accrued interest to the Redemption Date.

**Maturity Date
(July 1)**

Interest Rate

Principal Amount

CUSIP

Upon the surrender of Refunded Bonds to the principal office of the Trustee on the Redemption Date, the Refunded Bonds will be redeemed in whole at a price of 100% and accrued interest to the Redemption Date.

On or before the Redemption Date, the holders of the Refunded Bonds should present the Refunded Bonds to the Trustee at its principal office for payment as follows:

The Bank of New York Mellon Trust Company, N.A.
10161 Centurion Parkway
Jacksonville, Florida 32256

No further interest shall accrue on the Refunded Bonds on or after the Redemption Date, provided that funds sufficient for such redemption are held by the Trustee on the Redemption Date.

THE BANK OF NEW YORK MELLON TRUST COMPANY, N.A.

IMPORTANT TAX INFORMATION

Under federal income tax law, paying agents may be required to withhold 28% of payments to holders presenting their securities for redemption or for payment at maturity who have failed to furnish a taxpayer identification number to the paying agent, certified to be correct under penalties of perjury. Certification may be made to the paying agent on Form W-9, a copy of which will be provided upon request.

**FORM OF NOTICE OF REDEMPTION
FOR SERIES 2013 REFUNDED BONDS**

OF

**BOARD OF SUPERVISORS OF
LOUISIANA STATE UNIVERSITY AND
AGRICULTURAL AND MECHANICAL COLLEGE
AUXILIARY REVENUE BONDS
SERIES 2013**

Dated: _____, 2023

[deliver to Holders at least 30 days, but not more than 60 days, prior to July 1, 2023]

The Bank of New York Mellon Trust Company, N.A.,
as Trustee for the captioned bonds
Jacksonville, Florida

NOTICE IS HEREBY GIVEN pursuant to a General Bond Resolution adopted by the Board of Supervisors of Louisiana State University and Agricultural and Mechanical College (the "*Board*") on June 17, 1994, as amended and supplemented to the date hereof (the "*General Bond Resolution*"), and particularly as supplemented by the Sixteenth Supplemental Resolution adopted by the Board on March 8, 2013, and executed and effective on April 25, 2013 (the "*Sixteenth Supplemental Resolution*" and, together with the General Bond Resolution, the "*Bond Resolution*") that, pursuant to Section 3.02 of the Sixteenth Supplemental Resolution, the Board has exercised its option to redeem the following Series 2013 Bonds (the "*Refunded Bonds*") on July 1, 2023 (the "*Redemption Date*"), at a price of 100% of the principal amount thereof plus accrued interest to the Redemption Date.

Maturity Date
(July 1)

Interest Rate

Principal Amount

CUSIP

Upon the surrender of Refunded Bonds to the principal office of the Trustee on the Redemption Date, the Refunded Bonds will be redeemed in whole at a price of 100% and accrued interest to the Redemption Date.

On or before the Redemption Date, the holders of the Refunded Bonds should present the Refunded Bonds to the Trustee at its principal office for payment as follows:

The Bank of New York Mellon Trust Company, N.A.
10161 Centurion Parkway
Jacksonville, Florida 32256

No further interest shall accrue on the Refunded Bonds on or after the Redemption Date, provided that funds sufficient for such redemption are held by the Trustee on the Redemption Date.

THE BANK OF NEW YORK MELLON TRUST COMPANY, N.A.

IMPORTANT TAX INFORMATION

Under federal income tax law, paying agents may be required to withhold 28% of payments to holders presenting their securities for redemption or for payment at maturity who have failed to furnish a taxpayer identification number to the paying agent, certified to be correct under penalties of perjury. Certification may be made to the paying agent on Form W-9, a copy of which will be provided upon request.

**FORM OF NOTICE OF REDEMPTION
FOR SERIES 2014 REFUNDED BONDS**

OF

**BOARD OF SUPERVISORS OF
LOUISIANA STATE UNIVERSITY AND
AGRICULTURAL AND MECHANICAL COLLEGE
AUXILIARY REVENUE REFUNDING BONDS
SERIES 2014**

Dated: _____, 2024

[deliver to Holders at least 30 days, but not more than 60 days, prior to July 1, 2024]

The Bank of New York Mellon Trust Company, N.A.,
as Trustee for the captioned bonds
Jacksonville, Florida

NOTICE IS HEREBY GIVEN pursuant to a General Bond Resolution adopted by the Board of Supervisors of Louisiana State University and Agricultural and Mechanical College (the "*Board*") on June 17, 1994, as amended and supplemented to the date hereof (the "*General Bond Resolution*"), and particularly as supplemented by the Seventeenth Supplemental Resolution adopted by the Board on September 12, 2014, and executed and effective on October 16, 2014 (the "*Seventeenth Supplemental Resolution*" and, together with the General Bond Resolution, the "*Bond Resolution*") that, pursuant to Section 3.02 of the Seventeenth Supplemental Resolution, the Board has exercised its option to redeem the following Series 2014 Bonds (the "*Refunded Bonds*") on July 1, 2024 (the "*Redemption Date*"), at a price of 100% of the principal amount thereof plus accrued interest to the Redemption Date.

Maturity Date
(July 1)

Interest Rate

Principal Amount

CUSIP

Upon the surrender of Refunded Bonds to the principal office of the Trustee on the Redemption Date, the Refunded Bonds will be redeemed in whole at a price of 100% and accrued interest to the Redemption Date.

On or before the Redemption Date, the holders of the Refunded Bonds should present the Refunded Bonds to the Trustee at its principal office for payment as follows:

The Bank of New York Mellon Trust Company, N.A.
10161 Centurion Parkway
Jacksonville, Florida 32256

No further interest shall accrue on the Refunded Bonds on or after the Redemption Date, provided that funds sufficient for such redemption are held by the Trustee on the Redemption Date.

THE BANK OF NEW YORK MELLON TRUST COMPANY, N.A.

IMPORTANT TAX INFORMATION

Under federal income tax law, paying agents may be required to withhold 28% of payments to holders presenting their securities for redemption or for payment at maturity who have failed to furnish a taxpayer identification number to the paying agent, certified to be correct under penalties of perjury. Certification may be made to the paying agent on Form W-9, a copy of which will be provided upon request.

**FORM OF NOTICE OF REDEMPTION
FOR SERIES 2016A REFUNDED BONDS**

OF

**BOARD OF SUPERVISORS OF
LOUISIANA STATE UNIVERSITY AND
AGRICULTURAL AND MECHANICAL COLLEGE
AUXILIARY REVENUE REFUNDING BONDS
SERIES 2016A**

Dated: _____, 2026

[deliver to Holders at least 30 days, but not more than 60 days, prior to July 1, 2026]

The Bank of New York Mellon Trust Company, N.A.,
as Trustee for the captioned bonds
Jacksonville, Florida

NOTICE IS HEREBY GIVEN pursuant to a General Bond Resolution adopted by the Board of Supervisors of Louisiana State University and Agricultural and Mechanical College (the "Board") on June 17, 1994, as amended and supplemented to the date hereof (the "General Bond Resolution"), and particularly as supplemented by the Eighteenth Supplemental Resolution adopted by the Board on October 21, 2016, and executed and effective on November 15, 2016 (the "Eighteenth Supplemental Resolution" and, together with the General Bond Resolution, the "Bond Resolution") that, pursuant to Section 3.02 of the Eighteenth Supplemental Resolution, the Board has exercised its option to redeem the following Series 2016A Bonds (the "Refunded Bonds") on July 1, 2026 (the "Redemption Date"), at a price of 100% of the principal amount thereof plus accrued interest to the Redemption Date.

Maturity Date
(July 1)

Interest Rate

Principal Amount

CUSIP

Upon the surrender of Refunded Bonds to the principal office of the Trustee on the Redemption Date, the Refunded Bonds will be redeemed in whole at a price of 100% and accrued interest to the Redemption Date.

On or before the Redemption Date, the holders of the Refunded Bonds should present the Refunded Bonds to the Trustee at its principal office for payment as follows:

The Bank of New York Mellon Trust Company, N.A.
10161 Centurion Parkway
Jacksonville, Florida 32256

No further interest shall accrue on the Refunded Bonds on or after the Redemption Date, provided that funds sufficient for such redemption are held by the Trustee on the Redemption Date.

THE BANK OF NEW YORK MELLON TRUST COMPANY, N.A.

IMPORTANT TAX INFORMATION

Under federal income tax law, paying agents may be required to withhold 28% of payments to holders presenting their securities for redemption or for payment at maturity who have failed to furnish a taxpayer identification number to the paying agent, certified to be correct under penalties of perjury. Certification may be made to the paying agent on Form W-9, a copy of which will be provided upon request.

EXHIBIT B

NOTICE OF INTENTION TO ISSUE BONDS

Notice is hereby given that, pursuant to a resolution adopted at its meeting of October 29, 2021 (the "Authorizing Resolution"), the Board of Supervisors of Louisiana State University and Agricultural and Mechanical College (the "Board") intends to issue its taxable Auxiliary Revenue Refunding Bonds, in one or more series (the "Bonds"), in an aggregate principal amount not to exceed \$165,000,000. Sections 2181 through 2193 and 3351(A)(4) of Title 17 and Chapter 14-A of Title 39 of the Louisiana Revised Statutes of 1950, as amended, and Article VII, Section 6(C) of the Constitution of the State of Louisiana of 1974, and other constitutional and statutory authority, authorize the Board to borrow money and to issue refunding bonds and pledge revenues to guarantee payment thereof in accordance with law and with the approval of the State Bond Commission. The proceeds of the Bonds will be made available to the Board for the benefit of Louisiana State University and Agricultural and Mechanical College ("LSU") to finance or reimburse the costs of (a) refunding all or a portion of the Board's outstanding (i) Auxiliary Revenue Refunding Bonds, Series 2012, (ii) Auxiliary Revenue Bonds, Series 2013, (iii) Auxiliary Revenue Refunding Bonds, Series 2014, and (vi) Auxiliary Revenue Refunding Bonds, Series 2016A (collectively, the "Prior Bonds") (b) funding a reserve fund or paying the premium for a reserve fund insurance policy or surety bond, if necessary, and (c) paying the costs of issuance of the Bonds, including, without limitation, the premium for a municipal bond insurance policy, if deemed to be financially advantageous to the Board. The Bonds will be in fully registered form, will be issued as tax-exempt and/or taxable obligations in one or more series in an aggregate principal amount not to exceed \$165,000,000, will mature not later than 30 years from their dated date and will bear interest payable at a fixed rate not to exceed six percent (6%) per annum. The Bonds will not be a general obligation or pledge of the full faith and credit of the State of Louisiana, but will be solely a revenue obligation of the Board payable from Auxiliary Revenues (as defined in the General Bond Resolution adopted Jun 17, 1994, as supplemented and amended to date (the "General Bond Resolution"), and as further supplemented by the Twentieth Supplemental Resolution adopted by the Board on October 29, 2021 (the "Twentieth Supplemental Resolution" and, together with the General Bond Resolution, the "Bond Resolution"), consisting of Auxiliary Revenues derived from certain Auxiliary Enterprises, including, without limitation, athletics, residential life, parking, the student union and other miscellaneous auxiliaries and certain other revenues that have been dedicated and pledged to payment of bonds issued under the Bond Resolution. The Bonds will be secured by the Auxiliary Revenues on a parity with the Board's outstanding Series 2012 Bonds (to the extent not refunded in their entirety by the Bonds), Series 2013 Bonds (to the extent not refunded in their entirety by the Bonds), Series 2014 Bonds (to the extent not refunded in their entirety by the Bonds), Series 2016A Bonds (to the extent not refunded in their entirety by the Bonds), Series 2016B Bonds and Series 2019 Bonds, each as defined in the Board's General Bond Resolution. Within thirty (30) days after publication of this Notice of Intention, any person in interest may contest the legality of the Authorizing Resolution or the Bond Resolution, any provision of the Bonds to be issued pursuant to the Bond Resolution, the provisions securing the Bonds and the validity of all other provisions and proceedings relating to the authorization and issuance of the Bonds. If no action or proceeding is instituted within the thirty (30) days, no person may contest the validity of the Bonds, the provisions of the Authorizing Resolution or the Bond Resolution, the security of the Bonds or the validity of any other provisions or proceedings relating to their authorization and issuance, and the Bonds shall be presumed conclusively to be legal. Thereafter, no court shall have authority to inquire into such matters. Draft copies of the Bond Resolution are available for inspection at the offices of Donna K. Torres, Interim Executive Vice President for Finance and Administration/CFO, Louisiana State University, 330 Thomas Boyd Hall, Baton Rouge, Louisiana 70803.

PRELIMINARY OFFICIAL STATEMENT DATED [_____, 2021]

REFUNDING ISSUE – BOOK-ENTRY ONLY

RATINGS: Moody's: "___"
Fitch: "___"
See "RATINGS"

In the opinion of Breazeale, Sachse & Wilson, L.L.P., Bond Counsel, under existing law, interest on the Series 2022 Bonds is included in gross income for federal income tax purposes. Further, pursuant to the Refunding Act, the Series 2022 Bonds and the income therefrom shall be exempt from all taxation by the State of Louisiana or any political subdivision thereof. See "TAX MATTERS" herein and the proposed form of opinion of Bond Counsel attached hereto as "APPENDIX C – PROPOSED FORM OF OPINION OF BOND COUNSEL."



[\$_____]*
BOARD OF SUPERVISORS OF LOUISIANA STATE UNIVERSITY
AND AGRICULTURAL AND MECHANICAL COLLEGE
TAXABLE AUXILIARY REVENUE REFUNDING BONDS
SERIES 2022

Dated: Date of Delivery

Due: July 1, as shown on inside cover

The Board of Supervisors of Louisiana State University and Agricultural and Mechanical College (the "Board") is offering its Taxable Auxiliary Revenue Refunding Bonds, Series 2022, in an aggregate principal amount of [\$_____]* (the "Series 2022 Bonds"), pursuant to and secured by a General Bond Resolution adopted by the Board on June 17, 1994, as supplemented and amended (the "General Bond Resolution"), and as further supplemented by the Twentieth Supplemental Resolution approved October 29, 2021, and to be executed and effective on the date of delivery of the Series 2022 Bonds (the "Twentieth Supplemental Resolution" and, together with the General Bond Resolution, the "Bond Resolution"). The Twentieth Supplemental Resolution appoints The Bank of New York Mellon Trust Company, N.A., as Trustee and Paying Agent for the Series 2022 Bonds (the "Trustee" or "Paying Agent").

The proceeds of the Series 2022 Bonds will be used by the Board, together with other available funds, for the purpose of (a) refunding all or a portion of the Board's outstanding (i) Auxiliary Revenue Refunding Bonds, Series 2012 (the "Series 2012 Refunded Bonds"), (ii) Auxiliary Revenue Refunding Bonds, Series 2013 (the "Series 2013 Refunded Bonds"), (iii) Auxiliary Revenue Refunding Bonds, Series 2014 (the "Series 2014 Refunded Bonds"), (iv) Auxiliary Revenue Refunding Bonds, Series 2016A (the "Series 2016A Refunded Bonds"), and, together with the Series 2012 Refunded Bonds, the Series 2013 Refunded Bonds and the Series 2014 Refunded Bonds, the "Refunded Bonds") and (b) paying the costs of issuance of the Series 2022 Bonds.

The payment of the principal of and the interest on the Series 2022 Bonds is secured, subject to certain limitations described herein, by a pledge (on a senior lien basis as to the Subordinate Lease Obligations, as defined herein) to the Trustee of certain Auxiliary Revenues, defined herein, derived from self-generated revenues from all fees, rates, rentals, charges or other receipts or income received from students or the public at large in connection with any undertaking, utilization or operation of Auxiliary Enterprises (defined herein) at Louisiana State University and Agricultural and Mechanical College (the "University"). The definition of Auxiliary Enterprises may be modified from time to time, as provided in the General Bond Resolution. See "SECURITY FOR THE SERIES 2022 BONDS" and "THE AUXILIARY ENTERPRISES" herein.

The Series 2022 Bonds will be initially issued as fully registered bonds in denominations of \$5,000 or any integral multiple in excess thereof, registered in the name of Cede & Co., as nominee of The Depository Trust Company, New York, New York ("DTC"). DTC will act as securities depository for the Series 2022 Bonds. Purchases of the Series 2022 Bonds may be made only in book-entry form in authorized denominations by credit to participating broker-dealers and other institutions on the books of DTC as described herein. Principal of and interest on the Series 2022 Bonds will be payable by the Trustee to DTC, which will remit such payments in accordance with its normal procedures, as described herein. Interest will be payable on January 1 and July 1 of each year, commencing on July 1, 2022. See "THE SERIES 2022 BONDS" herein.

The Series 2022 Bonds are subject to extraordinary optional, optional and mandatory sinking fund redemption prior to maturity as described under "THE SERIES 2022 BONDS – Redemption Provisions."

The Series 2022 Bonds are secured by the Bond Resolution on a parity with the Board's Outstanding Parity Bonds (defined herein). The Board also has outstanding certain capital lease obligations which are payable solely from (but not secured by) Auxiliary Revenues. Pursuant to the General Bond Resolution, such obligations are subordinate to the Board's payment obligations with respect to the Series 2022 Bonds. See "OUTSTANDING PARITY BONDS" herein.

THE SERIES 2022 BONDS ARE SPECIAL AND LIMITED OBLIGATIONS OF THE BOARD PAYABLE SOLELY FROM AUXILIARY REVENUES, THE LAB SCHOOL REVENUES AND THE RECREATIONAL SPORTS FEE REVENUES; PROVIDED THAT (a) THE PLEDGE OF THE LAB SCHOOL REVENUES WILL LAPSE ON THE LATER OF (i) JULY 1, 2034 AND (ii) THE MATURITY DATE OF ANY BONDS ISSUED TO FINANCE OR REFINANCE PROJECTS FOR THE LAB SCHOOL AND (b) THE PLEDGE OF RECREATIONAL SPORTS FEE REVENUES WILL LAPSE ON THE LATER OF (i) JULY 1, 2043 (THE FINAL MATURITY DATE OF THE SERIES 2005 BONDS) AND (ii) THE MATURITY DATE OF ANY BONDS ISSUED TO FINANCE OR REFINANCE PROJECTS FOR THE STUDENT RECREATIONAL SPORTS COMPLEX. THE SERIES 2022 BONDS SHALL NOT CONSTITUTE AN INDEBTEDNESS OR PLEDGE OF THE GENERAL CREDIT OF THE UNIVERSITY, LSU, THE BOARD, THE STATE OR ANY POLITICAL SUBDIVISION THEREOF WITHIN THE MEANING OF ANY CONSTITUTIONAL OR STATUTORY LIMITATION OF INDEBTEDNESS AND SHALL CONTAIN A RECITAL TO THAT EFFECT. NEITHER THE STATE NOR ANY AGENCY OR POLITICAL SUBDIVISION THEREOF, OTHER THAN THE BOARD, SHALL BE OBLIGATED TO PAY THE PRINCIPAL OF THE SERIES 2022 BONDS OR THE INTEREST THEREON, AND THE SERIES 2022 BONDS SHALL NOT BE DEEMED TO CONSTITUTE A DEBT OR LIABILITY OF THE STATE OR ANY AGENCY OR POLITICAL SUBDIVISION OR AGENCY THEREOF, OTHER THAN THE BOARD.

This cover page contains certain information for quick reference only. It is not a summary of this issue. Investors must read the entire Official Statement, including all Appendices attached hereto, to obtain information essential to the making of an informed investment decision.

The Series 2022 Bonds are offered in book-entry only form when, as and if issued by the Board and accepted by the Underwriter, subject to prior sale, withdrawal or modification of the offer without notice, and to the approving opinions of Breazeale, Sachse & Wilson, L.L.P., Baton Rouge, Louisiana, Bond Counsel. Certain other legal matters will be passed upon for the Board by its special counsel, Breazeale, Sachse & Wilson, L.L.P., Baton Rouge, Louisiana. Certain other legal matters will be passed upon for the Trustee and the Escrow Trustee by its counsel, Gregory A. Pletsch & Associates, Baton Rouge, Louisiana. Foley & Judell, L.L.P., New Orleans, Louisiana, will pass upon certain matters as counsel to the Underwriter. It is expected that the Series 2022 Bonds in definitive form will be available for delivery through the facilities of DTC in New York, New York, on or about [_____, 2022].



The date of this Official Statement is [_____, 2021]

* Preliminary, subject to change.

The information contained in this Preliminary Official Statement is subject to completion or amendment. These securities may not be sold nor may offers to buy be accepted prior to the time the Official Statement is delivered in final form. Under no circumstances shall this Preliminary Official Statement constitute an offer to sell or the solicitation of an offer to buy, nor shall there be any sale of these securities in any jurisdiction in which such offer, solicitation or sale would be unlawful prior to registration or qualification of the securities laws of any such jurisdiction. As of this date, this Preliminary Official Statement has been deemed final by the Board for purposes of Rule 15c2-12 of the Securities and Exchange Commission.

**BOARD OF SUPERVISORS OF LOUISIANA STATE UNIVERSITY
AND AGRICULTURAL AND MECHANICAL COLLEGE
TAXABLE AUXILIARY REVENUE REFUNDING BONDS
SERIES 2022**

**MATURITY SCHEDULE
(Base CUSIP No. _____[†])**

[\$ _____] Serial Bonds*

<u>Maturity (July 1)</u>	<u>Principal Amount</u>	<u>Interest Rate</u>	<u>Price</u>	<u>Yield</u>	<u>CUSIP[†]</u>
2022					
2023					
2024					
2025					
2026					
2027					
2028					
2029					
2030					
2031					
2032					
2033					
2034					
2035					
2036					
\$ _____	*	_____ %	Term Bond due July 1, 20____;	Yield: _____ %;	Price: _____ %; CUSIP [†] _____
\$ _____	*	_____ %	Term Bond due July 1, 20____;	Yield: _____ %;	Price: _____ %; CUSIP [†] _____

[†] CUSIP® is a registered trademark of the American Bankers Association. CUSIP data herein is provided by CUSIP Global Services, which is managed on behalf of S&P Capital I.Q., a business line of The McGraw-Hill Companies, Inc. This data is not intended to create a database and does not serve in any way as a substitute for the CUSIP Service. CUSIP data herein is provided for convenience of reference only. None of the Authority, the Borrower, the Underwriter or their respective agents take any responsibility for the accuracy of such data now or at any time in the future. The CUSIP number for a specific maturity is subject to being changed after the issuance of the Bonds as a result of various subsequent actions including, but not limited to, a refunding in whole or in part of such maturity or as a result of the procurement of secondary market portfolio insurance or other similar enhancement by investors that is applicable to all or a portion of certain maturities of the Bonds.

* Preliminary, subject to change.

NO DEALER, BROKER, SALESMAN OR OTHER PERSON HAS BEEN AUTHORIZED BY THE BOARD OR THE UNDERWRITER TO GIVE ANY INFORMATION OR TO MAKE ANY REPRESENTATIONS OTHER THAN THOSE CONTAINED IN THIS OFFICIAL STATEMENT AND, IF GIVEN OR MADE, SUCH OTHER INFORMATION OR REPRESENTATIONS MUST NOT BE RELIED UPON AS HAVING BEEN AUTHORIZED BY ANY OF THE FOREGOING. THIS OFFICIAL STATEMENT DOES NOT CONSTITUTE AN OFFER TO SELL OR THE SOLICITATION OF AN OFFER TO BUY, NOR SHALL THERE BE ANY SALE OF THE SERIES 2022 BONDS BY ANY PERSON IN ANY JURISDICTION IN WHICH IT IS UNLAWFUL FOR SUCH PERSON TO MAKE SUCH OFFER, SOLICITATION OR SALE.

THE INFORMATION SET FORTH HEREIN HAS BEEN OBTAINED FROM THE BOARD, DTC AND FROM OTHER SOURCES WHICH ARE BELIEVED TO BE RELIABLE, BUT IT IS NOT GUARANTEED AS TO ACCURACY OR COMPLETENESS AND IS NOT TO BE CONSIDERED AS A REPRESENTATION BY THE UNDERWRITER OR ITS COUNSEL. IN ACCORDANCE WITH, AND AS A PART OF, ITS RESPONSIBILITIES TO INVESTORS UNDER THE FEDERAL SECURITIES LAWS AS APPLIED TO THE FACTS AND CIRCUMSTANCES OF THIS TRANSACTION, THE UNDERWRITER HAS REVIEWED THE INFORMATION IN THIS OFFICIAL STATEMENT BUT THE UNDERWRITER DOES NOT GUARANTEE THE ACCURACY OR THE COMPLETENESS OF SUCH INFORMATION. THE INFORMATION AND EXPRESSIONS OF OPINION HEREIN ARE SUBJECT TO CHANGE WITHOUT NOTICE AND NEITHER THE DELIVERY OF THIS OFFICIAL STATEMENT NOR ANY SALE MADE HEREUNDER SHALL, UNDER ANY CIRCUMSTANCES, CREATE ANY IMPLICATION THAT THERE HAS BEEN NO CHANGE IN THE AFFAIRS OF THE BOARD, OR DTC SINCE THE DATE HEREOF. THIS OFFICIAL STATEMENT DOES NOT CONSTITUTE A CONTRACT BETWEEN THE BOARD OR THE UNDERWRITER AND ANY ONE OR MORE OF THE REGISTERED OWNERS OF THE SERIES 2022 BONDS.

THE REGISTRATION, QUALIFICATION OR EXEMPTION OF THE SERIES 2022 BONDS IN ACCORDANCE WITH THE APPLICABLE SECURITIES LAW PROVISIONS OF THE JURISDICTIONS WHEREIN THESE SECURITIES HAVE BEEN REGISTERED, QUALIFIED OR EXEMPTED DOES NOT MEAN THAT EITHER THESE JURISDICTIONS OR ANY OF THEIR AGENCIES HAVE PASSED IN ANY WAY UPON THE MERITS OR QUALIFICATIONS OF, OR RECOMMENDED THESE SECURITIES, OR THEIR OFFER OR SALE. NEITHER SUCH JURISDICTIONS NOR ANY OF THEIR AGENCIES HAVE GUARANTEED OR PASSED UPON THE SAFETY OF THE SERIES 2022 BONDS AS AN INVESTMENT, UPON THE PROBABILITY OF ANY EARNINGS THEREON, OR UPON THE ACCURACY OR ADEQUACY OF THIS OFFICIAL STATEMENT. ANY REPRESENTATION INCONSISTENT WITH THE FOREGOING IS UNLAWFUL.

IN MAKING AN INVESTMENT DECISION, INVESTORS MUST RELY ON THEIR OWN EXAMINATION OF THE BOARD AND THE TERMS OF THE OFFERING, INCLUDING THE MERITS AND RISKS INVOLVED. THESE SECURITIES HAVE NOT BEEN RECOMMENDED BY ANY FEDERAL OR STATE SECURITIES COMMISSION OR REGULATORY AUTHORITY. FURTHERMORE, THE FOREGOING AUTHORITIES HAVE NOT CONFIRMED THE ACCURACY OR DETERMINED THE ADEQUACY OF THIS DOCUMENT. ANY REPRESENTATION TO THE CONTRARY IS A CRIMINAL OFFENSE.

FOR THE PURPOSES OF RULE 15c2-12 PROMULGATED BY THE SECURITIES AND EXCHANGE COMMISSION PURSUANT TO THE SECURITIES EXCHANGE ACT OF 1934, AS AMENDED, AS OF THE DATE OF THIS PRELIMINARY OFFICIAL STATEMENT, THE BOARD DEEMED THIS PRELIMINARY OFFICIAL STATEMENT "FINAL" (AS THAT TERM IS USED IN PARAGRAPH (b)(1) OF SAID RULE 15c2-12).

THE SERIES 2022 BONDS HAVE NOT BEEN REGISTERED WITH THE SECURITIES AND EXCHANGE COMMISSION UNDER THE SECURITIES ACT OF 1933, AS AMENDED.

Cautionary Statements Regarding Forward-Looking Statements in this Official Statement

This Official Statement is marked with a dated date and speaks only as of that dated date. Readers are cautioned not to assume that any information has been updated beyond the dated date except as to any portion of the Official Statement that expressly states that it constitutes an update concerning specific recent events occurring after the dated date of the Official Statement. Any information contained in the portion of the Official Statement indicated to concern recent events speaks only as of its date. The Board expressly disclaims any duty to provide an update of any information contained in this Official Statement, except as agreed upon by said parties pursuant to the Continuing Disclosure Certificate included herein as APPENDIX F.

The information contained in this Official Statement may include forward looking statements by using forward-looking words such as "may," "will," "should," "expects," "believes," "anticipates," "estimates," "budgets" or others. The reader is cautioned that forward-looking statements are subject to a variety of uncertainties that could cause actual results to differ from the projected results. Those risks and uncertainties include general economic and business conditions, and various other factors which are beyond the control of the Board.

This Official Statement contains projections of revenues, expenditures and other matters. Because the Board cannot predict all factors that may affect future decisions, actions, events or financial circumstances, what actually happens may be different from what is included in forward-looking statements.

TABLE OF CONTENTS

INTRODUCTORY STATEMENT	1
PLAN OF FINANCE.....	5
ESTIMATED SOURCES AND USES OF FUNDS	6
THE BOARD	6
Powers	6
The LSU System.....	6
Membership.....	7
THE UNIVERSITY.....	8
General	8
University Administration.....	9
THE AUXILIARY ENTERPRISES.....	10
HISTORICAL AUXILIARY REVENUES.....	12
OUTSTANDING PARITY BONDS	13
ANNUAL DEBT SERVICE REQUIREMENTS ON OUTSTANDING PARITY BONDS AND SERIES 2022 BONDS AND BASE RENTAL ON SUBORDINATE LEASE OBLIGATIONS	14
PRO FORMA DEBT SERVICE AND BASE RENTAL COVERAGE RATIOS	16
THE SERIES 2022 BONDS	17
General	17
Provisions Applicable if Book-Entry Only System is Terminated.....	17
Redemption Provisions.....	19
SUBORDINATE LEASE OBLIGATIONS AND PAYMENT THEREOF	21
SECURITY FOR THE SERIES 2022 BONDS	24
General	24
Pledge	24
No Superior Pledge.....	25
Special and Limited Obligations	25
Rate Maintenance Covenant; Rules and Adequacy of Charges for Use of the Auxiliary Facilities	26
Approval for Fees and Tuition Increases.....	26
Deposit and Disposition of Auxiliary Revenues	26
Additional Bonds.....	27
Subordinated Debt.....	27
Funds and Accounts Created Under the Bond Resolution	27
Events of Default and Remedies	29
FUTURE FINANCING PLANS	29
BONDHOLDERS' RISKS.....	30
TAX MATTERS.....	30
General Matters	30

Market Discount; Original Issue Discount	31
Unearned Income Medicare Contribution Tax	31
Sales of Other Dispositions	32
Defeasance.....	32
Backup Withholding.....	32
Foreign Investors.....	32
Tax-Exempt Investors	33
ERISA Considerations.....	33
Changes in Federal and State Tax Law	34
 RATINGS	 34
 LEGAL MATTERS.....	 35
 LITIGATION.....	 35
 UNDERWRITING	 35
 VERIFICATION OF COMPUTATIONS	 36
 CERTIFICATION AS TO OFFICIAL STATEMENT	 36
 CONTINUING DISCLOSURE.....	 36
 MISCELLANEOUS	 38
 BOOK-ENTRY ONLY SYSTEM.....	 1
 APPENDIX A - DEMOGRAPHIC AND SUMMARY FINANCIAL INFORMATION RELATED TO THE UNIVERSITY	
APPENDIX B - FINANCIAL REPORT OF THE LSU SYSTEM FOR THE YEAR ENDED JUNE 30, 2020	
APPENDIX C - PROPOSED FORM OF OPINION OF BOND COUNSEL	
APPENDIX D - DEFINITIONS OF CERTAIN TERMS	
APPENDIX E - SUMMARY OF CERTAIN PROVISIONS OF THE BOND RESOLUTION	
APPENDIX F - FORM OF CONTINUING DISCLOSURE CERTIFICATE	
APPENDIX G-1 - SERIES 2012 REFUNDED BONDS	
APPENDIX G-2 - SERIES 2013 REFUNDED BONDS	
APPENDIX G-3 - SERIES 2014 REFUNDED BONDS	
APPENDIX G-4 - SERIES 2016A REFUNDED BONDS	
APPENDIX H - BOOK-ENTRY ONLY SYSTEM	

OFFICIAL STATEMENT

Relating To

[\$_____]*

BOARD OF SUPERVISORS OF LOUISIANA STATE UNIVERSITY AND AGRICULTURAL AND MECHANICAL COLLEGE TAXABLE AUXILIARY REVENUE REFUNDING BONDS SERIES 2022

INTRODUCTORY STATEMENT

General

The purpose of this Official Statement (including the Cover Page and the Appendices) is to provide certain information concerning the sale by the Board of Supervisors of Louisiana State University and Agricultural and Mechanical College (the "*Board*") of its Taxable Auxiliary Revenue Refunding Bonds, Series 2022, in an aggregate principal amount of [\$_____]* (the "*Series 2022 Bonds*"). The Board is a public constitutional corporation created pursuant to the provisions of Article VIII, Section 7(A) of the Constitution of the State of Louisiana of 1974. Pursuant to the provisions of Sections 2181 through 2193 and 3351(A)(4) of Title 17 of the Louisiana Revised Statutes of 1950, as amended, Chapter 14-A of Title 39 of the Louisiana Revised Statutes of 1950, as amended (the "*Refunding Act*"), and Article VII, Section 6(C) of the Constitution of the State of Louisiana of 1974, as amended (collectively, including the Refunding Act, the "*Act*"), the Board is authorized to borrow money and to issue bonds and to pledge fees, rates, rentals, charges or other income and revenues to guarantee payment thereof. See "**THE BOARD**" and "**THE SERIES 2022 BONDS**" herein.

Use of Proceeds of Series 2022 Bonds

The proceeds of the Series 2022 Bonds will be used by the Board, together with other available funds, for the purpose of (i) Auxiliary Revenue Refunding Bonds, Series 2012 (the "*Series 2012 Refunded Bonds*"), (ii) Auxiliary Revenue Refunding Bonds, Series 2013 (the "*Series 2013 Refunded Bonds*"), (iii) Auxiliary Revenue Refunding Bonds, Series 2014 (the "*Series 2014 Refunded Bonds*"), (iv) Auxiliary Revenue Refunding Bonds, Series 2016A (the "*Series 2016A Refunded Bonds*"), and, together with the Series 2012 Refunded Bonds, the Series 2013 Refunded Bonds and the 2014 Refunded Bonds, the "*Refunded Bonds*") and (ii) paying the costs of issuance of the Series 2022 Bonds. See "**ESTIMATED SOURCES AND USES OF FUNDS**" and "**PLAN OF FINANCE**" herein.

On June 17, 1994, the Board adopted the General Bond Resolution (as supplemented and/or amended from time to time, the "*General Bond Resolution*") to provide for certain matters relating to revenue bonds issued or to be issued from time to time in one or more series and in such principal amounts as is necessary to provide funds for capital improvements to and on behalf of the University's Auxiliary Enterprises, refund obligations of the Board or for any other purpose as may be permitted by the Act.

The Series 2012 Refunded Bonds were issued pursuant to the General Bond Resolution and the Fifteenth Supplemental Resolution approved by the Board on June 8, 2012 and executed August 7, 2012 (collectively, the "*2012 Bond Resolution*"). The Series 2013 Refunded Bonds were issued pursuant to the General Bond Resolution and the Sixteenth Supplemental Resolution adopted by the Board on March 8, 2013 and executed on April 25, 2013 (collectively, the "*2013 Bond Resolution*"). The Series 2014 Refunded Bonds were issued pursuant to the General Bond Resolution and the Seventeenth Supplemental Resolution (collectively, the "*2014 Bond Resolution*"). The Series 2016A Refunded Bonds were issued pursuant to the

* Preliminary, subject to change.

General Bond Resolution and the Eighteenth Supplemental Resolution approved by the Board on October 21, 2016 and executed November 15, 2016 (collectively, the "2016A Bond Resolution" and, together with the 2012 Bond Resolution, the 2013 Bond Resolution and the 2014 Bond Resolution, the "Refunded Bonds Resolution").

The trustee, paying agent and escrow trustee for the Refunded Bonds is The Bank of New York Mellon Trust Company, N.A. (the "Trustee," the "Paying Agent" and the "Escrow Trustee," respectively).

The Bond Resolution and Security for the Series 2022 Bonds

The Series 2022 Bonds will be issued pursuant to the General Bond Resolution, as supplemented by the Twentieth Supplemental Resolution approved by the Board on October 29, 2021, and to be executed and effective on the date of delivery of the Series 2022 Bonds (the "Twentieth Supplemental Resolution" and, together with the General Bond Resolution, the "Bond Resolution"). Pursuant to the Bond Resolution, The Bank of New York Mellon Trust Company, N.A., is appointed as the trustee and paying agent for the Series 2022 Bonds (the "Trustee" and "Paying Agent").

Pursuant to the Bond Resolution, the Series 2022 Bonds are payable from and secured by a pledge (on a senior lien basis as to Base Rental on the Subordinate Lease Obligations, as defined herein) of the Auxiliary Revenues of the University. "Auxiliary Revenues," as defined in the General Bond Resolution, means (i) (a) the gross amount of all funds, monies or revenues held by the University and any earnings thereon derived or to be derived by Auxiliary Enterprises from self-generated revenues from all fees, rates, rentals, charges or other receipts or income received from students or the public at large in connection with any undertaking, utilization, or operation of Auxiliary Enterprises or Auxiliary Facilities, including operation or management thereof by private entities on behalf of the Auxiliary Enterprises, prior to the payment of Base Rental on the Subordinate Lease Obligations and Current Expenses (as defined in the General Bond Resolution), (b) Lab School Revenues, provided, however, that the Lab School Revenues shall constitute Auxiliary Revenues only for so long as the Series 2002 Bonds and the Series 2005 Bonds are outstanding, and (c) Recreational Sports Fee Revenues, provided, however, that Recreational Sports Fee Revenues shall constitute Auxiliary Revenues only for so long as the Series 2002 Bonds are outstanding; and (ii) all Funds and Accounts held pursuant to the General Bond Resolution, as supplemented, pertaining to a particular Series of Bonds except any fund created to hold monies pending rebate to the United States or for payment of the costs of issuance of Bonds. See the following paragraph and "**SECURITY FOR THE SERIES 2022 BONDS**" herein for a description of the pledge of Auxiliary Revenues pursuant to the Bond Resolution as well as a description of the duration of certain elements of such pledge.

In the Twentieth Supplemental Resolution, the Board (a) confirms the pledge of and does thereby pledge the Lab School Revenues, as Auxiliary Revenues, as security for the payment of all Bonds Outstanding under the General Bond Resolution and any Supplemental Resolutions until the later of (i) July 1, 2034 and (ii) the maturity date of any Bonds issued to finance or refinance projects for the Lab School, and (b) therein additionally confirms the pledge of, and does thereby pledge, the Recreational Sports Fee Revenues as Auxiliary Revenues as security for the payment of all Bonds Outstanding under the General Bond Resolution and any Supplemental Resolutions until the later of (i) July 1, 2043, and (ii) the maturity date of any Bonds issued to finance or refinance projects for the Student Recreational Sports Complex.

"**Lab School Revenues**" is defined in the Bond Resolution as "the revenues derived by the Lab School from a \$500 tuition increase effective with the 2000-01 school year and a \$265 tuition increase effective with the 2001-02 school year in accordance with House Bill No. 1920 of the 1999 Regular Session of the Louisiana Legislature and with a resolution adopted by the Board on July 16, 1999."

"Recreational Sports Fee Revenues" is defined in the Bond Resolution as "(a) the \$15.00 per fall and spring semesters increase and \$5.00 per summer semester increase in the self-assessed student recreational sports fee authorized by the Board by its resolution adopted May 31, 2002 and (b) (i) the \$20.00 per summer semester increase beginning summer semester of the 2012-13 academic year, (ii) the \$45.00 per fall and spring semesters increase and \$20.00 per summer semester increase beginning fall semester of the 2013-14 academic year, (iii) the \$45.00 per fall and spring semesters increase and \$20.00 per summer semester increase to be imposed beginning fall semester of the 2014-15 academic year and (iv) the \$45.00 per fall and spring semesters increase to be imposed beginning fall semester of the 2015-16 academic year in the student recreational sports fee authorized by the Board by its resolution adopted February 1, 2013, such that the total summer fee in 2015 and thereafter will be \$85 and the total fall and spring semester fee in 2015-2016 and thereafter will be \$200."

AUXILIARY REVENUES DO NOT INCLUDE FUNDS APPROPRIATED TO THE BOARD BY THE LEGISLATURE OF THE STATE OF LOUISIANA (THE "*STATE*") FROM TIME TO TIME. SEE "**THE AUXILIARY ENTERPRISES**" HEREIN.

THE PAYMENT OF THE PRINCIPAL OF AND INTEREST ON THE SERIES 2022 BONDS IS A SPECIAL AND LIMITED OBLIGATION OF THE BOARD PAYABLE SOLELY FROM THE AUXILIARY REVENUES.

The Board may issue Additional Bonds on a parity with the Series 2022 Bonds and the Outstanding Parity Bonds (defined herein), as well as incur Subordinated Debt, to the extent and under the conditions set forth in the General Bond Resolution. See "**SECURITY FOR THE SERIES 2022 BONDS - Additional Bonds**", "**- Subordinated Debt**" and "**FUTURE FINANCING PLANS**" herein.

Subordinate Lease Obligations

To meet the need for additional high quality student housing on the main campus of the University, the University and LSU Property Foundation (as defined herein) partnered with Provident Flagship (as defined herein) for the development and redevelopment of housing and other facilities. The Board is obligated under leases entered into in connection with each phase of such development and redevelopment to make rent payments solely from the Auxiliary Revenues of the University, subordinate and junior in all respects to the payment of debt service on, and the pledge of the Auxiliary Revenues to, the Outstanding Parity Bonds and the Series 2022 Bonds. See "**SUBORDINATE LEASE OBLIGATIONS AND PAYMENT THEREOF**" herein.

Redemption of Series 2022 Bonds

THE SERIES 2022 BONDS ARE SUBJECT TO EXTRAORDINARY OPTIONAL, OPTIONAL AND MANDATORY SINKING FUND REDEMPTION PRIOR TO MATURITY AS MORE FULLY DESCRIBED HEREIN UNDER "**THE SERIES 2022 BONDS - Redemption Provisions.**"

Limitation of Liability

THE SERIES 2022 BONDS ARE SPECIAL AND LIMITED OBLIGATIONS OF THE BOARD PAYABLE SOLELY FROM AUXILIARY REVENUES, THE LAB SCHOOL REVENUES AND THE RECREATIONAL SPORTS FEE REVENUES; PROVIDED THAT (a) THE PLEDGE OF THE LAB SCHOOL REVENUES WILL LAPSE ON THE LATER OF (i) JULY 1, 2034 AND (ii) THE MATURITY DATE OF ANY BONDS ISSUED TO FINANCE OR REFINANCE PROJECTS FOR THE LAB SCHOOL AND (b) THE PLEDGE OF RECREATIONAL SPORTS FEE REVENUES WILL LAPSE ON THE LATER OF (i) JULY 1, 2043 AND (ii) THE MATURITY DATE OF ANY BONDS ISSUED TO FINANCE OR REFINANCE PROJECTS FOR THE STUDENT RECREATIONAL SPORTS

COMPLEX. THE SERIES 2022 BONDS SHALL NOT CONSTITUTE AN INDEBTEDNESS OR PLEDGE OF THE GENERAL CREDIT OF THE UNIVERSITY, THE BOARD, THE STATE OR ANY POLITICAL SUBDIVISION THEREOF WITHIN THE MEANING OF ANY CONSTITUTIONAL OR STATUTORY LIMITATION OF INDEBTEDNESS AND SHALL CONTAIN A RECITAL TO THAT EFFECT. NEITHER THE STATE NOR ANY AGENCY OR POLITICAL SUBDIVISION THEREOF, OTHER THAN THE BOARD, SHALL BE OBLIGATED TO PAY THE PRINCIPAL OF THE SERIES 2022 BONDS OR THE INTEREST THEREON, AND THE SERIES 2022 BONDS SHALL NOT BE DEEMED TO CONSTITUTE A DEBT OR LIABILITY OF THE STATE OR ANY AGENCY OR POLITICAL SUBDIVISION OR AGENCY THEREOF, OTHER THAN THE BOARD.

THE AUXILIARY REVENUES, THE LAB SCHOOL REVENUES AND THE RECREATIONAL SPORTS FEE REVENUES ARE PLEDGED TO THE PAYMENT OF THE SERIES 2022 BONDS ON A PARITY WITH THE BOARD'S OUTSTANDING PARITY BONDS HERETOFORE AND HEREAFTER ISSUED (INCLUDING THE SERIES 2022 BONDS); PROVIDED THAT (a) THE LAB SCHOOL REVENUES SHALL BE SO PLEDGED ONLY UNTIL THE LATER OF (i) JULY 1, 2034 AND (ii) THE MATURITY DATE OF ANY BONDS ISSUED TO FINANCE OR REFINANCE PROJECTS FOR THE LAB SCHOOL, AND (b) THE RECREATIONAL SPORTS FEE REVENUES SHALL BE SO PLEDGED ONLY UNTIL THE LATER OF (i) JULY 1, 2043 AND (ii) THE MATURITY DATE OF ANY BONDS ISSUED TO FINANCE OR REFINANCE PROJECTS FOR THE STUDENT RECREATIONAL SPORTS COMPLEX. SEE "**OUTSTANDING PARITY BONDS**" AND "**SECURITY FOR THE SERIES 2022 BONDS - Additional Bonds**" HEREIN.

For purposes of the Bond Resolution and this Official Statement, references therein and herein to the term "Auxiliary Revenues" shall be deemed to include Lab School Revenues and Recreational Sports Fee Revenues with the caveat that the pledge of such revenues is limited as set forth in the foregoing paragraphs.

For financial information regarding the University, see "**APPENDIX A - DEMOGRAPHIC AND SUMMARY FINANCIAL INFORMATION RELATED TO THE UNIVERSITY**" and "**APPENDIX B - FINANCIAL REPORT OF THE LSU SYSTEM FOR THE YEAR ENDED JUNE 30, 2020.**"

Descriptions of Documents; Defined Terms

This Official Statement contains descriptions of, among other matters, the Series 2022 Bonds, the Board, the University, the Bond Resolution, the Continuing Disclosure Certificate, the Escrow Agreement (as hereinafter defined) and the Bond Purchase Agreement. Such descriptions and information do not purport to be comprehensive or definitive. All references herein to the Bond Resolution are qualified in their entirety by reference to the text of the General Bond Resolution and the Twentieth Supplemental Resolution, and all references herein to the Series 2022 Bonds are qualified in their entirety by reference to the form thereof included in the Twentieth Supplemental Resolution. Until the issuance and delivery of the Series 2022 Bonds, copies of the General Bond Resolution and draft copies of the Twentieth Supplemental Resolution and other documents described herein may be obtained from Raymond James & Associates, Inc., 909 Poydras Street, Suite 1300, New Orleans, Louisiana 70112. After delivery of the Series 2022 Bonds, copies of documents in connection with the Series 2022 Bonds will be available for inspection at the corporate trust office of the Trustee located at 10161 Centurion Parkway, Jacksonville, Florida 32256. See "**APPENDIX D - DEFINITIONS OF CERTAIN TERMS**" and "**APPENDIX E - SUMMARY OF CERTAIN PROVISIONS OF THE BOND RESOLUTION.**"

All capitalized terms used, and not otherwise defined, in this Official Statement have the meanings assigned to them in "**APPENDIX D - DEFINITIONS OF CERTAIN TERMS.**"

PLAN OF FINANCE*

The Board will use approximately [\$_____]* of the proceeds of the Series 2022 Bonds, together with available funds of the Board in the approximate amount of [\$_____]* to refund the Refunded Bonds. The remainder of the proceeds of the Series 2022 Bonds will be used to pay the costs of issuance thereof. The defeasance and advance refunding of the Refunded Bonds is being undertaken for the purpose of lowering the total overall cost of debt service to the Board.

Pursuant to the Bond Resolution, concurrently with the delivery of the Series 2022 Bonds, the Board will irrevocably deposit approximately (i) \$_____ of proceeds of the Series 2022 Bonds and available funds of the Board in the approximate amount of \$_____ to the Escrow Fund (the "*Escrow Fund*") created under the Escrow Agreement (Series 2012, Series 2013, Series 2014 and 2016A) dated the date of issuance of the Series 2022 Bonds (the "*Escrow Agreement*"), between the Board and the Escrow Trustee, for the purpose of refunding and/or defeasing the Refunded Bonds.

The 2012 Bond Resolution, the 2013 Bond Resolution, the 2014 Bond Resolution, the 2016A Bond Resolution and the Escrow Agreement require the Escrow Trustee to invest amounts deposited in the Escrow Fund in Defeasance Obligations described therein to effect a defeasance of the Refunded Bonds. The Escrow Fund, together with investment earnings thereon, shall be sufficient to pay (i) the principal and interest on the Series 2012 Refunded Bonds through their redemption on July 1, 2022, (ii) the principal and interest on the Series 2013 Refunded Bonds through their redemption on July 1, 2023, (iii) the principal and interest on the Series 2014 Refunded Bonds through their redemption on July 1, 2024, and (iv) the principal and interest on the Series 2016A Refunded Bonds through their redemption on July 1, 2026, as verified by Causey Demgen & Moore P.C. See "**VERIFICATION OF COMPUTATIONS**" and "**ESTIMATED SOURCES AND USES OF FUNDS**" herein, and "**APPENDIX G-1 – SERIES 2012 REFUNDED BONDS**," "**APPENDIX G-2 – SERIES 2013 REFUNDED BONDS**," "**APPENDIX G-3 – SERIES 2014 REFUNDED BONDS**" and "**APPENDIX G-4 – SERIES 2016A REFUNDED BONDS**" attached hereto.

Upon the deposit of such moneys into the Escrow Fund, in the opinion of Bond Counsel, the Refunded Bonds shall be deemed to be paid and shall no longer be deemed to be outstanding, and the holders of the Refunded Bonds shall be entitled to payment solely out of the moneys or securities deposited in the Escrow Fund.

[Remainder of Page Intentionally Left Blank]

* Preliminary, subject to change.

ESTIMATED SOURCES AND USES OF FUNDS*

The following table sets forth the estimated sources and uses of funds in connection with the issuance of the Series 2022 Bonds and the refunding and/or defeasance of the Refunded Bonds:

Sources

Principal Amount of Series 2022 Bonds	
Available Funds of the Board ⁽¹⁾	_____
Total	=====

Uses

Deposit to Series 2012 Escrow Fund	
Deposit to Series 2013 Escrow Fund	
Deposit to Series 2014 Escrow Fund	
Deposit to Series 2016A Escrow Fund	
Costs of Issuance ⁽²⁾	_____
Total	=====

⁽¹⁾ Consists of funds released under the Refunded Bonds Resolution from the Debt Service Reserve Fund and the Bond Fund.

⁽²⁾ Includes Underwriter's discount, legal fees and expenses and other costs of issuance, the payment of the majority of which is contingent upon the issuance of the Series 2022 Bonds.

THE BOARD

Powers

The Board was created by Article VIII, Section 6 of the 1974 Constitution as a body corporate. The Board manages and supervises seven institutions of higher education (the "LSU System"), one of which is the University, the flagship campus of the State located in Baton Rouge, Louisiana. See "THE UNIVERSITY" herein.

On October 29, 2021, the Board adopted a resolution authorizing the issuance of the Bonds and adopted the Twentieth Supplemental Resolution.

The LSU System

The LSU System is composed of a group of publicly owned institutions of higher education that are under the supervision and management of the Board, enrolling approximately [_____ students in Fall 2021]. The institutions supervised by the Board include:

1. Louisiana State University and Agricultural and Mechanical College (which includes the Paul M. Hebert Law Center), located in Baton Rouge, Louisiana;
2. LSU Agricultural Center (including the Louisiana Agricultural Experiment Station and Louisiana Cooperative Extension Service), with headquarters in Baton Rouge, Louisiana;
3. LSU in Shreveport, Louisiana;

* Preliminary, subject to change.

4. LSU at Alexandria, Louisiana;
5. LSU at Eunice, Louisiana;
6. LSU Health Sciences Center-New Orleans, composed of the Schools of Medicine, Graduate Studies, Dentistry, Nursing, Allied Health Professions and Public Health, located in New Orleans, Louisiana; and
7. LSU Health Sciences Center-Shreveport, composed of Schools of Medicine, Graduate Studies and Allied Health Professions.

The LSU System also owns and manages the Pennington Biomedical Research Center, located in Baton Rouge, Louisiana (provided that the physical plant thereof is owned by the Pennington Medical Foundation). Through its Health Care Services Division, the LSU System owns and administers, either directly or through public-private partnerships, each of the hospitals comprising the State's public hospital system, including University Medical Center of Louisiana at New Orleans, E.A. Conway Medical Center, Lallie Kemp Regional Medical Center, W.O. Moss Regional Medical Center, Leonard J. Chabert Medical Center, University Medical Center and Our Lady of the Angels Hospital (formerly the Washington/St. Tammany Regional Medical Center d/b/a Bogalusa Community Medical Center).

For over 150 years, the institutions in the LSU System have served the people of Louisiana, the region, the nation, and the world through extensive, multipurpose programs encompassing instruction, research and public service. The LSU System offers undergraduate, graduate and professional educational programs for outstanding students from the State, the nation and other countries. The LSU System's nationally and internationally recognized efforts in a broad range of research fields create new knowledge and promote economic development. The LSU System's libraries and museums preserve the rich cultural heritage of the State, and scholars and artists at the LSU System contribute to the literature, history, science, technology and arts of the State's culturally diverse community.

Membership

Mr. Rémy Voisin Starns (Chair). Mr. Starns was appointed to the Board on June 5, 2018, and his term representing the First Congressional District will expire on June 1, 2024. Mr. Starns is the founder of The Starns Law Firm.

Ms. Valencia Sarpy Jones (Chair-elect). Ms. Jones was appointed to the Board on August 29, 2016, and her term representing the Fourth Congressional District will expire June 1, 2022. Ms. Jones is a financial services professional with New York Life Insurance Company and NYLIFE Securities.

Mr. Robert S. Dampf (Past Chair). Mr. Dampf was appointed to the Board on June 5, 2018, and his term representing the Sixth Congressional District will expire June 1, 2024. Mr. Dampf is a partner in Perry Dampf Dispute Solutions.

Ms. Monica Aguilera (Student Member). Ms. Aguilera is the Student Body President at LSU Alexandria and was elected by the LSU Council of Student Body Presidents to represent the students. Her term of service will expire May 31, 2022.

Laura Lipsey Aronson. Ms. Aronson was appointed to the Board on [_____], and her current term as a member-at-large will expire June 1, 2026. Ms. Aronson is the Chairwoman & Chief Executive Officer of Lipsey's and Haspel.

Mr. Glenn J. Armentor. Mr. Armentor was appointed to the Board on June 2, 2016, and his term representing the Third Congressional District will expire June 1, 2022. Mr. Armentor is a General Partner in the Glenn Armentor Law Corporation.

Mr. Jack A. "Jay" Blossman, Jr. Mr. Blossman was appointed to the Board on June 5, 2018, and his term representing the First Congressional District will expire on June 1, 2024. Mr. Blossman is an attorney.

Mr. B. Wayne Brown. Mr. Brown was appointed to the Board on June 5, 2018, and his term representing the Fourth Congressional District will expire June 1, 2024. Mr. Brown is the founder and Chairman of the Board of Directors of Brown Builders, Inc.

Mr. Lee Mallett. Mr. Mallett was appointed to the Board on July 12, 2012, and his term as a member-at-large will expire June 1, 2024. Mr. Mallett is Owner of Mallett Buildings, and is the Owner and Operator of the Academy of Training Skills.

Mr. Patrick C. Morrow. Mr. Morrow was appointed to the Board on [_____], and his current term representing the Fifth Congressional District will expire June 1, 2026. Mr. Morrow is the founder of Morrow, Morrow, Ryan, Bassett & Haik Law Firm.

Mr. Raymond R. "Randy" Morris. Mr. Morris was appointed to the Board on [_____], and his current term representing the Fifth Congressional District will expire June 1, 2026. He is the owner of West Carroll Health Systems.

Mr. Collis B. Temple, Jr. Mr. Temple was appointed to the Board on [_____], and his current term representing the Sixth Congressional District will expire June 1, 2026. Mr. Temple is the Chief Executive Officer of CT Construction and the Harmony Center.

Ms. Mary L. Werner. Ms. Werner was appointed to the Board on June 12, 2017, and her term representing the Third Congressional District will expire on June 1, 2024. Ms. Werner is director and Vice President of The North American Land Company, LLC and The Sweet Lake Land and Oil Company, LLC.

Mr. James W. Williams. Mr. Williams was appointed to the Board on June 2, 2016, and his term representing the Second Congressional District will expire June 1, 2022. He is a partner in the law firm of Chehardy Sherman Williams.

Mr. Jimmie M. Woods. Mr. Woods was appointed to the Board on June 5, 2018, and his term representing the First Congressional District will expire on June 1, 2024. Mr. Woods is the Chief Executive Officer of Metro Service Group.

Mr. Richard E. Zuschlag. Mr. Zuschlag was appointed to the Board on [_____], and his current term as a member-at-large will expire June 1, 2022. He is the Chairman and Chief Executive Officer of Acadian Companies.

THE UNIVERSITY

General

Since opening its doors in 1860, the University has served the people of Louisiana, the region, the nation and the world through extensive, multipurpose programs encompassing instruction, research, and public service. The University offers undergraduate, graduate and professional educational programs for outstanding students from the State, the nation, and other countries. The University's nationally and

internationally recognized efforts in a broad range of research fields create new knowledge and promote economic development. The University's libraries and museums preserve the rich cultural heritage of the State, and scholars and artists at the University contribute to the literature, history, science, technology and arts of the State's culturally diverse community. As the premier university of the State, the mission of the University is the generation, preservation, dissemination, and application of knowledge and cultivation of the arts for the benefit of the people of the State, the nation, and the global community. LSU is designated as a Carnegie Foundation Research University Very High Research Activity (the highest category), and is also one of the limited number of universities nationwide holding Land, Sea and Space Grant Institution status.

The University was founded in 1853 by the General Assembly of Louisiana as the Louisiana State Seminary of Learning and Military Academy near Pineville, Louisiana. The institution opened January 2, 1860. When the Civil War began, the school's first superintendent, William Tecumseh Sherman, resigned to assume a command in the Union Army.

Fire demolished the Seminary in 1869, and the school was moved to Baton Rouge. In 1870, the Seminary was renamed Louisiana State University. In 1874, under the United States Morrill Act, the Louisiana State Agricultural and Mechanical College was established in New Orleans. The two institutions were merged by the Legislature in 1877 to become Louisiana State University and Agricultural and Mechanical College.

Construction of the present campus in Baton Rouge began in 1922, and the first classes were held in 1926. LSU experienced major growth in the 1930s and 1940s, expanding its student body, curricula and services. During the 1960s, the University began to place increasing emphasis on research.

The University is located on more than 2,000 acres in the southern part of Baton Rouge, Louisiana, the capital of the State, and is bordered on the west by the Mississippi River. The University's more than 250 principal buildings are grouped on a 650-acre plateau that constitutes the main part of the campus.

Demographic and summary financial information related to the University is attached hereto as **APPENDIX A**, and the Financial Report of the LSU System for the year ended June 30, 2020, is attached hereto as **APPENDIX B**.

University Administration

Dr. William F. Tate, IV (*President of Louisiana State University*): On [May 21, 2021], William F. Tate, IV assumed his official duties as President of Louisiana State University. Dr. Tate received his Ph.D. in mathematics education from the University of Maryland, Master of Arts in Teaching from the University of Texas at Dallas, Master of Psychiatric Epidemiology from Washington University School of Medicine, and Bachelor of Science in economics from Northern Illinois University. Dr. Tate served as Executive Vice President for Academic Affairs and Provost at the University of South Carolina since July 2020. Prior to that, he served as dean of the Graduate School & Vice Provost for Graduate Education at Washington University in St. Louis from 2002 to 2020. Dr. Tate also spent time at Texas Christian University and University of Wisconsin-Madison

Ms. Donna K. Torres, CPA (*Interim Executive Vice President for Finance and Administration/CFO*): Ms. Torres serves as the Interim Executive Vice President for Finance and Administration/CFO, having been appointed on October 16, 2020. Ms. Torres previously held the position of Associate Vice President for Accounting Services at the University. Her responsibilities include executive-level planning, implementation and assessment of financial and administrative strategies, policies and procedures for the University. Ms. Torres serves as the chief financial officer and is the principal advisor to the President and the Board on all fiscal and administrative matters. Ms. Torres holds Bachelor of

Science in Accounting and Master of Accounting degrees from the University. She is a licensed Certified Public Accountant and a member of LCPA and AICPA. She joined LSU in July 1991 as the Payroll Director. Prior to her employment with the University, Ms. Torres was Vice President and Controller for an insurance administrator and worked in public accounting.

Ms. Elahe Russell (*Interim Associate Vice President for Accounting Services*): Ms. Russell serves as Interim Associate Vice President for Accounting Services. Her area of responsibility is Accounting Services, which performs the day-to-day financial activities, the accounting, reporting and record keeping functions for the University, the LSU Agricultural Center, LSU at Alexandria, LSU at Eunice, LSU in Shreveport and the Pennington Biomedical Research Center. The divisions included in Accounting Services are Payroll, Accounts Payable & Travel, Bursar Operations, Sponsored Program Accounting and Financial Accounting and Reporting. Ms. Russell holds a Bachelor of Science in Accounting and Master of Science in Accounting from the University. Ms. Russell has served in various positions within Accounting Services during her career at the University including Director of Financial Accounting & Reporting, Interim Bursar, and Associate Director of Sponsored Program Accounting. Prior to her career at the University, Ms. Russell was a Senior Accountant for a private real estate company.

Mr. Tony S. Lombardo, P.E. (*Associate Vice President for Facility and Property Oversight*): Mr. Lombardo serves as Associate Vice President for Facility and Property Oversight. His areas of responsibility are the capital planning process and facilities related board items for the University campus. Mr. Lombardo functions as an advisor to senior leadership on facility optimization, financial impact and facility policy that directly relates to the mission. He also serves as the facilities officer for the University campus, responsible for the oversight of maintenance, facility operations, utility production and acquisition, construction and design. He is a licensed professional engineer in the State of Louisiana. Prior to his 17 years with the University, Mr. Lombardo conducted environmental research for the United States Environmental Protection Agency as a consulting professional. Mr. Lombardo received his bachelor's degree in engineering from the University in 1990 while concurrently acting as owner and operator of a small information technology services company.

Mr. Danny Mahaffey (*Assistant Vice President and University Architect*): Mr. Mahaffey is the Assistant Vice President and University Architect for the University. He holds a Bachelor of Architecture degree from the University and is a registered architect. Mr. Mahaffey's area of responsibility is to oversee the capital outlay process and other facility related activities that are submitted to the Board. He previously was in private practice of architecture and was a facility director for a health care system.

THE AUXILIARY ENTERPRISES

There exist at the University Auxiliary Enterprises under the control, operation or supervision of the Board, which are operated essentially as self-supporting enterprises designed to generate revenues sufficient to maintain their operation. In certain years some Auxiliary Enterprises have produced negative cash flows; however, it is the policy of the Board that each Auxiliary Enterprise is operated essentially as a self-supporting entity. Fees, rates, rentals, charges or other receipts or income constituting a major part of the Auxiliary Revenues are generated by these Auxiliary Enterprises and pledged pursuant to the Bond Resolution, are not subject to appropriation by the Legislature and are held in Board accounts outside the State Treasury. The funds and accounts of these Auxiliary Enterprises are, however, audited by the State Legislative Auditor. The Board has the power to restrict the self-generated revenues of Auxiliary Enterprises which are pledged, on a senior lien basis, to the payment of the Series 2022 Bonds issued pursuant to the Bond Resolution.

Auxiliary Facilities consist of the buildings, land, equipment and other properties under the control, operation or supervision of the following Auxiliary Enterprises of the University as the same may be modified from time to time: (1) Athletics, (2) Auxiliary Services, (3) Golf Course, (4) Lab School

Cafeteria, (5) LSU Union, (6) Parking and Transportation Services, (7) Residential Life, (8) Student Health Center, (9) Student Media, and (10) University Stores, provided that in the event Auxiliary Revenue producing activities or any portion of any such Auxiliary Enterprise are transferred to another University Enterprise, the portion of such University Enterprise used for such activity shall be deemed to be an Auxiliary Facility under the General Bond Resolution and Auxiliary Facilities as defined thereby may be modified as set forth therein.

The Auxiliary Revenues of the University pledged to the payment of Series 2022 Bonds are (i) (a) the gross amount of all funds, monies or revenues held by the University and any earnings thereon derived or to be derived by Auxiliary Enterprises from self-generated revenues from all fees, rates, rentals, charges or other receipts or income received from students or the public at large in connection with any undertaking, utilization, or operation of Auxiliary Enterprises or Auxiliary Facilities, including operation or management thereof by private entities on behalf of the Auxiliary Enterprises, prior to the payment of Subordinated Lease Obligations and Current Expenses, (b) Lab School Revenues, and (c) Recreational Sports Fee Revenues, provided, however, that (i) the Lab School Revenues shall be so pledged only until the later of July 1, 2034 and the maturity date of any bonds issued to finance or refinance projects for the Lab School, (ii) the Recreational Sports Fee Revenues shall be so pledged only until the later of July 1, 2043 and the maturity date of any bonds issued to finance or refinance projects for the Student Recreational Sports Complex; and (iii) all Funds and Accounts held pursuant to the General Bond Resolution, as supplemented, pertaining to a particular Series of Bonds except any fund created to hold monies pending rebate to the United States or for payment of the costs of issuance of Bonds.

In the Twentieth Supplemental Resolution, the Board (a) confirms the pledge of and does thereby pledge the Lab School Revenues and Recreational Sports Fee Revenues, as Auxiliary Revenues, as security for the payment of all Bonds Outstanding under the General Bond Resolution and any Supplemental Resolutions until the later of (i) July 1, 2034, and (ii) the maturity date of any Bonds issued to finance or refinance projects for the Lab School, and (b) therein additionally confirms the pledge of, and does thereby pledge, the Recreational Sports Fee Revenues as Auxiliary Revenues as security for the payment of all Bonds Outstanding under the General Bond Resolution and any Supplemental Resolutions until the later of (i) July 1, 2043, and (ii) the maturity date of any Bonds issued to finance or refinance projects for the Student Recreational Sports Complex.

Auxiliary Revenues do not include funds appropriated to the Board by the Legislature of the State from time to time.

The obligation of the Board to pay Debt Service Requirements on the Bonds and on the Outstanding Parity Bonds from Auxiliary Revenues shall be superior to any other claim on such funds, including Base Rental on the Subordinate Lease Obligations.

See "**OUTSTANDING PARITY BONDS**," "**HISTORICAL AUXILIARY REVENUES**," "**ANNUAL DEBT SERVICE REQUIREMENTS ON OUTSTANDING PARITY BONDS AND SERIES 2022 BONDS AND BASE RENTAL ON SUBORDINATE LEASE OBLIGATIONS**," "**PRO FORMA DEBT SERVICE AND BASE RENTAL COVERAGE RATIOS**," and "**SUBORDINATE LEASE OBLIGATIONS AND PAYMENT THEREOF**" herein and "**APPENDIX A – DEMOGRAPHIC AND SUMMARY FINANCIAL INFORMATION RELATED TO THE UNIVERSITY**."

HISTORICAL AUXILIARY REVENUES

The following table shows the total Auxiliary Revenues and the relative contribution ⁽¹⁾ of each Auxiliary Enterprise or other fee revenue that constitutes Auxiliary Revenues for fiscal years 2015-2016 to 2019-2020:

	<u>FY 2015-2016</u>		<u>FY 2016-2017</u>		<u>FY 2017-2018</u>		<u>FY 2018-2019</u>		<u>FY 2019-2020</u>	
	Amount	% Total	Amount	% Total	Amount	% Total	Amount	% Total	Amount	% Total
Athletics	130,855,359	56.0	134,459,371	58.0	132,896,967	58.1	139,890,023	55.8	140,695,525	55.3
LSU Union	10,349,921	4.4	10,094,550	4.4	9,793,490	4.3	9,642,855	3.8	9,166,103	3.6
Residential Life	42,209,672	18.1	40,913,517	17.7	39,401,030	17.2	54,331,080	21.7	60,372,522	23.7
University Stores	6,595,116	2.8	5,040,615	2.2	5,443,512	2.4	5,474,879	2.2	4,433,924	1.7
Parking and Transportation Services	13,056,191	5.6	12,802,673	5.5	12,550,051	5.5	12,328,093	4.9	11,212,922	4.4
Student Media	1,354,346	0.6	1,245,958	0.5	1,163,886	0.5	1,230,396	0.5	1,183,273	0.5
University Auxiliary Services	5,676,701	2.4	5,342,977	2.3	5,689,723	2.5	5,770,808	2.3	5,058,067	2.0
Lab School Cafeteria	432,121	0.2	422,411	0.2	453,534	0.2	469,244	0.2	354,298	0.1
Student Health Center	10,397,723	4.5	9,475,752	4.1	9,699,824	4.2	10,353,677	4.1	10,854,460	4.3
Golf Course	956,425	0.4	891,305	0.4	880,091	0.4	812,224	0.3	479,288	0.2
Recreational Sports Fee Revenues ²	8,708,382	3.7	8,468,493	3.7	8,121,505	3.6	8,204,640	3.3	8,269,637	3.3
Lab School Revenues ²	1,084,616	0.5	1,106,871	0.5	1,099,472	0.5	1,091,935	0.4	1,087,531	0.4
LSU Press ³	1,776,044	0.8	1,210,539	0.5	1,394,405	0.6	1,261,821	0.5	1,237,574	0.5
Total	233,452,617	100%	231,475,032	100%	228,587,490	100%	250,861,675	100%	254,405,124	100%

¹ Percentages rounded to nearest tenth.

² Not an Auxiliary Enterprise, but (a) Lab School Revenues are deemed to constitute Auxiliary Revenues under the General Bond Resolution and any Supplemental Resolutions until the later of (i) July 1, 2034; and (ii) the maturity date of any bonds issued to finance or refinance projects for the Lab School; and (b) the Recreational Sports Fee Revenues are deemed to constitute Auxiliary Revenues under the General Bond Resolution and any Supplemental Resolutions until the later of (i) July 1, 2043; and (ii) maturity date of any bonds issued to finance or refinance projects for the Student Recreational Sports Complex.

³ Effective July 1, 2010, the LSU Press was restructured and the internal classification as an Auxiliary Enterprise was removed. Therefore, the LSU Press is no longer presented in the financial statements of the University as an Auxiliary Enterprise. However, for purposes of the Bonds issued pursuant to the General Bond Resolution and any Supplemental Resolutions, including, without limitation, the LSU Press is deemed to be an Auxiliary Enterprise, and the revenues of the LSU Press are deemed to be Auxiliary Revenues and are pledged as security for such Bonds.

Source: University

Auxiliary Revenues are used by the Board to fund the operations of the Auxiliary Enterprises and, therefore, all such amounts are not set aside for payment of Debt Service Requirements.

The Auxiliary Enterprises operate essentially as self-supporting enterprises with budgets for all operating expenses to be paid from self-generated revenues. Over the years, one or more of the Auxiliary Enterprises have, from time to time, failed to generate annual revenues sufficient to pay all expenses of operation. However, such deficiencies have been covered by fund balances on hand from previous operating surpluses and, on a combined basis, Auxiliary Revenues have historically exceeded expenses of Auxiliary Enterprises as shown below:

	FY 2015-16	FY 2016-17	FY 2017-18	FY 2018-19	FY 2019-20
Total Auxiliary Revenues ¹	\$ 233,452,617	\$ 231,475,032	\$ 228,587,490	\$ 250,861,675	\$ 254,405,124
Total Auxiliary Expenditures ²	211,036,327	209,909,974	214,244,259	238,715,809	250,024,386
Excess Auxiliary Revenues over Auxiliary Expenditures	\$ 22,416,290	\$ 21,565,058	\$ 14,343,231	\$ 12,145,866	\$ 4,380,738

¹ Includes Lab School Revenues until the later of (i) July 1, 2034 and (ii) the maturity date of any Auxiliary Revenue Bonds issued to finance or refinance projects for the Lab School, and Recreational Sports Fee Revenues until the later of (i) July 1, 2043 and (ii) the maturity date of any Outstanding Parity Bonds issued to finance or refinance projects for the Student Recreational Sports Complex.

² Includes debt service on Outstanding Parity Bonds.

Source: University

For additional information, see "APPENDIX A - DEMOGRAPHIC AND SUMMARY FINANCIAL INFORMATION RELATED TO THE UNIVERSITY" and "APPENDIX B - FINANCIAL REPORT OF THE LSU SYSTEM FOR THE YEAR ENDED JUNE 30, 2020."

OUTSTANDING PARITY BONDS

Outstanding Parity Bonds as of the expected date of the issuance of the Series 2022 Bonds are as follows:

<u>Description</u>	<u>Outstanding Principal</u>
Auxiliary Revenue Refunding Bonds, Series 2012 ⁽¹⁾	\$ 31,335,000
Auxiliary Revenue Bonds, Series 2013 ⁽¹⁾	48,840,000
Auxiliary Revenue Refunding Bonds, Series 2014 ⁽¹⁾	70,775,000
Auxiliary Revenue Refunding Bonds, Series 2016A ⁽¹⁾	115,400,000
Taxable Auxiliary Revenue Refunding Bonds, Series 2016B	10,980,000
Taxable Auxiliary Revenue Refunding Bonds, Series 2019	71,370,000
TOTAL	\$ 348,700,000

⁽¹⁾ All or a portion of which will be refunded using proceeds of the Series 2022 Bonds.

For more detail and additional information, including Debt Service Requirements for the Outstanding Parity Bonds, see "ANNUAL DEBT SERVICE REQUIREMENTS ON OUTSTANDING PARITY BONDS AND SERIES 2022 BONDS AND BASE RENTAL ON SUBORDINATE LEASE OBLIGATIONS", "PRO FORMA DEBT SERVICE AND BASE RENTAL COVERAGE RATIOS" and "APPENDIX B - FINANCIAL REPORT OF THE LSU SYSTEM FOR THE YEAR ENDED JUNE 30, 2020."

ANNUAL DEBT SERVICE REQUIREMENTS ON OUTSTANDING PARITY BONDS AND SERIES 2022 BONDS AND BASE RENTAL ON SUBORDINATE LEASE OBLIGATIONS

The following table sets forth the annual Debt Service Requirements for the Outstanding Parity Bonds (excluding the Refunded Bonds) and the Series 2022 Bonds and Base Rental on the Subordinate Lease Obligations for the Fiscal Years ending June 30, 2022 to June 30, 2059, inclusive. For more detail and additional information on the Subordinate Lease Obligations, see "**SECURITY FOR THE SERIES 2022 BONDS – Subordinate Lease Obligations and Payment Thereof.**"

Numbers in the following table may not add precisely due to rounding.

[Remainder of Page Intentionally Left Blank]

Fiscal Year Ending	Outstanding Parity Bonds ^{*(1)}	Series 2022 Bonds [*]			Total Parity Bonds ^{*(1)}	Subordinate Lease Obligations ⁽²⁾	Total Debt Service [*]
		Principal	Interest	Debt Service			
6/30/2022							
6/30/2023							
6/30/2024							
6/30/2025							
6/30/2026							
6/30/2027							
6/30/2028							
6/30/2029							
6/30/2030							
6/30/2031							
6/30/2032							
6/30/2033							
6/30/2034							
6/30/2035							
6/30/2036							
6/30/2037							
6/30/2038							
6/30/2039							
6/30/2040							
6/30/2041							
6/30/2042							
6/30/2043							
6/30/2044							
6/30/2045							
6/30/2046							
6/30/2047							
6/30/2048							
6/30/2049							
6/30/2050							
6/30/2051							
6/30/2052							
6/30/2053							
6/30/2054							
6/30/2055							
6/30/2056							
6/30/2057							
6/30/2058							
6/30/2059							
Total							

⁽¹⁾ Excludes the Refunded Bonds.

⁽²⁾ [Includes the Nicholson Gateway Facilities Lease, the Greenhouse District (Phase II) Facilities Lease and the Greenhouse District (Phase III) Facilities Lease.] See "**OUTSTANDING PARITY BONDS**" and "**SECURITY FOR THE SERIES 2022 BONDS – Subordinate Lease Obligations and Payment Thereof.**"

Source: University, except with respect to the annual Debt Service Requirements on the Series 2022 Bonds, which is provided by the Underwriter.

* Preliminary, subject to change.

PRO FORMA DEBT SERVICE AND BASE RENTAL COVERAGE RATIOS*

The following table shows the availability of [2020-2021] Auxiliary Revenues to satisfy (i) Debt Service Requirements on the Outstanding Parity Bonds (excluding the Refunded Bonds) and the Series 2022 Bonds (collectively, the "*Parity Lien Obligations*") and (ii) Base Rental on the [Nicholson Gateway Facilities Lease, the Greenhouse District (Phase II) Facilities Lease, and the Greenhouse District (Phase III) Facilities Lease] (collectively, the "*Subordinate Lease Obligations*" or the "*Facilities Lease*") on a pro forma basis. The University anticipates that the Net Auxiliary Revenues available for Debt Service Requirements and Base Rental will be sufficient to provide sufficient coverage for the life of the Parity Lien Obligations and the Subordinate Lease Obligations.

	[2020-21]
Gross Auxiliary Revenues ⁽¹⁾	
Total Auxiliary Expenditures ⁽²⁾	
Net Auxiliary Revenues	
	Pro Forma*
Maximum Debt Service Requirements on Parity Lien Obligations ⁽³⁾	
Gross Debt Service Coverage Ratio on Parity Lien Obligations ⁽⁴⁾	
Net Debt Service Coverage Ratio on Parity Lien Obligations ⁽⁵⁾	
Maximum Annual Debt Service Requirements on Parity Lien Obligations & Base Rental on Subordinate Lease Obligations ⁽³⁾	
Gross Debt Service Coverage Ratio on Parity Lien Obligations & Subordinate Lease Obligations ⁽⁶⁾	
Net Debt Service Coverage Ratio on Parity Lien Obligations & Subordinate Lease Obligations ⁽⁷⁾	

⁽¹⁾ Includes Lab School Revenues and Recreational Sports Fee Revenues. In the Twentieth Supplemental Resolution, the Board (a) confirms the pledge of and does thereby pledge the Lab School Revenues, as Auxiliary Revenues, as security for the payment of all Bonds Outstanding under the General Bond Resolution and any Supplemental Resolutions until the later of (i) July 1, 2034 and (ii) the maturity date of any Bonds issued to refinance projects for the Lab School, and (b) therein additionally confirm the pledge of, and does thereby pledge, the Recreational Sports Fee Revenues as Auxiliary Revenues as security for the payment of all Bonds Outstanding under the General Bond Resolution and any Supplemental Resolutions until the later of (i) July 1, 2043 and (ii) maturity date of any Bonds issued to refinance projects for the Student Recreational Sports Complex.

⁽²⁾ Excludes Debt Service Requirements on Parity Lien Obligations and Base Rental on Subordinate Lease Obligations.

⁽³⁾ Excludes Debt Service Requirements on the Refunded Bonds.

⁽⁴⁾ Gross Debt Service Coverage Ratio is calculated by dividing Gross Auxiliary Revenues by Maximum Annual Debt Service on the Parity Lien Obligations.

⁽⁵⁾ Net Debt Service Coverage Ratio is calculated by dividing Net Auxiliary Revenues by Maximum Annual Debt Service on the Parity Lien Obligations.

⁽⁶⁾ Gross Debt Service Coverage Ratio is calculated by dividing Gross Auxiliary Revenues by Annual Debt Service and Base Rental Requirements.

⁽⁷⁾ Net Debt Service Coverage Ratio is calculated by dividing Net Auxiliary Revenues by Annual Debt Service and Base Rental Requirements.

Source: University, except with respect to the Debt Service Requirements on the Series 2022 Bonds, which is provided by the Underwriter.

* Preliminary, subject to change.

THE SERIES 2022 BONDS

General

The Series 2022 Bonds will be issued pursuant to the Bond Resolution and the provisions of the Refunding Act, subject to the terms and conditions provided in the Bond Resolution. The principal of and interest on all Series 2022 Bonds issued under the provisions of the Bond Resolution shall be payable solely from Auxiliary Revenues and shall be entitled to the security and benefit of the Bond Resolution.

The Series 2022 Bonds are issuable as fully registered bonds without coupons in denominations of \$5,000 or any integral multiple thereof, initially in book-entry form, registered in the name of Cede & Co., as nominee of The Depository Trust Company, New York, New York ("*DTC*"). Purchasers of the Series 2022 Bonds will not receive physical delivery of bond certificates. Ownership interests may be acquired in book-entry form only. See "**BOOK-ENTRY ONLY SYSTEM**" in **APPENDIX H** hereto.

For a discussion of how ownership of the Series 2022 Bonds is to be transferred and how principal and interest are to be paid to and credited by DTC while the Series 2022 Bonds are registered in its name, see "**BOOK-ENTRY ONLY SYSTEM**" in **APPENDIX H** hereto. So long as such book-entry system is used, only DTC will receive or have the right to receive physical delivery of the Series 2022 Bonds and, except as otherwise provided herein with respect to Beneficial Owners of Beneficial Ownership Interests, Beneficial Owners will not be or be considered to be, and will not have any rights as, owner or holders of the Series 2022 Bonds under the Bond Resolution.

The Series 2022 Bonds will be dated the date of delivery, will mature on July 1 of each year thereafter in the principal amounts indicated on the inside front cover page of this Official Statement and will bear interest (computed on the basis of a 360-day year of twelve 30-day months) from the date of delivery thereof, payable on January 1 and July 1 of each year, (each an "*Interest Payment Date*") commencing July 1, 2022, at the rates per annum indicated on the inside front cover page hereof.

Interest on the Series 2022 Bonds shall be computed from the Interest Payment Date to which interest has been paid or duly provided for next preceding the date of authentication thereof, unless (a) such date of authentication shall be prior to the first Interest Payment Date, in which case interest shall be computed from the date of issuance of the Series 2022 Bonds, or (b) such date of authentication shall be an Interest Payment Date to which interest on the Series 2022 Bonds has been paid in full or duly provided for, in which case interest shall be computed from such date of authentication; provided, however, that if interest on the Series 2022 Bonds shall be in default, Series 2022 Bonds issued in exchange for Series 2022 Bonds surrendered for registration of transfer or exchange shall bear interest from the last date to which interest has been paid or duly provided for on the Series 2022 Bonds or, if no interest has been paid or duly provided for on the Series 2022 Bonds, from the date of delivery thereof.

Provisions Applicable if Book-Entry Only System is Terminated

Payment of Principal and Interest. Purchasers of the Series 2022 Bonds will receive principal and interest payments pursuant to the following provisions only if the book-entry only system is terminated. Otherwise, payments and transfers will be made only as described under "**BOOK-ENTRY ONLY SYSTEM**" in **APPENDIX H** hereto.

Principal of any Series 2022 Bonds which have become due and payable, together with any applicable redemption premium, will be payable only upon presentation and surrender of such Series 2022 Bonds at the principal corporate trust office of the Paying Agent.

Interest on the Series 2022 Bonds (except defaulted interest) will be paid to the Persons who are the Owners of the Series 2022 Bonds at the close of business on the Record Date next preceding the Interest Payment Date. Defaulted interest shall be paid as provided in the General Bond Resolution. Interest shall be paid by check of the Paying Agent mailed on the Interest Payment Date to the Owners at their addresses as they appear on the Bond Register or at such other address as is furnished in writing by an Owner to the Paying Agent prior to the Record Date.

Any Owner of Series 2022 Bonds in an aggregate principal amount of at least \$1,000,000 may, however, elect to have interest payments made to such Owner by wire transfer of Federal Funds. In order to make such election, the Owner must notify the Trustee in writing and provide wire transfer instructions prior to the Record Date for the Interest Payment Date on which such wire transfer payments are to commence. Once an election is made, all subsequent interest payments to such Owner shall be by wire transfer, according to the last wire transfer instructions received prior to the Record Date. The Owner may revoke or change such instructions by delivering a written notice to the Trustee. Such instructions may also provide for the payment of principal and premium by wire transfer of Federal Funds (following presentation and surrender of the Series 2022 Bonds being paid).

Principal of and interest on the Series 2022 Bonds shall be payable in such coin or currency of the United States of America which is legal tender for payment of public and private debts.

Each payment of principal of and interest on Series 2022 Bonds shall be accompanied by notice of the CUSIP number of such Series 2022 Bonds.

Exchange and Transfer. As long as Series 2022 Bonds will be in book-entry form, the transfer and exchange of the Series 2022 Bonds will be made in accordance with the procedures of DTC as more fully described under "**BOOK-ENTRY ONLY SYSTEM**" in **APPENDIX H** hereto. Otherwise the transfer and exchange of Series 2022 Bonds will be made as described in the following paragraph.

The Series 2022 Bonds may be transferred and assigned only upon the registration books maintained by the Paying Agent. Upon surrender for registration of transfer of any Series 2022 Bond, the Paying Agent will register and deliver in the name of the transferee or transferees one or more new fully registered Series 2022 Bonds of Authorized Denominations of the same maturity and like aggregate principal amount. At the option of an Owner, Series 2022 Bonds may be exchanged for other Series 2022 Bonds of Authorized Denominations of the same maturity and like aggregate principal upon surrender at such office. Whenever any Series 2022 Bonds are so surrendered for exchange, the Paying Agent will register and deliver in exchange thereof the Bond or Bonds which the Owner making the exchange will be entitled to receive after receipt of the Series 2022 Bonds to be transferred in proper form. All Series 2022 Bonds presented for registration of transfer or exchange will (if so required by the Board or the Paying Agent) be accompanied by a written instrument or instruments of transfer in form and with a guaranty of signature satisfactory to the Paying Agent, duly executed by the Owner or by such Owner's duly authorized attorney. No charge will be made to the Owner for any exchange or transfer of Series 2022 Bonds, but the Paying Agent may require payment of a sum sufficient to cover any tax, fee or other governmental charge that may be imposed in relation thereto. The Board and the Paying Agent will not be required to issue, register the transfer of or exchange (a) any Series 2022 Bonds during a period beginning at the opening of business on the Regular Record Date and ending at the close of business on the Interest Payment Date or (b) any Series 2022 Bond called for redemption prior to maturity during a period beginning on the opening of business fifteen (15) days before the date of the mailing of notice of redemption of such Series 2022 Bonds and ending on the date of such redemption. All Series 2022 Bonds delivered upon any registration of transfer or exchange of Series 2022 Bonds will be valid obligations of the Board, evidencing the same debt and entitled to the same benefits under the Bond Resolution as the Series 2022 Bonds surrendered upon authentication thereof by the Paying Agent. Prior to due presentment for registration of transfer of any Series 2022 Bond, the Board, the Paying Agent, and any agent of the Board or the Paying Agent may

treat the person in whose name any Series 2022 Bond is registered as the absolute owner thereof for all purposes (subject to provisions concerning Special Record Dates) whether or not such Series 2022 Bonds will be overdue, and will not be bound by any notice to the contrary.

Redemption Provisions*

Optional Redemption. Beginning on or after July 1, 20__, the Board may redeem Series 2022 Bonds maturing on or after July 1, 20__ in whole on any date or in part as selected by the Trustee by lot at the direction of the Board (in denominations of \$5,000 or any integral multiple thereof) from time to time on any Interest Payment Date, at a price equal to the par amount thereof, plus accrued interest to the redemption date.

Extraordinary Optional Redemption without Premium. The Board may at any time redeem all or any part (in Authorized Denominations) of the Series 2022 Bonds at a redemption price equal to their principal amount plus accrued interest to the redemption date if a particular Auxiliary Facility refinanced by the Series 2022 Bonds is damaged, destroyed or taken by eminent domain or sold under the threat of condemnation and the Board elects pursuant to the damage, destruction and condemnation provisions of the Bond Resolution to use the Net Proceeds of casualty insurance or condemnation or sale under threat of condemnation to redeem Series 2022 Bonds rather than repair, replace, rebuild or restore the Auxiliary Facility. Any such redemption must take place within 120 days following the receipt of casualty insurance or condemnation proceeds relating to such damage, destruction or taking.

The Board will use its reasonable best efforts to repair, replace, rebuild or restore such Auxiliary Facility; however, should it elect to use Net Proceeds to redeem the Series 2022 Bonds, the Board will give the Trustee at least 35 days' notice of any extraordinary optional redemption described in the above paragraph. The notice will specify the redemption date and the principal amounts and maturities of Series 2022 Bonds to be redeemed.

Mandatory Sinking Fund Redemption. The Series 2022 Bonds maturing July 1, 20__* shall be subject to mandatory redemption in the following principal amounts ("*Sinking Fund Amounts*") on the following dates by lot in such manner as shall be determined by the Trustee at a redemption price equal to their principal amount plus accrued interest to the redemption date.

Year* (July 1)	Principal Amount
_____	\$_____,000
_____	_____,000
_____	_____,000
_____	_____,000
_____ ¹	_____,000

¹Final maturity.

[However, if Series 2022 Bonds have been redeemed pursuant to the Bond Resolution or if the Board has delivered Series 2022 Bonds to the Trustee for cancellation, the Board may direct that any Sinking Fund Amount be reduced by an amount equal to all or a portion of the principal amount of any Series 2022 Bonds so redeemed or delivered for cancellation (and not previously used to reduce any Sinking Fund Amount). The Board shall deliver any such direction at least 75 days before the redemption date.

* Preliminary, subject to change.

If amounts are being held in the 2022 Principal Account of the Bond Fund to be used to redeem Series 2022 Bonds pursuant to the Bond Resolution in lieu of such redemption, the Board may, no later than 75 days before the redemption date, direct the Trustee in writing to use part or all of such moneys to purchase such Series 2022 Bonds, in a principal amount not to exceed the next Sinking Fund Amount, which Series 2022 Bonds are presented to it by Owners for purchase and which the Board directs the Trustee to purchase. The purchase price of such Series 2022 Bonds shall not exceed the redemption price of the Series 2022 Bonds which would be redeemed but for the operation of this paragraph (accrued interest to be paid from the same Fund or Account from which accrued interest would be paid upon the redemption of such Series 2022 Bonds). Any such purchase shall be completed prior to the time notice would otherwise be required to be given to redeem Series 2022 Bonds. All Series 2022 Bonds so purchased shall be cancelled and applied as a credit (in an amount equal to the principal amount of such Series 2022 Bonds) against the next Sinking Fund Amount.]

Notice of Redemption of Series 2022 Bonds. At least 30 days, but not more than 60 days, before a redemption date other than mandatory sinking fund redemption, the Trustee shall mail a notice of redemption to the Owner of each Series 2022 Bond which is to be redeemed. The notice shall be sent by first class, registered or certified mail if the Owner holds \$1,000,000 or more in principal amount of Series 2022 Bonds. The failure of the Trustee to mail notice of redemption to any Owner or any defect in any notice of redemption shall not affect the validity of the redemption of any other Series 2022 Bond.

Each notice of redemption shall state the following with respect to the Series 2022 Bonds being redeemed: (1) the complete name of the Series 2022 Bonds; (2) the redemption date; (3) the redemption price; (4) the date of the notice; (5) the issue date; (6) the interest rate; (7) the maturity date; (8) the CUSIP number; (9) that the Series 2022 Bonds called for redemption must be surrendered to the Trustee to collect the redemption price; (10) the Trustee's name and address; (11) that interest on Series 2022 Bonds called for redemption ceases to accrue on and after the redemption date; and (12) any other items which may be necessary or desirable to comply with regulation or custom.

If less than all the Series 2022 Bonds are to be redeemed, the notice of redemption shall specify the numbers and amounts of the Series 2022 Bonds or portion thereof to be redeemed. The notice of redemption relative to the Series 2022 Bonds shall state that it is conditioned on there being sufficient money on deposit to pay the full redemption price of the Series 2022 Bonds.

Two Business Days prior to mailing notice to other Series 2022 Bondholders, a copy of each notice of redemption shall be sent by the Trustee by certified or registered mail to DTC or its nominee which holds any Series 2022 Bonds, provided that the Trustee may, in its discretion, provide for overnight, telecopied or other form of notice to DTC acceptable to or requested thereby. The Trustee shall file, on the same date notices are mailed to other Bondholders, a copy of each notice of redemption with EMMA.

If a Series 2022 Bond is not presented for payment on or within 30 days after its redemption date, the Trustee shall, as soon as reasonably possible, mail a second notice of redemption to the last Owner of record of such Series 2022 Bond, including the same information as in the first notice. The giving of such notice, or the failure to give such notice or any defect in such notice, shall not affect the validity of the redemption of any Series 2022 Bonds.

Payment of Redeemed Bonds. Notice having been given in the manner provided in the Twentieth Supplemental Resolution and money for the payment of the redemption price of the Series 2022 Bonds or portions thereof to be redeemed is held by the Trustee, then on the redemption date designated in such notice the Series 2022 Bonds or portions thereof so called for redemption shall become payable at the redemption price as specified in such notice; and from and after the redemption date so designated, interest thereon or portions thereof so called for redemption shall cease to accrue, such Series 2022 Bonds or portions thereof shall cease to be entitled to any benefit, protection or security under the Twentieth

Supplemental Resolution and the Owners of such Series 2022 Bonds or portions thereof shall have no rights in respect thereof except to receive payment of the redemption price.

SUBORDINATE LEASE OBLIGATIONS AND PAYMENT THEREOF

General. To meet the need for additional high quality student housing on the main campus of the University, the University and LSU Property Foundation, a private nonprofit corporation organized and existing under the laws of the State (the "*Property Foundation*"), and an exempt organization as described and defined in Section 501(c)(3) of the Internal Revenue Code of 1986, as amended (the "*Code*") engaged in an extensive selection process in 2015 and 2016, ultimately partnering with Provident Group - Flagship Properties L.L.C. ("*Provident Flagship*"), which engaged Rise Residential LLC ("*RISE*"), a limited liability company organized and existing under the laws of the State of Georgia and authorized to do business in the State (the "*Developer*") to develop, in four phases (the total plan of finance is estimated to be \$575,000,000) over a five-year period, approximately 1,955 beds of new housing facilities and the redevelopment of approximately 2,850 existing beds, as well as the construction of a student recreation center, surface parking and an 808-space parking deck and approximately 40,000 square feet of retail space (collectively, the "*Development*"). The Board is obligated under leases entered into in connection with each phase of the Development to make rent payments solely from the Auxiliary Revenues of the University, subordinate and junior in all respects to the payment of debt service on, and the pledge of the Auxiliary Revenues to, the Parity Lien Obligations and the Series 2022 Bonds, as further described below under "*Nicholson Gateway*," "*Greenhouse District (Phase II)*," "*Greenhouse District (Phase III)*," and "*Payment*." The Board expects to incur additional subordinate lease obligations at some point in the future to finance the fourth phase of the Development; however, the Board is currently evaluating enrollment trends and cannot, at this time, predict when the fourth phase of the Development will take place.

Nicholson Gateway. The first phase of the Development was financed by \$226,795,000 original aggregate principal amount of Lease Revenue Bonds (Provident Group-Flagship Properties L.L.C. - Louisiana State University Nicholson Gateway Project) Series 2016A and \$8,500,000 original aggregate principal amount of Taxable Lease Revenue Bonds (Provident Group-Flagship Properties L.L.C. - Louisiana State University Nicholson Gateway Project) Series 2016B (collectively, the "*Nicholson Gateway Bonds*"), which were issued by the Louisiana Public Facilities Authority (the "*Authority*") on September 28, 2016, to provide funds to (i) finance the demolition and abatement of certain existing facilities and the design, acquisition, development, construction, furnishing and equipping of a certain mixed-use development known as "Nicholson Gateway" and the student housing facility known as "Spruce Hall" (collectively, the "*Nicholson Gateway Project*"), to consist of student housing facilities, with all buildings, improvements, fixtures, furnishings, equipment and amenities necessary for the operation thereof (the "*Nicholson Gateway Student Housing Facilities*"), together with market retail space, a parking garage facility, surface parking and associated site infrastructure and various related amenities as same may be expanded from time to time under the master plan, utilities and improvements (collectively, the "*Nicholson Gateway Facility*") at the University.

The proceeds of the Nicholson Gateway Bonds were loaned by the Authority to Provident Flagship pursuant to the terms of the Loan Agreement dated as of September 1, 2016 (the "*Nicholson Gateway Loan Agreement*"), by and between the Authority and Provident Flagship, and was used to pay the cost of the Nicholson Gateway Project, which was timely completed in August 2018. Provident Flagship is a Louisiana limited liability company, the sole member of which is Provident Resources Group Inc., a non-profit corporation duly organized and existing under the laws of the State of Georgia and an exempt organization as described and defined in Section 501(c)(3) of the Code.

Pursuant to the terms of a ground lease, Nicholson Gateway Project, LLC, a Louisiana limited liability company the sole member of which is the Foundation, leases from the Board the land (the "*Nicholson Gateway Land*") upon which the Nicholson Gateway Facility is located. The Foundation is

operated for the purpose of providing private financial support for the University, including the planning and construction of facilities of various types for the benefit of the University and its academic programs.

Nicholson Gateway LLC subleases the Land to Provident Flagship, and Provident Flagship engaged RISE to develop, design and construct the Nicholson Gateway Facility pursuant to a development agreement.

Pursuant to the Nicholson Gateway Facilities Lease dated as of September 1, 2016 (the "*Nicholson Gateway Facilities Lease*"), by and between Provident Flagship and the Board, Provident Flagship subleases the Nicholson Gateway Land and leases the Nicholson Gateway Facility to the Board. Pursuant to the Nicholson Gateway Facilities Lease, the University is responsible for, among other things, the residential life operations of the Nicholson Gateway Student Housing Facilities, and Provident Flagship has engaged RISE Residential, LLC, a limited liability company organized and existing under the laws of the State of Georgia authorized to do business in Louisiana, to be responsible for all other operations and maintenance of the Nicholson Gateway Facility pursuant to and in accordance with a facilities operations and maintenance agreement.

Greenhouse District (Phase II). The second phase of the Development was financed by \$87,705,000 original aggregate principal amount of Lease Revenue Bonds (Provident Group-Flagship Properties L.L.C. - Louisiana State University Nicholson Gateway Project) Series 2017 (the "*Greenhouse District (Phase II) Bonds*"), which were issued by the Authority on October 3, 2017, to provide funds to finance (i) the design, acquisition, development, construction, furnishing and equipping of (a) student housing facilities consisting of the construction of a new Cedar Hall and the renovation of Evangeline Hall and the abatement and renovation of Highland Hall, together with all buildings, improvements, fixtures, furnishings, equipment and associated site infrastructure and amenities necessary for the operation thereof (collectively, the "*Greenhouse District (Phase II) Student Housing Facilities*") and (b) new greenhouse facilities to be located on Ben Hur Drive and existing greenhouse facilities located on Gourrier Drive, including, without limitation, related facilities and associated site infrastructure and amenities necessary for the operation thereof and (ii) the demolition of the existing Kirby Smith Hall and certain existing greenhouse facilities located on the main campus of the University, including, without limitation, related facilities and associated site infrastructure (collectively, the "*Greenhouse District (Phase II) Facility*").

The proceeds of the Greenhouse District (Phase II) Bonds were loaned by the Authority to Provident Flagship pursuant to the terms of the Loan Agreement dated as of October 1, 2017 (the "*Greenhouse District (Phase II) Loan Agreement*"), by and between the Authority and Provident Flagship, and was used to pay the cost of the Greenhouse District (Phase II) Project, which was timely completed in August 2021.

Pursuant to the terms of a ground lease, Greenhouse District Project LLC ("*GDPLLC*"), the sole member of which is the LSU Real Estate and Facilities Foundation, leases from the Board the land (the "*Greenhouse District (Phase II) Land*") upon which the Greenhouse District (Phase II) Facility is located.

GDPLLC subleases the Greenhouse District (Phase II) Land to Provident Flagship, and Provident Flagship engaged RISE to develop, design and construct the Greenhouse District (Phase II) Facility pursuant to a development agreement.

Pursuant to the Greenhouse District (Phase II) Facilities Lease dated as of October 1, 2017 (the "*Greenhouse District (Phase II) Facilities Lease*"), by and between Provident Flagship and the Board, Provident Flagship subleases the Greenhouse District (Phase II) Land and leases the Greenhouse District (Phase II) Facility to the Board. Pursuant to the Greenhouse District (Phase II) Facilities Lease, the University is responsible for, among other things, the residential life operations of the Greenhouse District (Phase II) Student Housing Facilities, and Provident Flagship has engaged RISE Residential, LLC, to be

responsible for all other operations and maintenance of the Greenhouse District (Phase II) Student Housing Facilities pursuant to and in accordance with a facilities operations and maintenance agreement.

Greenhouse District (Phase III). The third phase of the Development was financed by \$80,385,000 original aggregate principal amount of Lease Revenue Bonds (Provident Group-Flagship Properties L.L.C. - Louisiana State University Greenhouse District (Phase III) Project) Series 2019A and \$250,000 original aggregate principal amount of Taxable Lease Revenue Bonds (Provident Group-Flagship Properties L.L.C. - Louisiana State University Greenhouse District (Phase III) Project) Series 2019B (collectively, the "*Greenhouse District (Phase III) Bonds*"), which were issued by the Authority on September 26, 2019, to provide funds to finance two new student housing facilities consisting of 881 beds, together with all buildings, improvements, fixtures, furnishings, equipment and associated site infrastructure and amenities necessary for the operation thereof (the "*Greenhouse District (Phase III) Student Housing Facilities*"), certain parking facilities and other facilities, together with all improvements, fixtures, furnishings, equipment and associated site infrastructure and amenities necessary for the operation thereof (collectively, the "*Greenhouse District (Phase III) Facility*").

The proceeds of the Greenhouse District (Phase III) Bonds were loaned by the Authority to Provident Flagship pursuant to the terms of the Loan Agreement dated as of September 1, 2019 (the "*Greenhouse District (Phase III) Loan Agreement*"), by and between the Authority and Provident Flagship, and will be used to pay the cost of the Greenhouse District (Phase III) Project, which is expected to be completed in August 2021.

Pursuant to the terms of a ground lease, GDPLLC leases from the Board the land (the "*Greenhouse District (Phase III) Land*") upon which the Greenhouse District (Phase III) Facility is located.

GDPLLC subleases the Greenhouse District (Phase III) Land to Provident Flagship, and Provident Flagship engaged RISE to develop, design and construct the Greenhouse District (Phase III) Facility pursuant to a development agreement.

Pursuant to the Greenhouse District (Phase III) Facilities Lease dated as of September 1, 2019 (the "*Greenhouse District (Phase III) Facilities Lease*"), by and between Provident Flagship and the Board, Provident Flagship subleases the Greenhouse District (Phase III) Land and leases the Greenhouse District (Phase III) Facility to the Board. Pursuant to the Greenhouse District (Phase III) Facilities Lease, the University is responsible for, among other things, the residential life operations of the Greenhouse District (Phase III) Student Housing Facilities, and Provident Flagship has engaged RISE Residential, LLC, to be responsible for all other operations and maintenance of the Greenhouse District (Phase III) Student Housing Facilities pursuant to and in accordance with a facilities operations and maintenance agreement.

Payment. The Board is obligated under the Subordinate Lease Obligations to pay rental to Provident Flagship in amounts sufficient to pay, among other things, debt service on the Nicholson Gateway Bonds, the Greenhouse District (Phase II) Bonds and the Greenhouse District (Phase III) Bonds ("*Base Rental*" or "*Base Rental Requirement*"). The Board's obligation to pay Base Rental is payable solely from the Auxiliary Revenues of the University on a basis subordinate and junior in all respects to the payment of debt service on, and the pledge of the Auxiliary Revenues to, the Outstanding Bonds and the Series 2022 Bonds.

IN ACCORDANCE WITH THE GENERAL BOND RESOLUTION, PAYMENTS OF BASE RENTAL BY THE BOARD PURSUANT TO THE "SUBORDINATE LEASE OBLIGATIONS ARE SUBORDINATE AND JUNIOR IN ALL RESPECTS TO THE DEBT SERVICE REQUIREMENTS OF, AND THE PLEDGE OF THE AUXILIARY REVENUES TO, THE OUTSTANDING PARITY BONDS HERETOFORE AND HEREAFTER ISSUED

(INCLUDING THE SERIES 2022 BONDS) BY THE BOARD PURSUANT TO AND SECURED BY THE BOND RESOLUTION.

See "**ANNUAL DEBT SERVICE REQUIREMENTS ON OUTSTANDING PARITY BONDS AND SERIES 2022 BONDS AND BASE RENTAL ON SUBORDINATE LEASE OBLIGATIONS**" and "**PRO FORMA DEBT SERVICE AND BASE RENTAL COVERAGE RATIOS**" herein for additional information regarding the Subordinate Lease Obligations.

SECURITY FOR THE SERIES 2022 BONDS

General

Pursuant to the Bond Resolution, the payment of the principal of, redemption premium, if any, and the interest on the Series 2022 Bonds is payable from a pledge to the Trustee of the Auxiliary Revenues on a parity with the Outstanding Parity Bonds and any Additional Bonds.

THE PAYMENT OF THE PRINCIPAL OF AND INTEREST ON THE SERIES 2022 BONDS IS A SPECIAL AND LIMITED OBLIGATION OF THE BOARD PAYABLE SOLELY FROM THE AUXILIARY REVENUES.

THE AUXILIARY REVENUES ARE PLEDGED TO THE PAYMENT OF THE SERIES 2022 BONDS ON A PARITY WITH THE BOARD'S OUTSTANDING PARITY BONDS AND ANY ADDITIONAL BONDS.

For purposes of the Twentieth Supplemental Resolution and this Official Statement, references therein and herein to the term "Auxiliary Revenues" shall be deemed to include Lab School Revenues and Recreational Sports Fee Revenues with the caveat that the pledge of such revenues is limited as set forth in the Twentieth Supplemental Resolution and as described herein under "**THE AUXILIARY ENTERPRISES.**"

PURSUANT TO THE GENERAL BOND RESOLUTION, THE DEFINITIONS OF AUXILIARY REVENUES AND AUXILIARY FACILITIES MAY BE MODIFIED BY A SUPPLEMENTAL RESOLUTION ADOPTED WITHOUT CONSENT OF THE OWNERS OF THE SERIES 2022 BONDS, PROVIDED NO SUCH MODIFICATION SHALL RESULT IN A MATERIAL ADVERSE CHANGE IN COLLECTIONS OF AUXILIARY REVENUES.

AUXILIARY REVENUES DO NOT INCLUDE FUNDS APPROPRIATED TO THE UNIVERSITY BY THE LEGISLATURE OF THE STATE FROM TIME TO TIME.

See "**THE AUXILIARY ENTERPRISES**" herein.

Pledge

All of the Board's right, title and interest to the Auxiliary Revenues are pledged by the Board for the payment of Debt Service Requirements on the Series 2022 Bonds and on the Outstanding Parity Bonds (except as otherwise provided in the General Bond Resolution). The obligation of the Board to pay Debt Service Requirements from Auxiliary Revenues as provided in the Bond Resolution shall be on a parity with the Board's Outstanding Parity Bonds and any Additional Bonds. See "**OUTSTANDING PARITY BONDS**" herein.

Monies in funds or accounts held by the Board which are derived from Auxiliary Revenues will remain subject to the pledge described in the previous sentence. However, such portions of the Auxiliary

Revenues in excess of that needed for the payment of Outstanding Parity Bonds and the Series 2022 Bonds, and for transfer to the Bond Fund or Reserve Funds for Outstanding Parity Bonds and the Series 2022 Bonds will be available to the Board to pay Current Expenses, any Subordinated Debt and for any other lawful purpose of the Board, provided that the pledge of Auxiliary Revenues will be deemed to be a cumulative pledge in the event collections for any six month period are insufficient to make a required deposit.

The principal of an interest on the Series 2022 Bonds are payable solely from the Auxiliary Revenues and are not general obligations of the University, the Board, the State or any political subdivision thereof, and neither the faith and credit of the State nor the Board is pledged to the payment of the principal of or interest on the Series 2022 Bonds.

No Superior Pledge

The Board will grant no security interest or lien of any type in the Auxiliary Revenues which is superior to the security interest created by the Bond Resolution for the Series 2022 Bonds and the Outstanding Parity Bonds and will issue no debt or obligation which is to be paid from Auxiliary Revenues prior to payment of principal of and interest on the Series 2022 Bonds and the Outstanding Parity Bonds and the other payments required under the Bond Resolution. Except for the Outstanding Parity Bonds and Additional Bonds authorized pursuant to the Bond Resolution, the Board will grant no security interest or lien or encumbrance of any type on the Auxiliary Revenues which is on a parity with the pledge made by the Board pursuant to the Bond Resolution. See "**Subordinate Lease Obligations**" herein.

Special and Limited Obligations

THE SERIES 2022 BONDS ARE SPECIAL AND LIMITED OBLIGATIONS OF THE BOARD PAYABLE SOLELY FROM AUXILIARY REVENUES, THE LAB SCHOOL REVENUES AND THE RECREATIONAL SPORTS FEE REVENUES; PROVIDED THAT (a) THE PLEDGE OF THE LAB SCHOOL REVENUES WILL LAPSE ON THE LATER OF (i) JULY 1, 2034 AND (ii) THE MATURITY DATE OF ANY BONDS ISSUED TO FINANCE OR REFINANCE PROJECTS FOR THE LAB SCHOOL AND (b) THE PLEDGE OF RECREATIONAL SPORTS FEE REVENUES WILL LAPSE ON THE LATER OF (i) JULY 1, 2043 AND (ii) THE MATURITY DATE OF ANY BONDS ISSUED TO FINANCE OR REFINANCE PROJECTS FOR THE STUDENT RECREATIONAL SPORTS COMPLEX. THE SERIES 2022 BONDS SHALL NOT CONSTITUTE AN INDEBTEDNESS OR PLEDGE OF THE GENERAL CREDIT OF THE UNIVERSITY, LSU, THE BOARD, THE STATE OR ANY POLITICAL SUBDIVISION THEREOF WITHIN THE MEANING OF ANY CONSTITUTIONAL OR STATUTORY LIMITATION OF INDEBTEDNESS AND SHALL CONTAIN A RECITAL TO THAT EFFECT. NEITHER THE STATE NOR ANY AGENCY OR POLITICAL SUBDIVISION THEREOF, OTHER THAN THE BOARD, SHALL BE OBLIGATED TO PAY THE PRINCIPAL OF THE SERIES 2022 BONDS OR THE INTEREST THEREON, AND THE SERIES 2022 BONDS SHALL NOT BE DEEMED TO CONSTITUTE A DEBT OR LIABILITY OF THE STATE OR ANY AGENCY OR POLITICAL SUBDIVISION OR AGENCY THEREOF, OTHER THAN THE BOARD.

THE AUXILIARY REVENUES, THE LAB SCHOOL REVENUES AND THE RECREATIONAL SPORTS FEE REVENUES ARE PLEDGED TO THE PAYMENT OF THE SERIES 2022 BONDS ON A PARITY WITH THE BOARD'S OUTSTANDING PARITY BONDS AND ANY ADDITIONAL BONDS; PROVIDED THAT (a) THE LAB SCHOOL REVENUES SHALL BE SO PLEDGED ONLY UNTIL THE LATER OF (i) JULY 1, 2034 AND (ii) THE MATURITY DATE OF ANY BONDS ISSUED TO FINANCE OR REFINANCE PROJECTS FOR THE LAB SCHOOL, AND (b) THE RECREATIONAL SPORTS FEE REVENUES SHALL BE SO PLEDGED ONLY UNTIL THE LATER OF (i) JULY 1, 2043 AND (ii) THE MATURITY DATE OF ANY BONDS ISSUED TO

FINANCE OR REFINANCE PROJECTS FOR THE STUDENT RECREATIONAL SPORTS COMPLEX.

For purposes of the Twentieth Supplemental Resolution and this Official Statement, references therein and herein to the term "Auxiliary Revenues" shall be deemed to include Lab School Revenues and Recreational Sports Fee Revenues with the caveat that the pledge of such revenues is limited as set forth in the foregoing paragraph.

THE FUTURE AVAILABILITY OF AUXILIARY REVENUES IS DEPENDENT UPON THE CONTINUED OPERATION OF THE UNIVERSITY, WHICH IS PRIMARILY FUNDED BY STUDENT TUITION AND FEES AND STATE APPROPRIATIONS, NONE OF WHICH ARE PLEDGED TO, NOR AVAILABLE FOR, THE PAYMENT OF THE SERIES 2022 BONDS.

Rate Maintenance Covenant; Rules and Adequacy of Charges for Use of the Auxiliary Facilities

The Board covenants in the General Bond Resolution that it will establish and maintain, so long as any of the Series 2022 Bonds remain Outstanding, such fees, rates and charges for the use and enjoyment of the Auxiliary Facilities and the services provided thereby as will be necessary to assure adequate occupancy and use of the same and the services afforded thereby and as will provide and generate Auxiliary Revenues (not including Funds and Accounts held pursuant to the Bond Resolution) projected to equal no less than the amount required for payment of the Debt Service Requirements on the Bonds, Current Expenses of the Auxiliary Facilities, the Reserve Requirement on the Bonds and to make all other payments and charges as are required under the Bond Resolution. See "**Approval for Fees and Tuition Increases**" below.

Approval for Fees and Tuition Increases

Unlike most other states, Louisiana's Constitution requires a supermajority vote in both chambers of the Legislature to approve tuition and fee increases. Higher education has been provided multi-year limited fee authority since 2010. Act 377 of the 2015 Regular Session of the Louisiana Legislature provided postsecondary management boards with the authority to establish mandatory fees and increase those fees through June, 30, 2017. Act 293 of the 2017 Regular Session of the Louisiana Legislative extended the authority of postsecondary management boards to establish, adjust, and increase certain fees through the June 30, 2020. It is expected that the public higher education systems will request a tuition authority for another multi-year increment. The State's merit-based scholarship program, Taylor Opportunity Program for Students ("*TOPS*"), was disassociated with tuition in 2017, meaning that the State is now only providing a limited grant to students. The value of TOPS is based on the award level provided in Fall 2017, which was equal to total tuition (excluding fees) charged that year at each public higher education institution.

Deposit and Disposition of Auxiliary Revenues

Amounts equal to the aggregate of (i) the amount of interest payable on the Series 2022 Bonds on the next Interest Payment Date and (ii) the amount of principal due on the Series 2022 Bonds on the next Principal Payment Date shall be transferred by the Board from Auxiliary Revenues by check or draft on or prior to the fifth day, or wire transfer on or prior to the third day, immediately preceding each January 1 and July 1, as the case may be, commencing July 1, 2022, with respect to the first Interest Payment Date and the first Principal Payment Date, to the Series 2022 Interest Account and the Series 2022 Principal Account, as the case may be, held by the Trustee until necessary for the Trustee to transfer funds to the Paying Agent for payment of the interest or any principal of the Series 2022 Bonds.

Additional Bonds

The Board may issue no bonds, notes or other obligations secured by Auxiliary Revenues except as Additional Bonds or as Subordinated Debt, as described below; provided, however, that the Board may incur obligations relating to Hedging Transactions payable from and, to the extent permitted by law, secured by Auxiliary Revenues in connection with Outstanding Bonds and in connection with the issuance of Additional Bonds. The Board may issue Additional Bonds secured by Auxiliary Revenues which will be on a parity with the Outstanding Parity Bonds and the Series 2022 Bonds only as and to the extent authorized and described in a Supplemental Resolution, provided that, at the time of issuance thereof, no Event of Default or event which with notice or lapse of time, or both, would constitute an Event of Default shall have occurred and be continuing, unless such event will be cured upon issuance of such bonds and either the application of the proceeds thereof or the placing in service of any facilities financed thereby or both. The Bond Resolution permits the issuance of Additional Bonds as follows:

(A) Additional Bonds may be issued without the need for prior approval of Bondholders or any Credit Facility provider, provided that the Debt Service Coverage Ratio for each of the last two completed Fiscal Years for which the financial statements of the Board have been reported upon by an Accountant, taking into account the Outstanding Parity Bonds, other Bonds previously issued and the Additional Bonds then proposed to be issued, is not less than 1.75 and an Authorized Board Representative's certificate so certifying and setting forth in sufficient detail the computation thereof is filed with the Trustee and any Credit Facility provider along with the financial statements and report of the Accountants thereon if they are not already on file with the Trustee and the Credit Facility providers.

(B) Should the Debt Service Coverage Ratio be less than that required as described in paragraph (A) above, and Additional Bonds are proposed to be issued to fund improvements, renovations or new construction, such Additional Bonds may be issued if (i) a Projection demonstrates compliance with the Debt Service Coverage Ratio required by paragraph (A) above, upon completion of the improvements, renovations or new construction and (ii) the Board shall have received the prior written approval of all Credit Facility providers, if any. Such Projection will be filed with any Credit Facility provider and the Trustee by an Authorized Board Representative.

Subordinated Debt

The General Bond Resolution provides that the Board may, at any time, or from time to time, issue or incur Subordinated Debt, pursuant to the Act, for any of its lawful purposes, payable out of, and which may be secured by a pledge of, such amounts in the Subordinated Debt Fund as may from time to time be available for the purpose of payment thereof; provided, however, that such pledge will be, and will be expressed to be, subordinate and junior in all respects to the pledge created by the Bond Resolution as security for the Outstanding Parity Bonds, the Series 2022 Bonds and any Additional Bonds. See "**SUBORDINATE LEASE OBLIGATIONS AND PAYMENT THEREOF**" and "**FUTURE FINANCING PLANS**" herein.

Funds and Accounts Created Under the Bond Resolution

The General Bond Resolution creates the following special trust funds to be held by the Trustee:

- (i) Louisiana State University and Agricultural and Mechanical College Auxiliary Revenue Bonds Project Fund (the "*Project Fund*"), which shall consist of a Project Account for each Series of Bonds, as applicable, into which shall be deposited the

proceeds of the related Series of Bonds or other funds necessary to pay related Project Costs, as defined in a Supplemental Resolution;

- (ii) Louisiana State University and Agricultural and Mechanical College Auxiliary Revenue Bonds Bond Fund (the "*Bond Fund*"), which shall consist of a Principal Account and an Interest Account for each Series of Bonds;
- (iii) Louisiana State University and Agricultural and Mechanical College Auxiliary Revenue Bonds Reserve Fund (the "*Reserve Fund*"), which shall consist of a Reserve Account, if required, for each Series of Bonds; and
- (iv) Louisiana State University and Agricultural and Mechanical College Auxiliary Revenue Bonds Subordinated Debt Fund (the "*Subordinated Debt Fund*").

The Twentieth Supplemental Resolution creates the following special trust funds to be held by the Trustee:

- (i) Louisiana State University and Agricultural and Mechanical College Auxiliary Revenue and Refunding Bonds, Series 2022 Bond Proceeds Fund (the "*Series 2022 Bond Proceeds Fund*");
- (ii) Series 2022 Costs of Issuance Account, to be held within the Series 2022 Bond Proceeds Fund; and
- (iv) Series 2022 Principal Account and Series 2022 Interest Account.

Moneys in all such funds and accounts may only be invested in Permitted Investments. See "**APPENDIX D - DEFINITIONS OF CERTAIN TERMS - Permitted Investments.**"

Series 2022 Bond Proceeds Fund. The Series 2022 Bond Proceeds Fund shall be maintained with the Trustee and used to receive the proceeds of the Series 2022 Bonds; all to be transferred to the various Funds and Accounts or paid in the amounts specified in the Bond Resolution and as shall be specified in the request and authorization delivered pursuant to the Bond Resolution.

Series 2022 Costs of Issuance Account of the Series 2022 Bond Proceeds Fund. Moneys in the Series 2022 Costs of Issuance Account will be applied by the Trustee to pay, upon the written order of an Authorized Representative, or otherwise upon the receipt of a Requisition (2022 Costs of Issuance) amounts of expenses certified in such request which are fees and expenses incurred or to be incurred in connection with or incident to the issuance and sale of the Series 2022 Bonds. Upon the earlier of (i) one hundred eighty (180) days following the date of issuance of the Series 2022 Bonds, or (ii) receipt of the written direction of an Authorized Board Representative stating that all the Series 2022 Costs of Issuance have been paid, the Trustee will transfer any amounts remaining in the Series 2022 Costs of Issuance Account, including the earnings thereon, to the Series 2022 Interest Account.

Series 2022 Interest Account and Series 2022 Principal Account. There shall be deposited into the Series 2022 Interest Account and the Series 2022 Principal Account, as appropriate, and as and when received (a) all payments pursuant to Pledge of Auxiliary Revenues Article of the Twentieth Supplemental Resolution and any payments on the Series 2022 Bonds, (b) all moneys transferred to the Series 2022 Interest Account and Series 2022 Interest Account from the Series 2022 Costs of Issuance Account pursuant to the Twentieth Supplemental Resolution, (c) all other moneys required or permitted to be deposited into the Series 2022 Interest Account or Series 2022 Principal Account pursuant to the Twentieth Supplemental Resolution, including any supplements or amendments thereto and (iv) all other moneys received by the

Trustee when accompanied by directions not inconsistent with the Twentieth Supplemental Resolution that such moneys are to be paid into the Series 2022 Principal Account or Series 2022 Interest Account. There shall also be retained in the Series 2022 Principal Account or Series 2022 Interest Account, respectively, interest and other income received on investment of moneys in the Series 2022 Principal Account and Series 2022 Interest Account to the extent provided in the Twentieth Supplemental Resolution. If the Trustee does not receive payments into the Series 2022 Principal Account and Series 2022 Interest Account, pursuant to the Twentieth Supplemental Resolution when due, the Trustee will immediately notify the Board of such nonpayment. The Board shall receive a credit against the Board's obligation to make deposits in the Series 2022 Principal Account and Series 2022 Interest Account to the extent of interest earnings on moneys in the Series 2022 Principal Account or Series 2022 Interest Account.

Investments and Earnings on Certain Funds and Accounts and Valuation Thereof. The amounts on deposit in the Funds and Accounts created by the Twentieth Supplemental Resolution shall be invested by the Trustee in Permitted Investments, as defined in the Twentieth Supplemental Resolution, in accordance with written directions signed by an Authorized Board Representative, and notwithstanding any provision of the General Bond Resolution to the contrary, earnings on the amounts held in the Series 2022 Interest Account and the Series 2022 Principal Account shall be retained therein. Any provisions of the General Bond Resolution to the contrary notwithstanding, for the purpose of determining the amount in any Fund or Account, all Permitted Investments credited to such Fund or Account shall be valued at fair market value. Except as otherwise described in this paragraph, the Trustee shall determine the fair market value based on accepted industry standards and from accepted industry providers. Certificates of deposit shall be valued at the face amount thereof plus accrued interest. Other investments not specified in this paragraph shall be valued in accordance with the value established by prior agreement between the Board and the Trustee.

Events of Default and Remedies

A default in the due and punctual payment of any interest on any Series 2022 Bond and default in the due and punctual payment of the principal of any Series 2022 Bond, whether at maturity or upon call for redemption, constitutes an Event of Default under the Bond Resolution. In addition, there are numerous other events set forth in the Bond Resolution, including, but not limited to, the Board's failure to comply with certain other covenants, agreements or conditions contained in the Bond Resolution which, if not remedied in a timely manner, can result in an Event of Default under the Bond Resolution. Upon the occurrence of an Event of Default, the Bond Resolution provides that the Trustee shall, but only with the consent or at the direction of all Credit Facility Providers, by notice in writing given to the Board, declare the principal amount of all Series 2022 Bonds then outstanding and the interest accrued thereon to be immediately due and payable. See "**BONDHOLDER'S RISKS - Difficulties in Enforcing Rights and Remedies**" herein and "**SUMMARY OF CERTAIN PROVISIONS OF THE BOND RESOLUTION - Events of Default and Remedies**" in **APPENDIX E** hereto for a complete description of Events of Default under the Bond Resolution and, subject to conditions and limitations described therein, the rights and remedies available to the Trustee and the holders of the Series 2022 Bonds upon the occurrence of an Event of Default thereunder.

FUTURE FINANCING PLANS

The University implemented a Comprehensive Housing plan in 2002 (updated in 2014) and a campus master plan in 2003 projecting capital expenditures for projects throughout the campus. Funding for these projects is expected from various sources, including funding from the State, from the issuance of auxiliary revenue bonds and or subordinate lease obligations payable from Auxiliary Revenues.

Three of the four phases of the Development have been financed, and the Board expects to incur additional Subordinated Debt in the form of subordinate lease obligations at some point in the future to

finance the fourth phase of the Development; however, the Board is currently evaluating enrollment trends and cannot, at this time, predict when the fourth phase of the Development will take place.

There can be no assurance that, as its needs dictate, the Board will not modify current plans, which may reduce or increase the principal amount of the Bonds and or Subordinated Debt which may be issued.

BONDHOLDERS' RISKS

Purchasers of the Series 2022 Bonds are advised of certain risk factors with respect to the ability of the Board to pay the principal of and interest on the Series 2022 Bonds.

THE FUTURE AVAILABILITY OF AUXILIARY REVENUES IS DEPENDENT UPON THE CONTINUED OPERATION OF THE UNIVERSITY, WHICH IS PRIMARILY FUNDED BY STUDENT TUITION AND FEES AND STATE APPROPRIATIONS WHICH ARE NOT PLEDGED TO, NOR AVAILABLE FOR, THE PAYMENT OF THE SERIES 2022 BONDS. THEREFORE, THE ABILITY OF THE UNIVERSITY TO MAKE PRINCIPAL AND INTEREST PAYMENTS ON THE SERIES 2022 BONDS IS INDIRECTLY CONTINGENT UPON SUFFICIENT ANNUAL STATE APPROPRIATIONS AND COLLECTION OF STUDENT TUITION AND FEES TO CONTINUE THE OPERATIONS OF THE UNIVERSITY.

[TO BE UPDATED]

TAX MATTERS

General Matters

Bond Counsel is of the opinion that interest on the Series 2022 Bonds is included in gross income for federal income tax purposes.

It is further the opinion of Bond Counsel that, pursuant to the Refunding Act, the Series 2022 Bonds and the income therefrom shall be exempt from all taxation by the State or any political subdivision thereof. Bond Counsel has expressed no opinion regarding other tax consequences arising with respect to the Series 2022 Bonds under the laws of the State of Louisiana or any other state or jurisdiction.

The following is a summary of certain anticipated federal income tax consequences of the purchase, ownership and disposition of the Series 2022 Bonds under the Code and the Regulations, and the judicial and administrative rulings and court decisions now in effect, all of which are subject to change or possible differing interpretations. The summary does not purport to address all aspects of federal income taxation that may affect particular investors in light of their individual circumstances, nor certain types of investors subject to special treatment under the federal income tax laws. Potential purchasers of the Series 2022 Bonds should consult their own tax advisors in determining the federal, state or local tax consequences to them of the purchase, holding and disposition of the Series 2022 Bonds.

In general, interest paid on the Series 2022 Bonds, original issue discount, if any, and market discount, if any, will be treated as ordinary income to the owners of the Series 2022 Bonds, and principal payments (excluding the portion of such payments, if any, characterized as original issue discount or accrued market discount) will be treated as a return of capital.

Except as stated above, Bond Counsel will express no opinion as to any federal, State or local tax consequences resulting from the ownership of, receipt of interest on or disposition of the Series 2022 Bonds.

Market Discount; Original Issue Discount*

An investor that acquires a Series 2022 Bond for a price less than the adjusted issue price of such bond (or an investor who purchases a Series 2022 Bond in the initial offering at a price less than the issue price) may be subject to the market discount rules of Sections 1276 through 1278 of the Code. Under these sections and the principles applied by the Regulations, "market discount" means (a) in the case of a Series 2022 Bond originally issued at a discount, the amount by which the issue price of such bond, increased by all accrued original issue discount (as if held since the issue date), exceeds the initial tax basis of the owner therein, less any prior payments that did not constitute payments of qualified stated interest, and (b) in the case of a Series 2022 Bond not originally issued at a discount, the amount by which the stated redemption price of such bond at maturity exceeds the initial tax basis of the owner therein. Under Section 1276 of the Code, the owner of such a Series 2022 Bond will generally be required (i) to allocate each principal payment to accrued market discount not previously included in income and, upon sale or other disposition of the bond, to recognize the gain on such sale or disposition as ordinary income to the extent of such cumulative amount of accrued market discount as of the date of sale or other disposition of such a bond or (ii) to elect to include such market discount in income currently as it accrues on all market discount instruments acquired by such owner on or after the first day of the taxable year to which such election applies.

The Code authorizes the Treasury Department to issue regulations providing for the method for accruing market discount on debt instruments the principal of which is payable in more than one installment. Until such time as regulations are issued by the Treasury Department, certain rules described in the legislative history will apply. Under those rules, market discount will be included in income either (a) on a constant interest basis or (b) in proportion to the accrual of stated interest or, in the case of a Series 2022 Bond with original issue discount, in proportion to the accrual of original issue discount.

An owner of a Series 2022 Bond that acquired such bond at a market discount also may be required to defer, until the maturity date of such bond or its earlier disposition in a taxable transaction, the deduction of a portion of the amount of interest that the owner paid or accrued during the taxable year on indebtedness incurred or maintained to purchase or carry such bond in excess of the aggregate amount of interest (including original issue discount) includable in such owner's gross income for the taxable year with respect to such bond. The amount of such net interest expense deferred in a taxable year may not exceed the amount of market discount accrued on the Series 2022 Bond for the days during the taxable year on which the owner held such bond and, in general, would be deductible when such market discount is includable in income. The amount of any remaining deferred deduction is to be taken into account in the taxable year in which the Series 2022 Bond matures or is disposed of in a taxable transaction. In the case of a disposition in which gain or loss is not recognized in whole or in part, any remaining deferred deduction will be allowed to the extent gain is recognized on the disposition. This deferral rule does not apply if the owner elects to include such market discount in income currently as it accrues on all market discount obligations acquired by such owner in that taxable year or thereafter.

Attention is called to the fact that Regulations implementing the market discount rules have not yet been issued. Therefore, investors should consult their own tax advisors regarding the application of these rules as well as the advisability of making any of the elections with respect thereto.

Unearned Income Medicare Contribution Tax

Pursuant to Section 1411 of the Code, as enacted by the Health Care and Education Reconciliation Act of 2010, an additional tax is imposed on individuals earning certain investment income. Holders of the

* Preliminary, subject to change.

Series 2022 Bonds should consult their own tax advisors regarding the application of this tax to interest earned on the Series 2022 Bonds and to gain on the sale of a Series 2022 Bond.

Sales of Other Dispositions

If an owner of a Series 2022 Bond sells the bond, such person will recognize gain or loss equal to the difference between the amount realized on such sale and such owner's basis in such bond. Ordinarily, such gain or loss will be treated as a capital gain or loss.

If the terms of a Series 2022 Bond were materially modified, in certain circumstances, a new debt obligation would be deemed created and exchanged for the prior obligation in a taxable transaction. Among the modifications that may be treated as material are those that relate to redemption provisions and, in the case of a nonrecourse obligation, those which involve the substitution of collateral. Each potential owner of a Series 2022 Bond should consult its own tax advisor concerning the circumstances in which such bond would be deemed reissued and the likely effects, if any, of such reissuance.

Defeasance

The legal defeasance of the Series 2022 Bonds may result in a deemed sale or exchange of such bonds under certain circumstances. Owners of such Series 2022 Bonds should consult their tax advisors as to the federal income tax consequences of such a defeasance.

Backup Withholding

An owner of a Series 2022 Bond may be subject to backup withholding at the applicable rate determined by statute with respect to interest paid with respect to the Series 2022 Bonds, if such owner, upon issuance of the Bonds, fails to provide to any person required to collect such information pursuant to Section 6049 of the Code with such owner's taxpayer identification number, furnishes an incorrect taxpayer identification number, fails to report interest, dividends or other "reportable payments" (as defined in the Code) properly, or, under certain circumstances, fails to provide such persons with a certified statement, under penalty of perjury, that such owner is not subject to backup withholding.

Foreign Investors

An owner of a Series 2022 Bond that is not a "United States person" (as defined below) and is not subject to federal income tax as a result of any direct or indirect connection to the United States of America in addition to its ownership of a Series 2022 Bond will generally not be subject to United States income or withholding tax in respect of a payment on a Series 2022 Bond, provided that the owner complies to the extent necessary with certain identification requirements (including delivery of a statement, signed by the owner under penalties of perjury, certifying that such owner is not a United States person and providing the name and address of such owner). For this purpose the term "*United States person*" means a citizen or resident of the United States of America, a corporation, partnership or other entity created or organized in or under the laws of the United States of America or any political subdivision thereof, or an estate or trust whose income from sources within the United States of America is includable in gross income for United States of America income tax purposes regardless of its connection with the conduct of a trade or business within the United States of America.

Except as explained in the preceding paragraph and subject to the provisions of any applicable tax treaty, a 30 percent United States withholding tax will apply to interest paid and original issue discount accruing on Series 2022 Bonds owned by foreign investors. In those instances in which payments of interest on the Series 2022 Bonds continue to be subject to withholding, special rules apply with respect to the withholding of tax on payments of interest on, or the sale or exchange of Series 2022 Bonds having original

issue discount and held by foreign investors. Potential investors that are foreign persons should consult their own tax advisors regarding the specific tax consequences to them of owning a Series 2022 Bond.

Tax-Exempt Investors

In general, an entity that is exempt from federal income tax under the provisions of Section 501 of the Code is subject to tax on its unrelated business taxable income. An unrelated trade or business is any trade or business that is not substantially related to the purpose that forms the basis for such entity's exemption. However, under the provisions of Section 512 of the Code, interest may be excluded from the calculation of unrelated business taxable income unless the obligation that gave rise to such interest is subject to acquisition indebtedness. Therefore, except to the extent any owner of a Series 2022 Bond incurs acquisition indebtedness with respect to such bond, interest paid or accrued with respect to such owner may be excluded by such tax-exempt owner from the calculation of unrelated business taxable income. Each potential tax-exempt holder of a Series 2022 Bond is urged to consult its own tax advisor regarding the application of these provisions.

ERISA Considerations

The Employee Retirement Income Security Act of 1974, as amended ("*ERISA*"), imposes certain requirements on "employee benefit plans" (as defined in Section 3(3) of ERISA) subject to ERISA, including entities such as collective investment funds and separate accounts whose underlying assets include the assets of such plans (collectively, "*ERISA Plans*") and on those persons who are fiduciaries with respect to ERISA Plans. Investments by ERISA Plans are subject to ERISA's general fiduciary requirements, including the requirement of investment prudence and diversification and the requirement that an ERISA Plan's investments be made in accordance with the documents governing the ERISA Plan. The prudence of any investment by an ERISA Plan in the Series 2022 Bonds must be determined by the responsible fiduciary of the ERISA Plan by taking into account the ERISA Plan's particular circumstances and all of the facts and circumstances of the investment. Government and non-electing church plans are generally not subject to ERISA. However, such plans may be subject to similar or other restrictions under state or local law.

In addition, ERISA and the Code generally prohibit certain transactions between an ERISA Plan or a qualified employee benefit plan under the Code and persons who, with respect to that plan, are fiduciaries or other "parties in interest" within the meaning of ERISA or "disqualified persons" within the meaning of the Code. In the absence of an applicable statutory, class or administrative exemption, transactions between an ERISA Plan and a party in interest with respect to an ERISA Plan, including the acquisition by one from the other of the Series 2022 Bonds could be viewed as violating those prohibitions. In addition, Section 4975 of the Code prohibits transactions between certain tax-favored vehicles such as Individual Retirement Accounts and disqualified persons. Section 503 of the Code includes similar restrictions with respect to governmental and church plans. In this regard, the Board or any dealer of the Series 2022 Bonds might be considered or might become a "party in interest" within the meaning of ERISA or a "disqualified person" within the meaning of the Code, with respect to an ERISA Plan or a plan or arrangement subject to Sections 4975 or 503 of the Code. Prohibited transactions within the meaning of ERISA and the Code may arise if the Series 2022 Bonds are acquired by such plans or arrangements with respect to which the Board or any dealer is a party in interest or disqualified person.

In all events, fiduciaries of ERISA Plans and plans or arrangements subject to the above sections of the Code, in consultation with their advisors, should carefully consider the impact of ERISA and the Code on an investment in the Series 2022 Bonds. The sale of the Series 2022 Bonds to a plan is in no respect a representation by the Board or the Underwriter that such an investment meets the relevant legal requirements with respect to benefit plans generally or any particular plan. Any plan proposing to invest in the Series 2022 Bonds should consult with its counsel to confirm that such investment is permitted under

the plan documents and will not result in a non-exempt prohibited transaction and will satisfy the other requirements of ERISA, the Code and other applicable law.

Changes in Federal and State Tax Law

From time to time, there are legislative proposals in the Congress and in the states that, if enacted, could alter or amend the federal and state tax matters referred to under this heading "**TAX MATTERS**" or adversely affect the market value of the Series 2022 Bonds. It cannot be predicted whether or in what form any such proposal might be enacted or whether if enacted it would apply to bonds issued prior to enactment. In addition, regulatory actions are from time to time announced or proposed and litigation is threatened or commenced which, if implemented or concluded in a particular manner, could adversely affect the market value of the Series 2022 Bonds. It cannot be predicted whether any such regulatory action will be implemented, how any particular litigation or judicial action will be resolved, or whether the Series 2022 Bonds or the market value thereof would be impacted thereby. Purchasers of the Series 2022 Bonds should consult their tax advisors regarding any pending or proposed legislation, regulatory initiatives or litigation. The opinions expressed by Bond Counsel are based on existing legislation and regulations as interpreted by relevant judicial and regulatory authorities as of the date of issuance and delivery of the Series 2022 Bonds, and Bond Counsel has expressed no opinion as of any date subsequent thereto or with respect to any pending legislation, regulatory initiatives or litigation.

PROSPECTIVE PURCHASERS OF THE SERIES 2022 BONDS ARE ADVISED TO CONSULT THEIR OWN TAX ADVISORS PRIOR TO ANY PURCHASE OF THE SERIES 2022 BONDS AS TO THE IMPACT OF THE CODE UPON THEIR ACQUISITION, HOLDING OR DISPOSITION OF THE SERIES 2022 BONDS.

RATINGS

Moody's Investors Service, Inc. and Fitch Ratings have assigned ratings of "___" (_____ Outlook) and "___" (_____ Outlook), respectively, to the Series 2022 Bonds.

Such ratings reflect only the view of such organizations and any desired explanation of the significance of such ratings should be obtained from Moody's Investors Service, Inc., 7 World Trade Center, 250 Greenwich Street, New York, New York 10007; and Fitch Ratings, 33 Whitehall Street, New York, New York 10004. Generally, a rating agency bases its rating on the information and materials furnished to it and on investigations, studies and assumptions of its own. There is no assurance such ratings will continue for any given period of time or that such ratings will not be revised downward or withdrawn entirely by the rating agencies, if in the judgment of such rating agencies, circumstances so warrant. Any such downward revision or withdrawal of such ratings may have an adverse effect on the market price of the Series 2022 Bonds.

The Board has not requested any other organization to consider the assignment of a rating for the Series 2022 Bonds.

Neither the Board nor the Underwriter has undertaken the responsibility of taking any action with respect to possible changes in such ratings or of bringing any such changes to the attention of the owners of the Series 2022 Bonds. See, however, "**CONTINUING DISCLOSURE**" herein and "**FORM OF CONTINUING DISCLOSURE CERTIFICATE**" in **APPENDIX F** hereto with respect to the obligation of the Board to provide notice of certain material events, including, without limitation, rating changes.

LEGAL MATTERS

Certain legal matters incident to the authorization, issuance and validity of the Series 2022 Bonds are subject to the approval of Breazeale, Sachse & Wilson, L.L.P., Baton Rouge, Louisiana, Bond Counsel, a copy of whose approving opinion will be printed on the Series 2022 Bonds and the proposed form of which is included in **APPENDIX C**. Certain other legal matters will be passed upon for the Board by its counsel, Breazeale, Sachse & Wilson, L.L.P., Baton Rouge, Louisiana, and for the Trustee and the Escrow Trustee by its counsel, Gregory A. Pletsch & Associates, Baton Rouge, Louisiana. In addition, certain legal matters will be passed upon for the Underwriter by its counsel, Foley & Judell, L.L.P., New Orleans, Louisiana.

Bond Counsel has been engaged primarily for the purpose of reviewing the transcript of proceedings by which the Series 2022 Bonds have been authorized to be issued and rendering opinions as to the validity and enforceability of the Series 2022 Bonds.

None of the legal counsel referenced in this Official Statement has (a) participated in the underwriting of the Series 2022 Bonds, (b) provided any advice regarding the creditworthiness of the Bonds, or (c) assisted in determining the value of the collateral for the Series 2022 Bonds upon the occurrence of an event of default. Legal counsel will have solely and exclusively opined to those matters which are expressly set forth in their respective opinions which will be delivered simultaneously with the delivery of the Series 2022 Bonds and no holder of a Series 2022 Bond shall be authorized or entitled to infer that such legal counsel have rendered opinions beyond those stated in their written opinions or to rely on the participation of counsel in this transaction. Except for negligent errors in their express written opinions, legal counsel shall have no obligations to holders of the Series 2022 Bonds and holders of the Series 2022 Bonds must not rely either expressly or implicitly upon such counsel in determining whether the Series 2022 Bonds represent suitable investments or otherwise meet their creditworthiness and risk tolerance standards.

LITIGATION

There are no legal proceedings or litigation now pending or, to the knowledge of the Board, threatened against the Board which restrain or enjoin the issuance or delivery of the Series 2022 Bonds or question or affect the legality of the Series 2022 Bonds or the proceedings and authority under which the Series 2022 Bonds are issued.

UNDERWRITING

The Series 2022 Bonds are being purchased for reoffering by Raymond James & Associates, Inc. (the "*Underwriter*"), pursuant to a Bond Purchase Agreement. The Series 2022 Bonds are being purchased at an aggregate purchase price of \$_____ (representing \$_____ original principal amount, less \$_____ of Underwriter's discount). The Bond Purchase Agreement requires the Underwriter to purchase all of the Series 2022 Bonds if any are purchased.

The Underwriter intends to offer the Series 2022 Bonds to the public initially at the prices set forth on the cover page of this Official Statement, which may subsequently change without any requirement of prior notice. The Underwriter reserves the right to join with dealers and other underwriters in offering the Series 2022 Bonds to the public. The Underwriter may offer and sell the Series 2022 Bonds to certain dealers at prices lower than the public offering prices. In connection with this offering, the Underwriter may overallocate or effect transactions which stabilize or maintain the market price of the Series 2022 Bonds offered hereby at a level above that which might otherwise prevail in the open market. Such stabilizing, if commenced, may be discontinued at any time.

Raymond James may also receive compensation for serving as bidding agent in conducting a competitive bid for the investment of some or all of the proceeds of the Series 2022 Bonds.

VERIFICATION OF COMPUTATIONS

The arithmetical accuracy of certain computations included in the schedules provided by the Underwriter on behalf of the Board relating to (a) computation of anticipated receipts of principal and interest on the Defeasance Obligations referred to under "**PLAN OF FINANCE**" and the anticipated payments of principal and interest to redeem and/or defease the Refunded Bonds, and (b) computation of the yields on the Series 2022 Bonds and the Defeasance Obligations was examined by Causey Demgen & Moore P.C. Such computations were based solely upon assumptions and information supplied by the Underwriter on behalf of the Board. Causey Demgen & Moore P.C. has restricted its procedures to examining the arithmetical accuracy of certain computations and has not made any study or evaluation of the assumptions and information upon which the computations are based and, accordingly, has not expressed an opinion on the data used, the reasonableness of the assumptions, or the achievability of future events.

CERTIFICATION AS TO OFFICIAL STATEMENT

At the time of payment for and delivery of the Series 2022 Bonds, the Board will furnish the Underwriter a certificate signed by the Chairman and Secretary of the Board to the effect that (i) the descriptions and statements, including financial data, of or pertaining to the Board on the date of the Official Statement, on the date of the sale of the Series 2022 Bonds and on the date of the delivery thereof, were and are true in all material respects, and, insofar as such matters are concerned, the Official Statement did not and does not contain an untrue statement of a material fact or omit to state a material fact required to be stated therein or necessary to make the statements therein, in light of the circumstances under which they were made, not misleading, (ii) insofar as the descriptions and statements, including financial data, of or pertaining to governmental and/or non-governmental entities other than the Board and their activities contained in the Official Statement are concerned, such descriptions, statements, and data have been obtained from sources which the Board believes to be reliable and the Board has no reason to believe that they are untrue or incomplete in any material respect, and (iii) there has been no adverse material change in the affairs of the Board between the date the Preliminary Official Statement was deemed final by the Board and the date of delivery of the Series 2022 Bonds.

CONTINUING DISCLOSURE

The Board will enter into an undertaking (the "*Undertaking*") for the benefit of the owners of the Series 2022 Bonds to provide, so long as the Series 2022 Bonds are outstanding and so long as required by the hereinafter defined Rule, certain financial information, operating data and notice of events, pursuant to the requirements of Section (b)(5)(i) of Securities and Exchange Commission Rule 15c2-12 (17 C.F.R. Part 240, §240.15c2-12) (the "*Rule*"). See "**FORM OF CONTINUING DISCLOSURE CERTIFICATE**" in **APPENDIX F** hereto.

A failure by the Board to comply with the Undertaking will not constitute an Event of Default under the Bond Resolution (although Bondholders will have any available remedy at law or in equity). Nevertheless, such a failure must be reported in accordance with the Rule and must be considered by a broker-dealer or municipal securities dealer before recommending the purchase or sale of the Series 2022 Bonds in the secondary market. Consequently, such a failure may adversely affect the transferability and liquidity of the Series 2022 Bonds and their market price.

Because the Board's audited financial statements are typically not available until after March 31 of each year, the Board's undertaking in connection with the Series 2022 Bonds will be due on April 30 of

each year, and the Board has amended certain prior undertakings to change the due date to April 30 of each year. The Board has implemented internal and external procedures to ensure timely compliance with its undertakings in the future.

Pursuant to its prior undertakings, the Board is required to file its audited financial statements ("*Audited Financial Statements*") and annual financial information and operating data ("*Operating Data*") relating to the immediately preceding fiscal year (which ends June 30) no later than April 30 of each year.

[TO BE UPDATED – With respect to fiscal year 2016, the Board filed its Audited Financing Statements and certain Operating Data timely on January 31, 2017, however, the Board inadvertently omitted certain information from its Operating Data. That information and a notice of late filing were filed on July 31, 2017. Furthermore, one or more of the Board's past filings may not have been filed under all outstanding CUSIPs and may have been misfiled under the wrong CUSIP or under the wrong category within the CUSIP. The Board has, however, attempted to cure these late or incomplete filings.]

From time to time the Board has issued auxiliary revenue bonds or entered into capital leases in connection with the issuance of municipal bonds for the purpose of financing capital projects for its other campuses or facilities under its control located in New Orleans, Eunice, Bogalusa and Alexandria, Louisiana (the "*Other Campuses*"). Each of such series of bonds or capital lease is issued or entered into pursuant to a different bond resolution or other approving resolution of the Board, as applicable, and is secured by a pledge of revenues of an Other Campus, the source of which is separate and distinct and unrelated to the Auxiliary Revenues of the University which will be used to pay debt service on the Series 2022 Bonds. In connection with each Other Campus bond issue or capital lease to which the Rule applies, the Board, on behalf of each Other Campus, has entered into a separate undertaking pursuant to the Rule. In certain prior instances during the past five years, certain required filings under the continuing disclosure agreements for Other Campuses were either late or incomplete. However, the Board, as the "obligated person" under the Rule with respect to the revenue bond issues benefitting the Other Campuses, has determined that providing continuing compliance information with respect to revenue bonds of such Other Campuses is not necessary or material to the holders of the Series 2022 Bonds. The Board has, however, attempted to cure late or incomplete filings relating to the Other Campuses.

The foregoing description of instances of noncompliance by the Board with continuing disclosure undertakings should not be construed as an acknowledgment that any such instance was material.

The Board has established procedures with respect to all undertakings (including those in connection with the Series 2022 Bonds), to ensure proper filing of such reports with the MSRB in the future. These remedial procedures include the establishment of an MSRB/EMMA tickler system with the University's Associate Vice President for Accounting Services and Assistant Vice President for Accounting Services for timely filing reminders.

Furthermore, Louisiana law provides additional procedures designed to ensure compliance with the Continuing Disclosure Certificate by (i) requiring public entities, such as the Board, to keep certain records demonstrating compliance with the Continuing Disclosure Certificate; and (ii) mandating the Board's auditor, as part of the preparation of the Board's annual financial audit, review the Board's compliance with its continuing disclosure undertakings and record keeping requirements. Such legislation became effective on August 1, 2014.

MISCELLANEOUS

The information set forth herein has been obtained from Board records and other sources which are considered reliable. There is no guarantee that any of the assumptions or estimates contained herein will ever be realized. All of the summaries of the statutes, documents and resolutions contained in this Official Statement are made subject to all of the provisions of such statutes, documents and resolutions. These summaries do not purport to be complete statements of such provisions, and reference is made to such documents for further information. Reference is made to official documents in all respects. Any statement in this Official Statement involving any matter of opinion, whether or not expressly so stated, is intended as such and not as a representation of fact. No representation is made that any such opinion will actually be borne out. This Official Statement is not to be construed as a contract or agreement between the Board or the Underwriter and the purchasers or Registered Owners of any of the Series 2022 Bonds. Prospective purchasers of the Series 2022 Bonds are also cautioned that the accuracy of any statistical, demographic or economic projection or analysis contained herein is not guaranteed and therefore investors are urged to consult their own advisors concerning such projections or analysis.

The Board has duly authorized and directed the delivery of this Official Statement to the Underwriter for use in connection with the public offering of the Series 2022 Bonds.

BOARD OF SUPERVISORS OF LOUISIANA
STATE UNIVERSITY AND AGRICULTURAL
AND MECHANICAL COLLEGE

By: _____
Title: Interim Executive Vice President for
Finance and Administration/CFO,
Louisiana State University

APPENDIX A

**DEMOGRAPHIC AND SUMMARY FINANCIAL
INFORMATION RELATED TO THE UNIVERSITY**

DEMOGRAPHIC INFORMATION

ENROLLMENT

The following table reflects the fall semester head count enrollment at the University.

UNIVERSITY ENROLLMENT FALL 2016 THROUGH FALL 2020

	2016	2017	2018	2019	2020
Undergraduate	26,123	25,446	25,363	25,920	27,948
Graduate and Professional	5,291	5,417	5,624	5,841	6,342
Total	31,414	30,863	30,987	31,761	34,290

Source: University

The following table reflects the applications, admissions and matriculations of new freshmen and transfers at the University for the fall semesters.

NEW FRESHMEN AND TRANSFER APPLICATION STATISTICS OF UNIVERSITY FALL 2011 THROUGH FALL 2020

FALL SEMESTER	APPLICATIONS TOTALS	ADMISSIONS TOTALS	MATRICULATION TOTALS
2011	17,141	13,135	6,085
2012	18,652	13,710	6,550
2013	18,395	13,360	6,367
2014	19,083	14,152	6,555
2015	20,161	15,093	6,670
2016	20,412	15,198	6,259
2017	20,005	14,521	5,620
2018	26,089	19,258	6,539
2019	26,447	19,616	6,850
2020	31,885	23,074	7,629

Source: University

[Remainder of Page Intentionally Left Blank]

The following table reflects percentages of fall semester freshmen classes at the University returning in the fall of the second through sixth years.

**RETENTION RATES OF NEW FRESHMEN CLASS OF UNIVERSITY
FALL 2010 THROUGH FALL 2019**

Fall Semester	# of New Freshmen	% Returning Fall of Second Year	% Returning Fall of Third Year	% Returning Fall of Fourth Year	% Returning Fall of Fifth Year	% Returning Fall of Sixth Year
2010	5,475	83.8%	75.1%	69.8%	30.0%	8.1%
2011	5,278	83.0%	73.0%	68.0%	30.1%	7.9%
2012	5,717	82.5%	73.2%	67.6%	28.1%	6.6%
2013	5,498	84.6%	75.5%	69.3%	27.6%	6.8%
2014	5,652	84.7%	74.3%	68.2%	28.8%	7.1%
2015	5,619	82.8%	72.7%	67.4%	25.3%	5.9%
2016	5,470	82.9%	73.4%	67.8%	24.8%	n/a
2017	4,910	83.7%	74.5%	69.2%	n/a	n/a
2018	5,809	83.0%	74.8%	n/a	n/a	n/a
2019	6,126	85.8%	n/a	n/a	n/a	n/a

Source: University

The following table reflects the cumulative percentage of new freshmen for the fall semesters at the University graduating after 4, 5 and 6 years.

**GRADUATION RATES OF NEW FRESHMEN CLASS OF UNIVERSITY
FALL 2011 THROUGH FALL 2020**

Fall Semester	# of New Freshmen	Cumulative % Graduating after 4 Years	Cumulative % Graduating after 5 Years	Cumulative % Graduating after 6 Years
2011	5,278	38.0%	59.3%	64.2%
2012	5,717	38.8%	59.8%	64.0%
2013	5,498	41.0%	60.9%	65.3%
2014	5,652	39.4%	61.0%	65.7%
2015	5,619	42.9%	61.9%	n/a
2016	5,470	44.1%	n/a	n/a
2017	4,910	n/a	n/a	n/a
2018	5,809	n/a	n/a	n/a
2019	6,126	n/a	n/a	n/a
2020	6,690	n/a	n/a	n/a

Source: University

TUITION AND FEES

Tuition and fees account for approximately 41.7% of the total current revenue budget of the University. Tuition and fees are set by the Board. The following table reflects the annual tuition and required fees of full-time resident and nonresident undergraduate students of the University.

**ANNUAL TUITION AND REQUIRED FEES
FULL-TIME UNDERGRADUATE STUDENTS OF UNIVERSITY
ACADEMIC YEARS 2012 THROUGH 2021**

YEAR	RESIDENT	NONRESIDENT
2012	6,354	19,362
2013	6,989	22,265
2014	7,873	25,790
2015	8,750	26,467
2016	9,842	27,005
2017	10,814	27,491
2018	11,374	28,051
2019	11,949	28,626
2020	11,962	28,639
2021	11,962	28,639

Source: University

[Remainder of Page Intentionally Left Blank]

HOUSING AND MEALS

Rates for University residence halls and undergraduate apartments range from approximately \$3,030 to \$4,405 per fall and spring semester. Summer term rates are one-half these amounts. Rents for University owned family/graduate student apartments range from approximately \$3,750 to \$7,290 per semester. Fraternity and sorority house rent and meals range from \$2,961 to \$4,750 per semester. The cost of dining plans range from approximately \$2,157 to \$2,348 during the fall and spring semesters and slightly less during the summer term.

The following table reflects the capacity, occupancy and percent of occupancy of the University residence halls and apartments for the fall semesters.

**RESIDENCE HALL AND APARTMENT OCCUPANCY
FALL 2016 THROUGH FALL 2020**

FALL SEMESTER	TYPE	CAPACITY	OCCUPANCY	% OCCUPANCY
2016*	Residence Hall	4,592	4,134	90.0%
	Apartments	1,315	1,270	96.6%
2017	Residence Hall	4,322	3,650	84.5%
	Apartments	1,306	1,271	97.3%
2018	Residence Hall	4,867	4,725	97.1%
	Apartments	2,800	2,093	74.8%
2019	Residence Hall	5,041	4,994	99.1%
	Apartments	2,820	2,682	95.1%
2020	Residence Hall	5,673	4,852	85.5%
	Apartments	2,795	2,204	78.9%

**Note: Starting in 2016, East and West Campus Apartments are included as "Apartments." Prior to 2016, they were included under "Residence Hall."*

Source: University

FACULTY AND STAFF

There are 1,477 faculty members at the University, 1,413 of which are full-time faculty members and 64 of which are part-time. Seventy-six percent (76%) of the faculty have doctoral degrees, and eighty-five percent (85%) of the faculty have terminal degrees. The student-faculty ratio is 22:1. Staff members total 3,689.

[Remainder of Page Intentionally Left Blank]

DEGREES

The University is accredited by the Southern Association of Colleges and Schools and offers 75 bachelor's degrees, 3 post-bachelor's certificates, 76 master's degrees, 52 doctoral degrees, 1 post-doctoral certificate, 1 education specialist, 3 professional degrees, 1 post-professional certificate, and 27 graduate school certificates.

Since its first commencement in 1869, the University has awarded over 291,000 degrees. The University produces about 25% of Louisiana's graduates with baccalaureate degrees; approximately 18% of the master's degrees; and about 60% of the doctoral degrees. In 2019-2020, the University awarded 4,971 Bachelor's degrees, 81 Post-Baccalaureate Certificates, 1,297 Master's degrees, 15 Education Specialist degrees, 347 Doctoral degrees, 88 degrees in Veterinary Medicine, 166 Professional degrees in Law, 11 Post-Professional Certificates in Law, and 104 Graduate Certificates for a total of 7,080 degrees awarded

FINANCIAL AID

During the 2019-2020 academic year, approximately 77% of the University's students received some form of financial aid. The total amount of this financial aid in the 2019-20 academic year was over \$430 million. Of this amount, 39% was derived from federal sources, 21% was derived from institutional sources, 15% was derived from private sources, and 24% was derived from state sources.

PRIVATE SUPPORT

The LSU Alumni Association, the LSU Foundation, and the Tiger Athletic Foundation actively seek support from the private sector to supplement State appropriations.

Alumni gifts generated through the association are used to support academic scholarships, alumni professorships, student jobs, faculty awards, and alumni programs, reunions, and publications. In calendar year 2019 the Alumni Association received more than \$4.33 million from alumni and friends.

Private giving through the LSU Foundation focuses on building its endowment for the University's benefit and on gifts designated for specific purposes in the colleges and schools within the University, including professorships, scholarships, library and museum acquisitions, equipment and facilities, distinguished faculty chairs and fellowships, and other purposes that cannot be supported entirely with State funds. In fiscal year 2020, the LSU Foundation received approximately \$32.44 million in cash contributions. The LSU Foundation's endowed funds were valued at approximately \$478.05 million at June 30, 2020.

The contributions to the Tiger Athletic Foundation benefit every athlete and team at LSU through scholarship and academic awards, as well as through the construction and maintenance of athletic facilities. For the calendar year 2019, the Tiger Athletic Foundation received over \$45.83 million in cash contributions.

COMPUTERS

The University maintains a state-of-the-art information technology environment supporting approximately 35,000 users involved in instructional, research and administrative computing. The University's technology infrastructure includes an enterprise server system to support administrative services, 3 high performance computing clusters, a 40 Gbps network with multiple Internet paths, content and learning management systems, over 195 multimedia/special purpose classrooms, a virtual lab environment, and secure Wi-Fi coverage for the campus.

Information technology facilities serving the campus include 4 computer labs housing more than 800 networked personal computers, workstations and supercomputing resources. Software resources available

to the LSU community include Microsoft and other commercial software products, as well as an extensive selection of open source packages distributed through a University Web-based software library.

LIBRARIES

The LSU Libraries provides resources to support the instructional and research programs of the University. The Libraries is a member of the Association of Research Libraries (ARL), which includes the top academic and research libraries in the U.S. and Canada. With holdings of 6.22 million volumes and annual expenditures of \$15.3 million, the LSU Libraries is comprised of the main collection located in LSU Library, the Special Collections in Hill Memorial Library, the Veterinary Medicine Library in the School of Veterinary Medicine, the Law Library in the Law Center, and the Cartographic Information Center in the Department of Geography and Anthropology. The LSU Libraries has been designated a regional depository for U.S. Government documents, a Patent/Trademark Depository, and a Louisiana documents depository. The Law Library is one of the finest in the U.S. Its foreign and comparative law collection has been described by the American Bar Association accreditation committee as a "national treasure".

Special Collections includes the Louisiana and Lower Mississippi Valley Collections (LLMVC), the Rare Book Collection, and the E.A. McIlhenny Natural History Collection, in addition to more than a dozen smaller specialized collections. Comprising the largest accumulation of materials on Louisiana and the lower Mississippi Valley in existence, LLMVC is an international center for researchers studying the region. Special strengths in other collections include natural history, especially ornithology and botany; 18th century British literature and history; and modern fine printing and book arts. Special Collections has contributed more than 58 collections of primary source materials to the Louisiana Digital Library and hundreds of thousands of historical Louisiana newspapers to *Chronicling America*, both of which are freely available to the public.

LSU Libraries was one of the founding library systems in the creation of LOUIS: the Louisiana Library Network, a partnership of public and private academic libraries in the State.

RESEARCH

As the Flagship Institution for the State, LSU is committed to its leadership in research, scholarship and creative activity. LSU faculty and researchers are at the forefront of developing new technology and programs, providing education and training for the State's population, and developing a new generation of leadership to take Louisiana forward in the 21st century.

Research is conducted by faculty in academic departments, research centers, institutes, and other specialized units. At any given time, more than 1,200 sponsored research projects are underway at the University. In addition, faculty members pursue numerous research projects that are not sponsored by outside agencies, as do many graduate students.

ATHLETICS

The University's athletic teams, the LSU Tigers, draw some of the largest crowds in all of college athletics. Sellout crowds are the norm at Tiger Stadium and the Tigers annually lead or rank among the nation's leaders in baseball attendance. The Pete Maravich Assembly Center accommodates large crowds for basketball, gymnastics, volleyball and other events.

The University offers intercollegiate sports programs for men and woman in 21 sports and is a charter member of the Southeastern Conference.

The University's athletic facilities include Tiger Stadium (seating 102,321 with 140 box suites, consisting of 7,200 club level seats), Bernie Moore Track Stadium (5,680), Alex Box Stadium (10,326), Pete Maravich

Assembly Center (13,215), the Carl Maddox Field House, Natatorium, LSU Soccer Stadium, LSU Tennis Complex, Tiger Softball Park and LSU Beach Volleyball Stadium.

LSU has competed among the nation's elite in the sports of baseball, softball, women's gymnastics, men's and women's track and field, beach volleyball, and men's and women's golf. The 2019 LSU football team won the CFP National Championship which is the school's third football national championship since 2003 and its fourth overall. With increased emphasis on women's athletics in the last decade, LSU is competitive across the board in the Southeastern Conference.

The University's athletic program has a national reputation for its facilities and operation. The Pete Maravich Assembly Center has been the site of the SEC Basketball Tournament and NCAA Regional Basketball and Gymnastics competitions. Alex Box Stadium has hosted the NCAA Baseball Regional and Super Regional Tournaments on numerous occasions. Bernie Moore Track Stadium has hosted the SEC and NCAA Outdoor Track and Field Championships.

[Remainder of Page Intentionally Left Blank]

SUMMARY FINANCIAL INFORMATION

OPERATING BUDGET AND STATE APPROPRIATIONS

Less than twenty five percent of the University's current unrestricted revenues are derived from State general fund appropriations. The constitution and statutes of the State require the Board of Regents to design a formula (the "Formula") providing for the distribution of State tax revenues to institutions of higher education. The Board of Regents is a constitutionally created board whose powers include budgetary responsibility for all public institutions of higher education.

The current Higher Education funding formula includes cost basis and outcome performance metrics. The overall distribution is divided between the cost and outcomes calculations to avoid dramatic swings in total funding between institutions. In subsequent years, the goal is to increase the proportion of total funding allocated to institutions utilizing the outcome metrics for each institution type. The recent revisions shifted a larger portion of the institutions' state funding to an outcomes based model with allocations driven by newly developed metrics. The cost component of the funding formula is built on policy driven calculations based on best practices used in other states. This formula was developed to give Louisiana a cost and outcomes based model that focuses on results, increasing numbers of degrees and certificates awarded, increasing research activity, and addressing workforce and economic development needs. Consistent funding and persistent use of the formula will allow institutions to predict their revenue streams based on campus outcome improvements and budget with a greater level of certainty.

The official budget request for postsecondary education, as envisioned by the state constitution and prescribed by law, outlines how the existing system should be supported. The formula serves as the representation of the funding level determined appropriate for providing adequate financial support for the operations of postsecondary institutions. The Board of Regents annually submits a request to the Division of Administration, Office of the Governor (the "Division"), and to the Legislature for full funding of the Formula.

The 2020 Legislature funded the Formula for FY 20-21 in the amount of \$112,907,991 in State General Funds for the Baton Rouge campus. This includes the LSU portion of the Coronavirus Aid, Relief, and Economic Security (CARES) Act Fund of \$5,361,800. Colleges and universities cannot itemize their budgets until the level of the Formula is established. Consequently, the Legislature appropriates lump sums to the managing boards of the various colleges and universities which then submit itemized budgets to the Board of Regents for review. These budgets are then transmitted to the Division and the Joint Legislative Committee on the Budget for consideration.

Self-generated revenues of public colleges and universities can be categorized as either restricted revenues or non-restricted revenues. All revenues are audited annually and reported in the audited financial statement of the University.

The following table reflects total State general fund appropriations to State higher education, to the LSU System campuses and to LSU. It also displays the ratio of State general fund appropriations to the LSU System as a percentage of total State general fund appropriations to State higher education; and total State general fund appropriations to the University as a percentage of total State general fund appropriations to the LSU System.

[Remainder of Page Intentionally Left Blank]

**UNIVERSITY STATE GENERAL FUND APPROPRIATION AND COMPARISON
2012 THROUGH 2021**

Fiscal Year	State Higher Education Total Appropriation		LSU System Total Appropriation	% of State	LSU Total Appropriation	% of System
2012	973,935,513		460,878,841	47.32	152,453,174	33.08
2013	861,394,800		387,626,503	45.00	132,464,883	34.17
2014	762,050,553		329,482,672	43.24	112,355,056	34.10
2015	738,771,377		316,942,421	42.90	107,149,958	33.81
2016	769,290,958	¹	373,477,242	48.55	114,492,041	30.66
2017	737,072,125		348,303,880	47.26	113,941,275	32.71
2018	738,009,329		350,527,829	47.50	115,513,766	32.95
2019	743,009,328		351,477,172	47.30	115,801,563	32.95
2020	769,082,834		361,575,925	47.01	115,968,824	32.07
2021	763,142,228	²	360,088,039	47.18	112,907,991	31.36

Source: University Operating Budget

The continued receipt of appropriations at current levels cannot be assured.

¹ In addition to the FY 2016 State General Fund Appropriations the Legislature appropriated the Higher Education Initiatives Fund as follows: State Higher Education Total Appropriation \$347,739,868; LSU System portion of Total State Appropriations \$168,821,596; and LSU portion of the LSU System Appropriation \$51,753,432. In FY 2016 the LSU campus was realigned to include the LSU System Administration and the LSU Law Center.

² In addition to the FY 2021 State General Fund Appropriations the Legislature appropriated the Coronavirus Aid, Relief, and Economic Security (CARES) Act Funds as follows: State Higher Education Total Appropriation \$99,921,118; LSU System portion of Total State Appropriations \$29,358,450; and LSU portion of the LSU System Appropriation \$5,361,800.

ENVIRONMENTAL RISK

Revenues and expenses of the University can be impacted by weather-related events. The University is located approximately 100 miles north of the Gulf of Mexico. The Gulf region is prone to seasonal hurricane activity; hurricanes or related storms may develop. Owing in part to its relatively flat topography and moist coastal climate, the University is subject to wind and other damage as a result of storm events and hurricanes.

The University has an emergency operations center that is activated when there exists the threat of a material weather-related event and, on such occasions, representatives from the administrative operating units of the University, including finance, residential life and LSU police, meet to ensure the University is safe-guarded and response time is minimal. In addition to internal response operations the University has strategic partnerships with the State’s emergency operations center and maintains a guaranteed priority response contract with a national disaster remediation company. The University is insured against weather-related events, including flood, by a robust property insurance program which provides for full replacement cost of property and loss of business income (subject to policy limits).

CYBERSECURITY RISK

A cybersecurity risk is the threat of violation to University networks or systems while an actual violation of University networks or systems is deemed a cybersecurity incident. Cybersecurity risks and incidents may arise from internal or external situations such as a virus outbreak, loss of a mobile device, hacking attempt, or network denial of service attack. Cybersecurity incidents could cause disruption to normal University operations and at worst could have a material adverse impact on the University's ability to operate. Proactively defending against cybersecurity risks and quickly responding to cybersecurity incidents is an important component of the University's overall security plan.

The technical response to cybersecurity incidents is managed by the University's Chief Information Security Officer and Information Technology Services. Technical cybersecurity defense and incident response activities are planned in advance for all University systems. To support response efforts the University purchases a cybersecurity and liability insurance policy which includes coverage for breach response and loss of business income. Cybersecurity training of system-users is conducted regularly to provide awareness and coordinated response effort. Designated response systems and procedures are subject to periodic technical testing. Finally, the University proactively develops cybersecurity response measures to address evolving cybersecurity threats.

COVID-19 DISCLOSURE

Beginning in the Spring 2020 academic semester, LSU's (herein referred to as "University") delivery of educational, medical, agricultural, athletics and other services and activities was impacted because of the stay-at-home and social distancing orders associated with the COVID-19 public health emergency. COVID-19 is a respiratory illness caused by a novel strain of the coronavirus which began infecting United States citizens in the beginning of 2020. The continued spread of COVID-19 and the stay-at-home and social distancing orders of federal, state, and local government authorities continued to impact the University after year end. These impacts include increased costs for sanitation and personal protective equipment for students, faculty, and staff, a decrease in student on-campus housing occupancy, a decline in athletic revenue due to attendance restrictions imposed on sporting events, and significant disruptions to basic and applied research. In addition, the COVID-19 public health emergency has affected the revenues of the foundations that support the University's programs. In response to the onset of the pandemic and subsequent financial uncertainty, the University moved to limit spending and hiring to only that which was essential to our core functions. Additional steps taken included salary reductions and layoffs within the athletics enterprise. The full extent of the financial impact is not estimable by management as it is contingent upon the evolving nature of the COVID-19 pandemic and the responses of governments and citizens and distribution of newly developed vaccines. The University will continue to monitor the revenue losses caused by COVID-19 and pursue additional federal and state assistance available to offset these impacts along with other steps to reduce expenses as deemed necessary.

[Remainder of Page Intentionally Left Blank]

**TOTAL REVENUES OF UNIVERSITY BY SOURCE
FISCAL YEARS 2011 THROUGH 2020**

	Unrestricted						Restricted		
	State Appropriations ¹		Tuition and Fees		Other Revenues		Auxiliary Enterprises	Restricted Funds	% of total
	Amount	% of total	Amount	% of total	Amount	% of total			
Year	Amount	% of total	Amount	% of total	Amount	% of total	Auxiliary Enterprises	Restricted Funds	% of total
2011	222,655,790	25.5%	212,403,023	24.3%	15,540,418	1.8%	177,386,055	246,004,400	48.4%
2012	160,959,450	18.8%	244,768,439	28.6%	18,517,112	2.2%	182,477,128	249,261,692	50.4%
2013	148,015,762	16.8%	275,178,743	31.3%	10,603,373	1.2%	195,329,251	250,967,016	50.7%
2014	131,666,696	14.3%	306,271,172	33.3%	9,459,055	1.1%	197,089,209	274,013,105	51.3%
2015	126,804,512	13.4%	327,994,068	34.7%	12,573,785	1.3%	213,329,102	265,437,933	50.6%
2016	133,865,417	13.2%	370,148,372	36.5%	9,495,650	0.9%	221,883,575	279,838,528	49.4%
2017	131,749,329	13.0%	382,385,085	37.8%	10,197,137	1.0%	220,689,130	265,925,513	48.2%
2018	137,809,558	13.4%	382,761,610	37.2%	13,584,937	1.3%	217,972,108	277,318,176	48.1%
2019	136,213,866	12.6%	405,273,921	37.5%	16,572,584	1.6%	240,303,279	281,400,556	48.3%
2020	140,548,469	12.6%	411,671,920	37.1%	14,188,137	1.3%	243,810,382	300,155,916	49.0%

Source: University

Note: Excludes LSU Agricultural Center. Fiscal Years 2015 and prior excludes LSU Law Center.

Beginning in fiscal year 2016 the LSU campus was realigned to include the LSU Law Center.

¹Reflects actual appropriations received.

[Remainder of Page Intentionally Left Blank]

**UNRESTRICTED REVENUES OF UNIVERSITY BY SOURCE
FISCAL YEARS 2011 THROUGH 2020**

Year	State Appropriations		Tuition and Fees		Other Revenues		Total
	Amount	% of total	Amount	% of total	Amount	% of total	
2011	222,655,790	49.4%	212,403,023	47.1%	15,540,418	3.5%	450,599,231
2012	160,959,450	37.9%	244,768,439	57.7%	18,517,112	4.4%	424,245,001
2013	148,015,762	34.1%	275,178,743	63.4%	10,603,373	2.5%	433,797,878
2014	131,666,696	29.4%	306,271,172	68.5%	9,459,055	2.1%	447,396,923
2015	126,804,512	27.1%	327,994,068	70.2%	12,573,785	2.7%	467,372,365
2016	133,865,417	26.1%	370,148,372	72.1%	9,495,650	1.8%	513,509,439
2017	131,749,329	25.1%	382,385,085	72.9%	10,197,137	2.0%	524,331,551
2018	137,809,558	25.8%	382,761,610	71.7%	13,584,937	2.5%	534,156,105
2019	136,213,866	24.4%	405,273,921	72.6%	16,572,584	3.0%	558,060,371
2020	140,548,469	24.8%	411,671,920	72.7%	14,188,137	2.5%	566,408,526

Source: University

Note: Excludes LSU Agricultural Center. Fiscal Years 2015 and prior excludes LSU Law Center. Beginning in fiscal year 2016 the LSU campus was realigned to include the LSU Law Center.

[Remainder of Page Intentionally Left Blank]

**RESTRICTED REVENUES OF UNIVERSITY BY SOURCE
FISCAL YEARS 2011 THROUGH 2020**

	Grants and Contracts										
	Tuition and Fees		State and Local		Federal		Private		Other		
	Amount	%	Amount	%	Amount	%	Amount	%	Amount	%	
2011	19,198,183	7.8%	35,280,791	14.4%	113,454,350	46.1%	17,763,734	7.2%	60,307,342	24.5%	246,004,400
2012	18,883,635	7.6%	41,038,709	16.5%	110,059,153	44.1%	18,390,610	7.4%	60,889,585	24.4%	249,261,692
2013	18,555,140	7.4%	37,965,480	15.1%	102,654,043	40.9%	19,358,280	7.7%	72,434,073	28.9%	250,967,016
2014	26,370,500	9.6%	38,103,784	13.9%	106,434,717	38.9%	24,441,841	8.9%	78,662,263	28.7%	274,013,105
2015	28,359,187	10.7%	42,630,925	16.0%	94,197,275	35.5%	22,251,598	8.4%	77,998,948	29.4%	265,437,933
2016	33,484,564	12.0%	42,896,241	15.3%	99,760,947	35.6%	18,947,512	6.8%	84,749,264	30.3%	279,838,528
2017	38,203,027	14.4%	39,354,894	14.8%	94,714,555	35.6%	16,599,778	6.2%	77,053,259	29.0%	265,925,513
2018	38,941,839	14.0%	36,520,911	13.2%	99,992,846	36.0%	19,326,415	7.0%	82,536,165	29.8%	277,318,176
2019	41,989,162	14.9%	34,705,957	12.3%	109,185,279	38.8%	21,879,203	7.8%	73,640,955	26.2%	281,400,556
2020	44,427,325	14.8%	34,609,138	11.5%	119,298,807	39.8%	19,617,544	6.5%	82,203,102	27.4%	300,155,916

Source: University

Note: Excludes LSU Agricultural Center. Fiscal Years 2015 and prior excludes LSU Law Center. Beginning in fiscal year 2016 the LSU campus was realigned to include the LSU Law Center.

[Remainder of Page Intentionally Left Blank]

LOUISIANA STATE UNIVERSITY
STATEMENT OF REVENUES, EXPENSES, AND CHANGES IN NET POSITION
FOR THE YEARS ENDED JUNE 30, 2020 AND 2019

	2020	2019
OPERATING REVENUES		
Student tuition and fees	\$ 455,548,633	\$ 446,352,613
Less scholarship allowances	(101,668,659)	(94,389,614)
Net student tuition and fees	353,879,974	351,962,999
Federal appropriations	-	-
Federal grants and contracts	80,304,245	85,181,413
State and local grants and contracts	34,140,615	33,940,570
Nongovernmental grants and contracts	19,439,837	21,599,687
Sales and services of educational departments	22,862,956	22,794,479
Auxiliary enterprise revenues, including revenues pledged as security for bond issues	231,273,553	225,825,137
Less scholarship allowances	(21,994,888)	(21,075,853)
Net auxiliary revenues	209,278,665	204,749,284
Other operating revenues	11,771,250	12,167,926
Total operating revenues	731,677,542	732,396,358
OPERATING EXPENSES		
Educational and general		
Instruction	321,303,144	380,091,054
Research	143,239,587	141,106,266
Public service	32,125,989	30,734,431
Academic support	89,973,699	90,972,487
Student services	29,187,192	31,205,853
Institutional support	44,363,696	37,614,376
Operation and maintenance of plant	117,140,842	124,291,365
Scholarships and fellowships	61,050,069	46,324,163
Auxiliary enterprises	177,984,208	166,560,769
Other operating expenses	-	-
Total operating expenses	1,016,368,426	1,048,900,764
Operating income (loss)	(284,690,884)	(316,504,406)
NONOPERATING REVENUES AND (EXPENSES)		
State appropriations	140,548,469	136,213,866
Gifts	54,741,613	125,909,366
Federal nonoperating revenues (expenses)	43,166,577	28,141,908
Net investment income (loss)	33,609,861	32,055,600
Interest expense	(27,728,634)	(19,174,848)
Other nonoperating revenues (expenses)	703,491	2,355,628
Net nonoperating revenues (expenses)	245,041,377	305,501,520
Income before other revenues, expenses, gains and losses	(39,649,507)	(11,002,886)
Capital appropriations	4,531,550	226,463
Capital gifts and grants	46,622,937	12,276,387
Additions to permanent endowments	1,120,000	480,000
Other additions, net	(1,037,224)	1,835,865
Transfer to/from other LSU campuses	(34,182)	63,265
Increase (decrease) in net assets	11,553,574	3,879,094
Net assets at beginning of year, restated	(117,005,193)	(130,284,516)
Net assets at end of year	\$ (105,451,619)	\$ (126,405,422)

Source: University

NON-CASH EXPENSES

The following table reflects the calculated Non-Cash Net Pension and Other Post-Employment Benefit (OPEB) expenses which are included in the Operating Expenses section on the Statement of Revenues, Expenses, and Changes in Net Position for Louisiana State University.

**NON-CASH PENSION AND OPEB EXPENSES
FOR THE YEARS ENDED JUNE 30, 2020 AND 2019**

	2020	2019
NET PENSION	(5,640,829)	(29,807,842)
OPEB	27,834,815	14,922,681

Source: University

[Remainder of Page Intentionally Left Blank]

THE AUXILIARY ENTERPRISES

There exist at the University Auxiliary Enterprises under the control, operation or supervision of the Board, which generate revenues and are operated essentially as self-supporting enterprises designed to generate revenues sufficient to maintain their operation. In certain years some Auxiliary Enterprises have produced negative cash flows; however, it is the policy of the Board that each Auxiliary Enterprise is operated essentially as a self-supporting entity. Fees, rates, rentals, charges or other receipts or income constituting a major part of the Auxiliary Revenues generated by these Auxiliary Enterprises and used to pay Base Rental pursuant to the Facilities Lease are not subject to appropriation by the Legislature and are held in Board accounts outside the State Treasury. The funds and accounts of these Auxiliary Enterprises are, however, audited by the State Legislative Auditor. The Board has the power to restrict the self-generated revenues of Auxiliary Enterprises.

Auxiliary Facilities consist of the buildings, land, equipment and other properties under the control, operation or supervision of the following Auxiliary Enterprises of the University as the same may be modified from time to time: (1) University Stores, (2) Student Media, (3) the LSU Union, (4) Golf Course, (5) Graphic Services, (6) Laboratory School Cafeteria, (7) Parking, Traffic and Transportation, (8) Athletics, (9) Student Health Services, (10) University Auxiliary Services, (11) Residential Life, provided that in the event Auxiliary Revenue producing activities or any portion of any such Auxiliary Enterprise are transferred to another University Enterprise, the portion of such University Enterprise used for such activity shall be deemed to be an Auxiliary Facility under the General Bond Resolution and Auxiliary Facilities as defined thereby may be modified as set forth therein.

Auxiliary Revenues consist of (i) (a) the gross amount of all funds, monies or revenues held by the University and any earnings thereon derived or to be derived by Auxiliary Enterprises from self-generated revenues from all fees, rates, rentals, charges or other receipts or income received from students or the public at large in connection with any undertaking, utilization or operation of Auxiliary Enterprises or Auxiliary Facilities, including operation or management thereof by private entities on behalf of the Auxiliary Enterprises, prior to the payment of Current Expenses, (b) Lab School Revenues (as defined in the General Bond Resolution), provided that Lab School Revenues shall be deemed to constitute Auxiliary Revenues only until the later of (A) July 1, 2034 (the final maturity date of the Series 2012 Bonds) and (B) the maturity date of any Auxiliary Revenue Bonds issued to finance or refinance projects for the Lab School, and (c) Recreational Sports Fee Revenues (as defined in the General Bond Resolution), provided, however, that Recreational Sports Fee Revenues shall be deemed to constitute Auxiliary Revenues only until the later of (A) July 1, 2043 (the final maturity date of the Series 2013 Bonds) and (B) the maturity date of any Auxiliary Revenue Bonds issued to finance or refinance projects for the Student Recreational Sports Complex; and (ii) all Funds and Accounts held pursuant to the General Bond Resolution pertaining to a particular Series of Auxiliary Revenues Bonds except any fund created to hold monies pending rebate to the United States or for payment of costs of issuance of Auxiliary Revenue Bonds. Auxiliary Revenues shall not include funds appropriated to LSU by the Legislature of the State from time to time.

"Lab School Revenues" means the revenues derived by the Lab School from a \$500 tuition increase effective with the 2000-01 school year and a \$265 tuition increase effective with the 2001-02 school year in accordance with House Bill No. 1920 of the 1999 Regular Session of the Louisiana Legislature and with a resolution adopted by the Board on July 16, 1999.

"Recreational Sports Fee Revenues" means (a) the \$15.00 per fall and spring semesters increase and \$5.00 per summer semester increase in the self-assessed student recreational sports fee authorized by the Board by its resolution adopted May 31, 2002 and (b) (i) the \$20.00 per summer semester increase beginning summer semester of the 2012-13 academic year, (ii) the \$45.00 per fall and spring semesters increase and \$20.00 per summer semester increase beginning fall semester of the 2013-14 academic year, (iii) the \$45.00 per fall and spring semesters increase and \$20.00 per summer semester increase to be imposed beginning fall semester of the 2014-15 academic year and (iv) the \$45.00 per fall and spring semesters increase to be

imposed beginning fall semester of the 2015-16 academic year in the student recreational sports fee authorized by the Board by its resolution adopted February 1, 2013, such that the total summer fee in 2015 and thereafter will be \$85 and the total fall and spring semester fee in 2015-2016 and thereafter will be \$200.

Auxiliary Revenues do not include funds appropriated to the Board by the Legislature of the State from time to time.

The obligation of the Board to pay Debt Service Requirements on the Series 2022 Bonds and on the Outstanding Parity Bonds from Auxiliary Revenues shall be superior to any other claim on such funds.

Tables 1 through 8 present an analysis of revenues and expenditures of each of the Auxiliary Enterprises.

TABLE 1
UNIVERSITY STORES
ANALYSIS OF REVENUES AND EXPENDITURES
FOR THE FISCAL YEARS ENDED JUNE 30
(DOLLARS)

	2020	2019	2018	2017	2016
REVENUES					
Sales and services	\$ 4,426,616	\$ 5,466,946	\$ 5,434,420	\$ 5,026,812	\$ 6,579,597
Interest on investments	7,308	7,933	9,092	13,803	15,519
Gross Revenues	4,433,924	5,474,879	5,443,512	5,040,615	6,595,116
EXPENSES					
Cost of goods sold	3,741,921	4,756,314	4,798,097	4,067,512	6,035,650
Salaries and wages	335,097	360,069	377,730	386,940	451,658
Related benefits	152,866	162,940	151,562	154,149	172,373
Administrative charge	48,503	42,597	64,225	34,128	51,782
Supplies and expenses	175,431	249,696	120,188	393,155	136,912
Travel	1,970	-	2,295	1,861	
Depreciation	1,783	1,783	-	2,511	-
Total Expenses	4,457,571	5,573,399	5,514,097	5,040,256	6,848,375
REVENUES OVER EXPENSES	\$ (23,647)	\$ (98,520)	\$ (70,585)	\$ 359	\$ (253,259)

Source: University

Note: Prior to 2017, Travel was included in Supplies and expenses.

[Remainder of Page Intentionally Left Blank]

TABLE 2

**STUDENT MEDIA
ANALYSIS OF REVENUES AND EXPENDITURES
FOR THE FISCAL YEARS ENDED JUNE 30
(DOLLARS)**

	2020	2019	2018	2017	2016
REVENUES					
Sales and services	\$ 280,086	\$ 311,061	\$ 234,992	\$ 283,146	\$ 361,720
Fee allocations	876,630	896,255	910,219	948,944	977,035
Interest on investments	26,557	23,080	18,675	13,868	15,591
Gross Revenues	1,183,273	1,230,396	1,163,886	1,245,958	1,354,346
EXPENSES					
Salaries & Wages	583,847	609,632	597,679	694,561	832,448
Related benefits	166,084	149,040	112,861	153,390	169,001
Administrative charge	73,824	69,833	74,757	74,489	83,668
Supplies and expenses	186,444	218,612	192,884	197,207	307,830
Travel	16,426	8,812	5,301	4,800	
Depreciation	27,011	27,533	37,882	45,067	49,919
Total Expenses	1,053,636	1,083,462	1,021,364	1,169,514	1,442,866
REVENUES OVER EXPENSES	\$ 129,637	\$ 146,934	\$ 142,522	\$ 76,444	\$ (88,520)

Source: University

Note: Prior to 2017, Travel was included in Supplies and expenses.

[Remainder of Page Intentionally Left Blank]

TABLE 3

**LSU UNION
ANALYSIS OF REVENUES AND EXPENDITURES
FOR THE FISCAL YEARS ENDED JUNE 30
(DOLLARS)**

	2020	2019	2018	2017	2016
REVENUES					
Administration and building services	\$ 673,464	\$ 712,118	\$ 731,405	\$ 662,845	\$ 648,402
Barber shop	-	-	-	2,528	38,429
Event management	-	-	-	-	177,589
Food services	511,325	595,474	610,176	676,099	675,653
Performing arts	2,634	-	-	3,786	-
Promotions	124,355	186,854	187,949	188,462	-
Theater	141,889	296,584	285,348	264,534	273,979
Fee allocations	7,417,218	7,572,377	7,737,199	8,075,330	8,315,492
Interest on Investments	295,218	279,448	241,413	220,966	220,377
Gross Revenues	9,166,103	9,642,855	9,793,490	10,094,550	10,349,921
EXPENSES					
Salaries & Wages	1,256,777	1,382,143	1,315,384	1,307,366	1,352,855
Related benefits	526,388	541,031	506,445	469,733	507,752
Supplies and expenses	1,618,844	1,533,831	1,870,636	1,827,589	2,051,905
Utilities and debt service	4,867,550	4,904,879	4,873,183	4,683,613	5,042,363
Depreciation	18,904	24,622	33,706	33,446	38,292
Total Expenses	8,288,463	8,386,506	8,599,354	8,321,747	8,993,167
REVENUES OVER EXPENSES	\$ 877,640	\$ 1,256,349	\$ 1,194,136	\$ 1,772,803	\$ 1,356,754

Source: University

[Remainder of Page Intentionally Left Blank]

TABLE 4

**PARKING AND TRANSPORTATION SERVICES
ANALYSIS OF REVENUES AND EXPENDITURES
FOR THE FISCAL YEARS ENDED JUNE 30
(DOLLARS)**

	2020	2019	2018	2017	2016
REVENUES					
Sales and services	\$ 7,208,371	\$ 8,274,486	\$ 8,528,472	\$ 8,633,695	\$ 8,777,833
Fee allocations	3,846,592	3,847,453	3,815,494	3,984,650	4,103,649
Interest on investments	157,959	206,154	206,085	184,328	174,709
Gross Revenues	11,212,922	12,328,093	12,550,051	12,802,673	13,056,191
EXPENSES					
Salaries & Wages	1,855,527	1,789,483	1,658,874	1,694,878	1,964,424
Related benefits	722,918	699,483	622,573	583,146	616,051
Administrative charge	832,147	828,303	844,976	796,428	837,182
Supplies and expenses	6,023,704	6,404,715	6,159,748	6,191,531	6,076,537
Travel	19,476	12,577	4,625	5,065	
Principal and interest	2,116,376	2,464,100	2,467,340	2,353,992	2,363,085
Utilities	157,743	164,098	171,171	133,988	-
Depreciation	48,506	56,186	70,748	110,344	113,975
Total Expenses	11,776,397	12,418,945	12,000,055	11,869,372	11,971,254
REVENUES OVER EXPENSES	\$ (563,475)	\$ (90,852)	\$ 549,996	\$ 933,301	\$ 1,084,937

Source: University

Note: Prior to 2017, Travel was included in Supplies and expenses.

[Remainder of Page Intentionally Left Blank]

TABLE 5

**ATHLETICS
ANALYSIS OF REVENUES AND EXPENDITURES
FOR THE FISCAL YEARS ENDED JUNE 30
(DOLLARS)**

	2020	2019	2018	2017	2016
REVENUES					
Men's sports	\$ 46,040,630	\$ 49,616,029	\$ 47,226,474	\$ 46,620,543	\$ 48,212,235
Women's sports	467,682	575,729	573,531	564,537	500,365
Athletic related activities	29,260,785	27,513,710	27,131,721	27,445,237	24,705,022
Southeastern Conference distribution	29,922,721	28,837,768	27,176,584	26,196,959	25,141,784
Hosted events and postseason activity	4,255,835	2,988,076	2,140,960	2,582,215	1,744,984
Miscellaneous	29,894,644	29,527,826	27,627,909	30,142,740	29,557,633
Interest on investments	853,228	830,885	1,019,788	907,140	993,336
Gross Revenues	140,695,525	139,890,023	132,896,967	134,459,371	130,855,359
EXPENSES					
Salaries & Wages	39,775,623	35,527,641	32,050,112	30,006,388	26,983,404
Related benefits	12,984,689	11,577,728	10,466,392	9,737,760	8,590,562
Supplies and expenses	55,361,567	58,027,918	57,676,099	56,590,364	57,892,107
Utilities and debt service	8,115,846	7,919,100	7,890,438	7,439,620	6,559,900
Athletic related activities	1,106,227	1,740,575	1,896,757	1,407,045	735,986
Scholarships	16,105,434	16,440,856	15,188,999	15,072,974	14,699,715
Hosted events and postseason activity	6,773,718	5,038,471	4,481,731	3,757,609	3,079,298
Depreciation	629,965	642,602	570,073	571,464	503,546
Total Expenses	140,853,069	136,914,891	130,220,601	124,583,224	119,044,518
REVENUES OVER EXPENSES	\$ (157,544)	\$ 2,975,132	\$ 2,676,366	\$ 9,876,147	\$ 11,810,841

Source: University

[Remainder of Page Intentionally Left Blank]

TABLE 6

**UNIVERSITY AUXILIARY SERVICES
ANALYSIS OF REVENUES AND EXPENDITURES
FOR THE FISCAL YEARS ENDED JUNE 30
(DOLLARS)**

	2020	2019	2018	2017	2016
REVENUES					
Sales and services	\$ 2,064,552	\$ 2,541,380	\$ 2,542,587	\$ 2,426,932	\$ 2,619,404
Commissions, leases, student meal plans	2,685,591	2,939,122	2,917,135	2,778,821	2,903,016
Interest on investments	307,924	290,306	230,001	137,224	154,281
Gross Revenues	5,058,067	5,770,808	5,689,723	5,342,977	5,676,701
EXPENSES					
Salaries & Wages	645,618	721,319	795,429	799,624	826,630
Related benefits	284,250	318,326	326,428	336,518	319,443
Administrative charge	335,232	314,763	294,353	292,812	318,701
Supplies and expenses	2,071,075	2,203,794	2,321,616	2,333,730	2,261,479
Travel	7,042	12,920	7,877	10,513	
Utilities	67,073	77,757	16,171	(1,593)	(13,502)
Depreciation	8,739	34,896	17,837	21,014	19,961
Total Expenses	3,419,029	3,683,775	3,779,711	3,792,618	3,732,712
REVENUES OVER EXPENSES	\$ 1,639,038	\$ 2,087,033	\$ 1,910,012	\$ 1,550,359	\$ 1,943,989

Source: University

Note: Prior to 2017, Travel was included in Supplies and expenses.

[Remainder of Page Intentionally Left Blank]

TABLE 7

**RESIDENTIAL LIFE
ANALYSIS OF REVENUES AND EXPENDITURES
FOR THE FISCAL YEARS ENDED JUNE 30
(DOLLARS)**

	2020	2019	2018	2017	2016
REVENUES					
Residence halls	\$ 34,767,868	\$ 35,379,993	\$ 35,473,606	\$ 37,222,768	\$ 37,679,233
Apartments	935,989	834,040	1,089,780	865,457	1,788,831
Greek housing	631,778	658,267	654,717	612,429	282,312
LSU cable TV	1,881,905	1,607,625	1,152,153	1,158,505	1,233,693
Public Private Partnership	20,953,453	14,569,046			
Miscellaneous	735,611	738,779	565,366	508,306	749,302
Interest on investments	465,918	543,330	465,408	546,052	476,301
Gross Revenues	60,372,522	54,331,080	39,401,030	40,913,517	42,209,672
EXPENSES					
Salaries and wages	10,166,375	10,180,252	8,819,580	9,001,617	9,451,879
Related benefits	3,610,292	3,430,227	3,123,163	3,033,037	3,128,669
Supplies and expenses	28,645,367	17,619,633	8,999,287	7,959,794	8,585,842
Utilities	3,052,376	3,269,448	2,712,947	2,688,107	2,589,130
Principal and interest	12,698,759	12,737,637	12,024,001	12,185,843	13,659,094
Alterations and maintenance	3,738,598	4,771,699	1,909,421	1,943,323	2,090,097
Depreciation	48,026	44,844	33,959	40,535	41,046
Total Expenses	61,959,793	52,053,740	37,622,358	36,852,256	39,545,757
REVENUES OVER EXPENSES	\$ (1,587,271)	\$ 2,277,340	\$ 1,778,672	\$ 4,061,261	\$ 2,663,915

Source: University

Note: Public Private Partnership began in FY2019

[Remainder of Page Intentionally Left Blank]

TABLE 8

**MISCELLANEOUS AUXILIARY ENTERPRISES¹
ANALYSIS OF REVENUES AND EXPENDITURES
FOR THE FISCAL YEARS ENDED JUNE 30
(DOLLARS)**

	2020	2019	2018	2017	2016
REVENUES					
Sales and services	\$ 1,477,073	\$ 1,990,712	\$ 2,021,134	\$ 1,916,978	\$ 2,635,857
Fee allocations	10,014,763	9,433,875	8,815,257	8,682,636	8,936,959
Interest on investments	196,210	210,558	197,058	189,854	213,453
Gross Revenues	11,688,046	11,635,145	11,033,449	10,789,468	11,786,269
EXPENSES					
Cost of goods sold	437,636	446,749	356,743	336,515	627,169
Salaries & wages	5,957,527	6,193,320	5,927,128	5,723,600	6,170,013
Related benefits	2,518,005	2,555,908	2,421,700	2,298,369	2,434,502
Administrative charge	779,286	746,106	735,231	720,336	826,220
Supplies and expenses	1,372,123	1,529,206	1,452,921	1,419,333	1,698,806
Travel	19,244	52,698	55,547	32,874	
Utilities	65,596	90,843	78,880	91,408	88,823
Depreciation	91,319	93,932	127,601	124,296	118,544
Total Expenses	11,240,736	11,708,762	11,155,751	10,746,731	11,964,077
REVENUES OVER EXPENSES	\$ 447,310	\$ (73,617)	\$ (122,302)	\$ 42,737	\$ (177,808)

Source: University

¹Includes Golf Course, Lab School Cafeteria and Student Health Center

Note: Prior to 2017, Travel was included in Supplies and expenses.

[Remainder of Page Intentionally Left Blank]

HISTORICAL AUXILIARY REVENUES

The following table shows the total Auxiliary Revenues and the relative contribution¹ of each Auxiliary Enterprise or other fee revenue that constitutes Auxiliary Revenues for fiscal years 2016 through 2020.

	2016		2017		2018		2019		2020	
	Amount	% Total	Amount	% Total	Amount	% Total	Amount	% Total	Amount	% Total
Athletics	130,855,359	56.0	134,459,371	58.0	132,896,967	58.1	139,890,023	55.8	140,695,525	55.3
LSU Union	10,349,921	4.4	10,094,550	4.4	9,793,490	4.3	9,642,855	3.8	9,166,103	3.6
Residential Life	42,209,672	18.1	40,913,517	17.7	39,401,030	17.2	54,331,080	21.7	60,372,522	23.7
University Stores	6,595,116	2.8	5,040,615	2.2	5,443,512	2.4	5,474,879	2.2	4,433,924	1.7
Parking and Transportation Services	13,056,191	5.6	12,802,673	5.5	12,550,051	5.5	12,328,093	4.9	11,212,922	4.4
Student Media	1,354,346	0.6	1,245,958	0.5	1,163,886	0.5	1,230,396	0.5	1,183,273	0.5
University Auxiliary Services	5,676,701	2.4	5,342,977	2.3	5,689,723	2.5	5,770,808	2.3	5,058,067	2.0
Laboratory School Cafeteria	432,121	0.2	422,411	0.2	453,534	0.2	469,244	0.2	354,298	0.1
Student Health Center	10,397,723	4.5	9,475,752	4.1	9,699,824	4.2	10,353,677	4.1	10,854,460	4.3
Golf Course	956,425	0.4	891,305	0.4	880,091	0.4	812,224	0.3	479,288	0.2
Recreational Sports Fee Revenues ²	8,708,382	3.7	8,468,493	3.7	8,121,505	3.6	8,204,640	3.3	8,269,637	3.3
Lab School Revenues ²	1,084,616	0.5	1,106,871	0.5	1,099,472	0.5	1,091,935	0.4	1,087,531	0.4
LSU Press ³	1,776,044	0.8	1,210,539	0.5	1,394,405	0.6	1,261,821	0.5	1,237,574	0.5
Total	233,452,617	100%	231,475,032	100%	228,587,490	100%	250,861,675	100%	254,405,124	100%

Source: University

¹ Percentages rounded to nearest tenth.

² Not an Auxiliary Enterprise, but (a) Lab School Revenues are deemed to constitute Auxiliary Revenues under the General bond Resolution and any Supplemental Resolutions until the later of (i) July 1, 2034 and (ii) the maturity date of any bonds issued to finance or refinance projects for the Lab School, and (b) the Recreational Sports Fee Revenues are deemed to constitute Auxiliary Revenues under the General Bond Resolution and any Supplemental Resolutions until the later of (i) July 1, 2043 and (ii) maturity date of any bonds issued to finance or refinance projects for the Student Recreational Sports Complex.

³ Effective July 1, 2010, the LSU Press was restructured and the internal classification as an Auxiliary Enterprise was removed. Therefore, the LSU Press is no longer presented in the financial statements of the University as an Auxiliary Enterprise. However, for purposes of the Bonds issued pursuant to the General Bond Resolution and any Supplemental Resolutions, including, without limitation, the LSU Press is deemed to be an Auxiliary Enterprise, and the revenues of the LSU Press are deemed to be Auxiliary Revenues and are pledged as security for such Bonds.

Auxiliary Revenues are used by the Board to fund the operations of the Auxiliary Enterprises and, therefore, all such amounts are not set aside for payment of debt service on the Auxiliary Revenue Bonds and the Base Rental Requirements of the Facilities Lease.

The Auxiliary Enterprises operate essentially as self-supporting enterprises with budgets for all operating expenses to be paid from self-generated revenues. Over the years, one or more of the Auxiliary Enterprises have, from time to time, failed to generate annual revenues sufficient to pay all expenses of operation. However, such deficiencies have been covered by fund balances on hand from previous operating surpluses and, on a combined basis, Auxiliary Revenues have historically exceeded expenses of Auxiliary Enterprises as shown below:

	2016	2017	2018	2019	2020
Total Auxiliary Revenues ¹	\$ 233,452,617	\$ 231,475,032	\$ 228,587,490	\$ 250,861,675	\$ 254,405,124
Total Auxiliary Expenditures ²	211,036,327	209,909,974	214,244,259	238,715,809	250,024,386
Excess Auxiliary Revenues over Auxiliary Expenditures	\$ 22,416,290	\$ 21,565,058	\$ 14,343,231	\$ 12,145,866	\$ 4,380,738

Source: University

- ¹ Includes Lab School Revenues until the later of (i) July 1, 2034 and (ii) the maturity date of any Auxiliary Revenue Bonds issued to finance or refinance projects for the Lab School, and Recreational Sports Fee Revenues until the later of (i) July 1, 2043 and (ii) the maturity date of any Auxiliary Revenue Bonds issued to finance or refinance projects for the Student Recreational Sports Complex.
- ² Includes debt service on outstanding Auxiliary Revenue Bonds.

**OUTSTANDING AUXILIARY REVENUE BONDS
AS OF JUNE 30, 2020**

Auxiliary Revenue Bonds, Series 2012	31,335,000
Auxiliary Revenue Bonds, Series 2013	48,840,000
Auxiliary Revenue Refunding Bonds, Series 2014	70,775,000
Auxiliary Revenue Refunding Bonds, Series 2016A	115,400,000
Taxable Auxiliary Revenue Refunding Bonds, Series 2016B	10,980,000
Auxiliary Revenue Refunding Bonds, Series 2016A	71,370,000
Total	\$ 348,700,000

[Remainder of Page Intentionally Left Blank]

The following table sets forth the Annual Debt Service Requirements for the outstanding Auxiliary Revenue Bonds and Base Rental Requirement for the Fiscal Years ending June 30, 2021 to June 30, 2059, inclusive.

ANNUAL DEBT SERVICE REQUIREMENTS ON OUTSTANDING AUXILIARY REVENUE BONDS AND BASE RENTAL REQUIREMENT AS OF JUNE 30, 2020

FISCAL YEAR	TOTAL AUXILIARY REVENUE BONDS	BASE RENTAL REQUIREMENT	TOTAL DEBT SERVICE
2021	29,757,516	15,417,050	45,174,566
2022	29,720,962	18,659,998	48,380,960
2023	29,669,061	19,308,588	48,977,649
2024	29,606,975	19,308,588	48,915,563
2025	29,198,002	19,308,588	48,506,590
2026	29,135,698	19,308,588	48,444,286
2027	27,270,847	19,308,588	46,579,435
2028	27,255,502	19,308,588	46,564,090
2029	27,259,329	19,308,588	46,567,917
2030	27,247,145	19,308,588	46,555,733
2031	25,521,429	19,308,588	44,830,017
2032	25,529,565	19,308,588	44,838,153
2033	23,933,423	19,308,588	43,242,011
2034	23,665,818	19,308,588	42,974,406
2035	20,877,654	19,308,588	40,186,242
2036	20,872,453	19,308,588	40,181,041
2037	13,482,720	19,427,425	32,910,145
2038	11,921,718	21,221,212	33,142,930
2039	11,917,502	21,233,975	33,151,477
2040	11,920,346	21,231,625	33,151,971
2041	6,389,200	27,114,625	33,503,825
2042	6,387,000	27,118,100	33,505,100
2043	6,390,800	27,114,563	33,505,363
2044		33,505,675	33,505,675
2045		33,502,500	33,502,500
2046		33,504,875	33,504,875
2047		33,501,275	33,501,275
2048		33,503,650	33,503,650
2049		33,505,025	33,505,025
2050		33,502,925	33,502,925
2051		33,505,050	33,505,050
2052		33,504,800	33,504,800
2053		33,501,325	33,501,325
2054		33,504,575	33,504,575
2055		33,503,050	33,503,050
2056		33,504,325	33,504,325
2057		33,502,250	33,502,250
2058		33,502,375	33,502,375
2059		33,506,000	33,506,000
TOTAL	\$ 494,930,665	\$ 1,004,918,480	\$ 1,499,849,145

**PRO FORMA DEBT SERVICE AND
BASE RENTAL COVERAGE RATIOS**

The following table shows the availability of [2020-21] Auxiliary Revenues to satisfy (i) Debt Service Requirements on the Outstanding Parity Bonds (including the Refunded Bonds) and (ii) Base Rental on the Subordinate Lease Obligations on a pro forma basis. The [2020-21] net Auxiliary Revenues do not include income from the Greenhouse District (Phase II) Student Housing Facilities and Greenhouse District (Phase III) Student Housing Facilities, which are scheduled to come on line in the future.

Fiscal Year	[2020-2021]
Gross Auxiliary Revenues ¹	
Total Auxiliary Expenditures ²	
Net Auxiliary Revenues	
Maximum Annual Debt Service Requirements on Outstanding Parity Bonds	
Pro-Forma Gross Debt Service Coverage on Outstanding Parity Bonds ³	
Pro-Forma Net Debt Service Coverage on Outstanding Parity Bonds ⁴	
Maximum Annual Debt Service Requirements on Outstanding Auxiliary Revenue Bonds and Base Rental ⁷	
Pro-Forma Gross Debt Service Coverage Ratio on Outstanding Auxiliary Revenue Bonds and Base Rental ⁵	
Pro-Forma Net Debt Service Coverage Ratio on Outstanding Auxiliary Revenue Bonds and Base Rental ⁶	

¹ Includes Lab School Revenues and Recreational Sports Fee Revenues as provided in the Bond Resolution.

² Excludes Debt Service on outstanding Auxiliary Revenue Bonds.

³ Calculated by dividing Gross Auxiliary Revenues by Maximum Annual Debt Service.

⁴ Calculated by dividing Net Auxiliary Revenues by Maximum Annual Debt Service.

⁵ Calculated by dividing Gross Auxiliary Revenues by Maximum Annual Debt Service and Maximum Base Rental Requirement.

⁶ Calculated by dividing Net Auxiliary Revenues by Maximum Annual Debt Service and Maximum Base Rental Requirement.

⁷ Base rental includes the Nicholson Gateway Facilities Lease, the Greenhouse District (Phase II) Facilities Lease and the Greenhouse District (Phase III) Facilities Lease.

[Remainder of Page Intentionally Left Blank]

APPENDIX B

**FINANCIAL REPORT OF THE LSU
SYSTEM FOR THE YEAR ENDED JUNE 30, 2020**

APPENDIX C

PROPOSED FORM OF OPINION OF BOND COUNSEL

APPENDIX D

DEFINITIONS OF CERTAIN TERMS

APPENDIX E

SUMMARY OF CERTAIN PROVISIONS
OF THE BOND RESOLUTION

APPENDIX F

FORM OF CONTINUING DISCLOSURE CERTIFICATE

APPENDIX G-1

SERIES 2012 REFUNDED BONDS

(to come)

APPENDIX G-2

SERIES 2013 REFUNDED BONDS

(to come)

APPENDIX G-3

SERIES 2014 REFUNDED BONDS

(to come)

APPENDIX G-4

SERIES 2016A REFUNDED BONDS

(to come)

APPENDIX H **BOOK-ENTRY ONLY SYSTEM**

The information in this section concerning The Depository Trust Company ("DTC") New York, New York and DTC's book-entry-only system has been obtained from DTC. None of the Board, the Trustee or the Underwriter make any representations, warranties or guarantees with respect to its accuracy or completeness.

The Series 2022 Bonds initially will be issued solely in book-entry form to be held in the book-entry only system maintained by The Depository Trust Company ("DTC"), New York, New York. So long as such book-entry only system is used, only DTC will receive or have the right to receive physical delivery of the Series 2022 Bonds and, except as otherwise provided herein with respect to Beneficial Owners of Beneficial Ownership Interests, Beneficial Owners will not be or be considered to be, and will not have any rights as owners or holders of the Series 2022 Bonds under the Bond Ordinance.

The following information about the book-entry only system applicable to the Series 2022 Bonds has been supplied by DTC. The Board, the Trustee and the Underwriter make no representations, warranties or guarantees with respect to its accuracy or completeness.

DTC will initially act as securities depository for the Series 2022 Bonds. The Series 2022 Bonds will be issued as fully registered Series 2022 Bonds registered in the name of Cede & Co. (DTC's partnership nominee) or such other name as may be requested by an authorized representative of DTC. One fully registered Bond will be issued for each maturity of the Series 2022 Bonds in the aggregate principal amount of such maturity, and will be deposited with DTC.

DTC, the world's largest securities depository, is a limited-purpose trust company organized under the New York Banking Law, a "banking organization" within the meaning of the New York Banking Law, a member of the Federal Reserve System, a "clearing corporation" within the meaning of the New York Uniform Commercial Code, and a "clearing agency" registered pursuant to the provisions of Section 17A of the Securities Exchange Act of 1934. DTC holds and provides asset servicing for over 3.5 million issues of U.S. and non-U.S. equity issues, corporate and municipal debt issues, and money market instruments (from over 100 countries) that DTC's participants ("Direct Participants") deposit with DTC. DTC also facilitates the post-trade settlement among Direct Participants of sales and other securities transactions in deposited securities, through electronic computerized book-entry transfers and pledges between Direct Participants' accounts. This eliminates the need for physical movement of securities certificates. Direct Participants include both U.S. and non-U.S. securities brokers and dealers, banks, trust companies, clearing corporations, and certain other organizations. DTC is a wholly-owned subsidiary of The Depository Trust & Clearing Corporation ("DTCC"). DTCC is the holding company for DTC, National Securities Clearing Corporation and Fixed Income Clearing Corporation, all of which are registered clearing agencies. DTCC is owned by the users of its regulated subsidiaries. Access to the DTC system is also available to others such as both U.S. and non-U.S. securities brokers and dealers, banks, trust companies and clearing corporations that clear through or maintain a custodial relationship with a Direct Participant, either directly or indirectly ("Indirect Participants"). DTC has an S&P Global Rating of AA+. The DTC Rules applicable to its Participants are on file with the U.S. Securities and Exchange Commission (the "SEC"). More information about DTC can be found at www.dtcc.com.

Purchases of the Series 2022 Bonds under the DTC system must be made by or through Direct Participants, which will receive a credit for the Series 2022 Bonds on DTC's records. The ownership interest of each actual purchaser of each Bond ("Beneficial Owner") is in turn to be recorded on the Direct and Indirect Participants' records. Beneficial Owners will not receive written confirmation from DTC of their purchase. Beneficial Owners are, however, expected to receive written confirmations providing details of the transaction, as well as periodic statements of their holdings, from the Direct or Indirect Participant through which the Beneficial Owner entered into the transaction. Transfers of ownership interests in the Series 2019 Bonds are to be accomplished by entries made on the books of Direct and Indirect Participants acting on behalf of Beneficial Owners. Beneficial Owners will not receive certificates representing their ownership interests in Series 2022 Bonds, except in the event that use of the book-entry system for the Series 2022 Bonds is discontinued.

To facilitate subsequent transfers, all Series 2022 Bonds deposited by Direct Participants with DTC are registered in the name of DTC's partnership nominee, Cede & Co., or such other name as may be requested by an authorized representative of DTC. The deposit of Series 2022 Bonds with DTC and their registration in the name of Cede & Co. or such other DTC nominee do not effect any change in beneficial ownership. DTC has no knowledge of the actual Beneficial Owners of the Series 2022 Bonds; DTC's records reflect only the identity of the Direct Participants to whose accounts such Series 2022 Bonds are credited, which may or may not be the Beneficial Owners. The Direct and Indirect Participants will remain responsible for keeping account of their holdings on behalf of their customers.

Conveyance of notices and other communications by DTC to Direct Participants, by Direct Participants to Indirect Participants, and by Direct Participants and Indirect Participants to Beneficial Owners will be governed by arrangements among them, subject to any statutory or regulatory requirements as may be in effect from time to time. Beneficial Owners of Series 2022 Bonds may wish to take certain steps to augment the transmission to them of notices of significant events with respect to the Series 2022 Bonds, such as redemptions, tenders, defaults, and proposed amendments to the Bond documents. For example, Beneficial Owners of Series 2022 Bonds may wish to ascertain that the nominee holding the Series 2022 Bonds for their benefit has agreed to obtain and transmit notices to Beneficial Owners. In the alternative, Beneficial Owners may wish to provide their names and addresses to the registrar and request that copies of notices be provided directly to them.

Redemption notices shall be sent to DTC. If less than all of the Series 2022 Bonds within an issue are being redeemed, DTC's practice is to determine by lot the amount of the interest of each Direct Participant in such issue to be redeemed.

Neither DTC nor Cede & Co. (nor any other DTC nominee) will consent or vote with respect to the Series 2022 Bonds unless authorized by a Direct Participant in accordance with DTC's MMI Procedures. Under its usual procedures, DTC mails an Omnibus Proxy to the Board as soon as possible after the record date. The Omnibus Proxy assigns Cede & Co.'s consenting or voting rights to those Direct Participants to whose accounts Series 2022 Bonds are credited on the record date (identified in a listing attached to the Omnibus Proxy).

Principal and interest payments on the Series 2022 Bonds will be made to Cede & Co., or such other nominee as may be requested by an authorized representative of DTC. DTC's practice is to credit Direct Participants' accounts upon DTC's receipt of funds and corresponding detail information from the Board or Trustee on payable date in accordance with their respective holdings shown on DTC's records. Payments by Participants to Beneficial Owners will be governed by standing instructions and customary practices, as is the case with securities held for the accounts of customers in bearer form or registered in "street name," and will be the responsibility of such Participant and not of DTC, the Trustee or the Board, subject to any statutory or regulatory requirements as may be in effect from time to time. Payment of principal and interest to Cede & Co. (or such other nominee as may be requested by an authorized representative of DTC) is the responsibility of the Board or Trustee, disbursement of such payments to Direct Participants will be the responsibility of DTC, and disbursement of such payments to the Beneficial Owners will be the responsibility of Direct and Indirect Participants.

DTC may discontinue providing its services as depository with respect to the Series 2022 Bonds at any time by giving reasonable notice to the Board or Trustee. Under such circumstances, in the event that a successor depository is not obtained, the Series 2022 Bonds are required to be printed and delivered.

The Board may decide to discontinue use of the system of book-entry only transfers through DTC (or a successor securities depository). In that event, Series 2022 Bonds will be printed and delivered to DTC.

The information in this section concerning DTC and DTC's book-entry system has been obtained from sources that the Board believes to be reliable, but the Board takes no responsibility for the accuracy thereof.

THE BOARD, THE UNIVERSITY, THE TRUSTEE AND THE UNDERWRITER CANNOT AND DO NOT GIVE ANY ASSURANCES THAT THE DIRECT PARTICIPANTS OR THE INDIRECT PARTICIPANTS WILL DISTRIBUTE TO THE BENEFICIAL OWNERS OF THE BONDS (i) PAYMENTS OF PRINCIPAL OF OR INTEREST ON THE BONDS, (ii) CERTIFICATES REPRESENTING AN OWNERSHIP INTEREST OR OTHER CONFIRMATION OF BENEFICIAL OWNERSHIP INTERESTS IN THE BONDS, OR (iii) REDEMPTION OR OTHER NOTICES SENT TO DTC OR CEDE & CO., ITS NOMINEE, AS THE REGISTERED OWNERS OF THE BONDS, OR THAT THEY WILL DO SO ON A TIMELY BASIS OR THAT DTC OR DIRECT OR INDIRECT PARTICIPANTS WILL SERVE AND ACT IN THE MANNER DESCRIBED IN THIS OFFICIAL STATEMENT. THE CURRENT "RULES" APPLICABLE TO DTC ARE ON FILE WITH THE SECURITIES AND EXCHANGE COMMISSION AND THE CURRENT "PROCEDURES" OF DTC TO BE FOLLOWED IN DEALING WITH DTC PARTICIPANTS ARE ON FILE WITH DTC.

NEITHER THE BOARD, THE UNIVERSITY, THE TRUSTEE NOR THE UNDERWRITER WILL HAVE ANY RESPONSIBILITY OR OBLIGATIONS TO SUCH DTC PARTICIPANTS OR THE BENEFICIAL OWNERS WITH RESPECT TO (i) THE BONDS; (ii) THE ACCURACY OF ANY RECORDS MAINTAINED BY DTC OR ANY DTC PARTICIPANT; (iii) THE PAYMENT BY ANY DTC PARTICIPANT OF ANY AMOUNT DUE TO ANY BENEFICIAL OWNER IN RESPECT OF THE PRINCIPAL AMOUNT OF OR INTEREST ON THE BONDS; (iv) THE DELIVERY BY ANY DTC PARTICIPANT OF ANY NOTICE TO ANY BENEFICIAL OWNER WHICH IS REQUIRED OR PERMITTED UNDER THE TERMS OF THE BOND RESOLUTION TO BE GIVEN TO BONDHOLDERS; (v) THE SELECTION OF THE BENEFICIAL OWNERS TO RECEIVE PAYMENT IN THE EVENT OF ANY PARTIAL REDEMPTION OF THE BONDS; OR (vi) ANY CONSENT GIVEN OR OTHER ACTION TAKEN BY DTC AS BONDHOLDER.

LSU

LOUISIANA STATE UNIVERSITY

ESCROW AGREEMENT
(Series 2012, Series 2013, Series 2014 and Series 2016A)

By and Between

**BOARD OF SUPERVISORS OF
LOUISIANA STATE UNIVERSITY AND
AGRICULTURAL AND MECHANICAL COLLEGE**

and

THE BANK OF NEW YORK MELLON TRUST COMPANY, N.A.,

as Escrow Trustee

Dated _____, 2022

**Executed as Part of the Proceedings
for the Refunding and Defeasance
of All or a Portion of the Following Issues of Bonds:**

**Board of Supervisors of Louisiana State University
And Agricultural and Mechanical College**

\$41,615,000
original aggregate principal amount of
Auxiliary Revenue Refunding Bonds
Series 2012

\$101,180,000
original aggregate principal amount of
Auxiliary Revenue Bonds
Series 2013

\$81,880,000
original aggregate principal amount of
Auxiliary Revenue Refunding Bonds
Series 2014

\$137,000,000
original aggregate principal amount of
Auxiliary Revenue Refunding Bonds
Series 2016A

ESCROW AGREEMENT
(Series 2012, Series 2013, Series 2014 and Series 2016A)

TABLE OF CONTENTS

* * * * *

SECTION. 1	Creation of the Escrow Deposit Fund.....	2
SECTION. 2	Deposits to Escrow Fund.....	3
SECTION. 3	Application of the Escrow Fund.....	3
SECTION. 4	Release of Lien of Refunded Bond Resolution.....	4
SECTION. 5	Irrevocable Trust.....	5
SECTION. 6	Fees and Expenses.....	5
SECTION. 7	Amendment of this Escrow Agreement.....	5
SECTION. 8	Termination of this Escrow Agreement.....	5
SECTION. 9	Benefit of this Escrow Agreement.....	5
SECTION. 10	Insufficient Moneys or Investments in the Escrow Fund.....	6
SECTION. 11	Examination of Records; Obligations and Responsibilities of Escrow Trustee.....	6
SECTION. 12	Resignation or Removal of the Escrow Trustee; Successor Escrow Trustees.....	7
SECTION. 13	Severability.....	8
SECTION. 14	Successors and Assigns.....	8
SECTION. 15	Governing Law.....	8
SECTION. 16	Headings.....	8
SECTION. 17	Counterparts.....	9
SECTION. 18	Verification of the Escrow Fund.....	9
SECTION. 19	Notices.....	9

* * * * *

EXHIBIT A -	Description of Escrow Fund Portfolio of Defeasance Obligations and Escrow Cash Flow.....	A-1
EXHIBIT B -	CPA Verification of Escrow Fund.....	B-1
EXHIBIT C -	Form of Defeasance Opinion.....	C-1
EXHIBIT D-1 -	Form of Notice of Defeasance (Refunded 2012 Bonds).....	D-1-1
EXHIBIT D-2 -	Form of Notice of Defeasance (Refunded 2013 Bonds).....	D-2-1
EXHIBIT D-3 -	Form of Notice of Defeasance (Refunded 2014 Bonds).....	D-3-1
EXHIBIT D-4 -	Form of Notice of Defeasance (Refunded 2016A Bonds).....	D-4-1
EXHIBIT E -	Defeasance Obligations.....	E-1
EXHIBIT F -	Release of Lien of Bond Resolution of Trustee.....	F-1
EXHIBIT G -	Tables of Bonds to be Defeased and Redeemed.....	G-1

ESCROW AGREEMENT
(Series 2012, Series 2013, Series 2014 and Series 2016A)

THIS ESCROW AGREEMENT, dated as of the ____ day of _____, 2022 (this "Escrow Agreement"), by and between the BOARD OF SUPERVISORS OF LOUISIANA STATE UNIVERSITY AND AGRICULTURAL AND MECHANICAL COLLEGE (the "Board"), a public constitutional corporation of the State of Louisiana created and existing under the Constitution and laws of the State, and THE BANK OF NEW YORK MELLON TRUST COMPANY, N.A., a national banking association duly organized and existing under and by virtue of the laws of the United States of America, and having full and complete trust powers, with a corporate trust office located in Jacksonville, Florida, as escrow trustee hereunder (the "Escrow Trustee").

WITNESSETH:

WHEREAS, the Board heretofore issued (i) \$41,615,000 original aggregate principal amount of its Auxiliary Revenue Refunding Bonds, Series 2012 (the "Series 2012 Bonds"), currently outstanding in the aggregate principal amount of \$_____, which Series 2012 Bonds were issued pursuant to the General Bond Resolution adopted on June 17, 1994, as supplemented and amended (the "General Bond Resolution"), including, particularly, as supplemented by the Fifteenth Supplemental Resolution adopted by the Board at its meeting of June 8, 2012, and executed on August 7, 2012 (the "Fifteenth Supplemental Resolution" and, together with the General Bond Resolution, the "2012 Bond Resolution"), (ii) \$101,180,000 original aggregate principal amount of its Auxiliary Revenue Bonds, Series 2013 (the "Series 2013 Bonds"), currently outstanding in the aggregate principal amount of \$_____, which Series 2013 Bonds were issued pursuant to the General Bond Resolution, as supplemented by the Sixteenth Supplemental Resolution adopted by the Board at its meeting of March 18, 2013, and executed on April 25, 2013 (the "Sixteenth Supplemental Resolution" and, together with the General Bond Resolution, the "2013 Bond Resolution"), (iii) \$81,880,000 original aggregate principal amount of its Auxiliary Revenue Refunding Bonds, Series 2014 (the "Series 2014 Bonds"), currently outstanding in the aggregate principal amount of \$_____, which Series 2014 Bonds were issued pursuant to the General Bond Resolution, as supplemented by the Seventeenth Supplemental Resolution adopted by the Board at its meeting of September 12, 2014, and executed on October 16, 2014 (the "Seventeenth Supplemental Resolution" and, together with the General Bond Resolution, the "2014 Bond Resolution"), and (iv) \$137,000,000 original aggregate principal amount of its Auxiliary Revenue Refunding Bonds, Series 2016A (the "Series 2016A Bonds"), currently outstanding in the aggregate principal amount of \$_____, which Series 2016A Bonds were issued pursuant to the General Bond Resolution, as supplemented by the Eighteenth Supplemental Resolution adopted by the Board at its meeting of October 21, 2016, and executed on November 15, 2016 (the "Eighteenth Supplemental Resolution" and, together with the General Bond Resolution, the "2016A Bond Resolution"); and

WHEREAS, the Board will issue, concurrently with the execution of this Escrow Agreement, \$_____ original aggregate principal amount of its Taxable Auxiliary Revenue Refunding Bonds, Series 2022 (the "Series 2022 Bonds"), which Series 2022 Bonds shall be issued and secured on a parity as to security and source of payment with the Outstanding Parity Bonds (as defined in the hereinafter defined 2022 Bond Resolution) (other than the hereinafter defined Refunded Bonds), in the manner authorized and provided by the Act (as

defined in the 2022 Bond Resolution) and the 2022 Bond Resolution for the purposes of providing funds^{***}, together with available funds of the Board,^{***} to (i) advance refund ^{***}all/a portion^{***} of the Board's outstanding Series 2012 Bonds, Series 2013 Bonds, Series 2014 Bonds and Series 2016A Bonds, as more particularly described herein, (ii) ^{***}pay the premium for the Insurance Policy (as defined in the 2022 Bond Resolution) and (iii)^{***} pay the costs of issuance of the Series 2022 Bonds; and

WHEREAS, the Series 2022 Bonds will be issued by the Board pursuant to the Act, the General Bond Resolution and the Twentieth Supplemental Resolution adopted by the Board on October 29, 2021 and executed on _____, 2022 (the "Twentieth Supplemental Resolution") and, together with the General Bond Resolution, the "2022 Bond Resolution"); and

WHEREAS, a portion of the proceeds of the Series 2022 Bonds^{***}, together with available moneys of the Board,^{***} will be applied as described herein for the advance refunding of ^{***}all/certain maturities^{***} of the outstanding Series 2012 Bonds (the "Refunded Series 2012 Bonds"), ^{***}all/certain maturities^{***} of the outstanding Series 2013 Bonds (the "Refunded Series 2013 Bonds"), ^{***}all/certain maturities^{***} of the outstanding Series 2014 Bonds (the "Refunded Series 2014 Bonds"), and ^{***}all/certain maturities^{***} of the outstanding Series 2016A Bonds (the "Refunded Series 2016A Bonds"), all as more particularly described in **Exhibit G** hereto (collectively, the "Refunded Bonds"); and

WHEREAS, at the present time, The Bank of New York Mellon Trust Company, N.A., serves as trustee with respect to (i) the Series 2012 Bonds (the "2012 Trustee") pursuant to the 2012 Bond Resolution, (ii) the Series 2013 Bonds (the "2013 Trustee") pursuant to the 2013 Bond Resolution, (iii) the Series 2014 Bonds (the "2014 Trustee" pursuant to the 2014 Bond Resolution and (iv) the Series 2016A Bonds (the "2016A Trustee" and, together with the 2012 Trustee, the 2013 Trustee and the 2014 Trustee, the "Refunded Bonds Trustee") pursuant to the 2016A Bond Resolution; and

WHEREAS, at the present time, The Bank of New York Mellon Trust Company, N.A. serves as trustee with respect to the Series 2022 Bonds (the "2022 Trustee") pursuant to the 2022 Bond Resolution; and

WHEREAS, it is the purpose and intent of this Escrow Agreement to provide for the application of certain moneys transferred to the Escrow Trustee that are derived from the proceeds of the Series 2022 Bonds and available funds of the Board, all in such manner as to cause the Refunded Bonds to be defeased and to be no longer deemed to be Outstanding pursuant to the requirements of the Refunded Bond Resolution; and

WHEREAS, all capitalized terms used herein and not otherwise defined herein shall have the same meanings set forth in the Refunded Bond Resolution and the 2022 Bond Resolution, as applicable; and

NOW, THEREFORE, in consideration of the mutual covenants herein contained, and in order to provide for the aforesaid defeasance of the Refunded Bonds in accordance with the Refunded Bond Resolution, the parties hereto covenant, agree and bind themselves as follows:

SECTION. 1 Creation of the Escrow Deposit Fund. There is hereby created by the Board in the custody of the Escrow Trustee and in the name of the Board a trust fund to be

designated "Board of Supervisors of Louisiana State University and Agricultural and Mechanical College Auxiliary Revenue Bonds, Series 2012, Series 2013, Series 2014 and Series 2016A Escrow Deposit Fund" (herein called the "Escrow Fund"). The Escrow Fund shall be held in trust as security for the payment of the principal of and interest on the Refunded Bonds and the redemption price of the Refunded Bonds to the owners thereof by the Escrow Trustee separate and apart from any other funds and accounts of the Board, if any, held by the Escrow Trustee.

SECTION. 2 Deposits to Escrow Fund.

(a) The Escrow Trustee hereby acknowledges the receipt and deposit to the credit of the Escrow Fund, of the amount of \$_____ consisting of (i) \$_____ in immediately available funds representing a portion of the proceeds of the Series 2022 Bonds received from the 2022 Trustee under the 2022 Bond Resolution (the "Series 2022 Proceeds") and (ii) available funds of the Board in the amount of \$_____ received from the Refunded Bonds Trustee held under the Refunded Bond Resolution. The Escrow Trustee represents and acknowledges that it has used such deposits to purchase, on behalf of and at the direction of the Board, as evidenced hereby, Defeasance Obligations (as such term is defined in the Refunded Bond Resolution and in **Exhibit E** attached hereto) in the aggregate principal amount of \$_____ , all as described on **Exhibit A** attached hereto.

(b) The remaining amount deposited to the Escrow Fund of \$_____ in shall be held uninvested as part of the beginning cash balance in the Escrow Fund and applied by the Escrow Trustee as more fully described in **Exhibit A** to this Escrow Agreement.

SECTION. 3 Application of the Escrow Fund. The Board hereby authorizes and directs the Escrow Trustee to invest a portion of the Escrow Fund, as described in Section (2)(a) hereof, in the Defeasance Obligations. The Escrow Trustee, without further authorization or direction from the Board, shall collect the principal of and interest on the Defeasance Obligations and shall deposit the same to the Escrow Fund as more fully described in **Exhibit A** to this Escrow Agreement. Pursuant to the terms of the Refunded Bond Resolution, on the dates and in the amounts set forth in **Exhibit A**, the Escrow Trustee shall transfer to the Refunded Bond Trustee from the Escrow Fund the stated amounts required for the payment of the principal and interest coming due on the Refunded Bonds through and including, (a) with respect to the Refunded 2012 Bonds, July 1, 2022 (the "2012 Redemption Date"), and for the redemption of the Refunded Series 2012 Bonds on the 2012 Redemption Date, (b) with respect to the Refunded 2013 Bonds, July 1, 2023 (the "2013 Redemption Date"), and for the redemption of the Refunded Series 2012 Bonds on the 2013 Redemption Date, (c) with respect to the Refunded 2014 Bonds, July 1, 2024 (the "2014 Redemption Date"), and for the redemption of the Refunded Series 2014 Bonds on the 2014 Redemption Date, and (d) with respect to the Refunded 2016A Bonds, July 1, 2026 (the "2016A Redemption Date" and, together with the 2012 Redemption Date, 2013 Redemption Date and 2014 Redemption Date, the "Redemption Date"), and for the redemption of the Refunded Series 2016A Bonds on the 2016A Redemption Date.

The Escrow Trustee and the Refunded Bonds Trustee are hereby irrevocably directed and instructed to take all actions, including the giving of all required notices (of redemption and defeasance) necessary pursuant to Section 5.02 of the General Bond Resolution and Section 3.04

of the Refunded Bonds Resolution, to cause the Refunded Bonds to be optionally redeemed on the applicable Redemption Date in accordance with their terms.

The Escrow Trustee shall have no power or duty to invest any moneys held hereunder or to make substitutions of the Defeasance Obligations held hereunder or to sell, transfer or otherwise dispose of the Defeasance Obligations acquired hereunder except as provided in this Section 3. Moneys in the Escrow Fund shall, and the Escrow Trustee agrees such moneys will, be used solely for the purpose as above-described and the deposit of such moneys in the Escrow Fund shall be irrevocable, and the Escrow Trustee agrees it will not surrender or otherwise attempt to redeem or otherwise negotiate the investments in the Escrow Fund, except as they shall come due, unless such redemption or negotiation shall be in connection with the purchase of other Defeasance Obligations permitted hereunder and the Escrow Trustee shall have received (a) the written request of the Board which elaborates the procedures to be followed, (b) an opinion by an independent certified public accountant acceptable to the Escrow Trustee (the "Accountant") that after such reinvestment the principal amount of the substituted securities, together with the earnings thereon and any beginning cash balance that is being held uninvested, will be sufficient to pay, as the same become due, all principal of, premium and interest on the Refunded Bonds which have not then previously been paid in accordance with the provisions of **Exhibit A** attached hereto, (c) an unqualified opinion of Bond Counsel or special tax counsel (acceptable to the Board) to the effect that (i) such reinvestment will not adversely affect the excludability of interest on the Refunded Bonds from gross income for federal income tax purposes, and (ii) such reinvestment complies with the provisions of all relevant documents relating to the issuance of the Series 2022 Bonds and the Refunded Bonds. Any investment earnings resulting from the reinvestment of proceeds of the Defeasance Obligations as described herein shall be transferred to the Board after the termination of this Escrow Agreement as set forth in Section 8 hereof. Subject to the foregoing requirements for the use of the Escrow Fund and the moneys and investments therein, the Board covenants and agrees that the Escrow Trustee shall have full and complete control and authority over and with respect to the Escrow Fund and moneys and investments therein and that the Board shall not exercise any control or authority over and with respect to the Escrow Fund and the moneys and investments therein.

The Refunded Bonds Trustee shall deliver to the Board within thirty (30) days after each Interest Payment Date on the Refunded Bonds (i.e., each January 1 and July 1) of each year, a report of each transaction relating to the Escrow Fund.

SECTION. 4 Release of Lien of Refunded Bond Resolution. In reliance upon the report and opinion of [****Causey, Demgen & Moore P.C., independent certified public accountants,****] dated of even date herewith, referred to in Section 18 hereof and upon the opinion of Breazeale, Sachse & Wilson, L.L.P., as Bond Counsel, dated of even date herewith, attached hereto as **Exhibit C**, and delivered to certain parties, the Refunded Bonds Trustee hereby acknowledges that the moneys and investments in the Escrow Fund satisfy the requirements of the Refunded Bond Resolution relating to the defeasance of the Refunded Bonds and agrees to deliver to the Board forthwith such instruments as are requested of it to evidence the Refunded Bonds Trustee's release of the lien of the Refunded Bond Resolution and the documents relating thereto with respect to the Refunded Bonds, including, but not limited to the Release of Lien of Refunded Bond Resolution of Refunded Bonds Trustee attached hereto as **Exhibit F**. Notwithstanding the fact that the liens of the Refunded Bond Resolution have been released with respect to the Refunded Bonds, the Refunded Bonds Trustee shall continue to

perform those duties under the Refunded Bond Resolution that are necessary in order to preserve and protect the interests of the owners of the Refunded Bonds defeased hereby.

SECTION. 5 Irrevocable Trust. The trust and fiduciary relationship created by this Escrow Agreement is irrevocable and intended for the benefit of the registered owners from time to time of the Refunded Bonds defeased hereby and the moneys derived from the interest on and principal of the investments in the Escrow Fund, are hereby dedicated and pledged for the payment of the principal of and premium and interest on the Refunded Bonds defeased hereby, and such moneys are subject to the lien of such pledge, which is valid and binding against all parties having claims of any kind against the Board, the Refunded Bonds Trustee or the Escrow Trustee. Such moneys and investments shall be used for the purposes herein stated, and the lien and security of this Escrow Agreement shall take effect from the date hereof without regard to the date of actual execution and delivery of this Escrow Agreement and shall remain in full force and effect until the terms of this Escrow Agreement have been satisfied and the moneys and the investments in the Escrow Fund have been applied as herein contemplated.

SECTION. 6 Fees and Expenses. The Board agrees to pay from moneys other than those in the Escrow Fund the Escrow Trustee's reasonable and customary administrative fees and to reimburse the Escrow Trustee for its reasonable and customary out-of-pocket expenses (including all publication expenses, if any, required by this Escrow Agreement) and reasonable fees of counsel incurred in connection with the discharge by the Escrow Trustee of its duties and responsibilities under this Escrow Agreement. The Escrow Trustee expressly waives any lien upon or claim against the moneys and investments in the Escrow Fund. Under no circumstances shall the Escrow Trustee have a lien on the Escrow Fund for its ongoing reasonable and customary charges, fees and expenses, and under no circumstances shall the Escrow Trustee make any claim against the Escrow Fund for such ongoing reasonable and customary charges, fees or expenses.

SECTION. 7 Amendment of this Escrow Agreement. This Escrow Agreement may only be amended, supplemented or modified upon receipt of an instrument executed by the Board and the Escrow Trustee and, to the extent that the obligations of the Refunded Bonds Trustee are affected thereby, by the Refunded Bonds Trustee.

SECTION. 8 Termination of this Escrow Agreement. This Escrow Agreement shall terminate when the Refunded Bonds defeased hereby have been paid and discharged in accordance with the provisions hereof. If any Refunded Bonds defeased hereby are not presented for payment when due and payable, the nonpayment thereof shall not prevent the termination of this Escrow Agreement; funds for the payment of any nonpresented Refunded Bonds defeased hereby shall, upon termination of this Escrow Agreement, be held by the Escrow Trustee in accordance with the Refunded Bond Resolution. Any money or Defeasance Obligations held in the Escrow Fund at termination and not required for the payment of the principal of and premium and interest on any of the Refunded Bonds defeased hereby shall be paid or transferred to the Board.

SECTION. 9 Benefit of this Escrow Agreement. This Escrow Agreement shall inure to the benefit of and shall be binding upon the Board, the Escrow Trustee, the Refunded Bonds Trustee, the registered owners of the Refunded Bonds defeased hereby and their respective successors and assigns subject to the provisions of this Escrow Agreement. In addition, this Escrow Agreement shall constitute a third party beneficiary contract for the benefit

of the Refunded Bonds Trustee and each registered owner of a Refunded Bond that has been defeased hereby (but only with respect to its rights to the payment of principal of, premium, if any, and interest on the Refunded Bonds). Each such third party beneficiary shall be entitled to enforce the performance and observance by the Board and the Escrow Trustee of the respective agreements and covenants herein contained as fully and completely as if such third party beneficiary were a party hereto.

Any bank into which the Escrow Trustee may be merged or with which it may be consolidated or any bank resulting from any merger or consolidation to which it shall be a party or any bank to which it may sell or transfer all or substantially all of its corporate trust business shall, unless the Board disapproves in writing, be the successor escrow agent without the execution of any document or the performance of any further act. In the event the Board disapproves of the successor escrow agent resulting from any of the events described above, the Board shall immediately appoint any state or national bank authorized to serve in such capacity within the State of Louisiana which is an institution insured by the Federal Deposit Insurance Corporation and which has trust powers to be the successor escrow agent, whereupon such successor escrow agent shall immediately succeed to the respective agreements and covenants hereunder.

SECTION. 10 Insufficient Moneys or Investments in the Escrow Fund. The Escrow Trustee shall immediately notify the Board by certified or registered, first-class mail, postage prepaid, whenever, for any reason, the Escrow Trustee becomes aware that the funds or accounts created pursuant to this Escrow Agreement plus the securities and investments therein and interest on said securities and investments, as the same accrues, will be insufficient to pay the principal of and premium and interest on the Refunded Bonds that are being defeased hereby as the same become due and payable prior to and through the Redemption Date. The Board shall pay to the Escrow Trustee the amount of any such deficiency in immediately available funds immediately upon receipt of any such notice.

SECTION. 11 Examination of Records; Obligations and Responsibilities of Escrow Trustee.

(a) The Board shall have the right, at any time upon reasonable notice, to examine all of the Escrow Trustee's records regarding the status of the funds or accounts created pursuant to this Escrow Agreement, and the details of all income, investments, redemptions and withdrawals therefrom with respect to the funds or accounts created pursuant to this Escrow Agreement. After the Refunded Bonds have been paid in full, the Board shall obtain all records and files relating to this Escrow Agreement from the Escrow Trustee. The Board shall keep all of such records and files available for inspection for four years from the date on which the Refunded Bonds shall have been paid in full.

(b) The Escrow Trustee shall be under no obligation to inquire into or be in any way responsible for the performance or nonperformance by the Board of any of the Board's obligations, or to protect any of the Board's rights under any bond resolution or any of the Board's other contracts with or franchises or privileges from any state, parish, county, municipality or other governmental agency or with any corporation or individual. The Escrow Trustee shall not be liable for any act done or step taken or omitted by the

Escrow Trustee or any mistake of fact or law or for anything which the Escrow Trustee may do or refrain from doing, except for its negligence or its willful misconduct in the performance of any obligation imposed upon the Escrow Trustee hereunder. The Escrow Trustee shall not be responsible in any manner whatsoever for the recitals or statements of the Board contained herein, in the Refunded Bonds or any proceedings taken in connection therewith (excepting, in its capacity as Trustee under the Refunded Bond Resolution), as they are made solely by the Board. In the performance of its duties hereunder, the Escrow Trustee shall be entitled to the same protections and rights granted to the trustee in Article XI of the General Bond Resolution.

SECTION. 12 Resignation or Removal of the Escrow Trustee; Successor Escrow Trustees. The Escrow Trustee at the time acting hereunder may at any time resign and be discharged from the trust hereby created by giving written notice to the Board, the 2019 Trustee, the Refunded Bonds Trustee and each rating service which has issued a rating on the Refunded Bonds, and giving such notice to the registered owners of the Refunded Bonds in the same manner as required by the provisions of Article XI of the General Bond Resolution in connection with a resignation of the 2022 Trustee, not less than ninety (90) days prior to the date when the resignation is to take effect. Such resignation shall take effect immediately upon the acceptance by the Board of the resignation, the appointment of a successor Escrow Trustee (which may be a temporary escrow trustee) by the Board, the acceptance by such successor Escrow Trustee of the terms, covenants and conditions of this Escrow Agreement, the transfer of the Escrow Fund, including the moneys and securities and investments held therein, to such successor Escrow Trustee and the completion of any other actions required for the principal of and interest on, the securities and investments to be made payable to such successor Escrow Trustee rather than the resigning Escrow Trustee.

The Escrow Trustee may also be removed for cause by the Board, which removal shall become effective upon the appointment of a successor Escrow Trustee (which may be a temporary successor escrow trustee) by the Board, the acceptance of such successor Escrow Trustee of the terms, covenants and conditions of this Escrow Agreement, the transfer of the Escrow Fund, including the moneys and securities and investments held therein, to such successor Escrow Trustee and the completion of any other actions required for the principal of and interest on the securities and investments to be made payable to such successor Escrow Trustee rather than the Escrow Trustee so being removed. The new Escrow Trustee shall give the notice of any such appointment as soon as practicable to the parties and in the same manner as is described in the first paragraph of this Section 12.

In the event the Escrow Trustee shall resign or be removed, or be dissolved, or shall be in the course of dissolution or liquidation, or otherwise become incapable of acting hereunder, or in case the Escrow Trustee shall be taken under the control of any public officer or officers, or of a receiver appointed by a court, the Board shall promptly appoint a temporary Escrow Trustee to fill such vacancy until a successor Escrow Trustee shall be appointed by the Board in the manner hereinabove provided, and any such temporary Escrow Trustee so appointed by the Board shall immediately and without further act be superseded by the successor Escrow Trustee so appointed. The new Escrow Trustee shall give the notice of any such appointment as soon as practicable to the parties and in the same manner as are described in the first paragraph of this Section 12.

No successor Escrow Trustee shall be appointed unless such successor Escrow Trustee shall be a corporation or association with trust powers organized under the banking laws of the United States of America or any state of the United States of America and shall have at the time of appointment capital and surplus of not less than \$75,000,000.

Every successor Escrow Trustee appointed hereunder shall execute, acknowledge and deliver to its predecessor, the Board and the Trustee, an instrument in writing accepting such appointment hereunder and thereupon such successor Escrow Trustee, without any further act, deed or conveyance, shall become fully vested with all the rights, immunities, powers, trusts, duties and obligations of its predecessor, but such predecessor shall, nevertheless, on the written request of such successor Escrow Trustee or the Board, execute and deliver an instrument transferring to such successor Escrow Trustee, all the estates, properties, rights, powers and trusts of such predecessor hereunder, and every predecessor Escrow Trustee shall deliver all securities and investments and moneys held by it to its successor. Should any transfer, assignment or instrument in writing from the Board be required by any successor Escrow Trustee for more fully and certainly vesting in such successor Escrow Trustee the estates, rights, powers and duties hereby vested or intended to be vested in the predecessor Escrow Trustee, any such transfer, assignment and instruments in writing shall, on request, be executed, acknowledged and delivered by the Board.

Any corporation into which the Escrow Trustee, or any successor to it in the trusts created by this Escrow Agreement, may be merged or converted or with which it or any successor to it may be consolidated, or any corporation resulting from any merger, conversion, consolidation or tax-free reorganization to which the Escrow Trustee or any successor to it shall be a party, shall, if satisfactory to the Board, be the successor Escrow Trustee under this Escrow Agreement without the execution or filing of any paper or any other act on the part of the parties hereto, anything herein to the contrary notwithstanding.

SECTION. 13 Severability. If any one or more of the covenants or agreements provided in this Escrow Agreement on the part of the Board or the Escrow Trustee to be performed should be determined by a court of competent jurisdiction to be contrary to law, such covenant or agreement shall be deemed and construed to be severable from the remaining covenants and agreements herein contained and shall in no way affect the validity of the remaining provisions of this Escrow Agreement.

SECTION. 14 Successors and Assigns. All of the covenants, promises and agreements in this Escrow Agreement contained by or on behalf of the Board or the Escrow Trustee shall bind and inure to the benefit of their respective successors and assigns, whether so expressed or not.

SECTION. 15 Governing Law. This Escrow Agreement shall be governed by the applicable law of the State of Louisiana.

SECTION. 16 Headings. Any headings preceding the text of the several Sections hereof shall be solely for convenience of reference and shall not constitute a part of this Escrow Agreement, nor shall they affect its meaning, construction or effect.

SECTION. 17 Counterparts. This Escrow Agreement may be executed in several counterparts, all or any of which shall be regarded for all purposes as one original and shall constitute and be but one and the same instrument.

SECTION. 18 Verification of the Escrow Fund. Set forth as **Exhibit B** and attached hereto and hereby incorporated by reference herein is a copy of the report prepared by **[**Causey Demgen & Moore P.C. independent certified public accountants**]**, dated of even date herewith, showing (a) the payments of the principal of and interest on the investments and moneys in the Escrow Fund, (b) the total of the principal of and premium and interest on the Refunded Bonds being defeased hereby required to be paid to and including the Redemption Date in the amounts and on the dates indicated, and (c) the cumulative balance in the Escrow Fund after each payment is made from the Escrow Fund. With the report, Causey Demgen & Moore Inc. has delivered its opinion, to be relied upon by the Board, the Refunded Bonds Trustee, the 2022 Trustee, the Escrow Trustee, the Underwriter and Breazeale, Sachse & Wilson, L.L.P. that, if the principal of and interest on the investments in the Escrow Fund are paid as said principal and interest become due, the proceeds from the collection of such interest and principal, together with any other moneys then required to be held in the Escrow Fund, will be sufficient to permit the prompt payment of the Refunded Bonds being defeased hereby as the same become due to and including the Redemption Date. The Escrow Trustee and the Refunded Bonds Trustee shall not be liable for the accuracy of any calculations as to the sufficiency of the investments and moneys in the Escrow Fund to pay the principal of, premium and interest on the Refunded Bonds or other calculations required to be made hereunder and shall not be liable for any deficiencies in the amounts necessary to make such payments, unless such deficiency is caused by the negligence, fault or intentional act of the Escrow Trustee and/or the Refunded Bonds Trustee.

SECTION. 19 Notices. Any notices, requests, complaints, demands, communications or other papers shall be sufficiently given and shall be deemed given when delivered or mailed by registered or certified mail, postage prepaid, or sent by email, telegram, telecopy or telex (or telephone to the extent permitted hereunder), addressed to the parties as follows or as provided by subsequent notice:

- | | |
|------------|--------------------------------------------------------------------------------------------------------------------------------------------------------------------------------|
| The Board: | (1) President
Louisiana State University
111 System Building
Baton Rouge, LA 70803
Facsimile: (225) 578-5524 |
| | (2) Executive Vice President
for Finance and Administration/CFO
Louisiana State University
330 Thomas Boyd Hall
Baton Rouge, LA 70803
Facsimile: (225) 578-5403 |

The Escrow Trustee, Refunded Bonds Trustee and 2022 Trustee	The Bank of New York Mellon Trust Company, N.A. 10161 Centurion Parkway Jacksonville, Florida 32256
-------------------------------------------------------------------	-----------------------------------------------------------------------------------------------------------

Attn: Corporate Trust Department
Facsimile: (904) 645-1921

Notice of Defeasance. The Board hereby irrevocably instructs the Refunded Bonds Trustee to give Notices of Defeasance of the Refunded Bonds, substantially in the forms attached as **Exhibits D-1, D-2, D-3** and **D-4** hereto, to be mailed to all record holders of the Refunded Bonds in accordance with the provisions of the Refunded Bond Resolution and to be posted on the Municipal Securities Rulemaking Board Electronic Municipal Market Access Center (EMMA). The Board will reimburse the Refunded Bonds Trustee for any expenses incurred in connection with this Section from moneys other than those in the Escrow Fund.

[remainder of page intentionally left blank]

[Signature Page to Escrow Agreement]

IN WITNESS WHEREOF, the Board has caused this Escrow Agreement to be executed by its duly authorized officer on this ____ day of _____, 2022.

**BOARD OF SUPERVISORS OF
LOUISIANA STATE UNIVERSITY AND
AGRICULTURAL AND MECHANICAL COLLEGE**

By _____

Name: Donna K. Torres

Title: Interim Executive Vice President
for Finance and Administration/CFO,
Louisiana State University

[Signature Page to Escrow Agreement]

IN WITNESS WHEREOF, the Escrow Trustee has caused this Escrow Agreement to be executed by its duly authorized officer on this ____ day of _____, 2022.

THE BANK OF NEW YORK MELLON TRUST
COMPANY, N.A., as Escrow Trustee

By _____
Name:
Title:

ACKNOWLEDGED AND ACCEPTED THIS ____ DAY OF _____, 2022:

THE BANK OF NEW YORK MELLON TRUST
COMPANY, N.A., as Refunded Bonds Trustee

By _____
Name:
Title:

BSW DRAFT
Version 1
EXHIBIT A
TO ESCROW AGREEMENT

**DESCRIPTION OF ESCROW FUND PORTFOLIO
OF DEFEASANCE OBLIGATIONS AND ESCROW CASH FLOW**

BSW DRAFT
Version 1
EXHIBIT B
TO ESCROW AGREEMENT

CPA VERIFICATION OF ESCROW FUND

BSW DRAFT
Version 1
EXHIBIT C
TO ESCROW AGREEMENT

DEFEASANCE OPINION

FORM OF NOTICE OF DEFEASANCE

**NOTICE TO OWNERS OF
Board of Supervisors of Louisiana State University
and Agricultural and Mechanical College
Auxiliary Revenue Refunding Bonds
Series 2012**

**issued in the original aggregate amount of \$41,615,000
and dated August 7, 2012**

<u>Maturity Date</u> <u>(July 1)</u>	<u>Interest Rate</u>	<u>Principal Amount</u>	<u>CUSIP</u>
-------------------------------------------------------	-----------------------------	--------------------------------	---------------------

NOTICE IS HEREBY GIVEN that the Board of Supervisors of Louisiana State University and Agricultural and Mechanical College (the "*Board*"), pursuant to a General Bond Resolution adopted June 17, 1994, as supplemented and amended (the "*General Bond Resolution*"), including, particularly by (i) a Fifteenth Supplemental Resolution adopted by the Board on June 8, 2012, and executed and effective on August 7, 2012 (the "*Fifteenth Supplemental Resolution*" and, together with the General Bond Resolution, the "*2012 Resolution*"), and (ii) a Twentieth Supplemental Resolution adopted by the Board on October 29, 2022, and effective on _____, 2022 (the "*Twentieth Supplemental Resolution*" and, together with the General Bond Resolution, the "*2022 Resolution*"), has caused to be deposited with The Bank of New York Mellon Trust Company, N.A., as escrow trustee (the "*Escrow Trustee*"), in trust and irrevocably set aside for such payment, cash and Defeasance Obligations, (as defined in the 2012 Resolution) pursuant to the Escrow Deposit Agreement (Series 2012, Series 2013, Series 2014 and Series 2016A) dated as of _____, 2022, between the Board and the Escrow Trustee (the "*Escrow Agreement*"), maturing as to principal and interest in such amount and at such times as will insure the availability of sufficient moneys to pay in full the outstanding Series 2012 Bonds described in the foregoing table (the "*Refunded Bonds*") (as separately verified by Causey Demgen & Moore Inc.), including funds sufficient to pay principal and interest on the Refunded Bonds through July 1, 2022, and sufficient to redeem all of the Refunded Bonds on July 1, 2022 (the "*Redemption Date*") at a redemption price equal to the par amount thereof, plus accrued interest to and including the Redemption Date. Notice is hereby given that the lien of the 2012 Resolution has been discharged and defeased by virtue of the

deposit to the Escrow Fund established by the Escrow Agreement of the cash and Defeasance Obligations referenced above.

The principal of, redemption premium, as applicable, and interest on the Refunded Bonds shall be paid by The Bank of New York Mellon Trust Company, N.A., as trustee for the Refunded Bonds (the "*Refunded Bonds Trustee*") in accordance with the terms of such Refunded Bonds.

A notice of redemption is required to be given by the Refunded Bonds Trustee at least 30 days, but not more than 60 days, prior to the Redemption Date in conformity with the provisions of the Refunded Bonds and the 2012 Resolution.

THE BANK OF NEW YORK MELLON TRUST COMPANY, N.A.,
as Refunded Bonds Trustee

Publication Date: _____, 20__

EXHIBIT D-2
TO ESCROW AGREEMENT

FORM OF NOTICE OF DEFEASANCE

**NOTICE TO OWNERS OF
Board of Supervisors of Louisiana State University
and Agricultural and Mechanical College
Auxiliary Revenue Bonds
Series 2013**

**issued in the original aggregate amount of \$101,180,000
and dated April 25, 2013**

Maturity Date <u>(July 1)</u>	<u>Interest Rate</u>	<u>Principal Amount</u>	<u>CUSIP</u>
------------------------------------------------	-----------------------------	--------------------------------	---------------------

NOTICE IS HEREBY GIVEN that the Board of Supervisors of Louisiana State University and Agricultural and Mechanical College (the "*Board*"), pursuant to a General Bond Resolution adopted June 17, 1994, as supplemented and amended (the "*General Bond Resolution*"), including, particularly by (i) a Sixteenth Supplemental Resolution adopted by the Board on March 8, 2013, and executed and effective on April 25, 2013 (the "*Sixteenth Supplemental Resolution*" and, together with the General Bond Resolution, the "*2013 Resolution*"), and (ii) a Twentieth Supplemental Resolution adopted by the Board on October 29, 2021, and effective on _____, 2022 (the "*Twentieth Supplemental Resolution*" and, together with the General Bond Resolution, the "*2022 Resolution*"), has caused to be deposited with The Bank of New York Mellon Trust Company, N.A., as escrow trustee (the "*Escrow Trustee*"), in trust and irrevocably set aside for such payment, cash and Defeasance Obligations, as defined in the 2013 Resolution, pursuant to the Escrow Agreement (Series 2012, Series 2013, Series 2014 and Series 2016A) dated as of _____, 2022, between the Board and the Escrow Trustee (the "*Escrow Agreement*"), maturing as to principal and interest in such amount and at such times as will insure the availability of sufficient moneys to pay in full the outstanding Series 2013 Bonds described in the foregoing table (the "*Refunded Bonds*") (as separately verified by Causey Demgen & Moore Inc.), including funds sufficient to pay principal and interest on the Refunded Bonds through July 1, 2023 and to optionally redeem all of the Refunded Bonds on July 1, 2023 (the "*Redemption Date*") at a redemption price equal to the par amount thereof, plus accrued interest to and including the Redemption Date. Notice is hereby given that the lien of the 2013 Resolution has been discharged with respect to the Refunded

Bonds and the Refunded Bonds have been defeased by virtue of the deposit to the Escrow Fund established by the Escrow Agreement of the cash and Defeasance Obligations referenced above.

The principal of, redemption premium, as applicable, and interest on the Refunded Bonds shall be paid by The Bank of New York Mellon Trust Company, N.A., as trustee for the Refunded Bonds (the "*Refunded Bonds Trustee*") in accordance with the terms of such Refunded Bonds.

A notice of redemption is required to be given by the Refunded Bonds Trustee at least 30 days, but not more than 60 days, prior to the Redemption Date in conformity with the provisions of the Refunded Bonds and the 2013 Resolution.

THE BANK OF NEW YORK MELLON TRUST COMPANY, N .A.,
as Refunded Bonds Trustee

Publication Date: _____, 20__

FORM OF NOTICE OF DEFEASANCE

**NOTICE TO OWNERS OF
Board of Supervisors of Louisiana State University
and Agricultural and Mechanical College
Auxiliary Revenue Refunding Bonds
Series 2014**

**issued in the original aggregate amount of \$80,880,000
and dated October 16, 2014**

<u>Maturity Date</u> <u>(July 1)</u>	<u>Interest Rate</u>	<u>Principal Amount</u>	<u>CUSIP</u>
-------------------------------------------------------	-----------------------------	--------------------------------	---------------------

NOTICE IS HEREBY GIVEN that the Board of Supervisors of Louisiana State University and Agricultural and Mechanical College (the "*Board*"), pursuant to a General Bond Resolution adopted June 17, 1994, as supplemented and amended (the "*General Bond Resolution*"), including, particularly by (i) a Seventeenth Supplemental Resolution adopted by the Board on September 12, 2014, and executed and effective on October 16, 2014 (the "*Seventeenth Supplemental Resolution*" and, together with the General Bond Resolution, the "*2014 Resolution*"), and (ii) a Twentieth Supplemental Resolution adopted by the Board on October 29, 2021, and effective on _____, 2022 (the "*Twentieth Supplemental Resolution*" and, together with the General Bond Resolution, the "*2022 Resolution*"), has caused to be deposited with The Bank of New York Mellon Trust Company, N.A., as escrow trustee (the "*Escrow Trustee*"), in trust and irrevocably set aside for such payment, cash and Defeasance Obligations, as defined in the 2014 Resolution, pursuant to the Escrow Agreement (Series 2012, Series 2013, Series 2014 and Series 2016A) dated as of _____, 2022, between the Board and the Escrow Trustee (the "*Escrow Agreement*"), maturing as to principal and interest in such amount and at such times as will insure the availability of sufficient moneys to pay in full the outstanding Series 2014 Bonds described in the foregoing table (the "*Refunded Bonds*") (as separately verified by Causey Demgen & Moore Inc.), including funds sufficient to pay principal and interest on the Refunded Bonds through July 1, 2024 and to optionally redeem all of the Refunded Bonds on July 1, 2024 (the "*Redemption Date*") at a redemption price equal to the par amount thereof, plus accrued interest to and including the Redemption Date. Notice is hereby given that the lien of the 2014 Resolution has been discharged with respect to the Refunded Bonds and the Refunded Bonds have been defeased by virtue of the deposit to the Escrow Fund established by the Escrow Agreement of the cash and Defeasance Obligations referenced above.

The principal of, redemption premium, as applicable, and interest on the Refunded Bonds shall be paid by The Bank of New York Mellon Trust Company, N.A., as trustee for the Refunded Bonds (the "*Refunded Bonds Trustee*") in accordance with the terms of such Refunded Bonds.

A notice of redemption is required to be given by the Refunded Bonds Trustee at least 30 days, but not more than 60 days, prior to the Redemption Date in conformity with the provisions of the Refunded Bonds and the 2014 Resolution.

THE BANK OF NEW YORK MELLON TRUST COMPANY, N .A.,
as Refunded Bonds Trustee

Publication Date: _____, 20__

FORM OF NOTICE OF DEFEASANCE

**NOTICE TO OWNERS OF
Board of Supervisors of Louisiana State University
and Agricultural and Mechanical College
Auxiliary Revenue Refunding Bonds
Series 2016A**

**issued in the original aggregate amount of \$137,000,000
and dated November 15, 2016**

<u>Maturity Date</u> <u>(July 1)</u>	<u>Interest Rate</u>	<u>Principal Amount</u>	<u>CUSIP</u>
-------------------------------------------------------	-----------------------------	--------------------------------	---------------------

NOTICE IS HEREBY GIVEN that the Board of Supervisors of Louisiana State University and Agricultural and Mechanical College (the "*Board*"), pursuant to a General Bond Resolution adopted June 17, 1994, as supplemented and amended (the "*General Bond Resolution*"), including, particularly by (i) an Eighteenth Supplemental Resolution adopted by the Board on October 21, 2016, and executed and effective on November 15, 2016 (the "*Eighteenth Supplemental Resolution*" and, together with the General Bond Resolution, the "*2016A Resolution*"), and (ii) a Twentieth Supplemental Resolution adopted by the Board on October 29, 2021, and effective on _____, 2022 (the "*Twentieth Supplemental Resolution*" and, together with the General Bond Resolution, the "*2022 Resolution*"), has caused to be deposited with The Bank of New York Mellon Trust Company, N.A., as escrow trustee (the "*Escrow Trustee*"), in trust and irrevocably set aside for such payment, cash and Defeasance Obligations, as defined in the 2016A Resolution, pursuant to the Escrow Agreement (Series 2012, Series 2013, Series 2014 and Series 2016A) dated as of _____, 2022, between the Board and the Escrow Trustee (the "*Escrow Agreement*"), maturing as to principal and interest in such amount and at such times as will insure the availability of sufficient moneys to pay in full the outstanding Series 2016A Bonds described in the foregoing table (the "*Refunded Bonds*") (as separately verified by Causey Demgen & Moore Inc.), including funds sufficient to pay principal and interest on the Refunded Bonds through July 1, 2026 and to optionally redeem all of the Refunded Bonds on July 1, 2026 (the "*Redemption Date*") at a redemption price equal to the par amount thereof, plus accrued interest to and including the Redemption Date. Notice is hereby given that the lien of the 2016A Resolution has been discharged with respect to the Refunded Bonds and the Refunded Bonds have been defeased by virtue of the deposit to the Escrow Fund established by the Escrow Agreement of the cash and Defeasance Obligations referenced above.

The principal of, redemption premium, as applicable, and interest on the Refunded Bonds shall be paid by The Bank of New York Mellon Trust Company, N.A., as trustee for the Refunded Bonds (the "*Refunded Bonds Trustee*") in accordance with the terms of such Refunded Bonds.

A notice of redemption is required to be given by the Refunded Bonds Trustee at least 30 days, but not more than 60 days, prior to the Redemption Date in conformity with the provisions of the Refunded Bonds and the 2016A Resolution.

THE BANK OF NEW YORK MELLON TRUST COMPANY, N .A.,
as Refunded Bonds Trustee

Publication Date: _____, 20__

BSW DRAFT
Version 1
EXHIBIT E
TO ESCROW AGREEMENT

DEFEASANCE OBLIGATIONS

BSW DRAFT
Version 1
EXHIBIT F
TO ESCROW AGREEMENT

RELEASE OF LIEN OF REFUNDED BOND RESOLUTION

The Refunded Bonds Trustee, in reliance upon various opinions and reports presented to it, hereby acknowledges pursuant to the Refunded Bond Resolution and Section 4 of this Escrow Agreement that, as a result of the deposit of the moneys and investments contained in the Escrow Fund created hereunder, it does hereby release and discharge the liens of the Refunded Bond Resolution. Notwithstanding the fact that the liens of the Refunded Bond Resolution have been released, the Refunded Bonds Trustee shall continue to perform those duties under the Refunded Bond Resolution that are necessary in order to preserve and protect the interests of the Refunded Bonds defeased hereby. Capitalized terms used, and not otherwise defined, in this Release of Lien of Refunded Bond Resolution ("*Release*") shall have the meanings assigned thereto in that certain Escrow Agreement (Series 2012, Series 2013, Series 2014 and Series 2016A) dated _____, 2022, by and between The Bank of New York Mellon Trust Company, N.A., as escrow trustee, and the Board of Supervisors of Louisiana State University and Agricultural and Mechanical College, to which this Release is attached as an Exhibit.

Dated this _____ day of _____, 2022.

THE BANK OF NEW YORK MELLON TRUST
COMPANY, N.A., as Refunded Bonds Trustee

By _____
Name:
Title:

TABLES OF BONDS TO BE DEFEASED AND REDEEMED

REFUNDED BONDS - SERIES 2012
BOARD OF SUPERVISORS OF
LOUISIANA STATE UNIVERSITY AND
AGRICULTURAL AND MECHANICAL COLLEGE
AUXILIARY REVENUE REFUNDING BONDS
SERIES 2012

Maturity Date <u>(July 1)</u>	<u>Interest Rate</u>	<u>Principal Amount</u>	<u>CUSIP</u>
------------------------------------------------	-----------------------------	--------------------------------	---------------------

REFUNDED BONDS - SERIES 2013

BOARD OF SUPERVISORS OF
LOUISIANA STATE UNIVERSITY AND
AGRICULTURAL AND MECHANICAL COLLEGE
AUXILIARY REVENUE BONDS
SERIES 2013

Maturity Date <u>(July 1)</u>	<u>Interest Rate</u>	<u>Principal Amount</u>	<u>CUSIP</u>
------------------------------------------------	-----------------------------	--------------------------------	---------------------

REFUNDED BONDS - SERIES 2014

**BOARD OF SUPERVISORS OF
LOUISIANA STATE UNIVERSITY AND
AGRICULTURAL AND MECHANICAL COLLEGE
AUXILIARY REVENUE REFUNDING BONDS
SERIES 2014**

Maturity Date <u>(July 1)</u>	<u>Interest Rate</u>	<u>Principal Amount</u>	<u>CUSIP</u>
------------------------------------------	-----------------------------	--------------------------------	---------------------

REFUNDED BONDS - SERIES 2016A

**BOARD OF SUPERVISORS OF
LOUISIANA STATE UNIVERSITY AND
AGRICULTURAL AND MECHANICAL COLLEGE
AUXILIARY REVENUE REFUNDING BONDS
SERIES 2016A**

Maturity Date <u>(July 1)</u>	<u>Interest Rate</u>	<u>Principal Amount</u>	<u>CUSIP</u>
------------------------------------------	-----------------------------	--------------------------------	---------------------

CONTINUING DISCLOSURE CERTIFICATE

[\$ _____]
BOARD OF SUPERVISORS OF LOUISIANA STATE UNIVERSITY
AND AGRICULTURAL AND MECHANICAL COLLEGE
TAXABLE AUXILIARY REVENUE REFUNDING BONDS
SERIES 2022

This Continuing Disclosure Certificate (the "*Disclosure Agreement*") constitutes the written undertaking of the Board of Supervisors of Louisiana State University and Agricultural and Mechanical College and its successors and assigns (the "*Board*"), for the benefit of the holders of the Board's [\$ _____] Taxable Auxiliary Revenue Refunding Bonds, Series 2022 (the "*Series 2022 Bonds*") required by Section (b)(5)(i) of Securities and Exchange Commission Rule 15c2-12 under the Securities Exchange Act of 1934, as amended (17 CFR Part 240, § 240.15c2-12) (the "*Rule*"). The Board is an "obligated person" within the meaning of the Rule. The Series 2022 Bonds will be issued pursuant to the General Bond Resolution adopted June 17, 1994, as supplemented and amended from time to time (the "*General Bond Resolution*"), and as supplemented by the Twentieth Supplemental Resolution adopted by the Board on October 29, 2021 (the "*Twentieth Supplemental Resolution*" and, together with the General Bond Resolution, the "*Bond Resolution*").

Section 1. Definitions. In addition to the definitions set forth in the Bond Resolution, which apply to any capitalized term used in this Disclosure Agreement unless otherwise defined in this Section, the following capitalized terms shall have the following meanings:

"*Annual Financial Information*" means the Audited Financial Statements and Operating Data.

"*Audited Financial Statements*" means the Board's annual financial report, prepared in accordance with GAAP, which financial report shall have been audited by an Accountant (which may be the Legislative Auditor).

"*Fiscal Year*" means the period commencing on the first day of July of any year and ending on the last day of June of the following year or such other period of twelve consecutive calendar months as shall be specified by the Board.

"*Financial Obligation*" shall mean a (i) debt obligation; (ii) derivative instrument entered into in connection with, or pledged as security or a source of payment for, an existing or planned debt obligation; or (iii) guarantee of (i) or (ii). The term "Financial Obligation" shall not include municipal securities (as defined in the Securities Exchange Act of 1934, as amended) as to which a final official statement (as defined in the Rule) has been provided to the MSRB consistent with the Rule.

"*Material Event*" means any of the following events with respect to the Bonds:

- (i) principal and interest payment delinquencies;
- (ii) non-payment related defaults, if material;
- (iii) unscheduled draws on debt service reserves reflecting financial difficulties;
- (iv) unscheduled draws on credit enhancements reflecting financial difficulties;

- (v) substitution of credit or liquidity providers, or their failure to perform;
- (vi) adverse tax opinions, material notices or determinations with respect to the tax status of the Series 2022 Bonds, or other material events affecting the tax status of the Series 2022 Bonds;
- (vii) modifications to rights of the owners of the Series 2022 Bonds, if material;
- (viii) bond calls, if material, and tender offers;
- (ix) defeasances;
- (x) release, substitution or sale of property securing repayment of the Bonds, if material;
- (xi) rating changes;
- (xii) bankruptcy, insolvency, receivership or similar event of the Board;¹
- (xiii) the consummation of a merger, consolidation or acquisition involving the Board or the sale of all or substantially all of the assets of the Board, other than in the ordinary course of business, the entry into a definitive agreement to undertake such an action or the termination of a definitive agreement relating to any such actions, other than pursuant to its terms, if material;
- (xiv) appointment of a successor or additional trustee or the change of name of a trustee, if material;
- (xv) incurrence of a Financial Obligation of the Board, if material, or agreement to covenants, events of default, remedies, priority rights, or other similar terms of a financial obligation of the Board, any of which affect holders of the Series 2022 Bonds, if material; and
- (xvi) default, event of acceleration, termination event, modification of terms, or other similar events under the terms of a Financial Obligation of the Board, any of which reflect financial difficulties.

"*Material Event Notice*" means the Notice required to be given in accordance with Section 4 hereof.

"*MSRB*" means the Municipal Securities Rulemaking Board, which has been designated by the Securities and Exchange Commission as the single centralized repository for the collection and availability of continuing disclosure documents for purposes of the Rule. The continuing disclosure documents must be provided to the MSRB in searchable portable document format (PDF) to the following:

¹ For the purposes of this event, the event is considered to occur when any of the following occur: the appointment of a receiver, fiscal agent or similar officer for the Board in a proceeding under the U.S. Bankruptcy Code or in any other proceeding under state or federal law in which a court or governmental authority has assumed jurisdiction over substantially all of the assets or business of the Board, or if such jurisdiction has been assumed by leaving the existing government body and officials or officers in possession but subject to the supervision and orders of a court or governmental authority, or the entry of an order confirming a plan of reorganization, arrangement or liquidation by a court or governmental authority having supervision or jurisdiction over substantially of the assets or business of the Board.

Municipal Securities Rulemaking Board
Electronic Municipal Market Access Center
www.emma.msrb.org

"*Operating Data*" means certain information pertaining to the operations of the University of the type contained in the Official Statement under the captions as described below and such similar or other information that the Board deems is relevant or necessary to comply with the Rule.

Official Statement	THE AUXILIARY ENTERPRISES HISTORICAL AUXILIARY REVENUES OUTSTANDING AUXILIARY REVENUE BONDS ANNUAL DEBT SERVICE REQUIREMENTS ON OUTSTANDING PARITY BONDS AND SERIES 2022 BONDS AND BASE RENTAL REQUIREMENTS ON SUBORDINATE LEASE OBLIGATIONS PROFORMA DEBT SERVICE AND BASE RENTAL COVERAGE RATIOS
Appendix A	DEMOGRAPHIC AND FINANCIAL INFORMATION CONCERNING THE UNIVERSITY

"*Participating Underwriter*" means any of the original underwriters of the Bonds required to comply with the Rule in connection with offering of the Bonds.

"*Rule*" means Rule 15c2-12(b)(5) adopted by the Securities and Exchange Commission under the Securities Exchange Act of 1934, as the same may be amended from time to time.

Section 2. Provision of Annual Financial Information.

(a) The Board shall, while any Bonds are Outstanding, provide the Annual Financial Information to the MSRB no later than April 30 of each year (the "*Report Date*") commencing April 30, 2022. The Board shall include with each submission of Annual Financial Information a written representation to the effect that the Annual Financial Information is the Annual Financial Information required by this Disclosure Agreement and that it complies with the applicable requirements of this Disclosure Agreement. The Board may adjust the Report Date if the Board changes its Fiscal Year by providing written notice of the change of Fiscal Year and the new Report Date to the MSRB; provided that the new Report Date shall be nine months after the end of the new Fiscal Year, and provided further that the period between the final Report Date relating to the former Fiscal Year and the initial Report Date relating to the new Fiscal Year shall not exceed one year in duration.

(b) If the Board is unable to provide to the MSRB the Operating Data by the date required in Section 2(a), the Board shall send a notice of Material Event to the MSRB within ten business days of such date.

(c) If the Board is unable to provide to the MSRB the Audited Financial Statements by the date required in Section 2(a), the Board shall provide to the MSRB unaudited financial statements of the Board, and, as required by the Rule, Audited Financial Statements, when and if available, must thereafter be provided to the MSRB.

Section 3. Content of Annual Financial Information. The Board's Annual Financial Information shall contain or incorporate by reference the Operating Data, as well as the following:

- (i) the Audited Financial Statements and

(ii) the accounting principles pursuant to which the Audited Financial Statements were prepared.

The Board reserves the right to cross-reference any or all of such annual financial information and operating data to other documents to be provided to the MSRB.

The Board reserves the right to modify from time to time the specific types of information provided or the format of the presentation of such information, to the extent necessary or appropriate in the judgment of the Board; provided that the Board agrees that any such modification will be done in a manner consistent with the Rule as provided in Section 6 hereof.

It shall be sufficient if the Board provides to the MSRB the Annual Financial Information by specific reference to documents previously provided to the MSRB or filed with the Securities and Exchange Commission and, if such document is a final official statement, available from the MSRB. The Board shall clearly identify each such other document so incorporated by reference.

Section 4. Reporting of Material Events.

(a) If a Material Event occurs while any Bonds are Outstanding, the Board shall provide a Material Event Notice directly to the MSRB in a timely manner not in excess of ten business days after the occurrence of the event. Each Material Event Notice shall be so captioned and shall prominently state the date, title and CUSIP numbers of the Bonds.

(b) The Trustee shall promptly advise the Board whenever, in the course of performing its duties as Trustee under the Indenture, the Trustee identifies an occurrence which, if material, would require the Board to provide a Material Event Notice pursuant to paragraph 4(a) above; provided that the failure of the Trustee so to advise the Board shall not constitute a breach by the Trustee of any of its duties and responsibilities hereunder or under the Indenture.

(c) The Board may from time to time choose to provide notice of the occurrence of certain other events, in addition to Material Events, if, in the judgment of the Board, such other event is material with respect to the Bonds, but the Board does not undertake to commit to provide any such notice of the occurrence of any material event except those listed above.

Section 5. Termination of Reporting Obligation. The Board's obligations under this Disclosure Agreement shall terminate upon the legal defeasance, prior redemption in whole or payment in full of all of the Bonds. In addition, any provision hereof and any provision relating to the Rule as set forth in the Bond Resolution shall be null and void in the event that the Board delivers to the Trustee an opinion of nationally recognized bond counsel to the effect that those portions of the Rule which require this Disclosure Agreement, or any such provision, are invalid, have been repealed retroactively or otherwise do not apply to the Bonds; provided that the Board shall have provided notice of such delivery and the cancellation of this Disclosure Agreement and that portion of the Bond Resolution relating to the Rule to the MSRB.

Section 6. Amendment; Waiver. Notwithstanding any other provision of this Disclosure Agreement, the Board may amend this Disclosure Agreement, and any provision of this Disclosure Agreement may be waived, if such amendment or waiver is supported by an opinion of counsel expert in federal securities laws to the effect that such amendment or waiver would not in and of itself cause the undertakings herein to violate, or adversely affect compliance with the Rule if such amendment or waiver had been effective on the date hereof, but taking into account any subsequent change in or official interpretation of the Rule.

Provided, however, that the following conditions must be satisfied prior to such amendment:

(a) the undertaking hereunder, as amended, would have complied with the requirements of the Rule at the time of the primary offering, after taking into account any amendments or interpretations of the Rule, as well as any change in circumstances; and

(b) the amendment does not materially impair the interests of the holders of the Bonds, as determined either by parties unaffiliated with the Board (such as bond counsel), or by approving vote of such holders in accordance with the terms of the Bond Resolution at the time of the amendment.

Further, the Annual Financial Information containing the amended operating data or financial information shall explain in narrative form, the reasons for the amendment and the impact of the change in the type of operating data or financial information being provided.

Further provided, if an amendment is made to an undertaking hereunder specifying the accounting principles to be followed in preparing the Audited Financial Statements, the Annual Financial Information for the year in which the change is made should present a comparison between the Audited Financial Statements or information prepared on the basis of the new accounting principles and those prepared on the basis of the former accounting principles. The comparison should include a qualitative discussion of the differences in the accounting principles and the impact of the change in the accounting principles on the presentation of the Audited Financial Statements, in order to provide information to investors to enable them to reevaluate the ability of the Board to meet its obligations. To the extent reasonably feasible, the comparison also should be quantitative. A notice of the change in the accounting principles should be sent to the MSRB.

Section 7. Additional Information. Nothing in this Disclosure Agreement shall be deemed to prevent the Board from disseminating any other information, using the means of dissemination set forth in this Disclosure Agreement or any other means of communication, or including any other information in any Annual Financial Information or Material Event Notice, in addition to that which is required by this Disclosure Agreement. If the Board chooses to include any information in any Annual Financial Information or Material Event Notice in addition to that which is specifically required by this Disclosure Agreement, the Board shall have no obligation under this Disclosure Agreement to update such information or include it in any future Annual Financial Information or Material Event Notice.

Section 8. Beneficiaries. This Disclosure Agreement shall inure solely to the benefit of the Board, the Participating Underwriter and the holders of the Bonds, and shall create no rights in any other person or entity.

[Remainder of Page Intentionally Left Blank]

IN FAITH WHEREOF, the undersigned has executed this Continuing Disclosure Certificate on this, the _____ day of _____, 2022.

BOARD OF SUPERVISORS OF LOUISIANA STATE
UNIVERSITY AND AGRICULTURAL AND
MECHANICAL COLLEGE

By: _____
Name: Donna K. Torres
Title: Interim Executive Vice President for Finance
and Administration/CFO

[\$ _____]
**BOARD OF SUPERVISORS OF
LOUISIANA STATE UNIVERSITY AND AGRICULTURAL
AND MECHANICAL COLLEGE
TAXABLE AUXILIARY REVENUE REFUNDING BONDS
SERIES 2022**

[_____, 2021]

Board of Supervisors of Louisiana State University
and Agricultural and Mechanical College
Baton Rouge, Louisiana

BOND PURCHASE AGREEMENT

On the basis of the representations contained in this Bond Purchase Agreement and upon the terms and conditions herein contained, the undersigned Raymond James & Associates, Inc., (the "*Underwriter*"), hereby offers to enter into this Bond Purchase Agreement (the "*Bond Purchase Agreement*") with the Board of Supervisors of Louisiana State University and Agricultural and Mechanical College (the "*Board*"). This offer is made subject to the Board's written acceptance of this Bond Purchase Agreement on or before 6:00 P.M., Central Time, on the date hereof, as authorized by the Board by its General Bond Resolution adopted on June 17, 1994, as supplemented and amended from time to time (the "*General Bond Resolution*"), and as supplemented by the Twentieth Supplemental Resolution approved by the Board on October 29, 2021 (the "*Twentieth Supplemental Resolution*" and, together with the General Bond Resolution, the "*Bond Resolution*"), and, if not so accepted and approved, will be subject to withdrawal by the Underwriter upon notice delivered to the Board at any time prior to the acceptance of this Bond Purchase Agreement by the Board.

All capitalized terms used herein and not otherwise defined herein shall have the same meanings ascribed to such terms in the Bond Resolution or the hereinafter defined Official Statement, unless the context shall clearly indicate otherwise.

SECTION 1. PURCHASE, SALE AND DELIVERY OF THE SERIES 2022 BONDS.

(a) Subject to the terms and conditions and in reliance upon the representations and agreements herein set forth, the Underwriter agrees to purchase from the Board, and the Board hereby agrees to sell and deliver to the Underwriter, all (but not less than all) of the Board's Taxable Auxiliary Revenue Refunding Bonds, Series 2022, in an aggregate principal amount of [\$ _____] (the "*Series 2022 Bonds*"). The Series 2022 Bonds shall bear interest at the rates per annum and mature on the dates and in the amounts set forth in the Official Statement (herein defined) and in **Exhibit A** hereto. The purchase price for the Series 2022 Bonds shall be [\$ _____] (representing [\$ _____] original principal amount of the Series 2022 Bonds, less [\$ _____] of net original issue discount, less [\$ _____] of Underwriter's discount). The scheduled payment of principal and interest on the Series 2022 Bonds when due will be guaranteed under a municipal bond insurance policy (the "*Insurance Policy*") to be issued concurrently with the delivery of the Series 2022 Bonds by Assured Guaranty Municipal Corp. (the "*Insurer*").

(b) Delivery of the Series 2022 Bonds shall be made in New York, New York, at the hereinafter defined Closing Time, through the facilities of The Depository Trust Company ("*DTC*"), 55 Water Street, New York, New York, or at such other place as shall be mutually agreed upon by the Board and the Underwriter. Subject to the terms hereof, it is expected that the Closing shall take place at 10:00 a.m., Baton Rouge, Louisiana time, on [_____, 2022] (or such other time or business day as may be mutually agreed upon by the Underwriter and the Board in writing) at the offices of Breazeale, Sachse & Wilson, L.L.P., One American Place, 23rd Floor, Baton Rouge, Louisiana 70821-3197. Payment for the Series 2022 Bonds shall be made in lawful money of the United States of America in immediately available federal funds and shall be payable to the Trustee (hereinafter defined) for the account of the Board at 10:00 a.m., Central Time on [_____, 2022], or such other date and time as shall be mutually agreed upon by the Board and the Underwriter. The date of such delivery and payment is herein called the "*Closing Date*," and the hour and date of such delivery and payment is herein called the "*Closing Time*." The Series 2022 Bonds shall be delivered in definitive or temporary form as fully registered bonds bearing CUSIP numbers in such denominations as the Underwriter shall specify. There shall be one Series 2022 Bond delivered for each series and maturity of the Series 2022 Bonds, registered in the name of Cede & Co., as nominee for DTC. Delivery of the Series 2022 Bonds shall be made at the office of the Trustee, and the Trustee shall hold the Series 2022 Bonds as custodian for DTC under its FAST system.

(c) The Series 2022 Bonds are to be issued by the Board pursuant to and in accordance with the provisions of the Constitution and laws of the State of Louisiana (the "*State*"), particularly Chapter 14-A of Title 39 of the Louisiana Revised Statutes of 1950, as amended (the "*Refunding Act*"), and the provisions of the Bond Resolution. The Series 2022 Bonds shall be described in and shall be issued and secured under and pursuant to the Bond Resolution, under which the principal of, redemption premium, if any, and the interest on the Series 2022 Bonds shall be payable from the Auxiliary Revenues of Louisiana State University and Agricultural and Mechanical College (the "*University*") and certain Funds and Accounts held by The Bank of New York Mellon Trust Company, N.A., [Baton Rouge, Louisiana], as trustee (the "*Trustee*"), as such Auxiliary Revenues may be modified from time to time, all as provided in the Bond Resolution. The Auxiliary Revenues are pledged by the Board to the payment of the Series 2022 Bonds pursuant to the Bond Resolution.

The Series 2022 Bonds are being issued on a parity with the Board's Outstanding Parity Bonds (as defined in the Bond Resolution).

The Series 2022 Bonds shall be special and limited obligations of the Board payable solely from [Auxiliary Revenues, the Lab School Revenues and the Recreational Sports Fee Revenues; provided that (i) the pledge of the Lab School Revenues will lapse on the later of (a) July 1, 2034 and (b) the maturity date of any Bonds issued to finance or refinance projects for the Lab School and (ii) the pledge of Recreational Sports Fee Revenues will lapse on the later of (a) July 1, 2043 and (b) the maturity date of any Bonds issued to finance or refinance projects for the Student Recreational Sports Complex]. The Series 2022 Bonds shall not constitute an indebtedness or pledge of the general credit of the University, the Board, the State or any political subdivision thereof within the meaning of any constitutional or statutory limitation of indebtedness and shall contain a recital to that effect. Neither the State nor any agency or political subdivision thereof, other than the Board, shall be obligated to pay the principal of the Series 2022 Bonds or the interest thereon, and the Series 2022 Bonds shall not be deemed to constitute a debt or liability of the State or any agency or political subdivision or agency thereof, other than the Board.

In the Twentieth Supplemental Resolution the Board (i) confirms the pledge of and does thereby pledge the [Lab School Revenues and Recreational Sports Fee Revenues, as Auxiliary Revenues, as security for the payment of all Bonds Outstanding under the General Bond Resolution and any Supplemental Resolutions until the later of (a) July 1, 2034, and (b) the maturity date of any Bonds issued to finance or refinance projects for the Lab School, and (ii) therein additionally confirms the pledge of, and does thereby

pledge, the Recreational Sports Fee Revenues as Auxiliary Revenues as security for the payment of all Bonds Outstanding under the General Bond Resolution and any Supplemental Resolutions until the later of (a) July 1, 2043, and (b) the maturity date of any Bonds issued to finance or refinance projects for the Student Recreational Sports Complex].

The Series 2022 Bonds are issuable as fully registered bonds, without coupons, in denominations of \$5,000 or any integral multiple thereof. The Series 2022 Bonds will be dated the date of delivery thereof and will bear interest from their dated date. Interest on the Series 2022 Bonds is payable on January 1 and July 1 of each year, commencing July 1, 2022 (each an "Interest Payment Date"), at the rates per annum set forth in **Exhibit B** hereto.

(d) The proceeds of the Series 2022 Bonds will be used by the Board, together with available funds of the Board, for the purpose of [(i) refunding and/or defeasing the Board's (a) outstanding Auxiliary Revenue Refunding Bonds, Series 2012 (the "*Series 2012 Refunded Bonds*"), (b) outstanding Auxiliary Revenue Bonds, Series 2013 maturing on July 1 in the years [____] through [____], inclusive, and [____] (the "*Series 2013 Refunded Bonds*"), (c) outstanding Auxiliary Revenue Refunding Bonds, Series 2014 maturing on July 1 in the years [____] through [____], inclusive, and [____] (the "*Series 2014 Refunded Bonds*"), and (d) outstanding Auxiliary Revenue Refunding Bonds, Series 2016A maturing on July 1, [____] (the "*Series 2016A Refunded Bonds*" and, together with the Series 2012 Refunded Bonds, the Series 2013 Refunded Bonds and the Series 2014 Refunded Bonds, the "*Refunded Bonds*") and (ii) paying the costs of issuance of the Series 2022 Bonds.]

In order to refund and/or defease the Refunded Bonds, a portion of the proceeds of the Series 2022 Bonds, together with available moneys of the Board, will be deposited and held pursuant to an Escrow Agreement dated the date of delivery of the Series 2022 Bonds (the "*Escrow Agreement*") between the Board and The Bank of New York Mellon Trust Company, N.A., as escrow agent (the "*Escrow Trustee*"). Concurrently with the delivery of the Series 2022 Bonds, certain proceeds thereof, together with available funds of the Board, shall be irrevocably deposited into the Escrow Fund pursuant to the Bond Resolution. The 2012 Bond Resolution, the 2013 Bond Resolution, the 2014 Bond Resolution and the 2016A Bond Resolution, and the Escrow Agreement require the Escrow Trustee to invest amounts deposited in the Escrow Fund in Defeasance Obligations described therein to effect a defeasance of the Refunded Bonds. The Escrow Fund, together with investment earnings thereon, shall be sufficient to pay (i) the principal and interest on the Series 2012 Refunded Bonds through the anticipated redemption date of July 1, 2022, (ii) the principal and interest on the Series 2013 Refunded Bonds through the anticipated redemption date of July 1, 2023, (iii) the principal and interest on the Series 2014 Refunded Bonds through the anticipated redemption date of July 1, 2024, and (iv) the principal and interest on the Series 2016A Refunded Bonds through the anticipated redemption date of July 1, 2026, as verified by Causey Demgen & Moore P.C., as verification agent, in its report to be dated on or before the date of delivery of the Series 2022 Bonds (herein, the "*Verification Report*").

The Refunded Bonds are described in Appendices G-1, G-2, G-3 and G-4 of the Official Statement.

(e) At or before the time of the Board's acceptance hereof, the Board shall have furnished the Underwriter with a copy of the Preliminary Official Statement of the Board relating to the Series 2022 Bonds, dated [_____, 2021] including the cover page and appendices thereto (the "*Preliminary Official Statement*"). The Board hereby represents that it has deemed the Preliminary Official Statement to have been final as of its date within the meaning of Rule 15c2-12 ("*Rule 15c2-12*") under the Securities Exchange Act of 1934, as amended and then in effect. The Board will deliver to the Underwriter as promptly as practicable, but in no event later than [_____, 2021], such number of copies of a final Official Statement, including the cover page and the appendices thereto (the "*Official Statement*") as the Underwriter

may reasonably require in order for the Underwriter to comply with the rules of the Municipal Securities Rulemaking Board ("*MSRB*") including, without limitation, Rule G-32 and Rule 15c2-12.

(f) The Board consents to the use by the Underwriter, prior to the date hereof, of the Preliminary Official Statement relating to the Series 2022 Bonds in connection with the public offering of the Series 2022 Bonds.

(g) The Board covenants and agrees to execute a Continuing Disclosure Certificate (the "*Continuing Disclosure Certificate*") constituting an undertaking to provide ongoing disclosure about the Board for the benefit of the bondholders on or before the date of delivery of the Series 2022 Bonds, in the form set forth in the Official Statement, with such changes as may be agreed to by the Underwriter.

SECTION 2. REPRESENTATIONS AND AGREEMENTS.

(a) By its execution hereof, the Board hereby represents and agrees with the Underwriter that:

(i) The Board is a public constitutional corporation, duly created pursuant to the provisions of Article VIII, Section 7(A) of the Constitution of the State of Louisiana. The Board is authorized by the laws of the State of Louisiana, including particularly the Refunding Act, and the Bond Resolution, (i) to issue, sell, execute and deliver the Series 2022 Bonds for the purposes specified herein, and (ii) to enter into and perform its obligations under the Bond Resolution, the Escrow Agreement, the Continuing Disclosure Certificate, the Blanket Letter of Representations to DTC (the "*Letter of Representations*"), and this Bond Purchase Agreement (collectively, the "*Board Documents*");

(ii) The Board has complied with all provisions of the Constitution and laws of the State, including the Refunding Act, pertaining to the adoption of the Bond Resolution, the issuance and sale of the Series 2022 Bonds and the execution and delivery of the Official Statement, the Board Documents and any and all of the other documents to which the Board shall be a party and agrees to carry out and consummate all transactions contemplated by each of the aforesaid documents;

(iii) As of the date thereof, the information contained in the Preliminary Official Statement (except for the information under the captions [BOND INSURANCE, TAX MATTERS, RATINGS, LEGAL MATTERS, UNDERWRITING, VERIFICATION OF COMPUTATIONS, APPENDIX C - PROPOSED FORM OF OPINION OF BOND COUNSEL, and APPENDIX H - BOOK-ENTRY ONLY SYSTEM and APPENDIX I – SPECIMEN BOND INSURANCE POLICY] (the "*Excluded Sections*") with respect to which the Board makes no representation) does not contain any untrue statement of a material fact or omit to state a material fact required to be stated therein or necessary to make the statements contained therein, in the light of the circumstances under which they were made, not misleading;

(iv) As of the date of this Bond Purchase Agreement and (unless an event occurs of the nature described in Section 2(a)(vi)) at all times subsequent thereto during the period from the date of this Bond Purchase Agreement to and including the date which is twenty-five (25) days following the End of the Underwriting Period for the Series 2022 Bonds (as determined in accordance with Section 10 hereof), the information contained in the Official Statement (except for the information under the Excluded Sections, with respect to which the Board makes no representation) does not and will not contain any untrue statement of a material fact or omit to state a material fact required to be stated therein or necessary to make the statements contained therein, in the light of the circumstances under which they were made, not misleading;

(v) If the Official Statement is supplemented or amended, at the time of each supplement or amendment thereto and (unless subsequently again supplemented or amended) at all times subsequent thereto during the period from the date of this Bond Purchase Agreement to and including the date which is twenty-five (25) days following the End of the Underwriting Period for the Series 2022 Bonds (as determined in accordance with Section 10 hereof), the information in the Official Statement (except for the information under the Excluded Sections, with respect to which the Board makes no representation) as so supplemented or amended will not contain any untrue statement of a material fact or omit to state a material fact required to be stated therein or necessary to make the statements contained therein, in the light of the circumstances under which they were made, not misleading;

(vi) If, during the period from the date of this Bond Purchase Agreement to and including the date which is twenty-five (25) days following the End of the Underwriting Period for the Series 2022 Bonds (as determined in accordance with Section 10 hereof), the Board becomes aware of any fact or event which might or would cause the Official Statement, as then supplemented or amended, to contain any untrue statement of a material fact or to omit to state a material fact required to be stated therein or necessary to make the statements contained therein, in the light of the circumstances under which they were made, not misleading, it shall notify the Underwriter, and if, in the opinion of the Underwriter, such fact or event requires the preparation and publication of a supplement or amendment to the Official Statement, the Board will, at its expense, supplement or amend the Official Statement in a form and in a manner approved by the Underwriter and furnish to the Underwriter (i) a reasonable number of copies of the supplement or amendment, and (ii) if such notification shall be subsequent to the Closing Date, such legal opinions, certificates, instruments, and other documents as the Underwriter may deem necessary to evidence the truth and accuracy of such supplement or amendment to the Official Statement;

(vii) The Board has duly authorized all action necessary to be taken for: (i) the issuance and sale of the Series 2022 Bonds upon the terms set forth herein and in the Official Statement; (ii) the use of the Official Statement by the Underwriter and the execution of the Official Statement by the Interim Executive Vice President for Finance and Administration/CFO of the University; and (iii) the execution, delivery and due performance of the Board Documents, the Series 2022 Bonds and any and all such other agreements and documents as may be required to be executed, delivered and received by the Board in order to carry out, give effect to and consummate the transactions contemplated hereby and by the Official Statement;

(viii) The Series 2022 Bonds and the Board Documents will each have been duly authorized, executed and delivered by the Board and, assuming the due authorization, execution and delivery by the other parties thereto, will each be valid and binding obligations of the Board in accordance with their respective terms;

(ix) The execution and delivery of the Series 2022 Bonds, the Board Documents and the other agreements contemplated hereby and by the Official Statement, and performance of the provisions thereof, will not conflict with or constitute a breach of or a default under any existing law, court or administrative regulation, decree or order or any agreement, indenture, mortgage, loan, rule or regulation or other instrument to which the Board is subject or by which the Board is or may be bound;

(x) Any certificate signed by any of the Authorized Board Representatives and delivered to the Underwriter shall be deemed a representation by the Board to the Underwriter as to the statements made therein;

(xi) The Series 2022 Bonds are limited and special obligations of the Board payable solely from and secured by a pledge of the Auxiliary Revenues, the Lab School Revenues and the Recreational Sports Fee Revenues of the University, to the extent provided in the Bond Resolution and on a parity with the Outstanding Parity Bonds;

(xii) Since the date of the financial report of the Louisiana State University System for the year ended June 30, 2020, contained in the Official Statement, there has not been any material adverse change in the properties, financial position or results of operations of the Board or the University, whether or not arising from transactions in the ordinary course of business and, since such date, the Board has not entered into any transaction or incurred any liability material to the Board, except to the extent such change, transaction or liability has been disclosed in the Official Statement;

(xiii) The Board is not in violation in any respect material to the transactions contemplated by the Bond Resolution and has not received notice of any claimed violation material to said transactions (except such violations as heretofore have been specifically disclosed in the Official Statement) of the current Bylaws and Regulations of the Board, or any laws, ordinances, governmental rules or regulations or court or other governmental orders or the terms of any agreement or other instruments to which it is a party or by which it, its properties or operations are bound;

(xiv) No consent, approval or authorization of, or filing, registration or qualification with, any governmental authority (other than those, if any, already obtained and other than any required under "Blue Sky" laws) is required on the part of the Board as a condition to the execution and delivery of the Board Documents or the performance of the Board's obligations under any of such documents;

(xv) The Board has all requisite power to issue the Series 2022 Bonds and has been duly authorized to execute and deliver the Series 2022 Bonds under the terms and provisions of the Bond Resolution;

(xvi) Neither the execution and delivery of the Series 2022 Bonds nor the fulfillment of or compliance with the terms and conditions of the Series 2022 Bonds or the Board Documents, except to the extent disclosed in the Official Statement, will conflict with or result in a breach of any of the material terms, conditions or provisions of, or will result, except to the extent disclosed in the Official Statement, in the creation or imposition of any material lien, charge or encumbrance upon any property or assets of the Board or the University pursuant to any indenture, ordinance, loan agreement or other agreement or instrument (other than liens, charges and encumbrances created by the Bond Resolution or the Outstanding Parity Bonds, as defined in the Bond Resolution) or corporate restrictions to which the Board is a party or by which the Board, or its properties or operations, may be bound, and such action will not, except to the extent disclosed in the Official Statement, result in any material violation of the Bylaws or Regulations of the Board or the provisions of any laws, ordinances, governmental rules or regulations or court or other governmental orders to which the Board or its properties or operations are subject;

(xvii) There is no litigation or governmental action, proceeding, inquiry or investigation pending or, to the knowledge of the Board, threatened by governmental authorities or others or to which the Board is a party or of which any property of the Board is subject or, to the knowledge of the Board, any basis for any such action, proceeding, inquiry or investigation, except for matters disclosed in the Official Statement, which, if determined adversely to the Board, would individually or in the aggregate (a) materially and adversely affect the validity or the enforceability of the Series 2022 Bonds or any Board Document or (b) otherwise materially adversely affect the ability of the

Board to comply with its obligations under the Series 2022 Bonds, the Board Documents or any related document. Except as provided in the Official Statement, no litigation, proceedings or investigations are pending or, to the knowledge of the Board, threatened against the Board, except for litigation, proceedings or investigations which the Board believes are nonmeritorious or that insurance coverage provided by applicable insurance policies is adequate to offset any significant liabilities that may result from such action and which would materially adversely affect the Board's ability to comply with its payment obligations under the Series 2022 Bonds;

(xviii) The representations of the Board set forth in the Bond Resolution will be true and correct in all material respects on the effective date thereof;

(xix) To the extent permitted by law, the Board agrees to reimburse the Underwriter, any member, trustee, officer, official or employee of the Underwriter and each person, if any, who controls the Underwriter within the meaning of Section 15 of the Securities Act of 1933, as amended (collectively, the "*Reimbursable Parties*"), for any and all losses, claims, damages, liabilities or expenses whatsoever to the extent caused by any untrue statement or misleading statement of a material fact contained in the Official Statement (other than in the Excluded Sections) concerning the Board or its properties or operations or caused by any omission from the Official Statement of any material fact concerning the Board or its properties or operations necessary in order to make the statements made therein, in light of the circumstances under which they were made, not misleading. In case any action shall be brought against one or more of the Reimbursable Parties based upon the Official Statement (other than with respect to information in the Excluded Sections) and in respect of which reimbursement may be sought against the Board, the Reimbursable Parties shall promptly notify the Board in writing, and the Board shall, to the extent permitted by law, promptly assume the defense thereof, including the employment of counsel, the payment of all reasonable expenses and the right to negotiate and consent to settlement. Any one or more of the Reimbursable Parties shall have the right to employ separate counsel in any such action and to participate in the defense thereof, but the fees and expenses of such counsel shall be at the expense of such Reimbursable Party or Reimbursable Parties unless employment of such counsel has been specifically authorized by the Board. The Board shall not be bound to make reimbursement for any settlement of any such action effected without its consent by any of the Reimbursable Parties, but, if settled with the consent of the Board or if there be a final judgment for the plaintiff in any such action against the Board or any of the Reimbursable Parties, with or without the consent of the Board, the Board agrees to reimburse the Reimbursable Parties to the extent provided by law and in this Bond Purchase Agreement;

(xx) The Board will deliver or cause to be delivered all opinions, certificates and other documents, as provided for in this Bond Purchase Agreement, including, but not limited to, an opinion of its counsel dated as of the Closing Date;

(xxi) The Board will apply the proceeds from the sale of the Series 2022 Bonds for the purposes specified in the Bond Resolution; and

(xxii) The Board hereby certifies that, to the best of its knowledge after a diligent review, it has timely complied with the continuing disclosure obligations under Section (b)(5) of the Rule with respect to each of its existing continuing disclosure undertakings.

(b) The Board will cooperate with the Underwriter in taking all necessary action for the qualification of the Series 2022 Bonds for sale and the determination of their eligibility for investment under the securities or Blue Sky laws of such jurisdictions as the Underwriter designates, with the exception of any jurisdiction where consent to local service of process in suits other than those arising out of the sale

of the Series 2022 Bonds is a prerequisite to such qualification and the continuation of such qualifications in effect so long as required for distribution of the Series 2022 Bonds.

(c) The representations and covenants of or by the Board contained in this Bond Purchase Agreement are given solely for the benefit of the Underwriter and the other Reimbursable Parties referred to herein and their respective successors, assigns, executors and administrators, and no other person, including any registered owner of the Series 2022 Bonds as such, shall acquire or have any right under or by virtue of this Bond Purchase Agreement.

SECTION 3. CONDITIONS TO THE UNDERWRITER'S OBLIGATIONS.

The Underwriter's obligations hereunder shall be subject to the accuracy of, and compliance with, the representations and agreements of the Board contained herein, as of the date hereof and as of the Closing Date, and are also subject to the following conditions:

(a) Concurrently with your acceptance hereof, you shall deliver or cause to be delivered to us an executed copy of this Bond Purchase Agreement.

(b) On the Closing Date, the Series 2022 Bonds (including any opinions attached thereto or printed thereon), the Board Documents, the Preliminary Official Statement and the Official Statement, shall have been duly adopted or authorized, executed and delivered as applicable, each in the form submitted to the Underwriter on the date hereof with only such changes therein as shall be mutually agreed upon by the Underwriter.

(c) At or before the Closing Time, the Underwriter shall have received:

(i) The opinions, addressed to the Underwriter, and in form and substance satisfactory to the Underwriter and its counsel, dated as of the Closing Date, or a letter, dated as of the Closing Date, addressed to the Underwriter, indicating that the Underwriter may rely upon such opinions as if the same were addressed to the Underwriter, of:

(A) Breazeale, Sachse & Wilson, L.L.P., Bond Counsel, substantially in the form attached as Appendix C to the Official Statement, together with the opinions required by Section 12.01 of the General Bond Resolution and a supplemental opinion each in form and substance satisfactory to the Board, the Underwriter and Underwriter's Counsel, a defeasance opinion addressed to the Escrow Trustee, the Trustee and the Underwriter and the opinions required by Section 13.02 of the General Bond Resolution;

(B) Foley & Judell, L.L.P., Underwriter's Counsel;

(C) Breazeale, Sachse & Wilson, LLP, Counsel to the Board, in form and substance satisfactory to the Board, the Underwriter, Underwriter's Counsel and Bond Counsel;

(D) Gregory A. Pletsch & Associates, APLC, Counsel to the Trustee, in form and substance satisfactory to the Board, the Underwriter, Underwriter's Counsel and Bond Counsel;

(E) Gregory A. Pletsch & Associates, APLC, Counsel to the Escrow Trustee, in form and substance satisfactory to the Board, the Underwriter, Underwriter's Counsel and Bond Counsel;

(ii) Evidence of the approval by the State Bond Commission of the State of the issuance of the Series 2022 Bonds by the Board;

(iii) Evidence satisfactory to the Underwriter that the Series 2022 Bonds have received an insured rating of ["AA"] from Standard & Poor's Global Ratings ("S&P") and underlying ratings of ["A2"] (Stable Outlook) and ["A+"] (Stable Outlook), respectively, from Moody's Investors Service Inc. ("Moody's") and Fitch Ratings ("Fitch") and that such ratings are in effect at the Closing Time; provided, however, the Underwriter in its sole discretion may waive this requirement as a precondition to Closing;

(iv) Specimen form of the Series 2022 Bonds;

(v) Certified copies of the General Bond Resolution and the Twentieth Supplemental Resolution;

(vi) A certificate of an Authorized Board Representative dated as of the Closing Date to the effect that:

(A) As of the date thereof, the information contained in the Official Statement (except for the information under the Excluded Sections) did not contain any untrue statement of a material fact or omit to state a material fact required to be stated therein or necessary to make the statements contained therein, in the light of the circumstances under which they were made, not misleading;

(B) As of the date of this Bond Purchase Agreement and at all times subsequent thereto up to and including the Closing Date, the information contained in the Official Statement (except for the information under the Excluded Sections) did not contain any untrue statement of a material fact or omit to state a material fact required to be stated therein or necessary to make the statements contained therein, in the light of the circumstances under which they were made, not misleading; and

(C) No litigation, except as described in the Official Statement, is pending or, to the knowledge of the Board, threatened, to restrain or enjoin the execution and delivery of the Series 2022 Bonds or the Board Documents or the existence or powers of the Board or the right of the Board to carry out the terms thereof; and the issuance of the Series 2022 Bonds and the execution and delivery of the other agreements contemplated hereby and by the Official Statement under the circumstances contemplated thereby and the compliance by the Board with the provisions thereof will not conflict with or constitute on the part of the Board a material breach of or a default under the By-Laws and Regulations of the Board, as amended, or any existing law, court or administrative regulation, decree or order or any agreement, indenture, mortgage, loan or other instrument to which the Board is subject or by which it is bound;

(vii) Executed deemed final certificate of the Board set forth in **Exhibit B** hereto;

(viii) An executed copy of the Continuing Disclosure Certificate;

(ix) A copy of the DTC Letter of Representations;

(x) A certificate of an authorized representative of the Trustee and Escrow Trustee to the effect that (A) each of the Trustee and the Escrow Trustee is a national banking association organized and existing under and by virtue of the laws of the United States of America and duly

authorized to accept and execute trusts, with a corporate trust office located in Baton Rouge, Louisiana, and in good standing under the laws of the United States of America and is duly authorized to exercise trust powers in the State, (B) each of the Trustee and the Escrow Trustee has full right, power and authority to accept the duties enumerated in the Bond Resolution and the Escrow Agreement and to perform its obligations under the Bond Resolution and the Escrow Agreement, (C) the Escrow Agreement constitutes the valid and binding obligation of the Escrow Trustee in accordance with its terms, subject to applicable bankruptcy, insolvency, reorganization, moratorium and other similar laws affecting creditors' rights generally and subject, as to enforceability, to general principles of equity, (D) the performance by the Trustee of its functions under the Bond Resolution and the Escrow trustee of its functions under the Escrow Agreement will not result in any violation of the incorporating documents or bylaws of the Trustee or Escrow Trustee, any court order to which the Trustee or Escrow Trustee is subject or any agreement, indenture or other obligation or instrument to which the Trustee or the Escrow Trustee is a party or by which the Trustee or Escrow Trustee is bound, and no approval or other action by any governmental authority or agency having supervisory authority over the Trustee or the Escrow Trustee, as applicable, is required to be obtained by the Trustee or Escrow Trustee in order to perform its functions under the Bond Resolution and the Escrow Agreement, and (E) to the best of such authorized representatives' knowledge, there is no action, suit, proceeding or investigation at law or in equity before any court, public board or body pending or, to his or her knowledge, threatened against or affecting the Trustee or Escrow Trustee wherein an unfavorable decision, ruling or finding on an issue raised by any party thereto is likely to materially and adversely affect the ability of the Trustee or Escrow Trustee to perform its respective obligations under the Bond Resolution and the Escrow Agreement;

(xi) Verification Report of Causey Demgen & Moore P.C.;

(xii) An executed copy of the Escrow Agreement;

(xiii) Such additional certificates, opinions and other documents as the Underwriter, Underwriter's Counsel or Bond Counsel may reasonably request to evidence performance of or compliance with the provisions of this Bond Purchase Agreement and the transactions contemplated hereby and by the Official Statement, all such certificates and other documents to be satisfactory in form and substance to the Underwriter and Underwriter's Counsel; and

(xiv) the Insurance Policy and documents related thereto as may be required by Bond Counsel and the Underwriter, including but not limited to an opinion of counsel to the Insurer in form and substance reasonably satisfactory to the Underwriter and its counsel.

SECTION 4. THE UNDERWRITER'S RIGHT TO CANCEL.

The Underwriter shall have the right to cancel its obligations hereunder to purchase the Series 2022 Bonds by notifying the Board in writing or by electronic means of its election to do so between the date hereof and the Closing Date, if at any time hereafter and prior to the Closing Time:

(i) Legislation shall be introduced in or enacted by the Congress of the United States or adopted by either House thereof or introduced in or enacted by the legislature of the State, or a decision by a federal court (including the Tax Court or Claims Court of the United States) or a State court shall be rendered, or a ruling, regulation (proposed, temporary or final) or statement by or on behalf of the Treasury Department of the United States, the Internal Revenue Service or other federal or State agency shall be made, with respect to the revenues and other property pledged to the payment of the Series 2022 Bonds or with respect to interest received on bonds of the general character of the Series 2022 Bonds, or which would have the effect of changing, directly or indirectly, the federal or State income tax consequences of interest

on bonds of the general character of the Series 2022 Bonds in the hands of the holders thereof, which legislation, ruling, regulation or official statement would, in the Underwriter's reasonable judgment, materially adversely affect the market price of the Series 2022 Bonds;

(ii) The marketability of the Series 2022 Bonds or the market price thereof, in the reasonable opinion of the Underwriter, has been materially and adversely affected by disruptive events, occurrences or conditions in the securities or debt markets, or any legislation, ordinance, rule, regulation or policy statement shall be introduced in or be enacted by any governmental body, department or agency in the State or the federal government, or a decision by any court of competent jurisdiction within the State or the federal government shall be rendered which, in the Underwriter's reasonable opinion, materially adversely affects the marketability of the Series 2022 Bonds or the market price of the Series 2022 Bonds;

(iii) A stop order, ruling, regulation or official statement by, or on behalf of, the Securities and Exchange Commission or any other governmental agency having jurisdiction of the subject matter shall be issued or made to the effect that the issuance, offering or sale of the obligations of the general character of the Series 2022 Bonds, or the issuance, offering or sale of the Series 2022 Bonds, including all underlying obligations, as contemplated hereby or by the Official Statement, is in violation or would be in violation of any provision of the Federal securities laws, including the Securities Act of 1933, as amended and as then in effect, or the registration provisions of the Securities Exchange Act of 1934, as amended and as then in effect, or the qualification provisions of the Trust Indenture Act of 1939, as amended and as then in effect;

(iv) Legislation shall be enacted by the Congress of the United States of America, or a decision by a court of the United States of America shall be rendered, to the effect that obligations of the general character of the Series 2022 Bonds are not exempt from registration under the Securities Act of 1933, as amended and as then in effect, or the Securities Exchange Act of 1934, as amended and as then in effect, or that the Bond Resolution as an indenture is not exempt from qualification under the Trust Indenture Act of 1939, as amended and as then in effect;

(v) Any event shall have occurred, or information become known, which, in the Underwriter's reasonable opinion, makes untrue in any material respect any statement or information contained in the Official Statement (as it may have been previously supplemented or amended) or has the effect that the Official Statement (as it may have been previously supplemented or amended) contains an untrue statement of a material fact or omits to state a material fact necessary in order to make the statements made therein, in light of the circumstances under which they were made, not misleading;

(vi) Additional material restrictions not in force as of the date hereof shall have been imposed upon trading in securities generally by any governmental authority or by any national securities exchange;

(vii) The New York Stock Exchange or other national securities exchange, or any governmental authority, shall impose, as to the Series 2022 Bonds or obligations of the general character of the Series 2022 Bonds, any material restrictions not now in force, or increase materially those now in force, with respect to the extension of credit by, or the charge to the net capital requirements of, underwriters such as the Underwriter;

(viii) A general banking moratorium shall have been established by federal, New York or State authorities;

(ix) Any proceeding shall be pending or threatened by the Securities and Exchange Commission against the Board;

(x) A war involving the United States of America shall have been declared, or any conflict involving the armed forces of the United States of America shall have escalated, or any other national

emergency relating to the effective operation of government or the financial community shall have occurred, which, in the Underwriter's reasonable opinion, materially adversely affects the market price of the Series 2022 Bonds;

(xi) The President of the United States of America, the Office of Management and Budget, the Department of the Treasury, the Internal Revenue Service, or any other governmental body, department or agency of the United States of America shall take or propose to take any action or implement or propose regulations or rulings which, in the Underwriter's reasonable opinion, materially adversely affect the market price of the Series 2022 Bonds, impact adversely in a material manner upon the Board's ability to apply the proceeds of the Series 2022 Bonds for the purposes for which the Series 2022 Bonds were authorized to be issued or causes the Official Statement (as it may have been previously supplemented or amended pursuant to Section 2(a)(vi) hereof) to be incorrect or misleading in any material respect;

(xii) The long term ratings assigned to the Series 2022 Bonds shall have been downgraded from ["AA"] by S&P (insured) or the Insurer is placed on "credit watch," ["A+"] (Stable Outlook) by Fitch (underlying) or ["A2"] (Stable Outlook) by Moody's (underlying), after the date hereof, the effect of which, in the reasonable judgment of the Underwriter, is to affect materially and adversely the market prices of the Series 2022 Bonds;

(xiii) The Board shall fail to deliver Official Statements to the Underwriter as provided in Section 1(e) hereof; provided, however, that the Underwriter may not terminate its obligations hereunder as a result of the failure of the Board to deliver such Official Statements unless such failure materially affects the Underwriter's marketing and sale of the Series 2022 Bonds or subjects the Underwriter to compliance infractions under the Securities and Exchange Commission or the MSRB delivery requirements;

(xiv) Failure by the Board to execute the Continuing Disclosure Certificate;

(xv) There shall have occurred, or any notice shall have been given of, any intended downgrading, suspension, withdrawal or negative change in credit watch status by any national rating service to any of the Boards obligations;

(xvi) The Insurance Policy of the Insurer shall have been repudiated by the Insurer or any litigation or proceeding shall be pending or threatened which questions the validity or enforceability thereof, or seeks to enjoin performance by the Insurer thereunder or the Board or the Underwriter shall have received notice from the Insurer that it will be unable to perform thereunder; or

(xvii) Any federal or state court, authority or administrative or regulatory body shall take action materially adversely affecting or questioning the ability of (a) the Insurer to issue or perform under credit facilities in transactions similar to the transaction contemplated by this Bond Purchase Agreement or (b) the Insurer to perform its obligations under any credit facility provided by the Insurer.

SECTION 5. CONDITIONS OF THE BOARD'S OBLIGATIONS.

The Board's obligations hereunder are subject to the Underwriter's performance of its obligations hereunder.

SECTION 6. REPRESENTATIONS AND AGREEMENTS TO SURVIVE DELIVERY.

All of the Board's representations and agreements shall remain operative and in full force and effect, regardless of any investigations made by the Underwriter on its own behalf, and shall survive delivery of the Series 2022 Bonds to the Underwriter.

SECTION 7. PAYMENT OF EXPENSES.

Whether or not the Series 2022 Bonds are sold by the Board to the Underwriter, the Underwriter shall be under no obligation to pay any expenses incident to the performance of the Board's obligations hereunder. All expenses and costs of the Board incident to issuing the Series 2022 Bonds (to the extent not included in the purchase price) including, without limitation, the fees and expenses of Bond Counsel, fees and expenses of counsel to the Trustee and Escrow Trustee, fees and expenses of counsel to the Board, the expenses and costs for the preparation, printing, photocopying, execution and delivery of the Bond Resolution, this Bond Purchase Agreement, the Insurance Policy and all other agreements and documents contemplated hereby, costs for the preparation of the Verification Report, the fees and expenses of consultants and rating agencies, the State Bond Commission fees, the initial fee of the Trustee in connection with the issuance of the Series 2022 Bonds, the expenses and costs for the preparation, printing, photocopying, execution and delivery of the Series 2022 Bonds, the Official Statement, preparation of any Blue Sky law survey or memorandum and/or legal investment survey shall be paid by the Board.

The Underwriter shall pay (i) the cost of preparing and publishing all advertisements relating to the Series 2022 Bonds upon commencement of the offering of the Series 2022 Bonds; (ii) the cost of the transportation and lodging for officials and representatives of the Underwriter to attend meetings and the Closing; (iii) any fees of the Municipal Securities Rulemaking Board in connection with the issuance of the Series 2022 Bonds; (iv) the cost of obtaining a CUSIP number assignment for the Series 2022 Bonds and (iv) all other expenses incurred by them (including fees and expenses of Underwriter's Counsel) in connection with the public offering and the distribution of the Series 2022 Bonds.

SECTION 8. NOTICE.

Any notice or other communication to be given to the Board under this Bond Purchase Agreement may be given by mailing or delivering the same in writing to Board of Supervisors of Louisiana State University and Agricultural and Mechanical College, 3810 West Lakeshore Drive, Baton Rouge, Louisiana 70808, Attention: President, Louisiana State University and to Louisiana State University and Agricultural and Mechanical College, 330 Thomas Boyd Hall, Baton Rouge, Louisiana 70803, Attention: Interim Executive Vice President for Finance and Administration/ CFO; and any notice or other communication to be given to the Underwriter under this Bond Purchase Agreement may be given by mailing or delivering the same to Raymond James & Associates, Inc., Public Finance, 909 Poydras Street, Suite 1300, New Orleans, Louisiana 70112.

SECTION 9. APPLICABLE LAW; NONASSIGNABILITY.

This Bond Purchase Agreement shall be governed by the laws of the State. This Bond Purchase Agreement shall not be assigned by any party. The representations, warranties, covenants and obligations of the Underwriter hereunder, and the terms and conditions of this Bond Purchase Agreement shall be binding on the Underwriter.

SECTION 10. DETERMINATION OF END OF UNDERWRITING PERIOD.

For purposes of this Bond Purchase Agreement, the "*End of the Underwriting Period*" for the Series 2022 Bonds shall mean the earlier of (a) the Closing Date, unless the Board has been notified in writing to the contrary by the Underwriter on or prior to the Closing Date, or (b) the date on which the End of the Underwriting Period for the Series 2022 Bonds has occurred under Rule 15c2-12; provided, however, that the Board shall be entitled to treat as the End of the Underwriting Period for the Series 2022 Bonds the date specified in the notice from the Underwriter stating the date which is the End of the Underwriting Period.

The Board may request from the Underwriter from time to time, and the Underwriter shall provide to the Board upon such request, such information as may be reasonably required in order to determine whether the End of the Underwriting Period for the Series 2022 Bonds has occurred under Rule 15c2-12 with respect to the unsold balances of Series 2022 Bonds that were originally sold to the Underwriter for resale to the public and which are held by the Underwriter for resale to the public.

If, in the opinion of the Underwriter, for purposes of Rule 15c2-12, the Underwriter does not retain for sale to the public any unsold balance of Series 2022 Bonds originally sold to the Underwriter pursuant to this Bond Purchase Agreement, then the Underwriter shall promptly notify the Board in writing that, in its opinion, the End of the Underwriting Period for the Series 2022 Bonds under Rule 15c2-12 has occurred on a date which shall be set forth in such notification.

SECTION 11. ARM-LENGTHS TRANSACTION.

The Board acknowledges and agrees that (i) the purchase and sale of the Series 2022 Bonds pursuant to this Bond Purchase Agreement is an arm's-length commercial transaction between the Board and the Underwriter; (ii) in connection with such transaction, including the process leading thereto, the Underwriter is acting solely as a principal and not as an agent or a fiduciary of the Board; (iii) the Underwriter has neither assumed an advisory or fiduciary responsibility in favor of the Board with respect to the offering of the Series 2022 Bonds or the process leading thereto (whether or not the Underwriter, or any affiliate of the Underwriter, has advised or is currently advising the Board on other matters) nor has it assumed any other obligation to the Board except the obligations expressly set forth in this Bond Purchase Agreement, (iv) the Underwriter has financial and other interests that differ from those of the Board; and (v) the Board has consulted with its own legal and financial advisors to the extent it deemed appropriate in connection with the offering of the Series 2022 Bonds.

SECTION 12. MISCELLANEOUS.

This Bond Purchase Agreement is executed by the Interim Executive Vice President for Finance and Administration/CFO of the University. By the execution hereof, the parties agree that for the payment of any claim or the performance of any obligation hereunder resort shall be had solely to the Auxiliary Revenues of the University and no member, officer or employee of the Board or employee of the University shall be personally liable therefor.

The Underwriter agrees that no member, officer or employee of the Board shall be personally liable for the payment of any claim or the performance of any obligation hereunder.

SECTION 13. EXECUTION OF COUNTERPARTS.

This Bond Purchase Agreement may be executed in several counterparts, each of which shall be regarded as an original and all of which shall constitute one and the same document.

[SIGNATURE PAGES FOLLOW]

[SIGNATURE PAGE TO BOND PURCHASE AGREEMENT]

RAYMOND JAMES & ASSOCIATES, INC.

By: _____
Name: _____
Title: _____

[SIGNATURE PAGE TO BOND PURCHASE AGREEMENT]

BOARD OF SUPERVISORS OF LOUISIANA STATE
UNIVERSITY AND AGRICULTURAL AND
MECHANICAL COLLEGE

By: _____
Name: Donna K. Torres
Title: Interim Executive Vice President for
Finance and Administration/CFO,
Louisiana State University

EXHIBIT A

AMOUNTS, MATURITIES, INTEREST RATES, YIELDS AND PRICES

[TO COME]

EXHIBIT B
RULE 15c2-12
CERTIFICATE OF
BOARD OF SUPERVISORS OF
LOUISIANA STATE UNIVERSITY
AND AGRICULTURAL AND MECHANICAL COLLEGE

[TO COME]



Board of Supervisors

PROPERTY & FACILITIES COMMITTEE

BOARD OF SUPERVISORS MEETING | OCTOBER 28-29, 2021



Board of Supervisors

Request from LSU Health Sciences Center – New Orleans to Approve the Execution of an Amendment to the Master Hospital Lease to Remove the Orange and Brown Parking Areas from the Master Hospital Lease

Date: October 29, 2021

1. Bylaw Citation

This is a significant board matter pursuant to the Board's Bylaws, Art. VII, Sec. 1:

E. Lease of Immovable Property.

The lease of any immovable property, as lessee or lessor, where either:

8. For purposes of these Bylaws, a "lease" shall mean any agreement allowing for the use or occupancy of building space on land on an exclusive basis or a continuous term of six (6) months or more...

2. Summary of Matter

In 2013 the LSU Board of Supervisors entered into a Master Hospital Lease by and among the Board of Supervisors of LSU, University Medical Center Management Corporation, and the State of Louisiana through the Division of Administration for the operation of the newly constructed hospital in New Orleans. That hospital agreement was amended and restated after the original lease was entered into, and it has been amended two more times since that date.

Pursuant to the First Amendment to the Amended and Restated Lease, certain property was added to the hospital lease, including parking areas referred to as the "Orange Lot" and the "Brown Lot." Those Lots are reflected on Attachment "A" (Third Amendment to Amended and Restated Master Hospital Lease). Since that time, UCMCMC has built a parking garage on the leased property and no longer needs use of the Orange and Brown Lots. It is proposed that the LSU Board of Supervisors enter into a Third Amendment to the Amended and Restated Master Hospital Lease to now remove those two Lots from the Master Hospital Lease. The Health Sciences Center-New Orleans will use those parking lots to provide parking for, among other things, new housing that is being constructed for students and others with relationships to the Health Sciences Center-New Orleans.

Finally, once this Amendment is executed to remove the parking lots from the Master Hospital Lease, we will request transfer of the parking lots from LSU Health Care Services Division (HCSD) to LSU Health Sciences Center (LSUHSC-NO), consistent with the MOU between HCSD and LSUHSC-NO, dated January 11, 2016, which transferred LSU properties in the New Orleans Medical District to LSUHSC-NO.

The document presented to the Board for its consideration is the Third Amendment to the Amended and Restated Hospital Lease.

This Resolution will also rescind a prior resolution from the November 2, 2018 Board of Supervisors meeting, a copy of which is attached as Attachment "B" in which a submission

regarding the same property was presented and approved by the Board but not executed due to a change in circumstances. The November 2, 2018 submission states that the execution of the Amendment would occur immediately followed by a separate agreement to grant a right of use of those parking lots back to UMCMC, ending once the LSUHSC-NO student housing was completed. Shortly after this, however, the UMCMC awarded and commenced construction of the new parking garage on the hospital site and which had a completion date well before the LSUHSC-NO requirement for the parking for the new housing. UMCMC and LSUHSC-NO agreed that transfer could wait until the UMCMC parking garage was complete. The parking garage is now complete and was put into service this month.

3. Review of Business Plan

Not applicable.

4. Fiscal Impact

Because no rental increase was applied when the Orange and Brown Lots were added to the Master Hospital Lease by the First Amendment, the rent will not be reduced when the Orange and Brown Lots are excluded from the Master Hospital Lease.

5. Description of Competitive Process

Not applicable.

6. Review of Legal Documents

Appropriate legal documents are attached and have been presented for review by the Office of General Counsel.

7. Parties of Interest

Board of Supervisors of Louisiana State University and Agricultural and Mechanical College; LSU Health Sciences Center-New Orleans, University Medical Center Management Corporation, and State of Louisiana through the Division of Administration.

8. Related Transactions

By separate agreement, a Second Addendum to the MOU between LSU Health Care Services Division (HCS D) and LSU Health Sciences Center (LSUHSC-NO), dated January 11, 2016, will be executed to transfer the Brown and Orange lots from HCS D to LSUHSC-NO.

9. Conflicts of Interest

Not applicable.

10. Attachments

- A. Third Amendment to Amended and Restated Master Hospital Lease
- B. November 2, 2018 Board Submission

RESOLUTION

NOW, THEREFORE, BE IT RESOLVED that the Board of Supervisors of Louisiana State University and Agricultural and Mechanical College does hereby authorize the President of Louisiana State University, or his designee, to execute a Third Amendment to Amended and Restated Master Hospital Lease among the Board of Supervisors of Louisiana State University and Agricultural and Mechanical College, University Medical Center Management Corporation, and State of Louisiana, through the Division of Administration to remove property located in Squares 499 and 518 on the LSU Health Sciences Center Downtown Campus in the First Municipal District of the City of New Orleans, Parish of Orleans, State of Louisiana as reflected in Attachment "A" attached to this request.

BE IT FURTHER RESOLVED that the President of Louisiana State University, or his designee, is authorized to include in said Third Amendment to Amended and Restated Master Hospital Lease such terms and conditions as he deems in the best interest of the Board of Supervisors of Louisiana State University and Agricultural and Mechanical College.

BE IT FURTHER RESOLVED that the Resolution of the Board of Supervisors, dated November 2, 2018 and titled "Request from the LSU Health Sciences Center - New Orleans to Approve the Execution of an Amendment to the Master Hospital Lease to Remove the Orange and Brown Parking Areas from the Master Hospital Lease" (a copy of which is attached as Attachment (B) is hereby rescinded and replaced by this Resolution.

ATTACHMENT A

**THIRD AMENDMENT TO
AMENDED AND RESTATED MASTER HOSPITAL LEASE**

STATE OF LOUISIANA

PARISH OF EAST BATON ROUGE

PARISH OF ORLEANS

This **THIRD AMENDMENT TO AMENDED AND RESTATED MASTER HOSPITAL LEASE** ("**Third Amendment**") is made and entered into on this 1st day of October, 2021, by and among:

BOARD OF SUPERVISORS OF LOUISIANA STATE UNIVERSITY AND AGRICULTURAL AND MECHANICAL COLLEGE, a public constitutional corporation organized and existing under the Constitution and laws of the State of Louisiana, domiciled in the Parish of East Baton Rouge, State of Louisiana, with a mailing address of 3810 West Lakeshore Drive, Baton Rouge, Louisiana, 70808, appearing herein through F. King Alexander, President of Louisiana State University, duly authorized and empowered by LSU, ("**LSU**");

UNIVERSITY MEDICAL CENTER MANAGEMENT CORPORATION, a Louisiana nonprofit corporation, herein through William J. Masterton, CEO, duly authorized and empowered, with a mailing address of 2000 Canal Street, New Orleans, Louisiana, 70112 ("**UMCMC**")

STATE OF LOUISIANA, through the **DIVISION OF ADMINISTRATION**, herein represented and appearing through Jay Dardenne, Commissioner of Administration, Division of Administration, Office of the Governor, State of Louisiana, under the authority granted pursuant to La. R.S. 39:11 and other applicable law, whose mailing address is Post Office Box 94095, Baton Rouge, Louisiana, 70804-9095 ("**State**" or "**DOA**")

as follows:

RECITALS

WHEREAS, the parties have heretofore executed that certain Amended and Restated Master Hospital Lease, having an effective date as of May 29, 2013 ("**Amended and Restated Lease**"), as amended by a First Amendment to Amended and Restated Master Hospital Lease, dated July 29, 2015 ("**First Amendment**"), as amended by a Second Amendment to Amended and Restated Master Hospital Lease, dated April 1, 2016 ("**Second Amendment**"), (and together with the Amended and Restated Lease, the "**Lease**"; any capitalized terms used but not defined herein shall have the meanings ascribed to such terms in the Lease);

WHEREAS, the First Amendment added certain Additional Premises to the Leased Premises, including, without limitation, the real property referred to as the "**Orange Lot**" and the "**Brown Lot**," as more fully described in the First Amendment; and

WHEREAS, the parties hereto now desire to enter into a Third Amendment to amend the Lease to remove the "**Orange Lot**" and the "**Brown Lot**" from the Leased Premises, said Orange Lot and Brown Lot consisting of parking areas more particularly described on Attachments "A" and "B" hereto;

NOW, THEREFORE, in consideration of the mutual covenants contained herein and other good and valuable consideration, the receipt and sufficiency of which are hereby acknowledged, the parties hereto hereby agree to amend the Lease as follows:

1. Construction of Leased Premises. Effective the 1st day of October, 2021, the Orange Lot and the Brown Lot shall be removed from the Leased Premises, and the description of the Additional Premises as set forth on Exhibit "A" to the First Amendment is hereby amended by deleting Section 1 from Exhibit "A."

2. **Terms of Lease.** Except as herein modified or amended, the provisions, conditions and terms of the Lease shall remain unchanged and in full force and effect, as amended by this Third Amendment.

3. **Inconsistencies.** In the event of any conflicts or inconsistencies between the provisions of this Third Amendment and those of the Amended and Restated Master Hospital Lease, as amended by the provisions of the First and Second Amendments, the provisions of this Third Amendment shall control.

4. **Counterparts.** This Third Amendment may be executed in multiple counterparts, each of which shall be deemed an original, but all of which together, shall constitute one agreement.

5. **Intervention.** Now, herein, enters Louisiana Children's Medical center ("LCMC") to individually and *in solido* with UMCMC agree to the terms of this Third Amendment, and it is expressly agreed that the provisions of the Lease, as amended by this Third Amendment, as to the removal of the Orange Lot and the Brown Lot, supersede and control any provisions of the Cooperative Endeavor Agreement ("CEA") or any related agreements to the contrary, if any.

[Remainder of Page Intentionally Blank. Signatory Pages Following.]

*[Signatory Page for the **Board of Supervisors of Louisiana State University and Agricultural and Mechanical College, to the Third Amendment of Amended and Restated Master Hospital Lease.**]*

This Third Amendment to Amended and Restated Master Hospital Lease, by and between the Board of Supervisors of Louisiana State University and Agricultural and Mechanical College, University Medical Center Management Corporation, and the State of Louisiana, through the Division of Administration, is executed in multiple originals.

IN WITNESS WHEREOF, the parties hereto have signed their names on the dates indicated, effective the ____ day of _____, 2021.

WITNESSES:

**BOARD OF SUPERVISORS OF LOUISIANA
STATE UNIVERSITY AND AGRICULTURAL
AND MECHANICAL COLLEGE**

Printed Name: _____

By: _____

William F. Tate, IV, President
Louisiana State University

Printed Name: _____

Date Executed: _____

[Signatory Page University Medical Center Management Corporation and the State of Louisiana through the Division of Administration of the Third Amendment of Amended and Restated Master Hospital Lease.]

This Third Amendment to Amended and Restated Master Hospital Lease, by and between the Board of Supervisors of Louisiana State University and Agricultural and Mechanical College, University Medical Center Management Corporation, and the State of Louisiana, through the Division of Administration, is executed in multiple originals.

IN WITNESS WHEREOF, the parties hereto have signed their names on the dates indicated, effective the ____ day of _____, 2021.

WITNESSES:

**UNIVERSITY MEDICAL CENTER
MANAGEMENT CORPORATION**

Printed Name: _____

Printed Name: _____

By: _____

Christine Bond
Chief Financial Officer

Date Executed: _____

WITNESSES:

**STATE OF LOUISIANA, through the
DIVISION OF ADMINISTRATION**

Printed Name: _____

Printed Name: _____

By: _____

Jay Dardenne
Commissioner of Administration

Date Executed: _____

*[Signatory Page for the Intervenor/Guarantor, Louisiana Children's Medical Center,
to the Third Amendment of Amended and Restated Master Hospital Lease.]*

This Third Amendment to Amended and Restated Master Hospital Lease, by and between the Board of Supervisors of Louisiana State University and Agricultural and Mechanical College, University Medical Center Management Corporation, and the State of Louisiana, through the Division of Administration, is executed in multiple originals.

IN WITNESS WHEREOF, the parties hereto have signed their names on the dates indicated, effective the _____ day of _____, 2021.

WITNESSES:

Printed Name: _____

Printed Name: _____

INTERVENOR/GUARANTOR:

LOUISIANA CHILDREN'S MEDICAL CENTER

By: _____

Gregory C. Feirn, President
and Chief Executive Officer

Date Executed: _____

ATTACHMENT A

LOCATION OF TWO PARKING LOTS

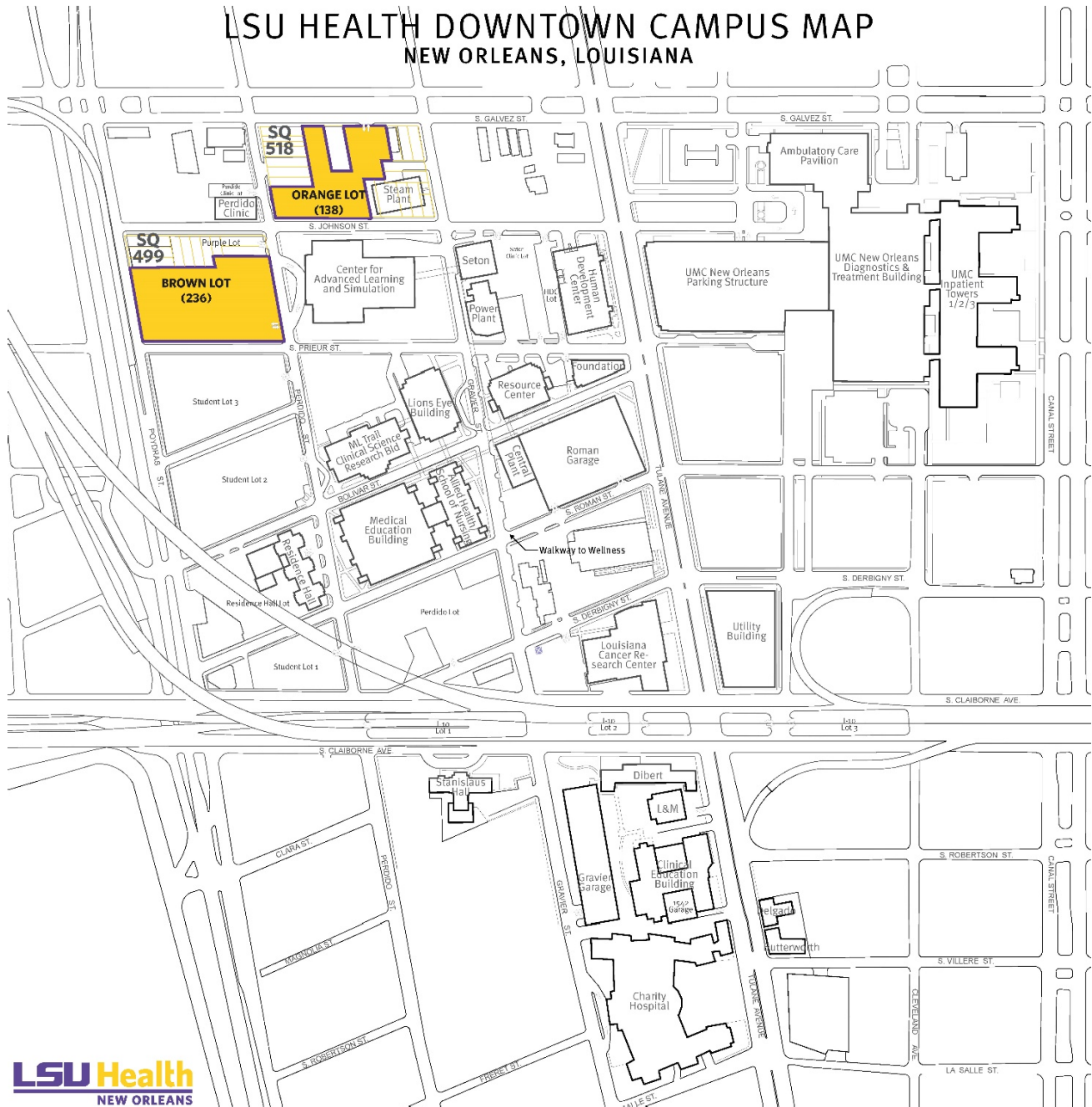

FIGURE 1. The Brown and Orange Parking Lots shown on the LSU Health New Orleans Downtown Campus Map.

The Brown and Orange Parking Lots are located on Squares 499 & 518 on the LSU Health Sciences Center Downtown Campus in the First Municipal District of the City of New Orleans, Parish of Orleans, State of Louisiana.

ATTACHMENT B

LEGAL DESCRIPTION OF TWO PARKING LOTS

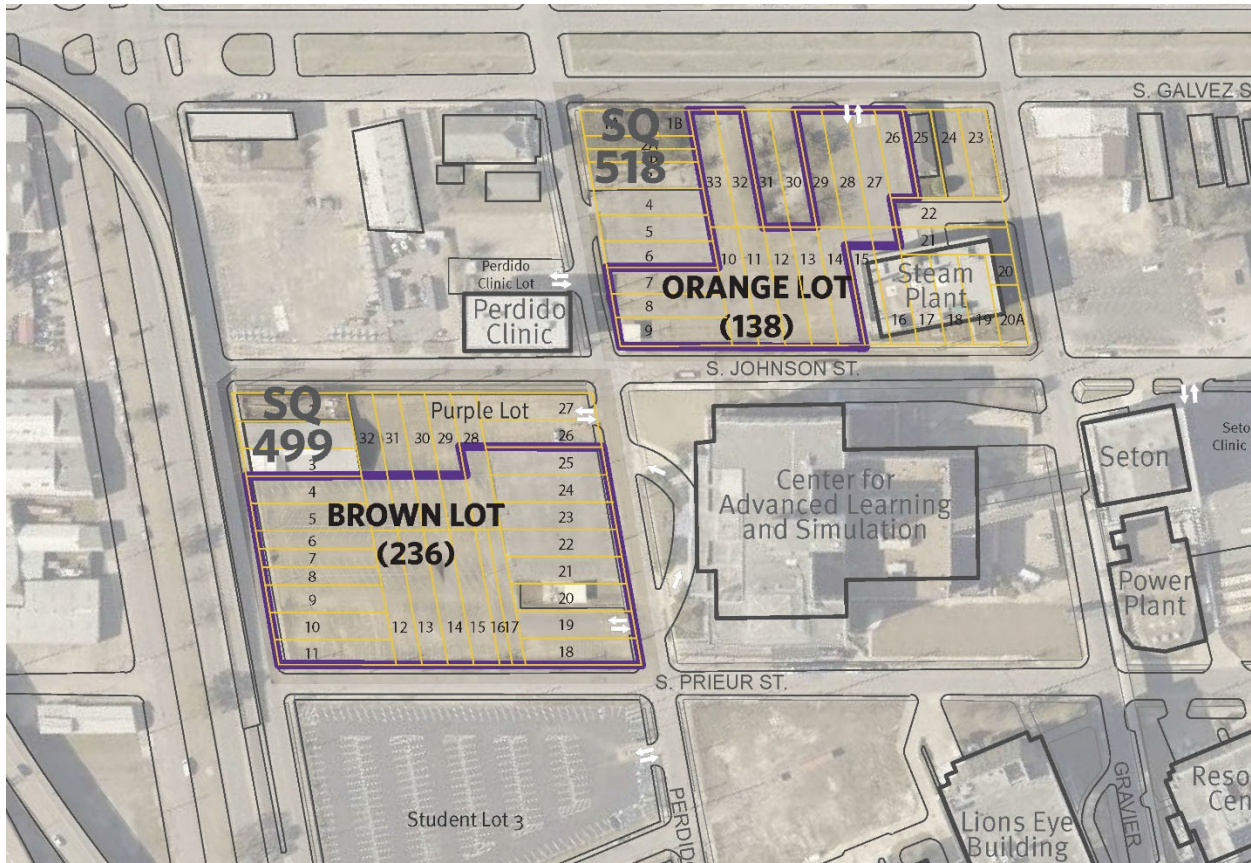

FIGURE 2. Squares 499 & 518 with the Brown and Orange Parking Lots.

The Brown Parking Lot consists of 236 parking spaces in Square 499 in the First Municipal District of the City of New Orleans, Parish of Orleans, State of Louisiana. In SQ 499, the parking lot is the entire parcel for parcels 4 through 25, 90.75' of parcel 28, and 60.5' of parcels 29 through 32 each. The area of the Brown Parking Lot is 87,197 square feet or 2.0 acres. The Orange Parking Lot consists of 138 parking spaces in Square 518 in the First Municipal District of the City of New Orleans, Parish of Orleans, State of Louisiana. In SQ 518, the parking lot is the entire parcel for parcels 7-14, 26-29, and 32-33; additionally, 16' of parcels 27 and 28. The area of the Orange Parking Lot is 53,499 square feet or 1.2 acres.

ATTACHMENT B



Request from LSU Health Sciences Center – New Orleans to Approve the Execution of an Amendment to the Master Hospital Lease to Remove the Orange and Brown Parking Areas from the Master Hospital Lease

To: Members of the Board of Supervisors

Date: November 2, 2018

This is a significant board matter pursuant to the Board's Bylaws, Art. VII, Sec. 1:

C. Lease of Immovable Property.

1. Summary of the Matter

In 2013 the LSU Board of Supervisors entered into a Master Hospital Lease by and among the Board of Supervisors of LSU, University Medical Center Management Corporation, and the State of Louisiana through the Division of Administration for the operation of the newly constructed hospital in New Orleans. That hospital agreement was amended and restated after the original lease was entered into, and it has been amended two more times since that date.

Pursuant to the First Amendment to the Amended and Restated Lease, certain property was added to the hospital lease, including parking areas referred to as the "Orange Lot" and the "Brown Lot." Those Lots are reflected on Exhibit "A" to this request. It is proposed that the LSU Board of Supervisors enter into a Third Amendment to the Amended and Restated Master Hospital Lease to now remove those two Lots from the Master Hospital Lease. The Health Sciences Center-New Orleans needs to take back the use of those parking lots to provide parking for, among other things, new housing that will be constructed on adjacent private property for students and others with relationships to the Health Sciences Center-New Orleans. In addition, because the University Medical Center Management Corporation, Lessee under the Master Hospital Lease, has a short-term need for those parking lots, LSUHSC-New Orleans by separate agreement will grant a right of use of a portion of those parking lots to UMCMC for a period not to exceed the lesser of four and one-half years (4 1/2) years or the completion of the nearby housing.

Finally, once this Amendment is executed to remove the parking lots from the Master Hospital Lease, we will request transfer of the parking lots from LSU Health Care Services Division (HCSD) to LSU Health Sciences Center (LSUHSC-NO), consistent with the MOU between HCSD and LSUHSC-NO, dated January 11, 2016, which transferred LSU properties in the New Orleans Medical District to LSUHSC-NO.

The document presented to the Board for its consideration is the Third Amendment to the Amended and Restated Hospital Lease.

2. Review of Business Plan

Not applicable.

3. Fiscal Impact

Because no rental increase was applied when the Orange and Brown Lots were added to the Master Hospital Lease by the First Amendment, the rent will not be reduced when the Orange and Brown Lots are excluded from the Master Hospital Lease. UMCMC's agreement to release the parking lots, referred to as the "Brown" and "Orange" lots in the Master Hospital Lease by this Amendment, subject to UMCMC's continuing right of use until completion of nearby student housing, will also be partially offset by the provision of LSUHSC parking to the UMCMC elsewhere on Campus. These spaces will be rented, possibly at a reduced rate, as consideration for the UMCMC early release of the Orange and Brown lots from the Master Hospital Lease.

4. Description of Competitive Process

Not Applicable.

5. Review of Legal Documents

Appropriate legal documents are attached and have been presented for review by the Office of General Counsel.

6. Parties of Interest

Board of Supervisors of Louisiana State University and Agricultural and Mechanical College; LSU Health Sciences Center-New Orleans, University Medical Center Management Corporation, and State of Louisiana through the Division of Administration.

7. Related Transactions

By separate agreement, LSUHSC-NO will grant a short-term right of use over a portion of the Orange and Brown Lots to UCMC for a term not to exceed the lesser of four and one-half (4 ½) years or the completion of the nearby private residential housing.

By separate agreement, a Second Addendum to the MOU between LSU Health Care Services Division (HCSO) and LSU Health Sciences Center (LSUHSC-NO), dated January 11, 2016, will be executed to transfer the Brown and Orange lots from HCSO to LSUHSC-NO.

8. Conflicts of Interest

Not applicable.

ATTACHMENTS

- I. Plat showing location of Orange and Brown Lots;
- II. Third Amendment to Amended and Restated Master Hospital Lease.

RESOLUTION

NOW, THEREFORE, BE IT RESOLVED that the Board of Supervisors of Louisiana State University and Agricultural and Mechanical College does hereby authorize F. King Alexander, President of Louisiana State University, or his designee, to execute a Third Amendment to Amended and Restated Master Hospital Lease among the Board of Supervisors of Louisiana State University and Agricultural and Mechanical College, University Medical Center Management Corporation, and State of Louisiana, through the Division of Administration for property located in Squares 499 and 518 on the LSU Health Sciences Center Downtown Campus in the First Municipal District of the City of New Orleans, Parish of Orleans, State of Louisiana

BE IT FURTHER RESOLVED that F. King Alexander, President of Louisiana State University, or his designee, is authorized to include in said Third Amendment to Amended and Restated Master Hospital Lease such terms and conditions as he deems in the best interest of the Board of Supervisors of Louisiana State University and Agricultural and Mechanical College.



Board of Supervisors

Request from LSU A&M to amend the 2022-2023 Five-Year Capital Outlay Budget Request and First Year Prioritized List for Louisiana State University

Date: October 28-29, 2021

1. Bylaw Citation

Pursuant to Article VII, Section 2, A and B of the Bylaws of the Louisiana State University Board of Supervisors, this matter is a “significant board matter”.

- A. Board approval of any capital outlay request or item, or approval of an operating budget, shall not be considered direct or indirect approval of any program or action, or authority to anyone to proceed in undertaking such matter, unless such matter relating to an approved capital outlay is separately and expressly approved by the Board after full compliance, review, and specific approval by the Board or President.
- B. Capital outlay prioritization must be approved by the Board or by the Executive Committee.

2. Summary of Matter

At the September 10, 2021 meeting, the Board of Supervisors approved the FY 2022-2023 Capital Outlay Budget Request for Louisiana State University in accordance with state law and established procedures.

LSU A&M requests the “**Military and Security Sciences Building**” project be included in the FY 2022-2023 Capital Outlay Budget Request. State funds will be requested to cover the approximate total project cost of approximately \$61,000,000.

3. Review of Business Plan

Not applicable

4. Fiscal Impact

Not applicable

5. Description of Competitive Process

Not applicable

6. Review of Legal Documents

Not applicable

7. Parties of Interest

Not applicable

8. Related Transactions

Not applicable

9. Conflicts of Interest

Not applicable

10. Attachments

None

RESOLUTION

NOW, THEREFORE, BE IT RESOLVED by the Board of Supervisors of Louisiana State University and Agricultural and Mechanical College that the FY 2022-2023 Five-Year Capital Outlay Budget Request and First Year Prioritized Categories for Louisiana State University be amended to include the project listed below:

LSU A&M

Project Title: Military and Security Sciences Building

Total Project Cost: \$61,000,000 State Funds



Board of Supervisors

Request from LSU A&M to authorize a Cooperative Endeavor Agreement and Lease for the Utilities Modernization Initiative

Date: October 29, 2021

1. Bylaw Citation

This is a Significant Board Matter pursuant to Article VII, Section 1 of the Board's Bylaws:

- E.1 The lease of any immovable property for a term of 5 years or more
- G.1 Capital improvements over \$1 million
- J.2 Cooperative Endeavor Agreements
- J.3 Contracts raising significant financial or other policy issues, such as a privatization of a major university function

2. Summary of Matter

Background

LSU's utilities infrastructure is essential to the long-term success of the University and consists of three elements - the utility plant system, the distribution system, and the building mechanical systems. Working together, these three elements are responsible for providing heating, cooling, and electricity to the campus.

Each of these three elements is aging, and like much of the campus, suffering from extensive deferred maintenance due to a lack of capital funding. The current utilities infrastructure fails to provide redundancy for the campus, meaning that even a small failure in one component of the system can cause large portions of campus to suffer a loss of heating and cooling. The utilities infrastructure requires investment to reliably meet the campus' current needs and to be prepared for future needs based on anticipated growth described in the Comprehensive and Strategic Campus Master Plan.

Thanks to the hard work of LSU facilities staff, many of the major components of the utilities infrastructure have continued to operate long after the end of their expected useful life, but this is not a sustainable strategy. Major components of the utilities infrastructure are beginning to fail, resulting in large, unplanned expenses for emergency repairs and replacements in order to maintain uninterrupted heating and cooling services on campus which divert resources from other campus priorities.

As an illustrative example, LSU currently has approximately 3-5% surplus capacity to cool the campus during the summer and early fall. If a single turbine or pump fails, some buildings will be uncomfortably warm. For example, at the beginning of the Spring 2018 semester, a cooling tower suffered catastrophic failure, and LSU was forced to spend approximately \$4.5 million to replace the tower and to rent emergency equipment to keep the campus properly cooled. This type of reactive maintenance is expensive and does not allow LSU to strategically invest in a more modern and efficient system.

Utilities Modernization Initiative

Working with its consultants, LSU prepared the Utilities Modernization Initiative (“UMI”), which called for a public-private partnership with an energy services firm to finance, construct, and operate significant renovations to LSU’s utility plant system (the Central Utility Plant and the Highland Utility Plant) and portions of its distribution system. The UMI also provides for the same private firm to operate the improved plants for the term of the agreement, as well as for the potential future construction of improvements to the various building mechanical systems.

After substantial analysis, evaluation, and negotiations, which are described in the “project history” section below, LSU has negotiated the following proposed deal terms with two private firms and the LSU Real Estate and Facilities Foundation (“REFF”). The proposed set of agreements is consistent with, and stem from, the Board’s direction at its February 2021 meeting.

LSU is expected to save money through implementation of the Utilities Modernization Initiative through the proposed agreement in two ways. First, the vendor will charge LSU less for the operations and maintenance of the utility plant system than the costs LSU incurs performing the same services itself. Second, the capital improvements to be made by the vendor will result in greater energy efficiencies in the production of steam and chilled water to heat and cool the campus, reducing the amount of commodities (electricity and natural gas) consumed by LSU.

The UMI will be implemented through three agreements: a Cooperative Endeavor Agreement, a Prime Lease, and a Sublease and Concession Agreement.

Cooperative Endeavor Agreement

The proposed Cooperative Endeavor Agreement (“CEA”) sets forth the overall arrangement. It is not intended to contain detailed business terms, but to set forth the overall arrangement between the parties. The parties are:

1. LSU
2. Utilities Modernization, LLC (“UMLLC,” a special purpose entity formed by REFF)
3. CenTrio (formerly known as Enwave)
4. Tiger Energy Partners, LLC (“TEP,” a joint venture of Bernhard, LLC and Johnson Controls)

Under the structure set forth in the CEA, LSU will:

- Lease its utility plant system and related facilities to UMLLC, requiring UMLLC to enter into the Concession Agreement with CenTrio under terms provided by LSU
- Make appropriate payments, through UMLLC, to CenTrio in return for the operating and maintenance services it will provide over the 30 year term, including an amount sufficient to cover the debt service owed by CenTrio used to pay for the IMP construction

Under the structure set forth in the CEA, UMLLC will:

- Lease LSU’s utility plant system and related facilities from LSU, and sublease those same facilities to CenTrio, under terms prescribed by LSU and CenTrio
- As set forth in the Sublease and Concession Agreement, the **only** payment that UMLLC or REFF will receive through any of these agreements will be an annual charge of \$7,500

to cover its costs associated with accounting, record-keeping, and tax filing functions it must perform to fulfill its role

Under the structure set forth in the CEA, CenTrio will:

- Sublease LSU's utility plant system and certain related facilities for a term of 30 years
- Cause TEP to design and construct the Initial Modernization Project ("IMP")
- Operate the utility plant system and related facilities during the term of the lease
- Have a right to propose future improvements to the utility plant system and the distribution system, which CenTrio will finance, maintain, and operate and which TEP will design and construct

Under the structure set forth in the CEA, TEP will:

- Design and construct the IMP and any future utility plant system or distribution system improvements, under contract to CenTrio
- Have a right to propose future improvements to LSU building mechanical systems, which TEP will finance, design, and construct with no involvement from CenTrio

In no event is LSU required to conduct any future projects with either CenTrio or TEP. All such projects would be undertaken only if, at the time the project is proposed, LSU, in its sole discretion, determined that doing so will be in its best interests.

Prime Lease

The Long Term Lease and Concession Agreement ("Prime Lease") is between LSU and UMLLC, the REFF subsidiary. The Prime Lease provides for the leasing of LSU's utility plant system and certain related facilities to UMLLC and:

- Requires UMLLC to enter into the Sublease and Concession Agreement with CenTrio
- Requires UMLLC to require CenTrio to perform the obligations that the Sublease and Concession Agreement obligate CenTrio to perform
- Obligates LSU to pay and perform all financial and other obligations owed by UMLLC to CenTrio pursuant to the Sublease and Concession Agreement
- Requires that UMLLC obtain LSU's consent prior to giving any consents to CenTrio called for in the Sublease and Concession Agreement.

Sublease and Concession Agreement

The Long Term Sub-Lease and Concession Agreement for Louisiana State University Utility System contains the definitive terms under which CenTrio will lease, improve, finance, and operate LSU's utility plant system, and under which CenTrio will cause TEP to design and construct the IMP. Key business terms contained in this Agreement are described in section 3, below.

3. Review of Business Plan

Lease

LSU will lease its Central Utility Plant and its Highland Utility Plant (collectively, the “utility plant system”), along with a limited portion of the LSU distribution system and the Vet Med Plant, to UMLLC, which in turn will sublease the same facilities to CenTrio. The primary terms of the Lease are:

- Term of 30 years
- Effective upon financial close
- Financial and other terms discussed below

Annual Financial Terms

LSU will pay an annual Utility Fee to CenTrio in return for the construction improvements and services it is providing. The Utility Fee consists of 3 components:

- Capped O&M Charge of **\$3,360,851.18**
 - This compensates CenTrio for operating and maintaining the utility plant system
 - This was the amount bid by CenTrio in its Best and Final Offer in November 2020
 - It will escalate by 2% annually for inflation
- Capital Charge projected at **\$7,540,997.63** for the first year after substantial completion of the IMP
 - This compensates CenTrio for a notional cost of equity, cost of debt, and amortization to repay the financing used to construct the Initial Modernization Project, calculated as described in the “Financing” section below, and will ultimately include any future capital improvement projects approved by LSU and financed by CenTrio.
 - The amount will increase slightly each year, as the equity return for CenTrio’s 10% of equity in the deal will increase annually by the 2% inflation amount, such that by the end of the 30 year term, the Capital Charge would be approximately \$8.3 million. The amount owed for the debt service, which covers 90% of the amount financed, will be flat, not adjusted for inflation.
 - The actual amount of the Capital Charge will be determined shortly before financial close, based on the Final GMP and the actual interest rate obtained for the IMP
- Uncapped O&M Charge
 - This compensates CenTrio for certain operations and maintenance costs it incurs as a result of changes caused or requested by LSU, or certain changes that cannot be reasonably anticipated or controlled by CenTrio, such as certain changes in law.
 - For example, if LSU needs new capacity in the utility plant system to accommodate campus growth, and thus adds new equipment (either through CenTrio or through a capital outlay process), CenTrio and LSU would negotiate an additional amount to cover CenTrio’s added costs for operating that new equipment.

Initial Modernization Project

LSU’s utility plant system produces electricity, steam, and chilled water which are distributed across campus to heat, cool, and power LSU’s buildings. Under the IMP, TEP, under its contract with CenTrio, will replace or renovate virtually all mechanical equipment (pumps, chillers, boilers, and cooling towers) in the Central Plant and add new equipment in the Highland Plant

to substantially increase its production capacity. In addition, the IMP will improve LSU's electrical substation and remove some bottlenecks which currently exist in the LSU utilities distribution system.

The exact scope of work for the IMP has been carefully prepared by CenTrio and TEP, with close review and approval by LSU and its consultants. The design has been advanced to what is known as the "30% design" stage, which means that the plans are sufficiently complete to allow for reasonable estimation of costs and final determination of design options. Plans at this stage are not sufficient to get final pricing but will be completed prior to financial close in order to determine the Final Guaranteed Maximum Price.

Based on the 30% design documents and the proposed Sublease and Concession Agreement, the IMP will:

- Cost no more than **\$111,880,557**, (the "Initial Guaranteed Maximum Price" or "IGMP"; this figure does not include certain CenTrio costs of financing and reimbursements to LSU that are described under "Financing," below)
 - This IGMP will be replaced with a Final Guaranteed Maximum Price (FGMP), mutually agreed by all parties, prior to financial close of the transaction.
 - CenTrio and TEP have guaranteed that the FGMP will not exceed the IGMP, and the FGMP is expected to be lower than the IGMP.
 - The FGMP will be reported to the Board prior to financial close.
- A summary of the final scope of work is available in Attachment 3 of this submission. Generally, the scope consists of replacing or renovating pumps, chillers, cooling towers, and boilers which actually perform the heating and cooling of water into chilled water or steam, along with related improvements to the electrical system which provides electricity to those machines, and also to underground piping and related gear which distribute the steam and chilled water across campus.
- Comply with LSU's Diverse Supplier Initiative and actively seek to involve DBE firms with the financing, construction, and operation and maintenance of the project, as set forth in Schedule 17 to the Sublease and Concession Agreement
- Provide transparency into the actual construction costs incurred for the project, including review by LSU and its contract monitor of all draw requests submitted by TEP to CenTrio, prior to payment by CenTrio
- If the project is completed below the budgeted amount, LSU, CenTrio, and TEP will share in the savings
 - The basic split is 55% of savings to LSU, with 45% of savings to CenTrio, which it will share with TEP, unless the IMP is completed at least 90 days ahead of schedule, in which case the split of savings would be 45% in favor of LSU and 55% in favor of CenTrio, to provide an incentive for early completion, which would be to LSU's benefit.
 - The IGMP amount includes a \$5 million contingency amount; this amount will be under LSU's control and will NOT be subject to the savings split.

Under the proposed Sublease and Concession Agreement, and based on the 30% design, CenTrio and TEP have proposed that the IMP capital cost will not exceed \$111,880,557 and may be reduced further (but not increased) prior to financial close of the transaction. Details of the final scope agreed to by the parties are summarized in Attachment 3 to this Board submission.

Note that the cost has increased from the \$90 million figure that was used in the competitive negotiation process between CenTrio and TEP for several reasons:

- The \$90 million was always intended to be a rough estimate to allow for an appropriate comparison of the underlying financial and other terms proposed by the two parties.
- The figure was always expected to change upon completion of a full scope of work and design exercise to identify LSU's needs and opportunities more fully.
- During the programming and design exercises with CenTrio and TEP, several bottlenecks in the existing LSU distribution and electrical systems were identified that would prevent portions of the campus from receiving full benefit from the increased plant capacity, or would reduce available redundancies to insure full system performance even when a component is unavailable for a period of time, unless those bottlenecks are eliminated as part of the IMP.
- Construction costs increased substantially due to pandemic-related shortages of material and labor.

As shown in more detail in the Fiscal Impact section below, LSU will still realize substantial savings in commodity costs and reduced O&M costs, despite the increase in capital cost. Further, the scope of work has increased to include the distribution work described, which means that LSU is getting more improvements than originally contemplated.

Financing

The Capital Charge included in calculating the total Utility Fee paid by LSU to CenTrio will be based on the following terms:

- Total Amount Financed, which will be the sum of:
 - Final GMP amount (which will not exceed the IGMP of \$111,880,557).
 - No more than 2.5% of the FGMP for LSU's reimbursable expenses (legal fees, contract monitoring, etc.; LSU does not expect to include this full amount in the financing, but is still calculating the precise costs)
 - No more than \$840,000 of CenTrio's costs of issuance and legal fees associated with the transaction
- Stipulated Debt financing of 90% of the Total Amount Financed
 - 3.3% is the projected interest rate, which will be set shortly before financial close
 - Debt, issued as long-term capital placed through Bank of America
 - One or more DBE financial institutions will be invited to subscribe to the private placement bonds on the same terms as other participating lenders
- Stipulated Equity financing of 10% of the Total Amount Financed
 - 10% after-tax equity return on investment, in accordance with CenTrio's BAFO
 - CenTrio will offer some portion of the equity share to DBE investment groups or entities after completion of construction; however, CenTrio notes that, given the small amount of equity available and the relatively high transaction costs for due diligence to buy-in to the deal, it is unlikely that any investors outside of CenTrio will find it feasible to buy in to the equity return.

Future Projects

LSU has certain rights, but not obligations, to ask (or, in some cases, require) CenTrio to perform improvements to the utility plant system and the distribution system. Such projects would be subject to these terms:

- CenTrio will propose 5-year plans for improvements that would enhance the performance of LSU's utility plant systems or distribution systems, by improving energy efficiencies, reducing operating costs, increasing redundancies, or providing better service to the campus
 - LSU will participate in the planning process
 - LSU is not obligated to accept or act on any of the plans
- Exact scope and design of any projects will be negotiated at the time of the project
- Debt/equity gearing ratio will be negotiated at the time of the project
- Equity return will remain 10% after-tax
- Interest rate for the debt portion of the financing will be set at the time of the project, with a targeted and expected interest rate tied to a Bloomberg-Barclays US-based utilities and energy index
- Any increases in O&M costs caused by the new improvements will be negotiated
- As with the IMP, LSU will have transparency into the actual construction costs incurred, including review by LSU and its contract monitor of all draw requests submitted by TEP to CenTrio, prior to payment by CenTrio
- CenTrio and TEP will continue to conform with LSU's Diverse Supplier Initiative and the goals and objectives set forth in Schedule 17 of the Sublease and Concession Agreement
 - Any DBE firms who participate in the post-construction equity component of the IMP financing will have an opportunity to participate in the equity component of future projects. Again, CenTrio notes that, given the small amount of equity available and the relatively high transaction costs for due diligence to buy-in to the deal, it is unlikely that any DBE investors, or any investors outside of CenTrio, will find it feasible to buy in to the equity return, though this may change depending on the debt/equity gearing ratio agreed for such future projects and the size of such projects
 - DBE financial institutions who participate in the debt portion of the IMP financing will have an opportunity to do so again in the debt component of future projects.

LSU may use capital outlay funds without restriction to construct improvements or add capacity in the utility plant system or the distribution system. For capital outlay projects in the utility plant system that are funded primarily with capital outlay, CenTrio is required to participate in the state design and construction process as LSU's owner's rep, and will receive a fee of 2.5% of certain project costs for doing so. CenTrio will not receive any such fee for projects that it is primarily responsible for financing and constructing.

Plant Performance

CenTrio's operation of the utility plant system will be subject to certain Key Performance Indicators and other performance measures to ensure LSU is receiving the expected services and helps to ensure that the commodity savings are achieved. These KPIs are key to ensuring that

LSU will reduce its consumption of electricity and natural gas and achieve the projected savings from commodities costs.

- The specific KPIs and performance measures to be met were established primarily in the Request for Negotiated Offers issued by LSU and the BAFO submitted by CenTrio. Some of these are technical KPIs intended to ensure that the energy savings goals of the university are met, while others are up-time requirements to ensure that the core requirements to keep the campus lit, heated, and cooled appropriately are met.
- Each KPI and performance measure has a financial consequence attached, a liquidated damages amount for failing to meet the requirements.
- The amount of the liquidated damages is calculated to ensure that, if the energy savings goals are not met (and thus LSU does not receive the benefit from projected savings in commodity purchase), the liquidated damages amount will be sufficient to make LSU whole from that loss

If there are substantial and continued failures to meet the KPIs and performance measures, the amount of liquidated damages owed by CenTrio could become so large as to jeopardize repayment of the debt for the IMP and CenTrio's ability to continue to fund operations of the plants. To protect against this risk (which would be very detrimental to LSU and increase the cost to finance the IMP by increasing risk to the lenders), the agreement contains cap on the amount of liquidated damages which may be paid by CenTrio to LSU in any given year. If the cap applies in a given year, then any amount owed by CenTrio above that cap will roll over to the following year. This roll-over is also subject to cap. To protect LSU from prolonged failure to meet the KPIs, LSU has the right to require CenTrio to replace the plant operator under certain conditions.

- Annual cap on liquidated damages is \$2.5 million
- Liquidated damages in excess of the \$2.5 million in any year will roll over to the following year, for up to 2 years
- If CenTrio owes penalty payments in excess of \$2.5 million in any 2 years within a single 5-year period, LSU has the right to require CenTrio to obtain a new operator for the utility plant system

Employees

LSU and CenTrio both highly value the current utility plant employees, who have an unparalleled knowledge of the plant systems and who have been dedicated to keeping the plants functioning despite the extreme amount of deferred maintenance within them. Under the agreements, LSU employees currently assigned to the utility plant system will be given the option to quit or retire (if eligible) from LSU and be hired by CenTrio, which is committed to retain such employees for at least one year.

Depending on what is allowed by the state Civil Service Commission, LSU intends to allow employees who are within a few years of being eligible for retirement to remain as LSU employees, while LSU leases their services to CenTrio, which will pay LSU the full costs incurred by LSU for such continued employment. It would not be fair to force employees who are only a year or two from retirement to leave LSU and lose their long-expected retirement benefits.

Employees who are not near a major retirement milestone will either have to leave and accept employment with CenTrio, be reassigned to another job at LSU (if any are available) or be laid off. The precise thresholds for which employees will have the option to stay on with LSU while their services are leased to CenTrio will be determined through consultations with the employees and negotiations with the state Civil Service Commission, which will have the final determination of the rules to be followed. If all employees come to a voluntary agreement with CenTrio and LSU, without the need for any layoffs, then no Civil Service Commission action will be required.

Termination

In order to comply with state law requirements governing state debt, the payments owed to CenTrio will be subject to a non-appropriation clause, meaning that if the LSU budget set by the legislature is insufficient, in LSU's judgment, to fund the payments owed to CenTrio, LSU would not have to pay that amount.

However, consistent with state precedent transactions such as the Shaw Center arrangement between TEP's parent entity and the state, if such a non-appropriation event occurs, or if LSU chooses to terminate the agreement for any reason other than the fault of CenTrio, LSU will be required to make a substantial payment to CenTrio upon such termination.

- The compensation on termination amount will be the greater of (a) certain debt of CenTrio and (b) the assessed fair market value of the remaining concession period
 - In LSU's deal with CenTrio, the calculation of fair market value expressly bars the appraiser from assigning any value to hypothetical future projects that were never approved by LSU. This feature favorably distinguishes this project from a number of other lease-based transactions involving university utilities that have closed in recent years.
- If the contract must be terminated as a result of default by CenTrio, the following would apply:
 - LSU, since it will be the owner of the plant improvements, will also have to: (1) repay the principal amount due on the outstanding debt and (2) return the principal amount of the equity, but will not pay any further return on the equity that CenTrio would have earned over the life of the agreement
 - Acts of default by CenTrio include:
 - Failing to comply with any material obligations of the agreement, other than KPIs and Performance Standards
 - Filing for bankruptcy or otherwise becoming insolvent
 - Abandoning the project
 - Failing to complete the IMP by May 30, 2025
 - Note that failure to meet the KPIs and Performance Standards, even for an extended period, will not constitute a default of the agreement, but will allow LSU to require CenTrio to replace the operator of the utility plant system

Risks

No transaction of this magnitude is implemented without risk. One of the prime purposes of entering into these agreements is to shift some risks that LSU already has to the private parties

involved, which the private parties agree to accept in return for payment of the amounts to be paid by LSU. Risks in such transactions can include, but are not limited to:

- Certain construction risk, the risk that construction of the IMP is not achieved on schedule or to the original budget
 - This risk will be shared by CenTrio and TEP
 - If there is a failure during the construction process, LSU is financially protected through the requirement of a substantial performance bond, as is typical with large construction contracts
 - LSU is protected from cost overruns by the Guaranteed Maximum Price set in the agreements.
 - LSU is not obligated to begin payment for the Financial Charge associated with construction of the IMP until the IMP improvements are completed and accepted by LSU.
 - Another construction-related risk is associated with the separate state capital outlay project to fund distribution system improvements related to the new Life Sciences building (the new Science Zone Infrastructure project). To maximize use of state funding, the IMP design assumes that the state project will, as planned, install underground distribution piping that will complete the connection between the Central and the Highland Utility Plants, allowing either or both plants to provide steam and chilled water to most of the existing campus distribution loops. If for any reason the state does not fulfill its commitment to fund and approve the new Science Zone Infrastructure project, the current IMP scope would be insufficient to complete the goals of the IMP. To protect against this risk, LSU needs to make every effort to ensure that the state fully understands the importance of the New Science Zone project and follows through on its commitment. If the state fails to do so, LSU, CenTrio, and TEP will have to make significant changes to the IMP design scope in order to make funds available to complete the anticipated piping.
- Certain operation risk, the risk that the plant is operated inefficiently or incompetently
 - LSU is protected from this risk by the liquidated damages owed by CenTrio if it misses the KPIs or performance measures as well as by LSU's right to require to provide a new operator for the plants, if there are repeated substantial failures to meet those KPIs and performance measures over a period of multiple years
- Commodity price risk
 - Under the agreements, LSU will continue to be responsible for directly contracting with Entergy and a wholesale natural gas supplier for the purchase of electricity and natural gas consumed by the plants.
 - All savings that are guaranteed by the KPI and Performance Standard liquidated damages faced by CenTrio relate to savings of consumption of the relevant commodities, not to savings of a particular dollar amount. This means that if commodity prices go up, LSU could pay more for the electricity and natural gas it consumes than LSU is currently paying. The guarantees simply ensure that LSU won't consume more of those commodities than it is currently consuming.
 - This leaves LSU at risk for:
 - Fluctuations in the price of those commodities
 - Price shifts which would alter the price of electricity and natural gas relative to each other, which could affect the dollar value of savings

recognized by the university over time as a result of the design choices made for the IMP.

Balanced against these risks are the risks of inaction. These risks include, but are not limited to:

- Continued degradation of the LSU utility systems, with major components failing at unpredictable times. Emergency, piece-meal replacements made necessary by such failures would certainly cost more and be less energy efficient than the complete overhaul of the utility plant systems and related facilities in accordance with this process.
- Failure to operate the plant optimally. While LSU has exceptional employees who have done an excellent job keeping the aging equipment of the utility plant system functioning, LSU also has difficulty attracting and retaining highly qualified plant operators, due to competition from the chemical and petroleum plants in the area
- Higher commodity consumption caused by the continued use of old, outdated equipment within the utility plant system

Benefits

LSU expects to receive substantial benefits from entering into the proposed transaction, which will exceed in value the risks described above. LSU will receive:

- Substantial savings, more fully set forth in the “Fiscal Impact” section below, including
 - Energy efficiencies leading to a reduced consumption of commodities such as electricity, natural gas, and water
 - Reduced costs for operating and maintaining the utility plant system
- Elimination of over \$100 million in deferred maintenance associated with the aging equipment in the plants
- Improved redundancies throughout the utilities infrastructure, increasing the reliability of the system
- Substantial reduction of risk of catastrophic failure of the current, aging components of the utility plant system, thereby reducing the risk that the campus would face prolonged utility outages as well as the risk that LSU would be forced to incur extreme costs for emergency equipment rentals and emergency replacements of failed components.

Schedule and Approvals

Prior to execution, the proposed transactions must receive approval from:

1. Louisiana Board of Regents
2. State of Louisiana, Division of Administration
3. State Bond Commission
4. Joint Legislative Committee on the Budget

If any lay-offs of civil service employees are required, approval from the state Civil Service Commission will also be required. LSU hopes to avoid such approvals by making satisfactory voluntary arrangements with the affected employees operating the utility plant systems.

LSU will make applications for approvals from each of these agencies upon approval of this transaction by the Board. Based on the scheduled meetings of the Regents, Bond Commission, and JLCB, LSU anticipates that it can receive all approvals in sufficient time to have financial close on the transaction in January or February 2022.

In order to reduce pricing risks, CenTrio and TEP will begin seeking competitive subcontractor pricing and placing non-binding equipment orders immediately upon approval of this transaction by the Board of Supervisors. This will allow the project to begin faster and reduce the risk of inflation in construction costs and interest rates.

Construction will start almost immediately upon financial close. CenTrio and TEP expect to reach substantial completion for the improvements by May 31, 2024. They will be in default of the agreement if substantial completion is not achieved by May 30, 2025.

4. Fiscal Impact

LSU expects to save no less than \$1.3 million annually for the next 30 years under the proposed agreement. The savings from the first two years will be even higher, some \$5 million annually, because CenTrio's lower operating costs will begin immediately, while the additional charge related to financing the IMP will not begin until the IMP is completed, which is projected to be about two years from financial close of the transaction.

LSU's savings will come from 3 primary components:

- Reduced operating costs; CenTrio will operate and maintain the utility plant system for less than it costs LSU to perform the same operations
- Reduced commodity costs; the IMP will operate with greater energy efficiency than LSU's current aging equipment, resulting in reduced consumption of electricity and natural gas.
- Reduced future capital costs and emergency expenditures; without a significant capital infusion, LSU's utility plant system will continue to degrade and is expected to experience periodic catastrophic failure, which would necessitate emergency repairs or replacements, along with emergency equipment rentals to continue serving the campus. Those emergency items would cost far more over time than the plan, scheduled replacements called for in the IMP

Over the 30 year term of the proposed agreements:

- LSU will save a total of \$142,296,682 compared to its projected baseline budget
- That total has a Net Present Value of \$69,185,795

The following charts, prepared by KPMG, illustrate the total projected costs and savings.

Transaction Statistics

Project Cost Assumptions	
Initial Guaranteed Maximum Price	\$111,880,557
LSU Reimbursable Expenses	\$2,797,014
Financial Arrangement Costs	\$573,388
Total Amount Financed	\$115,250,959
Financing Assumptions	
Gearing Ratio	90.00%
Equity Return	10.00%
Debt Rate	3.30%
Debt Funded Initial Modernization Solution	\$103,725,863
Equity Funded Initial Modernization Solution	\$11,525,096
Annual Cost Basis	
Pre-Modernization Total Cost to LSU	\$24,828,916
Post-Modernization Year 1 Cost to LSU	\$28,459,036
Average Annual Cost to LSU	\$37,262,092
Minimum Annual Savings	\$1,344,202
Total Savings	\$142,296,682
NPV Savings (4% NPV Rate)	\$69,185,795

Annual Savings

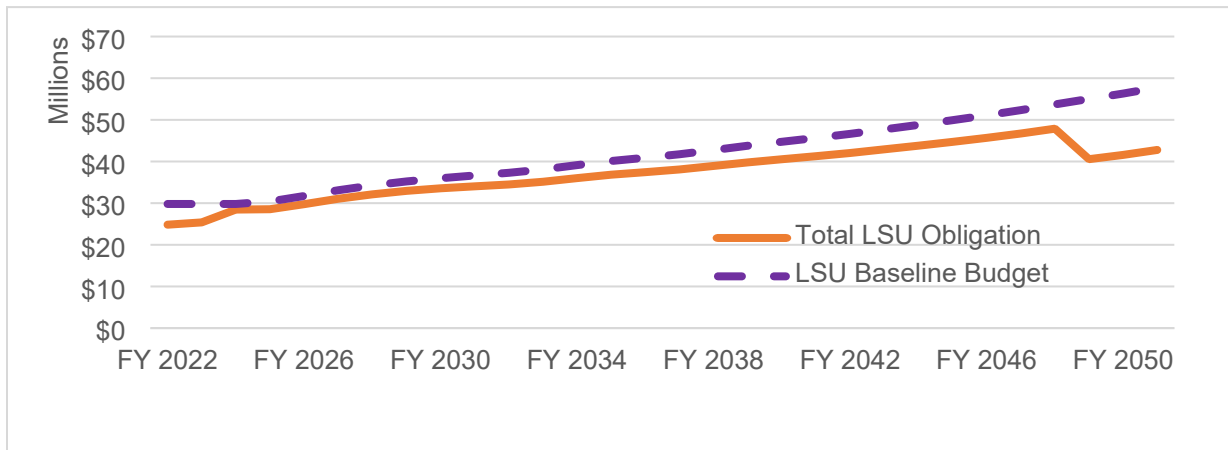

5-Year Pre and Post Initial Modernization Cost Comparison

Utilities Modernization Initiative	Year 1	Year 2	Year 3	Year 4	Year 5
	Pre-Modernization		Post-Modernization		
Capped O&M Costs	3,360,851	3,428,068	3,496,630	3,566,562	3,637,893
Initial Modernization Capital Charge	-	-	7,540,998	7,568,665	7,596,886
Total Commodities Cost	17,240,059	17,601,166	16,721,409	17,408,655	18,518,918
Cogen Settlement and Debt Service	4,228,006	4,350,884	700,000	-	-
Total LSU Obligation	24,828,916	25,380,118	28,459,036	28,543,882	29,753,697
LSU Baseline Plant Budget¹	29,803,238	29,803,238	29,803,238	30,406,770	31,711,785
Benefits Relative to Budget	4,974,322	4,423,120	1,344,202	1,862,887	1,958,088

1) Includes estimated costs for deferred maintenance

It is important to note that LSU expects to use the savings coming from the UMI to increase service levels in its facilities operations and, potentially, fund future efforts within the framework of these agreements to continue to address its deferred maintenance challenges.

5. Description of Competitive Process

LSU has conducted an extensive competitive negotiation process to reach the proposed agreement with CenTrio and TEP.

LSU had been extensively studying its utility system and the potential for a public-private partnership to increase its performance, including multiple discussions with industry-leading energy services firms. In the course of that work, LSU received proposals to provide the energy services which LSU was seeking, from two firms (CenTrio, then called Enwave, and TEP's parent entity, Louisiana Energy Partners) which each had existing energy services contracts with either LSU or the state of Louisiana. CenTrio has a contract to provide energy services to the LSU Health Sciences Center – New Orleans campus, and TEP's parent Louisiana Energy Partners has a contract with the state to provide energy services to the Shaw Center complex in downtown Baton Rouge.

September 2020

After an initial review of these two proposals, in September 2020, this Board determined that the dire condition of LSU's utilities system necessitated a rapid procurement process and directed LSU staff and its consultants to engage in competitive negotiations with each of these two firms. Complying with this directive, LSU issued a Request for Negotiated Offers to each firm, then engaged each firm in extensive negotiations intended to ensure that both firms fully understood LSU's expectations. After these competitive negotiations, each firm submitted a Best and Final Offer ("BAFO") to LSU in November 2020.

February 2021

After LSU had reviewed and evaluated each BAFO, the two firms, CenTrio and TEP, came together and proposed to LSU that they join forces to jointly provide the services needed as part of LSU's Utilities Modernization Initiative. At a special meeting held in February 2021, this Board directed LSU staff to negotiate with CenTrio and TEP to enter into a Cooperative Endeavor Agreement with all parties, and a lease with CenTrio, to provide for implementation of the Utilities Modernization Initiative. The final deal was directed to be consistent with the presentation made to the Board that day, based on the outcome of negotiations between CenTrio and TEP. The goal was to implement the Utilities Modernization Initiative, as it had been set forth in the Request for Negotiated Offers and BAFOs prepared and submitted in late 2020, with the only change being which firms would perform which services contemplated in those documents. The document presented to the Board at the February meeting is attached as Attachment 4 to this Board submission.

6. Review of Legal Documents

The documents have been negotiated by LSU and Phelps Dunbar as lead outside counsel for LSU, assisted by the Hunton law firm, a national law firm with expertise in similar deals conducted by other universities. KPMG and LSU staff have also played a substantial role in negotiation of the commercial terms. The terms of the agreements are generally as or more advantageous to the university than comparable terms included in other similar agreements between universities and energy services firms.

The drafts provided are complete in all material business terms. There are some construction-related and similar schedules to the agreements that are still in preparation, as is routine for transactions of this magnitude. Counsel for all parties will continue to review the documents prior to financial close, and some minor changes are expected in the normal course of business, particularly as CenTrio engages in more detailed discussions with its lenders, who may request or require changes as a condition of financing. No changes are anticipated that would materially affect the business and financial terms outlined in this Board submission. The resolution proposed below provides for the Board to receive copies of the final form of agreements prior to financial close.

7. Parties of Interest

LSU

LSU Real Estate & Facilities Foundation

CenTrio

Raptor Bid Co. I, a single-purpose entity owned by an investment consortium of Ullico Infrastructure Master Fund, QIC limited, and the California Public Employees' Retirement System

Tiger Energy Partners and Louisiana Energy Partners, which are each joint ventures between Bernhard, LLC and Johnson Controls

Bernhard, LLC

Bernhard, LLC's owners; currently a majority of its shares are owned or controlled by Bernhard Capital Projects and some of its key employees, shareholders, and related entities, but Bernhard Capital Partners' controlling interest is expected to be sold, prior to financial close of the transaction with LSU, CenTrio, and TEP, to DIF Capital Partners, a Netherlands-based energy investment firm

Johnson Controls

8. Related Transactions

Not applicable.

9. Conflicts of Interest

There are no known conflicts of interest between any LSU employees and consultants involved with the project and any of the private firms listed under "Parties in Interest", above.

10. Attachments

1. Transmittal Memo
2. Savings Analysis
3. Scope of Work Summary for IMP
4. February 2021 Board presentation
5. Draft CEA
6. Draft Prime Lease
7. Draft Long Term Sublease and Concession Agreement

RESOLUTION

NOW, THEREFORE, BE IT RESOLVED that the Board of Supervisors of Louisiana State University and Agricultural and Mechanical College hereby authorizes the LSU President, or the President's designee, to execute and approve the following agreements and documents:

1. A Cooperative Endeavor Agreement between LSU, CenTrio, TEP, and UMLLC providing for implementation of LSU's Utilities Modernization Initiative;
2. A Long Term Lease and Concession Agreement (the "Prime Lease") providing for the leasing of the utility plant system and related facilities by LSU to UMLLC, financing and construction of the Initial Modernization Project, the long-term operation of LSU's utility plant system, and future construction projects within the utility plant system and distribution system;
3. A Long Term Sub-lease and Concession Agreement between UMLLC and CenTrio providing for subleasing of the utility plant system and related facilities by UMLLC to CenTrio and for such other matters as set forth in the Prime Lease; and
4. Such other agreements, documents, approvals, and consents as are reasonably necessary to accomplish LSU's Utilities Modernization Initiative and for all other purposes set forth in this Resolution; and

BE IT FURTHER RESOLVED that all agreements authorized by this Resolution shall be contain terms that are as or more advantageous to LSU than the form of agreements and the business and financial terms presented to the Board at its October 2021 meeting, and provided further that final copies of the Cooperative Endeavor Agreement, the Prime Lease, and the Long Term Sub-lease and Concession Agreement shall be transmitted by the President to the Board prior to financial close of the transaction; and

BE IT FURTHER RESOLVED that the improvements constructed pursuant to these agreements shall not constitute "Auxiliary Facilities" as defined in the General Bond Resolution adopted by the Board of Supervisors of Louisiana State University and Agricultural and Mechanical College on June 17, 1994, as supplemented and amended from time to time (the "General Bond Resolution"); and

BE IT FURTHER RESOLVED that the payment obligations of the Board of Supervisors of Louisiana State University and Agricultural and Mechanical College under these agreements shall be expressly subordinate to the payment of debt service on the Bonds (as defined in the General Bond Resolution heretofore or hereafter issued pursuant to the General Bond Resolution); and

BE IT FURTHER RESOLVED that the Board hereby determines that an Acceptable University Purpose exists, for purposes of the Uniform Affiliation Agreement, for UMLLC, as a subsidiary entity of REFF, to enter into the various agreements called for by this Resolution.



CAMPUS CORRESPONDENCE

To: William F. Tate IV, LSU President

Date: October 25, 2021

Through: Donna Torres, Interim Executive Vice President for
Finance & Administration / CFO

Through: Tony Lombardo, Associate Vice President for
Facilities & Property Oversight

From: Patrick H. Martin, V, Assistant Vice President for
Real Estate, Public Partnerships, and Compliance

A handwritten signature in blue ink, appearing to read "Patrick H. Martin, V", is written over the "From:" field.

Re: Board of Supervisors Agenda, October 29, 2021
Request from LSU A&M to authorize a Cooperative Endeavor Agreement and Lease for the
Utilities Modernization Initiative

This request will authorize the LSU President or designee to authorize a Cooperative Endeavor Agreement and Lease to implement the LSU Utilities Modernization Initiative.

I recommend that this item be included on the agenda for the October 29, 2021 LSU Board of Supervisors meeting.

Louisiana State University
 Utilities Modernization Initiative - Savings Analysis
 October 25th, 2021

Annual Estimated Savings - Comparison of Initial Guaranteed Maximum Price ("IGMP") to LSU Estimated Budget

Estimated Savings: FY2022 - FY2031	FY 2022	FY 2023	FY 2024	FY 2025	FY 2026	FY 2027	FY 2028	FY 2029	FY 2030	FY 2031
Capped O&M Costs ¹	3,360,851	3,428,068	3,496,630	3,566,562	3,637,893	3,710,651	3,784,864	3,860,562	3,937,773	4,016,528
Initial Modernization Capital Charge ¹	-	-	7,540,998	7,568,665	7,596,886	7,625,671	7,655,032	7,684,980	7,715,527	7,746,685
Estimated Commodities Cost	17,240,059	17,601,166	16,721,409	17,408,655	18,518,918	19,722,061	20,674,302	21,404,714	21,913,160	22,273,818
Cogen Settlement and Debt Service	4,228,006	4,350,884	700,000	-	-	-	-	-	-	-
Total LSU Obligation	24,828,916	25,380,118	28,459,036	28,543,882	29,753,697	31,058,383	32,114,199	32,950,256	33,566,460	34,037,032
LSU Estimated Budget ²	29,803,238	29,803,238	29,803,238	30,406,770	31,711,785	33,097,315	34,262,210	35,211,979	35,977,547	36,645,626
Savings Relative to Budget	4,974,322	4,423,120	1,344,202	1,862,887	1,958,088	2,038,932	2,148,011	2,261,724	2,411,088	2,608,594

Estimated Savings: FY2032 - FY2041	FY 2032	FY 2033	FY 2034	FY 2035	FY 2036	FY 2037	FY 2038	FY 2039	FY 2040	FY 2041
Capped O&M Costs ¹	4,096,859	4,178,796	4,262,372	4,347,619	4,434,572	4,523,263	4,613,728	4,706,003	4,800,123	4,896,126
Initial Modernization Capital Charge ¹	7,778,466	7,810,883	7,843,948	7,877,675	7,912,076	7,947,165	7,982,956	8,019,462	8,056,699	8,094,681
Estimated Commodities Cost	22,608,297	23,145,766	23,905,323	24,608,038	25,092,216	25,617,571	26,335,762	27,057,038	27,684,424	28,282,737
Cogen Settlement and Debt Service	-	-	-	-	-	-	-	-	-	-
Total LSU Obligation	34,483,623	35,135,445	36,011,643	36,833,333	37,438,864	38,087,999	38,932,446	39,782,503	40,541,246	41,273,543
LSU Estimated Budget ²	37,285,789	38,094,800	39,133,759	40,119,353	40,900,144	41,737,920	42,741,438	43,784,711	44,734,173	45,654,763
Savings Relative to Budget	2,802,166	2,959,355	3,122,116	3,286,020	3,461,280	3,649,920	3,808,992	4,002,208	4,192,926	4,381,221

Estimated Savings: FY2042 - FY2051	FY 2042	FY 2043	FY 2044	FY 2045	FY 2046	FY 2047	FY 2048	FY 2049	FY 2050	FY 2051
Capped O&M Costs ¹	4,994,048	5,093,929	5,195,808	5,299,724	5,405,718	5,513,833	5,624,109	5,736,591	5,851,323	5,968,350
Initial Modernization Capital Charge ¹	8,133,422	8,172,938	8,213,244	8,254,356	8,296,291	8,339,064	8,382,693	-	-	-
Estimated Commodities Cost	28,912,746	29,654,443	30,385,425	31,156,638	31,973,555	32,864,266	33,869,191	34,821,833	35,731,314	36,805,290
Cogen Settlement and Debt Service	-	-	-	-	-	-	-	-	-	-
Total LSU Obligation	42,040,216	42,921,309	43,794,476	44,710,718	45,675,564	46,717,163	47,875,993	40,558,424	41,582,638	42,773,640
LSU Estimated Budget ²	46,632,975	47,708,993	48,782,141	49,917,560	51,092,013	52,332,861	53,701,969	55,023,559	56,308,797	57,748,783
Savings Relative to Budget	4,592,760	4,787,684	4,987,665	5,206,842	5,416,449	5,615,698	5,825,976	14,465,135	14,726,159	14,975,143

1) Estimates based on current\ conditions. Subject to change prior to commercial and financial close

2) Includes estimates for deferred maintenance

HIGHLAND PLANT UPGRADES

- **Building Addition (~5,800-sf.) and Site Upgrades**
 - Structural
 - Plumbing
 - Fire Protection
 - HVAC
- **Chilled Water System**
 - Demo:
 - Existing two (2) 170-T Chillers and associated branch piping and auxiliary components.
 - Existing CHW Pumps (primary and secondary)
 - Reuse:
 - Existing 1,500-T VFD Chiller (York-JCI) – 4,160-V.
 - New:
 - Four (4) 2,100-T Chillers (480-V); Efficiency 0.560-kW/ton; 42.0-F LEWT; 86.0-F ECWT.
 - Three (3) expandable to four (4) Variable Primary Pumps (600-MHP each)
- **Tower Water System**
 - Demo:
 - Existing four (4) cell cooling tower
 - Existing pumps.
 - New:
 - Ten (10) 1,050-T cells (50-MHP)
 - Individual Basins equalized to common supply header.
 - Three (3) expandable to four (4) Pumps (250-MHP each)
- **Heating Water System**
 - Demo:
 - Existing two (2) heating water pumps.
 - New:
 - Two (2) heating water pumps (75-MHP-VFD rated motor for future Variable Flow conversion).

MAIN PLANT UPGRADES

- **Building Addition and Site Upgrades**
 - Structural
 - Plumbing
 - Fire Protection.
 - HVAC
- **Chilled Water System**
 - Demo:
 - Existing gas turbine chiller (CH-6) and all associated components.
 - Existing electric chillers (CH-1, 2, 3, 4, 5, & 7).
 - Existing Primary Pumps
 - Five (5) primary pumps
 - Existing Secondary Pumps
 - Southeast Loop - three (3)
 - East Loop - three (3)
 - Northwest Loop – two (2)
 - Quad (East and West) Loop – three (3)
 - Southwest Loop – two (2)
 - Reuse:

- Existing Chillers (CH-8, 9, & 10 - Steam Turbine driven); one designated for backup service.
 - Existing Secondary Pumps (Alternate) in PMAC – two (2). Refer to Campus Distribution System.
 - New:
 - Three (3) 2,100-T Chillers (480-V); Efficiency 0.560-kW/ton; 42.0-F LEWT; 86.0-F ECWT.
 - Three (3) 1,800-T Chillers (4,160-V); Efficiency 0.595-kW/ton; 42.0-F LEWT; 86.0-F ECWT.
 - Five (5) Variable Primary Pumps (600-MHP each)
- **Tower Water System**
 - Demo:
 - Existing two (2) cell counterflow tower (serves CH-6) and vertical turbine pumps and existing concrete basin.
 - Existing seven (7) cell (serves CH-1, 3, and 5) crossflow tower and associated pumps and existing structural frame.
 - Existing TWR pumps serving existing five (5) cell crossflow cooling tower (serves CH-2,4,7).
 - Reuse:
 - Existing four (4) cell counterflow tower and associated pumps serving existing steam turbine chillers. No scope with this system.
 - Existing five (5) cell crossflow tower (CH-2,4,7).
 - New:
 - Six (6) 1,050-T cells (50-MHP/cell)
 - Four (4) TW Pumps (250-MHP each).
- **Steam/Condensate**
 - Demo:
 - Existing gas turbine chiller (CH-6) HRSG and associated components.
 - Existing Boiler B-6 (Exterior – Abandoned) and associated components.
 - Existing Boiler B-4 and associated components.
 - Existing two (2) Condensate Transfer pumps
 - Reuse:
 - Existing condensate surge tank – Upgrade to serve as backup deaerator.
 - Upgrade make-up water (100% make-up) for emergency service (400-gpm)
 - Upgrade steam heat (larger pipe size and thermal regulator and steam injector).
 - Controls temperature and level controls
 - New
 - 175-kPPH steam boiler. Low NOx – 9-ppm. Watertube with integral stack economizer.
 - Deaerator (175-kPPH), 4,000-gall storage tank, four (4) feedwater pumps (each at 265-gpm@450-ft; 50-MHP), size for constant speed (with minimum flow recirculation lines) for modulating feedwater control.
 - New Condensate Transfer Pumps for CST: two (2) pumps each at 540-gpm@450-ft; 100-MHP. Variable speed control with minimum flow recirculation lines. .

CAMPUS DISTRIBUTION SYSTEM

- **Chilled Water System**
 - Highland Plant Main Piping
 - 36-inch main with two (2) connections
 - First to existing 20-inch in Highland plant.
 - Second to 14-inch below grade SE loop connection
 - 30-inch valve and cap for future extension to Science Building Loop.
 - NW Loop (Alternate)

- Option A – Replace 14-inch piping with 24-inch piping
 - Option B – Provide need 18-inch piping directional bore to PMAC plant.
- Quad Loop (Alternate)
 - Option A – Replace 12-inch with 20-inch service within tunnel
 - Option B - Replace 12-inch with 20-inch service as directional boring. Not shown on drawings.
- Future Considerations
 - 30-inch connection from Highland plant to Science Building Loop
 - 30-inch connection to Main Plant from Science Building Loop

PDC / CHAMPIONS SUBSTATION EXPANSION

- Extend 69kV transmission line.
- New 69kV, 420A circuit switcher.
- New 69kV-13.8kV, 24/32/40 MVA substation transformer, includes fire wall.
- New 13.8kV, 3000A bus switchgear in outdoor, conditioned electrical house.
 - Includes provisions for future co-gen.
 - Includes provisions for future loop circuits.
 - Includes breakers for Highland plant.
 - Includes breaker for substation auxiliary power.
 - Includes 2000A main and 3000A tie breakers.
 - Includes 3000A cable bus or bus duct to existing 13.8kV switchgear.
 - Includes automatic throwover controls between new mains, existing mains, new tie, and existing tie breakers.
 - Includes updating and modification of existing bus differential system.



LSU UTILITIES MODERNIZATION

EACH COMPANY'S OPERATIONAL STRENGTHS

Enwave

- Largest core competency district energy platform in N.A.
- Proven campus infrastructure reliability and resiliency
- Broadest district energy system portfolio of green technologies

LA Energy Partners

- Unparalleled Louisiana district energy experience
- Sustainable and energy efficient design and construction
- Vast local design and construction resources

Extensive higher education experience

Firm commitment to diverse suppliers

Decades long service to LSU

KEY DEFINITIONS

- **Initial Modernization Solution:** Immediate modernization of LSU’s Central Utility Plant and Distribution System as defined in the Request for Negotiations and Final Offer.
- **Capital Improvements (Central Utility Plant and Distribution System):** Future capital improvements related to growth and capital renewal within the Central Utility Plant (including the Main Powerhouse, Highland, the Vet Med Plant, the in-building generation assets, and any other satellite generation assets on the Baton Rouge Campus) and the Campus Distribution System. All projects are subject to LSU’s final approval.
- **Capital Improvements (Building Mechanical Systems):** Future capital improvements related to growth and capital renewal of assets within the building envelope. Represents the “load side” of the utilities infrastructure. All projects are subject to LSU’s approval.
- **Base O&M:** Operations, maintenance, and lifecycle repair of the Central Utility Plant (including the Main Powerhouse, Highland, the Vet Med Plant, the in-building generation assets, and any other satellite generation assets). Base O&M does not include the Distribution System or the Building Mechanical Systems. Base O&M is performed based on the KPI’s and levels of service within the agreement.

ENWAVE RESPONSIBILITIES

Central Utility Plant and Distribution System

- Delivery of the Initial Modernization Solution through performance of Conceptual/Schematic Design, Construction Management, and deployment of financing to the extent not otherwise assigned to LAEP. Enwave takes full responsibility for the delivery and associated risks.
- Performance of Base O&M based on specified KPI's and levels of service
- Opportunity to deliver Capital Improvements for the Central Utility Plant and Distribution System to the extent not otherwise assigned to LAEP (requires full LSU approval)
- Opportunity to finance Capital Improvements for the Central Utility Plant and Distribution System to the extent not otherwise assigned to LAEP (requires full LSU approval)

LOUISIANA ENERGY PARTNERS RESPONSIBILITIES

Central Utility Plant and Distribution System

- Design and construction based on the Conceptual/Schematic Design, equipment specifications, KPI's, and levels of service developed by Enwave and LSU.

Building Mechanical System

- Opportunity to deliver Capital Improvements for the Building Mechanical System (requires full LSU approval)
- Opportunity to finance Capital Improvements for the Building Mechanical System (requires full LSU approval)

LSU RESPONSIBILITIES

Central Utility Plant and Distribution System

- LSU retains responsibility for O&M on the distribution system, with the ability to transfer O&M responsibility at a later date
- LSU retains full approval rights for delivery of the Initial Modernization Solution and each Capital Improvement in the Central Utility Plant and Distribution System (including deployment of financing)

Building Mechanical System

- LSU retains responsibility for O&M on the building mechanical systems, with the ability to transfer O&M responsibility at a later date
- LSU retains full approval rights for delivery of each Capital Improvement on the Building Mechanical System (including deployment of financing)

COOPERATIVE ENDEAVOR AGREEMENT

dated as of _____, 20____

by and among

**Board of Supervisors of the
Louisiana State University and Agricultural and Mechanical College,**

Utilities Modernization LLC,

[CenTrio], and

Tiger Energy Partners, LLC

**COOPERATIVE ENDEAVOR AGREEMENT
(LSU Utilities Modernization Initiative)**

THIS COOPERATIVE ENDEAVOR AGREEMENT (this “**UMI CEA**”) is made and entered into effective as of this ____ day of _____, 20 ____ (the “**Effective Date**”), by and among (i) the Board of Supervisors of the Louisiana State University and Agricultural and Mechanical College, herein represented by William F. Tate IV, its duly authorized President (the “**University**”), (ii) Utilities Modernization LLC, a Louisiana limited liability company (“**UMLLC**”), a wholly owned subsidiary of LSU Real Estate Facilities Foundation, a Louisiana non-profit corporation (“**REFF**”), (iii) [_____, a _____]¹ (“**CenTrio**”), and (iv) Tiger Energy Partners, LLC, a Delaware limited liability company (“**TEP**”). The University, UMLLC, CenTrio and TEP are each referred to herein as a “**Party**” and together the “**Parties**”.

WITNESSETH:

WHEREAS, Article VII, Section 14(C) of the Louisiana Constitution of 1974, as amended (the “**Constitution**”), provides that for a public purpose, the State of Louisiana (the “**State**”) and its political subdivisions, such as the University, may engage in cooperative endeavors with political subdivisions, private associations, corporations, or individuals;

WHEREAS, at the University’s flagship campus in Baton Rouge, Louisiana (the “**Campus**”), the operating costs, deferred maintenance and replacement of existing utilities assets and infrastructure (the “**Utilities Infrastructure**”, which, for purposes of this UMI CEA, shall include the Building Mechanical Systems (as defined below)) places a substantial financial burden on the University and State and exposes the University, State and those facilities to risks that materially and adversely impact the University’s ability to conduct its business, satisfy its commitments and obligations, and further its educational mission;

WHEREAS, the University has identified a need to develop and implement a comprehensive modernization, operations and maintenance solution for the Utilities Infrastructure in order to mitigate these risks, eliminate unnecessary expenditures, increase efficiencies that derive savings, establish robust levels of service for operations and maintenance, increase future budget certainty for the University, address deferred maintenance challenges, address the University’s anticipated increase in energy demand, achieve operational efficiencies, and ensure resiliency of the Utilities Infrastructure (the “**Utilities Modernization Initiative**”);

WHEREAS, in light of these goals, the University, together with its staff and advisors, have undertaken a comprehensive review and assessment of the Utilities Infrastructure and have developed a framework for achieving the Utilities Modernization Initiative with one or more private district energy services providers to make capital investments in and operate more efficiently the Utilities Infrastructure;

WHEREAS, during the evaluation of the Utilities Infrastructure and development of the Utilities Modernization Initiative by the University, its staff and advisors, the University entered

¹ CenTrio to provide.

preliminary discussions with Brookfield District Energy, USA, LLC d/b/a Enwave USA (“**Enwave**”), which has since changed its name to CenTrio Energy South LLC and rebranded as “CenTrio Energy”, and with LA Energy Partners, LLC (“**LAEP**”), an affiliate under common ownership with TEP, each of which had existing energy-related contractual relationships with the University or State and each of which expressed an interest in providing the services the University is seeking for the Utilities Modernization Initiative;

WHEREAS, Enwave began working with the University in New Orleans in 1998 and, through its existing cooperative endeavor agreement with the University, provides thermal energy services to the University’s Health Sciences Center. Enwave has spent over \$100 million constructing district energy facilities that serve the University’s Health Sciences Center and invested another \$200 million in the local economy;

WHEREAS, LAEP, which (like TEP) is a joint venture between Bernhard LLC and Johnson Controls, Inc., has deep ties to the State and, together with its affiliates or related companies, has completed over 400 projects for the University, including the design and construction of the University’s existing combined heating and power system. In addition to its University experience, LAEP also operates and maintains numerous energy plants in Louisiana, including the Shaw Center energy plant in downtown Baton Rouge pursuant to an existing cooperative endeavor agreement with the State;

WHEREAS, after working cooperatively with the University to review the Utilities Infrastructure, on April 1, 2020, each of Enwave and LAEP submitted its separate formal proposal to provide capital improvements to the Utilities Infrastructure and to take over aspects of the operations and maintenance of the Utilities Infrastructure. The University, through its staff and advisors, then undertook a comprehensive evaluation of each proposal in an effort to determine whether accepting one of the proposals would be in the University’s best interests;

WHEREAS, after considerable review of these proposals by the University’s staff and advisors, the University, at its September 2020 Board of Supervisors meeting, determined that the dire condition of the Utilities Infrastructure necessitated an expedited procurement of an appropriate private partner so that the Utilities Modernization Initiative could be implemented as quickly as possible. Based on this policy decision, the University, through its staff and advisors, commenced a 90-day negotiation and competitive proposal process with both Enwave and LAEP by issuing a Request for Negotiations and Final Offer to Enwave and LAEP on October 16, 2020 (as amended and supplemented, the “**RFO**”), to determine whether a competitive, negotiated transaction with either party would be in the University’s best interest, or whether an open public competitive process, involving a request for qualifications and request for proposals, would be in the University’s best interest;

WHEREAS, in response to the RFO, on November 25, 2020, each of Enwave and TEP submitted its Best and Final Offer dated November 25, 2020 (each a “**BAFO**”) to the University, each of which included, among other things, a term sheet outlining the technical, commercial and financial terms on which Enwave and TEP, respectively, proposed to accomplish the Utilities Modernization Initiative for the University;

WHEREAS, each BAFO was carefully evaluated and analyzed by the University’s staff and advisors, and, after considering the results of that evaluation and the recommendation from its staff and advisors, the University approved and directed, by resolution of the Board of Supervisors at its February 23, 2021 meeting, “the initiation of a cooperative endeavor agreement between the University, the Real Estate & Facilities Foundation (REFF), Enwave, and the Louisiana Energy Partners, as well as the leasing of utility infrastructure to REFF,” in order to implement the Utilities Modernization Initiative (the “**Resolution**”);

WHEREAS, the Parties desire to enter into this UMI CEA, to serve as the “cooperative endeavor agreement” referenced in the Resolution, to memorialize the cooperative intent among the University, UMLLC (a newly formed, wholly owned subsidiary of REFF), CenTrio and TEP to design, develop and implement improvements to the Campus utility system, and to establish generally the transaction framework for the implementation of the Utilities Modernization Initiative; and

NOW, THEREFORE, in consideration of the mutual covenants herein contained, and intending to be legally bound, the Parties agree as follows:

ARTICLE 1
INTERPRETATION

Section 1.1 Recitals. The Parties hereby agree and acknowledge that the foregoing recitals are true and correct and hereby incorporate the same into this UMI CEA as if fully set forth herein.

Section 1.2 Use of Defined Terms. Capitalized terms defined in this UMI CEA shall have their defined meanings when used herein and in any document, certificate, report or agreement furnished from time to time in connection with this UMI CEA unless the context otherwise requires.

Section 1.3 Rules of Interpretation. Unless the context clearly indicates to the contrary, the following rules shall apply to the interpretation and construction of this UMI CEA:

(a) Words importing the singular number shall include the plural number and vice versa.

(b) All references herein to particular articles or sections are references to articles or sections of this UMI CEA.

(c) The captions and headings herein are solely for convenience of references and shall not constitute part of this UMI CEA, nor shall they affect its meaning, construction or effect.

(d) The terms “hereby,” “hereof,” “hereto,” “herein,” “hereinbelow,” “hereunder,” or any similar terms as used in this UMI CEA refer to the UMI CEA in its entirety and not the particular article or section of this UMI CEA in which they appear, and the term “hereafter” means after and the term “heretofore” means before the date of execution of this UMI CEA.

(e) The words “include”, “includes” and “including” or any similar terms as used in this UMI CEA will be deemed to be followed by the phrase “without limitation” or words of similar effect.

(f) Any reference herein to any person, or to any person in a specified capacity, will be construed to include such person’s successors and assigns or such person’s successors in such capacity, as the case may be (subject to any restrictions on assignment set forth in this UMI CEA or any Project Agreement).

ARTICLE 2 AUTHORITY AND PUBLIC PURPOSE

Section 2.1 Authority of State and University. As provided by Article VII, Section 14(C) of the Constitution, the University may enter into cooperative endeavor agreements with political subdivisions, private associations, corporations, or individuals for a public purpose, including agreements which may require the use of State funds, personnel or other resources, provided that applicable legal guidelines are met and that the State benefits of such an agreement are demonstrated to be commensurate with or greater than the investment of funds by the State. The University has the constitutional or statutory authority to enter into this UMI CEA, based on the representations, agreements and undertakings set forth herein. The University has provided to each of CenTrio and TEP duly executed authorizing resolutions of its Board of Supervisors evidencing the authority of the undersigned representative to enter into this UMI CEA on behalf of the University. The University represents that, as of the Effective Date, there is no action, suit, investigation or proceeding pending, or to its best knowledge, threatened, against the University before any court, arbitrator, or administrative or governmental body, or insurance underwriting agency that might adversely affect the ability of the University to comply with its obligations hereunder or in connection with the transactions contemplated hereby or by the Project Agreements.

Section 2.2 Authority of CenTrio and TEP. Each of CenTrio and TEP has provided to the University a copy of its organizational documents (e.g., as applicable, articles of incorporation, articles of organization, certificate of formation, bylaws, limited liability company agreement), a certificate of good standing from its state of formation and (if applicable) a certificate from the State authorizing it to conduct business within the State, and duly executed authorizing resolutions evidencing the authority and representation of CenTrio and TEP, respectively, by the undersigned representatives, such documents collectively demonstrating the authority of each of CenTrio and TEP to enter into this UMI CEA, to carry out the commitments made herein, and the authority of the undersigned representative to execute this UMI CEA on behalf of CenTrio and TEP, respectively. Each of CenTrio and TEP represents that, as to itself as of the Effective Date, there is no action, suit, investigation or proceeding pending, or to its best knowledge, threatened, against such Party, before any court, arbitrator, or administrative or governmental body, or insurance underwriting agency that might result in a material adverse change in the financial condition or operations of such Party or that might adversely affect the ability of such Party to comply with its obligations hereunder or in connection with the transactions contemplated hereby or by the Project Agreements (as defined below).

Section 2.3 Public Purpose. The Parties hereby acknowledge and represent that the Utilities Modernization Initiative, as implemented through the Project Agreements, will serve the following public purposes, among others:

- (a) Mitigating the operating costs, deferred maintenance and replacement costs associated with certain portions of the Utilities Infrastructure, thereby relieving a substantial financial burden of the University and State;
- (b) Increasing future budgetary certainty for the University and State relative to the Utilities Infrastructure;
- (c) Increasing operational efficiencies that are expected to derive savings to the University and State;
- (d) Shifting certain risks associated with certain portions of the Utilities Infrastructure, its condition and its operation away from the University and State;
- (e) Ensuring robust levels of service, system resiliency and reliability for the University and its students, faculty, researchers, administration, staff and visitors; and
- (f) Addressing the University's anticipated increase in energy demand over the term of the applicable Project Agreements.

Section 2.4 Net Public Benefit. The Parties hereby acknowledge and represent that the Utilities Modernization Initiative, as implemented through and as more fully set forth in the Project Agreements, will result in a net public benefit to the University, State and its citizens that will exceed the value of the obligations of the University and State thereunder, so that all obligations and expenditures by the University and State under the Project Agreements will not be gratuitous donations.

ARTICLE 3 PROJECT AGREEMENTS

Section 3.1 Generally. The Parties intend to set forth their respective rights and obligations with respect to the Utilities Modernization Initiative through various documents and binding agreements (each a "**Project Agreement**" and collectively, the "**Project Agreements**"), including those outlined below. References to terms and provisions of certain of the Project Agreements as set forth below are descriptive only and, in the event of any conflict between the terms and provisions referenced below and the actual terms and provisions set forth in the Project Agreements, the Project Agreements shall control. Further, the description of the Project Agreements set forth below are not all-inclusive and reference is made to each Project Agreement for the specific terms, conditions, provisions, and rights and obligations of the respective parties to each Project Agreement.

Section 3.2 Project Agreements. As of the Effective Date:

(a) Prime Lease. The University and UMLLC shall enter into a Long-Term Lease and Concession Agreement (the “**Prime Lease**”) pursuant to La. R.S. 17:3361 *et seq.* and which, among other things:

(i) Defines those portions of the Utilities Infrastructure (excluding the Building Mechanical Systems) leased by the University to UMLLC, consisting generally of the Campus’ central utility plant assets and certain other specifically identified distribution assets more fully described on Exhibit A attached hereto and incorporated herein by reference (collectively, the “**Thermal Assets**”);

(ii) Provides for a term of thirty (30) years;

(iii) Requires UMLLC to cause to be performed operations and maintenance services for the Thermal Assets, subject to certain performance standards and key performance indicators, and procurement advisory services relating to Campus energy supply;

(iv) Requires UMLLC to cause to be constructed, completed and delivered initial modernization capital improvements to the Thermal Assets based on a preliminary design and on a guaranteed maximum price basis, and addresses the initial transition of operations and maintenance of Thermal Assets during the construction and delivery process;

(v) Provides a framework for collaboration among the University, UMLLC and CenTrio to periodically review, identify and implement potential upgrades and further capital improvements to the Utilities Infrastructure (excluding the Building Mechanical Systems); and

(vi) Requires the University to (A) pay to UMLLC an all-in utilities fee, comprised of operations and maintenance service charges and capital recovery charges for completed Utilities Infrastructure capital projects, and (B) provide, or cause to be provided, commodities required for the operation and maintenance of the Thermal Assets.

(b) Sublease. UMLLC and CenTrio shall enter into a Long-Term Sub-Lease and Concession Agreement (the “**Sublease**”) pursuant to La. R.S. 17:3361 *et seq.* and which, among other things:

(i) Defines those portions of the Utilities Infrastructure subleased by UMLLC to CenTrio, consisting of the Thermal Assets leased by the University to UMLLC in the Prime Lease;

(ii) Provides for a term of thirty (30) years;

(iii) Requires CenTrio to perform operations and maintenance services for the Thermal Assets, subject to certain performance standards and key performance indicators, and to perform procurement advisory services relating to Campus energy supply;

(iv) Requires CenTrio to cause to be constructed, completed and delivered initial modernization capital improvements to the Thermal Assets based on a preliminary design and on a guaranteed maximum price basis, and addresses the initial transition of operations and maintenance of the Thermal Assets during the construction and delivery process;

(v) (1) Provides a framework for collaboration among the University, UMLLC and CenTrio to periodically review, identify and implement potential upgrades and further capital improvements to the Utilities Infrastructure (excluding the Building Mechanical Systems), and (2) to the extent the University and UMLLC have approved CenTrio's plan to implement and deliver certain future capital improvements to the Thermal Assets, directs CenTrio to engage TEP for the construction, completion and delivery of such future capital improvements, subject in all cases to (x) the University's and UMLLC's right to implement such future capital improvements using capital outlay funds conditioned upon a competitive bid or other public procurement process, and (y) CenTrio's right to engage a contractor other than TEP for the construction, completion and delivery of such future capital improvements (I) if TEP declines, in writing, to participate in the applicable project, or (II) if doing so would be in the University's best interest. If the University desires that CenTrio engage a non-TEP contractor as contemplated in subclause (II) above, it shall provide written notice of such intent to CenTrio and TEP together with its detailed reasoning therefor, and TEP shall have thirty (30) days following receipt of such notice to provide its written response to the University and CenTrio. Following receipt of TEP's written response or TEP's failure to timely respond, the University's senior official(s) (as designated and appointed from time to time by the President of the University pursuant to the Prime Lease) shall make a final, binding and non-appealable determination.

(vi) Requires that UMLLC (A) pay to CenTrio an all-in utilities fee, comprised of operations and maintenance service charges and capital recovery charges for completed Utilities Infrastructure capital projects, and (B) provide, or cause to be provided, commodities required for the operation and maintenance of the Thermal Assets; and

(vii) Directs CenTrio to enter into a design-build contract with TEP (the "**Drop-Down DB Contract**") for the final design, construction, completion and delivery of the initial modernization capital improvements to the Thermal Assets based on the preliminary design referenced above; provided that the Drop-Down DB Contract, as well as the final design of the improvements covered thereby, shall be subject to the University's and UMLLC's review and approval.

Section 3.3 Building Mechanical Systems. The Project Agreements described in Section 3.2 above will not cover, and the Prime Lease and Sublease will not grant leasehold interests in, those Campus "in-building" mechanical systems more fully described on Exhibit B attached hereto and incorporated herein by reference (collectively, the "**Building Mechanical Systems**"). TEP shall have the right to make the first proposal for any future capital improvements or upgrades to the Building Mechanical Systems and the financing thereof; provided, however,

that such right shall not apply with respect to any Building Mechanical Systems located within Campus buildings owned by or long-term leased to third parties; and provided further that the University shall at all times retain the right to procure similar upgrades, improvements, repairs or replacements to the Building Mechanical Systems without TEP's involvement (i) using capital outlay funds conditioned upon a competitive bid or other public procurement process, (ii) in emergency situations in order to restore functionality to in-building systems following unforeseen damage, equipment failure or interruption of service, (iii) with respect to the University's existing or future Auxiliary Services facilities (defined and limited to student housing, athletics facilities, the LSU Student Union, LSU Dining, and Barnes & Noble at LSU), or (iv) in connection with existing or future ground-up construction projects currently underway or initiated in the future (collectively, the "**BMS Project Exclusions**"). The Project Agreements related to any future capital improvements or upgrades to the Building Mechanical System to be implemented by TEP shall be set forth in a contractual document, and shall be formalized and executed upon the approval of the University to undertake such Building Mechanical System upgrades (a "**BMS Project Agreement**"). Any BMS Project Agreement shall provide a framework for collaboration among the University and TEP to periodically review, identify and implement potential upgrades and capital improvements to the Building Mechanical Systems, subject in all cases to the BMS Project Exclusions. Any BMS Project Agreement shall (x) be subject in all respects to the University's consent and approval and (y) comply with all applicable laws, statutes, rules, ordinances or regulations relative to the structure, implementation and financing of such capital improvements or upgrades.

ARTICLE 4 TERM

Section 4.1 Term. The term of this UMI CEA shall commence as of the Effective Date and shall expire upon the thirtieth (30th) anniversary of the Effective Date. Notwithstanding the foregoing, (i) this UMI CEA may be terminated upon the mutual written consent of all Parties hereto, and/or (ii) CenTrio's or TEP's participation in this UMI CEA may be terminated by the University as provided in Section 4.2 below.

Section 4.2 Termination of Participation by a Party.

(a) CenTrio's participation in this UMI CEA may be terminated by the University, at the University's election upon written notice to all other Parties hereto, (i) upon the natural expiration of the Sublease, or (ii) upon the University's termination of the Sublease due to a default by CenTrio or any affiliate of CenTrio pursuant to the terms and conditions thereof (including all applicable notice and cure periods). Upon any such termination, CenTrio shall have no further rights hereunder, and this UMI CEA shall continue in full force and effect by and among the other Parties hereto. Notwithstanding any termination of CenTrio's participation in this UMI CEA, any other Project Agreement to which CenTrio remains a party shall continue in accordance with its terms and conditions unless and until terminated as provided in such Project Agreement.

(b) TEP's participation in this UMI CEA may be terminated by the University, at the University's election upon written notice to all other Parties hereto, (i) upon the natural expiration of any BMS Project Agreement, or (ii) upon the University's termination

of a BMS Project Agreement due to a default by TEP or any affiliate of TEP pursuant to the terms and conditions thereof (including all applicable notice and cure periods). Upon any such termination, TEP shall have no further rights hereunder, and this UMI CEA shall continue in full force and effect by and among the other Parties hereto. Notwithstanding any termination of TEP's participation in this UMI CEA, any other Project Agreement to which TEP remains a party shall continue in accordance with its terms and conditions unless and until terminated as provided in such Project Agreement.

ARTICLE 5 DIVERSITY AND INCLUSION

Section 5.1 Diversity and Inclusion. The Parties understand that the University is committed to promoting the growth and development of minority- and women-owned and small and historically underutilized businesses (collectively, "**Diverse Businesses**") by providing opportunities to participate in University agreements. In support of this commitment, each of CenTrio and TEP (i) shall develop and implement a Diversity, Inclusion and Equity Plan, to be attached to its respective Project Agreements, outlining such Party's commitment and obligation to provide opportunities to Diverse Businesses that are either certified by the State or another certifying entity in a diverse category as a contractor, subcontractor, supplier, or capital provider under the Project Agreements, (ii) shall provide to the University, on a quarterly basis during the term of this UMI CEA, a list of all Diverse Businesses engaged or utilized by such Party in connection with the Utilities Modernization Initiative, which list shall identify as to each Diverse Business contained thereon (A) the legal name thereof, (B) the principal office or address, (C) ownership and (D) the services, goods or capital provided or supplied (or to be provided or supplied) and the value of the services, goods or capital procured therefrom, and (iii) following written notice from the University, take all other reasonable measures required by the University to ensure accountability, compliance and transparency in complying with the commercially reasonable, University system-wide disadvantaged business enterprise goals or policies established by University's Office of Supplier Diversity, all in connection with the Utilities Modernization Initiative. To the extent that any law, rule or regulation would require that this Section be modified or voided, the Parties agree that such provision can be amended or severed from this UMI CEA without affecting any of the other terms hereof.

ARTICLE 6 MISCELLANEOUS

Section 6.1 Successors and Assigns; Assignment. This UMICEA shall be binding upon and shall inure solely to the benefit of the Parties hereto and their respective permitted successors and assigns, and not to the benefit of any other third parties. Neither CenTrio, TEP nor UMLLC may assign, transfer or convey this UMI CEA or any interest herein without the express written consent of the University, and any such assignment, transfer or conveyance made or given without first obtaining the University's prior written consent shall be null and void; provided, however, that (i) the foregoing prohibition on assignment of this UMI CEA shall not prohibit a Party's assignment of a Project Agreement to the extent expressly permitted by such Project Agreement; (ii) CenTrio may assign its interest in this UMI CEA, without the consent of the other Parties hereto, in connection with a permitted assignment of the Sublease accomplished in accordance with the terms and conditions of the Sublease; and (iii) TEP may assign its interest in this UMI

CEA, without the consent of the other Parties hereto, in connection with a permitted assignment of a BMS Project Agreement accomplished in accordance with the terms and conditions of such BMS Project Agreement.

Section 6.2 Audit. The Legislative Auditor of the State may audit any and all books and records of CenTrio and TEP related to this UMI CEA or the Project Agreements, and CenTrio and TEP shall make such books and records available for such purpose upon reasonable notice during reasonable business hours.

Section 6.3 Waiver. No delay or failure of any Party in exercising any right, power, or privilege under this UMI CEA, nor any single or partial exercise thereof or abandonment or discontinuance of steps to enforce such a right, power, or privilege under this UMI CEA, shall preclude any further exercise thereof. Any waiver, consent, or approval of any kind or character on the part of any Party of any breach or default under this UMI CEA, or any waiver of any provision or condition of this UMI CEA, must be in writing and shall be effective only to the extent specifically set forth in such writing.

Section 6.4 Entire Agreement. This UMI CEA and the appendices hereto shall constitute the entire understanding between the Parties with respect to the subject matter hereof, superseding all negotiations, prior discussions, and preliminary agreements. There is no representation or warranty of any kind made in connection with the transactions contemplated hereby that is not expressly contained in this UMI CEA.

Section 6.5 Notices. All notices and demands delivered pursuant to this UMI CEA shall be in writing and shall be given by (i) registered or certified mail, return receipt requested, or (ii) recognized overnight delivery service providing positive tracking of items (e.g., Federal Express), or (iii) personal delivery to and receipt by the person to whom delivered, or (iv) telecopy with receipt confirmed by telephone, in each case addressed or telecopied as follows, or at such other address or telecopy number of a party shall have given notice as herein provided:

If to the University:

LSU Facility Services
201 Facilities Services Bldg.
Engineering Lane
Baton Rouge, LA 70803
Telephone: (225) 578-6832
Email: pmartin@lsu.edu
Attention: Patrick Martin, Assistant Vice President,
Real Estate, Public Partners, & Compliance

with a copy to:

Board of Supervisors of Louisiana State University
and Agricultural and Mechanical College
3810 West Lakeshore Drive, Suite 124
Baton Rouge, LA 70808
Telephone: (225) 578-4126
Facsimile: (225) 578-5524
Email: wdecuirjr@lsu.edu
Attention: Winston DeCuir, General Counsel

and with a copy to:

Phelps Dunbar, L.L.P.
II City Plaza
400 Conventional Street, Suite 1000
Baton Rouge, LA 70802
Telephone: (225) 346-0285
Facsimile: (225) 381-9197
Email: ragan.richard@phelps.com and
dennis.blunt@phelps.com
Attention: P. Ragan Richard and Dennis Blunt

If to UMLLC:

LSU Foundation
3796 Nicholson Drive
Baton Rouge, LA 70802
Telephone: (225) 578-3811
Facsimile: (225) 578-0530
Email: lgreco@lsufoundation.org
Attention: Leu Anne Greco, Vice President &
General Counsel

If to CenTrio:²

Telephone: _____
Facsimile: _____
Email: _____
Attention: _____

² CenTrio to provide.

With a copy to: _____

Telephone: _____
Facsimile: _____
Email: _____
Attention: _____

If to TEP: Tiger Energy Partners, LLC
8555 United Plaza Blvd., Suite 201
Baton Rouge, LA 70809
Telephone: (225) 706-2207
Email: msamuel@bernhard.com
Attention: Melissa Samuel

With a copy to: Bernhard, LLC
1 Allied Drive, Suite 2600
Little Rock, AR 72202
Telephone: (501) 666-6776
Email: etinsley@bernhard.com
Attention: Ed Tinsley

All such notices and documents shall be deemed to have been sufficiently given for all purposes hereof only upon receipt by the party to whom such notice is sent (in the case of telecopy, during normal business hours). Notices by the Parties may be given, but not received, on their behalf by their respective attorneys. With respect to all notices and demands given as set out above, a courtesy copy (which shall not constitute notice) will be sent simultaneously by email to each party to whom the notice or demand is directed.

Section 6.6 Amendments, Supplements, and Modifications. This UMI CEA may not be amended, supplemented, or modified, except in writing and executed by all Parties hereto; provided, however, that (i) a Project Agreement may be amended, supplemented or modified in accordance with the applicable terms and conditions of such Project Agreement, and (ii) execution by one or more Parties of a Project Agreement following the Effective Date (including the BMS Project Agreement and any amendment, supplement or modification to any existing or future Project Agreement) shall not require amendment or modification to this UMI CEA.

Section 6.7 Governing Law, Jurisdiction and Venue. This UMI CEA shall be deemed to be made in the State of Louisiana. This UMI CEA will be interpreted, and the rights and liabilities of the Parties hereto determined, in accordance with the laws of the State of Louisiana without regard to principles of conflicts of law. Each Party irrevocably submits to the exclusive jurisdiction in the 19th Judicial District Court for the Parish of East Baton Rouge, or the federal district court encompassing East Baton Rouge Parish, in any action or proceeding arising out of or relating to this UMI CEA and waives any objection which it may have at any time to the laying of venue in such court and any claim that such action or proceeding has been brought in an inconvenient forum.

Section 6.8 Severance. To the fullest extent possible, each provision of this UMI CEA shall be interpreted in such manner as to be effective and valid under applicable law, but if any provision or a portion of any provision of this UMI CEA shall be prohibited or invalid under such law, such provision shall be ineffective to the extent of such prohibition or invalidity without invalidating the remainder of such provision or the remaining provisions of this UMI CEA.

Section 6.9 No Personal Liability. No covenant or agreement contained in this UMI CEA shall be deemed to be the covenant or agreement of any member, official, trustee, officer, agent or employee of any Party in his or her individual capacity, and neither the officers thereof nor any official executing this UMI CEA shall be liable personally with respect hereto or be subject to any personal liability or accountability by reason of the execution and delivery of this UMI CEA on behalf of any Party.

Section 6.10 No Partnership. Nothing contained in this UMI CEA shall be deemed or construed to create the relationship of principal and agent or of partnership or joint venture among or between any of the Parties hereto.

Section 6.11 Limitation on Liability. The provisions of this UMI CEA do not waive or abrogate, nor are they intended to waive or abrogate, any limitation of liability for the University provided by Louisiana law, including without limitation under La. R.S. 13:5106.

Section 6.12 Captions. The captions or headings in this UMI CEA are for convenience only and in no way define, limit or describe the scope or extent of any of the provisions of this UMI CEA.

Section 6.13 Further Assurances. From time to time, and at any time, at and after the Effective Date, each Party will execute, acknowledge and deliver such documents and assurances, reasonably requested by any other Party (in such form and substance reasonably acceptable to the requested Party) and will take any other action consistent with the terms of this UMI CEA that may be reasonably requested by a Party for the purpose of effecting or confirming any of the terms and provisions hereof. Notwithstanding the foregoing, no Party shall be required to execute or deliver any documents or take any action that decreases the rights or increase the obligations of such Party under this UMI CEA.

Section 6.14 No Authorship Presumption. Each of the Parties has had an opportunity to obtain legal advice and negotiate the language of this UMI CEA and the Project Agreements. No presumption shall arise, or adverse inference be drawn by virtue of authorship, and each Party hereby waives the benefit of any rule of law that might otherwise be applicable in connection with the interpretation of this UMI CEA or any Project Agreement, including to any rule of law to the effect that any provision of this UMI CEA shall be interpreted or construed against the Party whose counsel drafted that provision.

Section 6.15 No Third Party Benefit. No provisions in this UMI CEA are for the benefit of, or may be enforceable by, any person other than the Parties hereto and their permitted successors and assigns. Each Party hereto may only seek enforcement of its own rights hereunder, and no Party may seek enforcement (whether in its own name or on behalf of another Party) of the rights of another Party hereto.

Section 6.16 Counterparts. This UMI CEA may be executed in several counterparts, each which shall be an original and all of which when taken together shall be deemed one and the same agreement.

Section 6.17 Negotiations. For clarity, the Parties agree that CenTrio shall not, without the consent of TEP, negotiate with the University or UMLLC the terms of the BMS Project Agreement, and TEP shall not, without the consent of CenTrio, negotiate with the University or UMLLC the terms of the Prime Lease, Sublease or other Project Documents (other than the BMS Project Agreement).

[Remainder of Page Intentionally Blank; Signatures to Follow]

DRAFT

IN WITNESS WHEREOF, the Parties hereto have executed this UMI CEA effective as of the day and year first set forth above.

UNIVERSITY:

**LOUISIANA STATE UNIVERSITY AND
AGRICULTURAL AND MECHANICAL COLLEGE**

By: _____
Name:
Title:

UMLLC:

UTILITIES MODERNIZATION LLC

By: _____
Name:
Title:

CENTRIO:

[_____]

By: _____
Name:
Title:

TEP:

TIGER ENERGY PARTNERS, LLC

By: _____
Name:
Title:

EXHIBIT A

Thermal Assets

DRAFT

EXHIBIT B

Building Mechanical Systems

DRAFT

**LONG-TERM LEASE AND CONCESSION AGREEMENT FOR
LOUISIANA STATE UNIVERSITY UTILITY SYSTEM**

dated as of

[•]

by and between

**BOARD OF SUPERVISORS OF LOUISIANA STATE UNIVERSITY AND
AGRICULTURAL AND MECHANICAL COLLEGE**

and

UTILITIES MODERINZATION LLC

TABLE OF CONTENTS

(continued)

SCHEDULES

Schedule 1	Reserved
Schedule 2A	Performance Standards
Schedule 2B	Interim Performance Standards
Schedule 3A	Utility Facilities, Utility System Land and Utility System Assets
Schedule 3B	Building Mechanical Systems
Schedule 3C	Distribution System
Schedule 4A	University Utility System Employees
Schedule 4B	Form of Employee Services Agreement
Schedule 5	Utility Fee
Schedule 6	Existing Supply Contracts
Schedule 7	Preliminary Design
Schedule 8A	Form of Legal Opinion of Counsel to University
Schedule 8B	Form of Legal Opinion of Counsel to UMLLC
Schedule 9	Historical Financial Information
Schedule 10	Permitted University Encumbrances
Schedule 11	Excluded Utility System Projects
Schedule 12	Computer Systems and Software
Schedule 13	Form of Memorandum of Lease
Schedule 14	Reserved
Schedule 15	Key Performance Indicators
Schedule 16	University Campus Map
Schedule 17	Diversity Plan
Schedule 18	Campus-Wide Permits
Schedule 19	Reserved
Schedule 20	Form of Trademark License Agreement
Schedule 21	Notices to Proceed; Conditions to IMP Substantial Completion and IMP Final Acceptance of Initial Modernization Project
Schedule 22	Warranty Period Utility System Projects
Schedule 23	Concession Agreement

**LONG-TERM LEASE AND CONCESSION AGREEMENT FOR
LOUISIANA STATE UNIVERSITY UTILITY SYSTEM**

THIS LONG-TERM LEASE AND CONCESSION AGREEMENT FOR THE LOUISIANA STATE UNIVERSITY UTILITY SYSTEM (this “University Lease”) is made and entered into as of this [•] day of [•], 20[•]by and between the Board of Supervisors of Louisiana State University and Agricultural and Mechanical College, a public constitutional corporation organized and existing under the laws of the State of Louisiana (the “Board”) and Utilities Modernization LLC, a Louisiana limited liability company (“UMLLC”), the sole member of which is the LSU Real Estate and Facilities Foundation, a Louisiana nonprofit corporation (the “Foundation”).

RECITALS

WHEREAS, Louisiana State University and Agricultural and Mechanical College (“LSU”), is the flagship institution of the State of Louisiana under the management and supervision of the Board of Supervisors of Louisiana State University and Agricultural and Mechanical College (the “Board” and, together with LSU, the “University”), which Board is a public constitutional corporation organized and existing under the laws of the State of Louisiana; and

WHEREAS, the Foundation is a tax-exempt organization organized and operated for the purpose of supporting the University, its programs, facilities, and research and educational activities, the Foundation is the sole member of UMLLC, and the business of UMLLC is at all times carried out and operated exclusively for the tax-exempt purposes of the Foundation; and

WHEREAS, at the University’s flagship campus in Baton Rouge, Louisiana (the “University Campus”), the operating costs, deferred maintenance and replacement of its Utility System (defined herein) comprised of the Utility Facilities and the Utility System Assets (both, as defined herein) places a substantial financial burden on the University and the State of Louisiana and exposes the University, State of Louisiana, and Utility System to risks that materially and adversely impact the University’s ability to conduct its business and satisfy its commitments and obligations; and

WHEREAS, the University has identified a need to develop and implement a comprehensive modernization, operations and maintenance solution for the Utility System in order to mitigate these risks, eliminate unnecessary expenditures, increase efficiencies that derive savings, establish robust levels of service for operations and maintenance, increase future budget certainty for the University, address deferred maintenance challenges, address the University’s anticipated increase in energy demand, achieve operational efficiencies, and ensure resiliency of the Utility System (the “Utilities Modernization Initiative”); and

WHEREAS, in light of these goals, the University, together with its staff and advisors, has undertaken a comprehensive review and assessment of the Utility System and has developed a framework for achieving the Utilities Modernization Initiative with one or more private district energy services providers to make capital investments in and operate more efficiently the Utility System; and

WHEREAS, the University, UMLLC, [Baton Rouge Energy Concessionaire LLC, a [•] limited liability company (the “Concessionaire”), and Tiger Energy Partners, LLC, a limited liability company organized and existing under the laws of the State of Delaware and authorized to do business in the State of Louisiana (“TEP”), have entered into that certain Cooperative Endeavor Agreement (LSU Utilities Modernization Initiative), dated the date hereof (the “UMI CEA”), to memorialize the cooperative intent among the University, UMLLC, Concessionaire, and TEP to design, develop and implement improvements to the Utility System, and to establish generally the transaction framework for the implementation of the Utilities Modernization Initiative; and

WHEREAS, pursuant to Louisiana Revised Statutes 17:3361, *et seq.*, as amended from time to time (the “University Leasing Act”), the University is authorized to lease to a private entity, such as UMLLC, any portion or portions of the University Campus or other immovable property under its supervision and management under the conditions set forth therein; and

WHEREAS, the University Leasing Act further requires any such lease to a private entity to provide for the construction of improvements on the portion or portions of the University Campus subject to such lease that will further the educational, scientific, research, or public service functions of the University; and

WHEREAS, in furtherance of the foregoing, and pursuant to the UMI CEA, the University, UMLLC, the Concessionaire, and TEP are engaging in a public-private partnership for the performance of the Utilities Modernization Initiative, pursuant to which: (a) the University will lease the Utility System Land, Utility Facilities and Utility System Assets (collectively, the “Property”), as more particularly described in Schedule 3A attached hereto, together with certain construction, access, parking, and utility servitudes for the purpose of implementing the Utilities Modernization Initiative, as approved by the University, to UMLLC pursuant to this University Lease, (b) UMLLC and Concessionaire will enter into that certain Long-Term Sub-Lease and Concession Agreement for Louisiana State University Utility System dated the date hereof (the “Concession Agreement”) for the sublease of the Property and granting of the necessary construction, access, parking, and utility servitudes for the purpose of implementing the Utilities Modernization Initiative, and (c) and the Concessionaire will engage TEP, as design-build contractor, to perform certain design and construction obligations related to the Initial Modernization Project pursuant to a Drop-Down DB Contract, which Drop-Down DB Contract has been approved by the University and UMLLC; and

WHEREAS, the University has determined that the lease of the Property to UMLLC under this University Lease and the engagement by UMLLC of the Concessionaire under the Concession Agreement will, among other things, further the University’s energy efficiency and sustainability goals, provide a mechanism for capital improvements as needed, permit the more efficient operation of the Utility System, and advance the overall educational purposes of the University and UMLLC, and, therefore, the University desires to lease the Property to UMLLC and approve the sublease of the Property from UMLLC to Concessionaire pursuant to the terms and conditions of this University Lease and the Concession Agreement, including but not limited to providing the Concessionaire with an exclusive right to design, build, and finance the Initial Modernization Project and other Capital Improvements, and to operate, maintain, possess, control and improve the Utility System for the Term of this University Lease, all as hereinafter provided; and

WHEREAS, UMLLC agrees to lease the Property from the University and sublease the Property to the Concessionaire pursuant to the Concession Agreement, which Concession Agreement will provide Concessionaire with the exclusive grant to design, build, and finance the Initial Modernization Project and other Capital Improvements and to operate, maintain, possess, control, and improve the Utility System for the Term of this University Lease, all as hereinafter provided; and

WHEREAS, UMLLC agrees that the Concession Agreement shall require the Concessionaire to sublease the Property from UMLLC and to operate, maintain, possess, control and improve the Utility System in accordance with the provisions this University Lease, including the Performance Standards (as defined herein); and

WHEREAS, UMLLC agrees that the Concession Agreement shall require the Concessionaire to design, build, and finance the Initial Modernization Project and other Capital Improvements, as hereinafter provided; and

WHEREAS, UMLLC agrees that the Concession Agreement shall require the Concessionaire to provide the Utility Services (as defined herein) to UMLLC and to engage in the Utility System Operations (as defined herein) pursuant to the terms and conditions of this University Lease;

NOW THEREFORE, for and in consideration of the promises, the mutual covenants, representations, warranties and agreements contained herein and other valuable consideration, the receipt and sufficiency of which are hereby acknowledged, the Parties (as defined herein) covenant and agree as follows:

ARTICLE 1 DEFINITIONS AND INTERPRETATION

Section 1.1. Definitions. Unless otherwise specified or the context otherwise requires, for the purposes of this University Lease the following terms have the following meanings:

“AA-Compensation” has the meaning ascribed thereto in Section 14.1(b).

“AA-Dispute Notice” has the meaning ascribed thereto in Section 14.1(c).

“AA-Notice” has the meaning ascribed thereto in Section 14.1(c).

“AA-Preliminary Notice” has the meaning ascribed thereto in Section 14.1(c).

“AAA” means the American Arbitration Association.

“Abandon” means to abandon all or a material part of the Initial Modernization Project, which abandonment will be deemed to have occurred if: (a) UMLLC demonstrates through statements, acts, or omissions an intent not to continue (for any reason other than a Delay Event that interferes with UMLLC’s ability to continue) to design or construct the Initial Modernization Project; (b) no significant Construction Work (taking into account any Delay Event) on the Initial Modernization Project is performed for a continuous period of more than sixty (60) days; or (c)

UMLLC fails to begin (taking into account any Delay Event) (i) any works or activities authorized pursuant to NTP1, within thirty (30) days following the issuance of NTP1, (ii) any works or activities authorized pursuant to NTP2, within thirty (30) days following the issuance of NTP2, or (iii) any works or activities authorized pursuant to NTP3, within thirty (30) days following the issuance of NTP3, in the case of each of clause (a), clause (b) and clause (c), unless such failure is otherwise expressly permitted or excused pursuant to this University Lease.

“Actual Knowledge of the University” means the actual, current knowledge of the University’s [Note: Designated Officer(s) of the University to be named] on any date which a relevant representation or warranty is made, with the duty for each of the foregoing to inquire of his or her direct reports within five (5) Business Days prior to the date of such representation or warranty regarding the relevant matter, but without any other duty of inquiry or investigation.

“Actual Knowledge of UMLLC” means the actual, current knowledge of [Note: Designated Officer(s) of the University to be named] on any date which a relevant representation or warranty is made, with the duty for each of the foregoing to inquire of his or her direct reports within five (5) Business Days prior to the date of such representation or warranty regarding the relevant matter, but without any other duty of inquiry or investigation.

“Additional Coverages” has the meaning ascribed thereto in Section 13.3(l).

“Adjusted for Inflation” means adjusted by the arithmetic average of the percentage increases, if any, or decreases, if any, in the CPI Index during the most recent adjustment period as specified herein.

“Adverse Action” has the meaning ascribed thereto in Section 14.1(a).

“Affiliate”, when used to indicate a relationship with a specified Person, means:

- (a) a Person that, directly or indirectly, through one or more intermediaries (i) has a fifty percent (50%) or more voting or economic interest in such specified Person or (ii) is Controlled by such specified Person;
- (b) with respect to any Person described in clause (a), such Person’s Ultimate Holding Entity and any entity that such Ultimate Holding Entity (i) has a fifty percent (50%) or more voting or economic interest in or (ii) Controls;
- (c) any Person that is managed by either such Person described in clause (b) or a related body corporate of such Person for so long as such other Person is so managed;
- (d) any trustee of a trust in which all or substantially all of the beneficial interests are held directly or indirectly by such Person or any Person referred to in clauses (a), (b), or (c) of this definition; or
- (e) any trustee, custodian, or nominee of such Person or any Person referred to in clauses (a), (b), (c), or (d) of this definition;

provided that a Person shall be deemed to be controlled by another Person if controlled in any manner whatsoever that results in control in fact by that other Person (or that other Person and any Person or Persons with whom that other Person is acting jointly or in concert), whether directly or indirectly and whether through share ownership, a trust, a contract, or otherwise (for purposes of this definition, a managed fund or trust shall be deemed to be an Affiliate of the Person managing, supervising, sponsoring, or advising such fund or trust and a limited partner in a managed fund or trust shall be deemed to be an Affiliate of such fund or trust and of the Person managing, supervising, sponsoring, or advising such fund or trust).

“Approved Five-Year Plan” means the Five-Year Plan then in effect pursuant to Section 7.2.

“Approval”, “Approved”, “Approves”, “Approved by the University” and similar expressions mean approved or consented to by the University in accordance with the provisions of Section 1.15.

“Assignment and Assumption Agreement” has the meaning ascribed thereto in Section 19.8(c).

“Assumed Liabilities” has the meaning ascribed thereto in Section 3.2(d).

“Audit and Review” and similar expressions mean, with respect to any matter or thing relating to the D&C Work, the Utility System, the Utility System Operations or this University Lease, the performance by or on behalf of the University of such reviews, investigations, inspections and audits relating to such matter or thing as the University may reasonably determine to be necessary in the circumstances, conducted in each case in accordance with Prudent Industry Practices, if any, or as required by Law, and in accordance with the provisions of this University Lease.

“Authorization” means any approval, certificate of approval, certification, authorization, consent, waiver, variance, exemption, declaratory order, exception, license, filing, registration, permit, franchise, notarization or other requirement of any Person that applies to the Utility System or is reasonably required from time to time for the Utility System Operations, including any of the foregoing issued, granted, given or otherwise made available by or under the authority of any Governmental Authority or pursuant to any applicable Law.

“Bank Rate” means three (3)-month LIBOR (or any successor rate thereto) as reported in the *Wall Street Journal* (or any successor thereof).

“Board” has the meaning ascribed thereto in the recitals of this University Lease.

“Breakage Costs” means any breakage costs, make-whole premium payments, termination payments, or other prepayment amounts (including debt premiums and interest rate hedge termination costs) that are required to be paid by UMLLC with respect to Leasehold Mortgage Debt as a result of the early repayment (including, following acceleration) of such Leasehold Mortgage Debt prior to its scheduled maturity date.

“Building Mechanical Systems” means those “in-building” portions of the Utility Facilities more particularly described in Schedule 3B.

“Business Day” means any Day that is neither a Saturday, a Sunday, nor a Day observed as a holiday by the University; provided, that solely with respect to the timing of any payment obligation under this University Lease, a Business Day shall also not be a Day on which banks that are members of the United States federal reserve system are permitted or required to be closed.

“Campus-Wide Permits” means the Authorizations set forth on Schedule 18, as each may be extended, renewed, modified or replaced.

“Capital Improvement” means any improvement to or replacement or expansion of the components of the Utility Facilities or Shared Spaces that is capital in nature, as determined in accordance with GAAP. For clarity, the Initial Modernization Project constitutes a Capital Improvement.

“Capital Recovery Amount” has the meaning ascribed thereto in Schedule 5.

“Capped O&M Amount” has the meaning ascribed thereto in Schedule 5.

“Casualty Cost” has the meaning ascribed thereto in Section 13.4(a)(ii).

“CenTrio” means [•].

“Certificate of IMP Final Acceptance” has the meaning ascribed thereto in Section 22.1(g).

“Certificate of IMP Substantial Completion” has the meaning ascribed thereto in Section 22.2(e).

“Change in Control” means, with respect to any Person, whether accomplished through a single transaction or a series of related or unrelated transactions and whether accomplished directly or indirectly, any of (i) a change in ownership so that fifty percent (50%) or more of the direct or indirect voting or economic interests in such Person is transferred to a Person or group of Persons acting in concert, (ii) a change in the power directly or indirectly to direct or cause the direction of management and policy of such Person, whether through ownership of voting securities, by contract, management agreement, or common directors, officers or trustees or otherwise, is transferred to a Person or group of Persons acting in concert or (iii) the merger, consolidation, amalgamation, business combination, or sale of substantially all of the assets of such Person; provided, however, that notwithstanding anything to the contrary set forth in this definition, a “Change in Control” of UMLLC shall be deemed to have occurred at any time when the Foundation shall cease to own one hundred percent (100%) of the ownership of UMLLC (or otherwise possess less than all of the power to direct or cause the direction of the management of UMLLC).

“CI Cost of Debt Factor” has the meaning ascribed thereto in Schedule 5.

“CI Return on Equity Factor” has the meaning ascribed thereto in Schedule 5.

“City-Parish” means the City of Baton Rouge and Parish of East Baton Rouge, State of Louisiana.

“Claim” means any demand, action, cause of action, suit, proceeding, arbitration, claim, judgment, or settlement or compromise relating thereto which may give rise to a right to a payment obligation under Section 12.1 or Section 12.2.

“Code” means the Internal Revenue Code of 1986, as amended from time to time. Any reference in this University Lease to a particular provision of the Code shall be interpreted to include a reference to any corresponding provision of any successor statutes.

“Cogeneration Building” means the “Cogeneration Building” as described or depicted Schedule 3A.

“Comparable Utility Systems” means with respect to any component of the Utility System, a utility system producing and/or delivering any of the Utilities (whether privately or publicly owned) that is located at a large university, is used in connection with providing such utility services to such university, its employees, customers, and visitors and is reasonably comparable to the relevant component of the Utility System in terms of physical structure, capacity, condition, utilization, and the nature of the services provided, provided that the University and UMLLC may designate by written agreement one or more utility systems as “Comparable Utility Systems”.

“Compensation Calculation Date” means each of the following: (i) each June 30 during the Term, commencing as of June 30, 202[●]; (ii) the date of removal of the Operator pursuant to Section 3.3(c)(ii); (iii) the first (1st) June 30 after any date on which one Party notifies the other Party that it, in good faith, believes that the Concession and KPI Compensation Balance would exceed [two hundred fifty thousand dollars (\$250,000)] if calculated on the date of such notice; and (iv) the End Date.

“Compensation Calculation Measuring Period” means (i) with respect to the first (1st) Compensation Calculation Date, the period commencing on the Turnover Date and expiring on such Compensation Calculation Date, and (ii) with respect to each subsequent Compensation Calculation Date, the period between such Compensation Calculation Date and the immediately preceding Compensation Calculation Date.

“Compensation Event” means each of the following: (i) subject to Article 5, UMLLC’s compliance with or the implementation of any University Directive or any modified or changed Performance Standard, subject to Section 6.3(b); *provided* that it shall not be a Compensation Event if the costs or reduction in revenue incurred in connection therewith will be recovered by UMLLC pursuant to the calculation and payment of the Utility Fee; (ii) the occurrence of an Adverse Action; (iii) the occurrence of an event causing a delay described in the definition of “Delay Event” but only to the extent that the Utility Fee is reduced by a Delay Event caused by such event pursuant to Section 15.1(c); (iv) the occurrence of an event expressly described as a Compensation Event in Section 3.7(a); (v) the University distributing or permitting any third party to distribute on the University Campus, any Utility, except as permitted by Section 3.21; (vi) UMLLC incurring any Losses as a result of failing to obtain, or being unreasonably delayed in obtaining, or failing to promptly renew or maintain in good standing, an Authorization from the

University that is necessary to comply with Law, despite UMLLC's use of its reasonable best efforts to obtain, promptly renew, or maintain in good standing such Authorization, and such failure or delay could not have been reasonably prevented by commercially reasonable technical, scheduling, or other measures of UMLLC; (vii) any suspension of the Construction Work that constitutes a Compensation Event pursuant to Section 21.4(b); (viii) any action of the Louisiana Public Service Commission or the Federal Energy Regulatory Commission, or their respective successors, that subjects UMLLC to such agency's regulatory jurisdiction due solely to the Utility System Operations performed by UMLLC in accordance with this University Lease and has a material adverse effect on the fair market value of the UMLLC Interest (whether as a result of a decrease in the Utility Fee or other revenues or increased expenses that cannot be recovered pursuant to this University Lease or both), except where such action is in response to any act or omission on the part of UMLLC that is illegal (other than an act or omission rendered illegal by virtue of the agency's action) or such action is otherwise permitted under this University Lease and such designation as a Compensation Event shall be UMLLC's sole right and remedy with respect to any action by the Louisiana Public Service Commission or the Federal Energy Regulatory Commission (or their successors) subjecting a Person to its jurisdiction in connection with the Utility System; (ix) the occurrence of a change described in clause (iii) of Section 6.1(a) to the extent that notice of such change was not publically available or otherwise known by CenTrio prior to the date hereof; or (x) the occurrence of any other event that under the terms of this University Lease expressly requires the payment of Concession Compensation.

"Concession Agreement" has the meaning ascribed thereto in the recitals of this University Lease, which Concession Agreement is substantially in the form attached hereto as Schedule 23.

"Concession Compensation" means any amount payable by the University to UMLLC in order to restore UMLLC to the same economic position UMLLC would have enjoyed if the applicable Compensation Event had not occurred, which amount, for any Compensation Calculation Date, shall be calculated as the sum of (i) all Losses for the applicable Compensation Calculation Measuring Period and financing costs (but excluding any costs and expenses that UMLLC is able to recover through the payment of the Utility Fee) plus (ii) the actual and estimated net losses of the Utility Fee for the applicable Compensation Calculation Measuring Period that is reasonably attributable to such Compensation Event; provided, however, that with respect to clause (ii), the amount of such actual and estimated net losses that may be claimed at any Compensation Calculation Date shall not exceed the amount of actual and estimated net losses of the Utility Fee suffered during, and attributable only to, such Compensation Calculation Measuring Period (including the inability to make Capital Improvements that the University had Approved); provided, further, that with respect to clause (ii), the amount of such actual and estimated net losses reasonably attributable to such Compensation Event and suffered during, and attributable only to, a future Compensation Calculation Measuring Period may be claimed as Concession Compensation for such future Compensation Calculation Measuring Period only during such future Compensation Calculation Measuring Period in accordance with Article 15. Concession Compensation, if any, shall be paid in accordance with Article 15 and shall not be subject to any limitations on the amount of the Utility Fee. If UMLLC provides its own capital for a Capital Improvement with respect to compliance with any Compensation Event that is not recoverable by UMLLC pursuant to the Utility Fee, then the Concession Compensation, shall, in addition to the components described above, take into account a return on such capital equal to the IMP Return on Equity Factor or the CI Return on Equity Factor, as the case may be.

“Concession and KPI Compensation Balance” means, at each Compensation Calculation Date, (i) Concession Compensation due and payable with respect to such Compensation Calculation Measuring Period pursuant to the terms of this University Lease less (ii) the sum of all KPI Compensation due and payable with respect to such Compensation Calculation Measuring Period pursuant to the terms of this University Lease, plus (iii) the Concession and KPI Compensation Balance (which may be negative) for the preceding Compensation Calculation Measuring Period if carried forward pursuant to Section 15.3(e).

“Concessionaire” has the meaning ascribed thereto in the recitals to this Agreement.

“Concessionaire Cost of Finance” means an amount equal to eight hundred forty thousand dollars (\$840,000) from the gross amount of the financing of the Initial Modernization Project.

“Consent” means any approval, consent, ratification, waiver, exemption, franchise, license, permit, novation, certificate of occupancy, or other authorization of any Person, including any Consent issued, granted, given, or otherwise made available by or under the authority of any Governmental Authority or pursuant to any applicable Law.

“Contractor” means, with respect to a Person, any contractor with whom such Person contracts to perform work or supply materials or labor in relation to the Utility System, including any subcontractor of any tier, supplier, or materialman directly or indirectly employed pursuant to a subcontract with a Contractor. For the avoidance of doubt, (a) the Concessionaire shall be a Contractor of UMLLC and (B) each of the Operator and the IMP Contractor shall be a Contractor of UMLLC for purposes of this University Lease (regardless of whether the Operator or IMP Contractor, as applicable, is engaged by the Concessionaire pursuant to the Concession Agreement).

“Construction Documents” means all shop drawings, working drawings, fabrication plans, material and hardware descriptions, specifications, construction quality control reports, and construction quality assurance reports and samples necessary or desirable for construction of the Initial Modernization Project in accordance with this University Lease.

“Construction Work” means all work to build or construct, make, form, manufacture, furnish, install, supply, deliver, or equip the Initial Modernization Project.

“Control” means, when used with respect to any particular Person, the possession, directly or indirectly, of the power to direct or cause the direction of the management and policies of such Person whether through the ownership of voting securities or partnership or other ownership interests, by contract or otherwise, and the terms “Controlling,” “Controlled by” and “under common Control with” have meanings correlative to the foregoing. With respect to a managed fund or trust, Control includes the right to direct or cause the direction of the management and policies of such managed fund or trust as manager, advisor, supervisor, sponsor, or trustee pursuant to relevant contractual arrangements.

“CPI Index” means the “Consumer Price Index – South Urban, All Items” (not seasonally adjusted) as published by the U.S. Department of Labor, Bureau of Labor Statistics; provided, however, that if the CPI Index is changed so that the base year of the CPI Index changes, the CPI Index shall be converted in accordance with the conversion factor published by the U.S.

Department of Labor, Bureau of Labor Statistics; provided further, that if the CPI Index is discontinued or revised during the Term, such other index or computation with which it is replaced shall be used in order to obtain substantially the same result as would be obtained if the CPI Index had not been discontinued or revised.

“Credit Rating Agencies” means Standard & Poor’s Rating Services, Fitch Investors Service, Inc., or Moody’s Investor Services, or their successors or Affiliates, provided that if any of the foregoing and any of their successors cease to exist, the University shall, by written notice to UMLLC, identify other credit rating agencies as the “Credit Rating Agencies” that, at such time, are Nationally Recognized Statistical Rating Organizations as determined and defined by the United States Securities and Exchange Commission or their equivalents.

“D&C Closeout Plan” has the meaning ascribed thereto in Section 22.2(b).

“D&C Security” means, collectively, (i) the Performance Bond and (ii) the Payment Bond.

“D&C Work” means all design, engineering, and construction-related services, including the Construction Work, necessary in order to design, implement, and deliver the Initial Modernization Solution in accordance with the approved Final Design and the terms and conditions of this University Lease, including Article 22 and Article 23.

“Day” means a calendar day, beginning at midnight in the central time zone of the United States coinciding with the calendar day.

“Defending Party” has the meaning ascribed thereto in Section 12.4(c).

“Delay Event” means: (i) an event of Force Majeure that interrupts, limits, or otherwise adversely affects the performance of UMLLC’s obligations hereunder or UMLLC’s use of all or any material part of the Utility System; (ii) a failure to obtain, or delay in obtaining, any Authorization from a Governmental Authority (provided that such failure or delay could not have been reasonably prevented by technical and scheduling measures or other reasonable measures of UMLLC); (iii) the enactment of a new Law or the modification, amendment, or change in enforcement or interpretation of a Law (including a change in the application or implementation thereof by any Governmental Authority) arising after the Turnover Date; (iv) a delay caused by the performance of works (including the activities authorized by Section 3.7) carried out by the University or at its direction or, for purposes of Delay Events only (and not Compensation Events), by any other Person not acting under the authority or direction of UMLLC or any Contractor; (v) a delay caused by a failure by the University to perform or observe any of its covenants or obligations under this University Lease; (vi) a delay caused by the presence in, on, under, over, or around the Utility System of Hazardous Substances, which, in each case, results in or would result in a delay or interruption in the performance by UMLLC of any obligation under this University Lease and which Hazardous Substances were not caused to be in, on, under, over, or around the Utility System by UMLLC, any Contractor, or any of their respective Representatives; (vii) a delay in providing the Utility Services caused by the failure of a third party or the University to provide any of the inputs into the Utility System that would be included in the definition of “Supplies”; (viii) subject to Section 9.4(a), a delay caused by a breach by the University of its representations and warranties set forth herein; (ix) a writ, decree, or injunction that precludes or prevents the

performance of UMLLC's obligations hereunder or UMLLC's use of all or any material part of the Utility System; (x) the discovery at or about the site of construction required or permitted to be undertaken pursuant to this University Lease of legally protected plant or animal species or archaeological, paleontological, or cultural resources; or (xi) the occurrence of any event expressly described as a Compensation Event in clause (i), clause (vii), or clause (viii) of the definition of "Compensation Event." For the avoidance of doubt, a Delay Event shall not include any event of which the consequence is otherwise specifically dealt with in this University Lease or arises by reason of (A) the negligence or willful misconduct of, or violation of applicable Law by, UMLLC, any Contractor, or any of their respective Representatives, (B) any act or omission by UMLLC or its Representatives in breach of the provisions of this University Lease, (C) any strike, labor dispute, or other labor protest involving any Person retained, employed, or hired by UMLLC or its Representatives to supply materials or services for or in connection with the Utility System Operations or any strike, labor dispute, or labor protest pertaining to UMLLC, in all cases to the extent that such strike, dispute, or protest (1) is not of general application and (2) is caused by or attributable to any act (including any pricing or other practice or method of operation) or omission of UMLLC or its Representatives, or (D) lack or insufficiency of funds or failure to make payment of monies or provide required security on the part of UMLLC, unless such lack or insufficiency of funds or such failure is caused by another relevant Delay Event.

"Delay Event Remedy" has the meaning ascribed thereto in Section 15.1(d).

"Delay Event Remedy Dispute Notice" has the meaning ascribed thereto in Section 15.1(e).

"Delay Event Remedy Notice" has the meaning ascribed thereto in Section 15.1(e).

"Depository" means a savings bank, a savings and loan association, or a commercial bank or trust company which would qualify as an Institutional Lender, designated by UMLLC, that enters into an agreement with UMLLC to serve as depository pursuant to this University Lease, provided that such Depository shall have an office, branch, agency, or representative located in the City of Baton Rouge, Louisiana (or in another location within the United States designated by the University in writing, acting reasonably); *provided, however*, that so long as a Leasehold Mortgage is in effect, the Depository under Section 13.4 shall be the institution acting as the collateral agent or depository under the financing secured by such Leasehold Mortgage, whether or not it has an office, branch, agency, or representative located in the City of Baton Rouge, Louisiana (or such other location within the United States designated by the University in writing, acting reasonably).

"DEQ" has the meaning ascribed thereto in Section 11.13.

"Designated Senior Person" means such individual or individuals who are designated as such from time to time by each Party for the purposes of Article 18 by written notice to the other Party, which may be changed at any time by written notice from such Party to the other Party. Initially, the Designated Senior Person for the University will be the University's [•] and the Designated Senior Persons for UMLLC will be [•] and [•].

"Direct Claim" means any Claim by an Obligee against an Obligor that does not result from a Third Party Claim.

“Disclosure Schedules” means the following Schedules: Schedule 3A, Schedule 3B, Schedule 6, Schedule 9, Schedule 10, Schedule 11, Schedule 12, Schedule 14, Schedule 16, Schedule 18, and Schedule 22.

“Dispute Notice” has the meaning ascribed thereto in Section 15.3(b).

“Distribution Bottlenecks” means those portions of the Distribution System described on Schedule 3C which are subject to the Initial Modernization Project as described on Schedule 7 and which portions, for purposes of this Agreement, (i) shall be deemed a part of the Utility System (and not part of the Distribution System) until the IMP Substantial Completion Date, and (ii) shall be deemed a part of the Distribution System (and not part of the Utility System, unless and until the same becomes subject to a Distribution System Capital Improvement) from and after the IMP Substantial Completion Date.

“Distribution System” means the respective equipment, systems and facilities (including any discrete component portion thereof) for the carriage and distribution of each Utility that are, as of the Turnover Date, beyond the line of demarcation for inclusion in the Utility Facilities and Utility System, all as described and shown on Exhibit 3C.

“Distribution System Capital Improvement” means any improvement to or replacement or expansion of the components of the Distribution System that is capital in nature, as determined in accordance with GAAP.

“Diverse Business” has the meaning ascribed thereto in Section 11.11.

“Diversity Plan” means the Diversity, Inclusion and Equity Plan attached hereto as Schedule 17.

“Document” has the meaning ascribed thereto in Section 1.15(j).

“Drop-Down DB Contract” means that certain [•] dated as of the date hereof by and between the Concessionaire and the IMP Contractor, providing for the design, construction, and completion of the Initial Modernization Project.

“Eligible Investments” means any one or more of the following obligations or securities: (i) direct obligations of, and obligations fully guaranteed by, the United States of America or any agency or instrumentality of the United States of America, the obligations of which are backed by the full faith and credit of the United States of America; (ii) demand or time deposits, federal funds or bankers’ acceptances issued by any Institutional Lender (provided that the commercial paper or the short-term deposit rating or the long-term unsecured debt obligations or deposits of such Institutional Lender at the time of such investment or contractual commitment providing for such investment have been rated “A” (or the equivalent) or higher by a Credit Rating Agency or any other demand or time deposit or certificate of deposit fully insured by the Federal Deposit Insurance Corporation); (iii) commercial paper (including both non-interest-bearing discount obligations and interest-bearing obligations payable on demand or on a specified date not more than one (1) Year after the date of issuance thereof) which has been rated “A” (or the equivalent) or higher by a Credit Rating Agency at the time of such investment; (iv) any money market funds, the investments of which consist of cash and obligations fully guaranteed by the United States of

America or any agency or instrumentality of the United States of America, the obligations of which are backed by the full faith and credit of the United States of America and which have been rated “A” (or the equivalent) or higher by a Credit Rating Agency; and (v) other investments then customarily accepted by the University in similar circumstances; *provided, however*, that no instrument or security shall be an Eligible Investment if such instrument or security evidences a right to receive only interest payments with respect to the obligations underlying such instrument or if such instrument or security provides for payment of both principal and interest with a yield to maturity in excess of one hundred twenty percent (120%) of the yield to maturity at par.

“Emergency” means (i) an Unplanned Outage or (ii) a situation that is urgent and calls for immediate action, which, if such action is not taken, is reasonably likely to result in imminent harm or physical damage to any or all of the Utility System or any Person, including the University or UMLLC.

“Employee Services Agreement” means the agreement set forth in the form of Schedule 4B.

“Encumbrance” means any mortgage, lien, judgment, execution, pledge, charge, security interest, restriction, easement, servitude, option, reservation, lease, claim, trust, deemed trust, or encumbrance of any nature whatsoever, whether arising by operation of Law, judicial process, contract, agreement, or otherwise created.

“End Date” means the date on which this University Lease expires or is terminated.

“Environment” means soil, surface waters, ground waters, land, stream sediments, surface or subsurface strata, and ambient air.

“Environmental Laws” means any Laws applicable to the Utility System or Utility System Operations regulating or imposing liability or standards of conduct concerning or relating to (i) the regulation, use, or protection of human health or the Environment or (ii) the presence of or regulation, use, or exposure to Hazardous Substances.

“Equity Participant” means any Person who holds directly any shares of capital stock, units, partnership or membership interests, other equity interests, or equity securities of UMLLC.

“Equivalent Project Relief” has the meaning ascribed thereto in Section 1.21.

“Excluded Liabilities” has the meaning ascribed thereto in Section 3.2(d).

“Excluded Utility System Projects” means (a) those projects that the University is undertaking with respect to the Utility System that are listed on Schedule 11 and (b) those Capital Improvements that the University undertakes after the Turnover Date pursuant to its right to undertake such improvements under Section 3.21 or Section 4.1(b).

“Extraordinary Failure” means the failure (but only if such failure occurs prior to the Planned IMP Substantial Completion Date) of equipment or systems associated with the Utility System not addressed by the Initial Modernization Project reasonably attributable to the University’s deferred maintenance of the Utility System accumulated as of the Turnover Date,

including end-of-life breakdown repairs, replacements and rentals of temporary replacement equipment.

“FA Punch List” means the itemized list of Construction Work that remains to be completed as a condition to IMP Final Acceptance, prepared by UMLLC and included in the D&C Closeout Plan and agreed with the University prior to IMP Substantial Completion in accordance with Section 21.1. The FA Punch List shall only include any incomplete Construction Work that, due to its nature and the activities required to correct and complete the work, will not have any material or adverse effect on the normal, uninterrupted, and safe use of the Initial Modernization Project.

“Final Design” shall mean the full and complete design for the Initial Modernization Project, based on the Preliminary Design and approved by the University, for the final design and construction of one hundred percent (100%) of the Initial Modernization Project pursuant to the Drop-Down DB Contract.

“Fiscal Year” means the period from July 1 to June 30, provided that the Fiscal Year shall always be the same as the University’s fiscal year.

“Five-Year Plan” means the budget and plan prepared by UMLLC in accordance with Section 7.2 for the operation of the Utility System and performance of its obligations under this University Lease in respect of (i) the period consisting of the first partial Fiscal Year of the Term and the first five (5) full Fiscal Years of the Term, (ii) any given period of exactly five (5) full Fiscal Years during the Term, or (iii) if fewer than five (5) full Fiscal Years remain in the Term, the remaining full and partial Fiscal Years of the Term.

“Force Majeure” means any event beyond the reasonable control of a Party that delays, interrupts, or limits the performance of the affected Party’s obligations hereunder, including an intervening act of God or public enemy, war, invasion, armed conflict, act of foreign enemy, blockade, revolution, act of terror, sabotage, civil commotions, interference by civil or military authorities, condemnation or confiscation of property or equipment by any Governmental Authority, nuclear or other explosion, radioactive or chemical contamination or ionizing radiation, fire, tornado, flooding, earthquake or other natural disaster, riot or other public disorder, vandalism, epidemic, quarantine restriction, strike, labor dispute or other labor protest, stop-work order or injunction issued by a Governmental Authority, a governmental embargo, or general unavailability or interruption of supplies or products for the construction, operation, maintenance, repair, replacement, and renovation of the Utility System.

“Forecast Utility Fee” has the meaning ascribed thereto in Section 7.1(a).

“Foreign Shell Bank” means a foreign bank that does not have a physical presence in any country and that is not affiliated with a bank that has a physical presence and an acceptable level of regulation and supervision.

“Foundation” has the meaning ascribed thereto in the preamble to this University Lease.

“GAAP” means U.S. generally accepted accounting principles, consistently applied.

“Governmental Authority” means any court, federal, state, local, or foreign government, department, commission, board, bureau, agency, or other regulatory, administrative, governmental, or quasi-governmental authority, which shall not include the University or UMLLC.

“Hazardous Substance” means any solid, liquid, gas, odor, heat, sound, vibration, radiation, or other substance or emission which is a contaminant, pollutant, dangerous substance, toxic substance, hazardous waste, subject waste, hazardous material, or hazardous substance that is or becomes regulated by applicable Environmental Laws or which is classified as hazardous or toxic under applicable Environmental Laws (including gasoline, diesel fuel or other petroleum hydrocarbons, polychlorinated biphenyls, asbestos, lead-based paint, and urea formaldehyde foam insulation).

“Highland Utility Center” means the “Highland Utility Center” as described or depicted Schedule 3A.

“IFRS” means the International Financial Reporting Standards, consistently applied.

“IMP Contractor” means, initially, TEP and, thereafter, any successor to TEP designated by UMLLC as the IMP Contractor pursuant Section 21.5.

“IMP Cost of Debt Factor” has the meaning ascribed thereto in Schedule 5.

“IMP Design Documents” means all drawings (including plans, profiles, cross-sections, notes, elevations, details, and diagrams), specifications, reports, studies, calculations, electronic files, records, and submittals necessary for, or related to, the design of the Initial Modernization Project. IMP Design Documents includes the Record Design Documents.

“IMP Final Acceptance” means the occurrence of all the events and satisfaction of all the conditions set out in Schedule 21, Part [C], as and when confirmed by the University’s issuance of a certificate in accordance with the procedures and within the time frame set out in Section 22.2.

“IMP Final Acceptance Date” means the date upon which the University issues the Certificate of IMP Final Acceptance.

“IMP Final Acceptance Deadline” means the day that is [sixty (60)] Days after the IMP Substantial Completion Date.

“IMP Final Acceptance Long Stop Date” means the day that is three hundred sixty-five (365) days after the IMP Substantial Completion Date, as such period may be extended in accordance with Section 15.1(c).

“IMP Return on Equity Factor” has the meaning ascribed thereto in Schedule 5.

“IMP Substantial Completion” means (a) the satisfaction of all the conditions set out in Schedule 21, Part [B] and (b) issuance by the University of the Certificate of IMP Substantial Completion in accordance Section 21.1.

“IMP Substantial Completion Date” means the date upon which the University issues the Certificate of IMP Substantial Completion.

“IMP Substantial Completion Long Stop Date” means the day that is three hundred sixty-five (365) days after the Planned IMP Substantial Completion Date, as such period may be extended in accordance Section 15.1(c).

“Initial Five-Year Plan” means the Five-Year Plan in respect of the period set forth in clause (i) of the definition of “Five-Year Plan”.

“Initial Investor” means UMLLC Parent or, if there is no UMLLC Parent as of the date hereof, each Equity Participant as of the date hereof.

“Initial Modernization Project” means the initial improvements and upgrades to the Utility System contemplated by the Preliminary Design and to be implemented and delivered by UMLLC in accordance with the Final Design and the terms and conditions set forth in this University Lease.

“Institutional Lender” means: (i) the United States of America, any state thereof, or any agency or instrumentality of either of them, any municipal agency, public benefit corporation or public authority, advancing or insuring mortgage loans or making payments which, in any manner, assist in the financing, development, operation, and maintenance of projects; (ii) any (a) savings bank, savings and loan association, commercial bank, trust company (whether acting individually or in a fiduciary capacity), or insurance company organized and existing under the laws of the United States of America or any state thereof, (b) foreign insurance company or commercial bank qualified to do business as an insurer or commercial bank as applicable under the laws of the United States of America, (c) pension fund, foundation or university or college or other endowment fund or (d) investment bank, pension advisory firm, mutual fund, investment company, or money management firm; (iii) any “qualified institutional buyer” under Rule 144(A) under the Securities Act or any other similar Law hereinafter enacted that defines a similar category of investors by substantially similar terms; or (iv) any other financial institution or entity designated by UMLLC and Approved by the University (provided that such institution or entity, in its activity under this University Lease, shall be acceptable under then-current guidelines and practices of the University); *provided, however*, that each such entity (other than entities described in clause (iii) of this definition) or combination of such entities if the Institutional Lender shall be a combination of such entities shall have individual or combined assets, as the case may be, of not less than five hundred million dollars (\$500,000,000), which shall include, in the case of an investment or advisory firm, assets controlled by it or under management.

“Interim Performance Standards” means the standards, specifications, policies, procedures, and processes that apply to the operation of, maintenance of, rehabilitation of the Utility System set forth in Schedule 2B and the appendices thereto (as may be modified pursuant to the terms hereof) from Turnover until the IMP Substantial Completion of the Initial Modernization Project. To the extent that any term or provision set forth in Schedule 2B or incorporated by reference in Schedule 2B conflicts with any term or provision specified in this University Lease, then such term or provision of this University Lease shall govern and shall supersede any such conflicting term or provision.

“Key Performance Indicators” means those requirements and standards for the operation of the Utility System as set forth on Schedule 15.

“KPI Compensation” means the amount of compensation due from UMLLC to the University for a KPI Event, which amount for each KPI Event is set forth in Schedule 15.

“KPI Event” has the meaning set forth in Schedule 15, unless such KPI Event is due to a Delay Event, a Compensation Event, a breach of this University Lease by the University, the negligence or willful misconduct of the University or its Representatives, grantees, tenants, contractors, mortgagees, licensees, concessionaires, and others claiming by, through, or under the University, or otherwise excused pursuant to this University Lease.

“Law” means any order, writ, injunction, decree, judgment, law, ordinance, decision, opinion, ruling, policy, statute, code, rule, or regulation of any Governmental Authority.

“Leasehold Mortgage” means any lease, indenture, mortgage, deed of trust, pledge, or other security agreement or arrangement, including a securitization transaction with respect to the Utility Fee or any part thereof, encumbering any or all of the UMLLC Interest or the shares or equity interests in the capital of UMLLC and any of its subsidiaries or any cash reserves or deposits held in the name of UMLLC, in each case that satisfies all of the conditions set forth in Section 3.6 and Section 19.1.

“Leasehold Mortgage Debt” means: (i) any bona fide debt (including principal, accrued interest, original issue discount and customary lender or financial insurer, agent and trustee fees, costs, premiums, expenses, indemnities and reimbursement obligations (whether liquidated or contingent) with respect thereto, and including all payment obligations under interest rate hedging agreements with respect thereto and reimbursement obligations with respect thereto to any financial insurer) and/or an assignment in connection with a securitization transaction secured by a Leasehold Mortgage relating to the Utility System and granted to a Person pursuant to an agreement entered into prior to the occurrence of any Adverse Action, University Default, or any event of termination, cancellation, rescinding, or voiding referred to in Section 16.4 giving rise to the payment of amounts for or in respect of termination under this University Lease. For the purposes of determining the Utility System Concession Value, Leasehold Mortgage Debt shall not include: (i) debt from an Affiliate of UMLLC, unless such debt is on terms consistent with terms that would be reasonably expected from a non-Affiliate lender acting in good faith and otherwise complies with the requirements of Leasehold Mortgage Debt set forth above; (ii) any increase in debt to the extent such increase is the result of an agreement or other arrangement entered into after UMLLC was aware (or should have been aware), using reasonable diligence, of the prospective occurrence of an event giving rise to the payment of Leasehold Mortgage Debt; or (iii) any debt with respect to which the Leasehold Mortgagee did not provide the University with notice of its Leasehold Mortgage in accordance, in all material respects, with the Leasehold Mortgage Notice Requirements.

“Leasehold Mortgagee” means the holder or beneficiary of a Leasehold Mortgage or a trustee or agent acting on behalf of such holder or beneficiary, including the Lessor in a lease or Leveraged Lease.

“Leasehold Mortgagee Notice Requirements” means the delivery by a holder or beneficiary of a Leasehold Mortgage to the University, not later than ten (10) Days after the execution and delivery of such Leasehold Mortgage by UMLLC, of a true and complete copy of the executed original of such Leasehold Mortgage, together with a notice containing the name and post office address of the holder of such Leasehold Mortgage, which may be an agent on behalf of the provider of the Leasehold Mortgage Debt.

“Leasehold Mortgagee’s Notice” has the meaning ascribed thereto in Section 19.7(a).

“Legislature” means the Louisiana State Legislature.

“Lessor” means a Leasehold Mortgagee that has purchased all or a portion of the UMLLC Interest and leased that interest in the UMLLC Interest to UMLLC.

“Letter of Credit” means a committed, irrevocable, unconditional, commercial letter of credit, in favor of the University, in form and content reasonably acceptable to the University, payable in U.S. dollars upon presentation of a sight draft and a certificate confirming that the University has the right to draw under such letter of credit in the amount of such sight draft, without presentation of any other Document, which letter of credit (i) is issued by a commercial bank or trust company that is a member of the New York Clearing House Association or the Clearing House Interbank Payments System and that has a current credit rating of A-2 or better by Standard & Poor’s Ratings Services and an equivalent credit rating by another Credit Rating Agency (or such other commercial bank or trust company reasonably acceptable to the University and Approved by the University prior to the submission of the letter of credit) or such other commercial bank or trust company that is Approved by the University, and (ii) provides for the continuance of such letter of credit for a period of at least one (1) Year or as otherwise provided in this University Lease. The office for presentment of sight drafts specified in the Letter of Credit shall be located (a) at a specified street address within the City of Baton Rouge, Louisiana or other location acceptable to the University or (b) at a facsimile number located within the United States.

“Leveraged Lease” means a lease, sublease, concession, management agreement, operating agreement or other similar arrangement in which the Lessor has borrowed a portion of the purchase price of the interest in the UMLLC Interest acquired by the Lessor and granted to the lenders of those funds a security interest in that interest.

“LIBOR” means the London Interbank Offered Rate.

“Loss” means, with respect to any Person, any loss, claim, liability, damage, penalty, amount paid pursuant to a settlement, charge, or out-of-pocket and documented cost or expense (including fees and expenses of counsel and any Tax losses) actually suffered or incurred by such Person but excluding any punitive, special, exemplary, indirect, and consequential damages and any contingent liability until such liability becomes actual, except, for the avoidance of doubt, to the extent the same are part of a Third Party Claim pursuant to Article 12 (provided that, for the avoidance of doubt, an actual loss, claim, liability, damage of any Contractor or Representative of UMLLC and for which UMLLC is liable subject only to receiving payment in respect thereof from the University, shall not be treated as a contingent liability for this purpose).

“LSU” has the meaning ascribed thereto in the recitals of this University Lease.

“Main Powerhouse” means the “Main Powerhouse” as described or depicted Schedule 3A.

“Major KPI Event” means any single KPI Event that obligates UMLLC to pay KPI Compensation to the University, with respect to that KPI Event only, in an amount equal to the greater of (i) two million five hundred thousand dollars (\$2,500,000) and (ii) ten percent (10%) of the Utility Fee.

“Material Adverse Effect” means a material adverse effect (after taking into account contemporaneous material positive effects) on the business, operations, financial condition, or results of operations of the Utility System taken as a whole or on the ability of the University to consummate the Transaction or perform any material obligation hereunder; *provided, however*, that no effect arising out of or in connection with or resulting from any of the following shall be deemed, either alone or in combination, to constitute or contribute to a Material Adverse Effect: (i) general economic conditions or changes therein; (ii) financial, banking, currency or capital markets fluctuations or conditions (either in the United States of America or any international market and including changes in interest rates); (iii) conditions affecting the financial services or utility industries generally; (iv) any existing event or occurrence of which UMLLC has actual knowledge as of the Turnover Date; (v) any action, omission, change, effect, circumstance, or condition contemplated by this University Lease or attributable to the execution, performance, or announcement of this University Lease or the Transaction (except for any litigation relating thereto or to this University Lease (or the matters contemplated herein)); and (vi) negligence, intentional misconduct, or bad faith of UMLLC or its Representatives.

“Material Change” means any material change in the dimensions, character, quality, or location of any part of the Utility System that would not be considered Capital Improvements.

“Maximum Budgeted IMP Amount” has the meaning ascribed thereto in Section 2.4(f).

“Memorandum of Sub-Lease” has the meaning ascribed thereto in Section 2.8.

“New Agreement” has the meaning ascribed thereto in Section 19.5(a).

“New Approved Capital Improvement” has the meaning ascribed thereto in Schedule 5.

“New Approved Capital Improvement Cost” has the meaning ascribed thereto in Schedule 5.

“Notice Period” has the meaning ascribed thereto in Section 12.4(b).

“Obligation Payment” has the meaning ascribed thereto in Section 12.7.

“Obligee” means any Person entitled to the benefit of a payment obligation under Article 12.

“Obligor” means any Person obligated to meet a payment obligation under Article 12.

“Offsets” has the meaning ascribed thereto in Section 12.11(a).

“Open Book Basis” means, with respect to the proposed costs of any Capital Improvement, allowing the University to review all underlying assumptions and data associated with the cost of delivering such Capital Improvement, including, without limitation, assumptions as to costs of the design, construction, and installation of such Capital Improvement, schedule, composition of equipment spreads, equipment rates, labor rates, productivity, estimating factors, design and productivity allowance, contingency and indirect costs, risk pricing, discount rates, interest rates, inflation and deflation rates, and other items reasonably required by the University to satisfy themselves as to the reasonableness and accuracy of the amount.

“Operating Agreement” means any material agreement, contract, or commitment to which UMLLC is a party or otherwise relating to the Utility System Operations as in force from time to time (including any warranties or guaranties), but excluding any Leasehold Mortgage and financing documents related thereto.

“Operating Agreements and Plans” has the meaning ascribed thereto in Section 3.11(a).

“Operations Plan” has the meaning ascribed thereto in Schedule 2.

“Operator” has the meaning ascribed thereto in Section 3.3(a).

“Operator Evaluation Period” means, as applicable, (i) the period commencing on the Day immediately following the Turnover Date and ending on the first (1st) anniversary thereof or (ii) each subsequent one (1) -year period after the period described in clause (i). For the avoidance of doubt, such one (1) -year period is a fixed period, rather than a rolling period.

“Parallel Issue” has the meaning ascribed thereto in Section 1.22.

“Party” means a party to this University Lease and “Parties” means both of them.

“Pass-Down Provisions” has the meaning ascribed thereto in Section 1.23.

“Payment Bond” has the meaning ascribed thereto in Section 21.6(a)(i).

“Performance Bond” has the meaning ascribed thereto in Section 21.6(a)(ii).

“Performance Standards” means (i) for the period commencing upon Turnover until the IMP Substantial Completion of the Initial Modernization Project, the Interim Performance Standards, and (ii) for the period commencing upon IMP Substantial Completion of the Initial Modernization Project through the remainder of the Term, the standards, specifications, policies, procedures, and processes that apply to the operation of, maintenance of, and rehabilitation of the Utility System set forth in Schedule 2A and the appendices thereto (as may be modified pursuant to the terms hereof). To the extent that any term or provision set forth in Schedule 2A or incorporated by reference in Schedule 2A conflicts with any term or provision specified in this University Lease, then such term or provision of this University Lease shall govern and shall supersede any such conflicting term or provision.

“Permitted UMLLC Encumbrance” means, with respect to the UMLLC Interest: (i) any Encumbrance that is being contested in accordance with Section 3.5(a) (but only for so long as

such contest effectively postpones enforcement of any such Encumbrance); (ii) any (A) lien or security interest for obligations not yet due and payable to a Contractor or other Person, (B) statutory lien, deposit, or other non-service lien or (C) lien, deposit, or pledge to secure mandatory statutory obligations or performance of bids, tenders, contracts (other than for the repayment of borrowed money) or leases, or for purposes of like general nature, any of which are incurred in the ordinary course of business of all or any part of the Utility System Operations and are either (x) not delinquent or (y) which are being contested, or being caused to be contested, by UMLLC in accordance with Section 3.5(a) (but only for so long as such contest effectively postpones enforcement of any such Encumbrance); (iii) inchoate materialmen's, mechanics', workmen's, repairmen's, employees', carriers', or warehousemen's liens or other like Encumbrances arising in the ordinary course of business of all or any part of the Utility System or UMLLC's performance of any of its rights or obligations hereunder, and either (A) are not delinquent or (B) are being contested by UMLLC in accordance with Section 3.5(a) (but only for so long as such contest effectively postpones enforcement of any such Encumbrance); (iv) any right reserved to or vested in any Governmental Authority or the University by any statutory provision or under common law (it being understood and agreed that nothing in this clause (iv) shall limit or otherwise affect the University's obligations or UMLLC's rights hereunder); (v) any other Encumbrance permitted hereunder (including any Leasehold Mortgage (and financing statements or other means of perfection relating thereto)); (vi) liens incurred in the ordinary course of business in connection with workers' compensation, unemployment insurance, social security, and other governmental rules and that do not in the aggregate materially impair the use, value, or operation of the Utility System; (vii) any Encumbrances created, incurred, assumed, or suffered to exist by the University or any Person claiming through the University; (viii) any Encumbrance, security interest, or pledge imposed upon UMLLC and any Affiliate as to UMLLC's and any Affiliate's assets arising from borrowings, financings, leases or similar transactions in the ordinary course of business; (ix) any Encumbrances in existence as of Turnover not caused by UMLLC, the Concessionaire, the Operator, or any of their respective Representatives; (x) the Concession Agreement; and (xi) any amendment, extension, renewal or replacement of any of the foregoing.

"Permitted University Encumbrance" means: (i) the UMLLC Interest; (ii) any Encumbrance that is being contested, or being caused to be contested, by the University in accordance with Section 3.5(b) (but only for so long as such contest effectively postpones enforcement of any such Encumbrance); (iii) inchoate materialmen's, mechanics', workmen's, repairmen's, employees', carriers', or warehousemen's liens or other like Encumbrances arising in the University's performance of any of its rights or obligations hereunder, and either (A) are not delinquent or (B) are being contested, or are being caused to be contested, by the University in accordance with Section 3.5(b) (but only for so long as such contest effectively postpones enforcement of any such Encumbrance); (iv) any easement, covenant, condition, right-of-way, or servitude (or other similar reservation, right, and restriction) or other defects and irregularities in the title to the applicable assets that do not materially interfere with the Utility System Operations or the rights and benefits of UMLLC under this University Lease or materially impair the value of the UMLLC Interest from and after the Turnover Date; (v) any zoning, building, environmental, health, safety, or other Law; (vi) the police and regulatory powers of the State or the City-Parish with respect to the Utility System, and the regulation of the use of the Public Way (it being understood and agreed that nothing in this clause (vi) shall prevent any exercise of such powers being an Adverse Action if it meets the definition thereof); (vii) any right reserved to or vested in any Governmental Authority by any statutory provision or under common law (it being understood

and agreed that nothing in this clause (vii) shall prevent any exercise of such right being an Adverse Action if it meets the definition thereof); (viii) any other Encumbrance permitted hereunder; (ix) any Encumbrances created, incurred, assumed, or suffered to exist by UMLLC or any Person claiming through it (provided that this shall not grant UMLLC, or any Person claiming through UMLLC, the right to create, incur, assume, or suffer to exist any such Encumbrance unless otherwise expressly contemplated herein); (x) any rights reserved to or vested in the University by any statutory provision (it being understood and agreed that nothing in this definition shall limit or otherwise affect the University's obligations or UMLLC's rights hereunder); (xi) any of the Encumbrances set forth on Schedule 10; (xii) (A) any Encumbrances reflected in any leasehold title insurance policies (or any other title policies related to the Transaction) issued to UMLLC or any Leasehold Mortgagee in connection with the Transaction, or (B) if no such policies are issued in connection with the Transaction, any Encumbrances reflected in the Title Commitment which are not cured, satisfied, released or removed from the Title Commitment prior to closing of financing of the Initial Modernization Project; (xiii) this University Lease; and (xiii) any amendment, extension, renewal or replacement of any of the foregoing.

“Person” means any individual (including, the heirs, beneficiaries, executors, legal representatives or administrators thereof), corporation, partnership, joint venture, trust, limited liability company, limited partnership, joint stock company, unincorporated association, or other entity or a Governmental Authority, including the University.

“Planned IMP Substantial Completion Date” means May 30, 2024, as such date may be extended in accordance with the terms of this University Lease.

“Preliminary Design” shall mean the approximately thirty percent (30%) design for the Initial Modernization Project attached hereto as Schedule 7, which Preliminary Design shall include the Maximum Budgeted IMP Amount for the final design and construction of one hundred percent (100%) of the Initial Modernization Project pursuant to the Drop-Down DB Contract.

“Project Intellectual Property” has the meaning ascribed thereto in Section 3.11(b).

“Property” has the meaning ascribed thereto in the recitals of this University Lease.

“Property Taxes” means any ad valorem property Tax attributable to the Utility System or the UMLLC Interest, including an ad valorem tax on real property and improvements, buildings, structures, fixtures and all tangible personal property.

“Prorated Items” means all revenues, charges, costs, and expenses with respect to Assumed Liabilities.

“Prudent Industry Practices” means, at a particular time, those practices, methods, standards, and acts which are engaged in and generally accepted by prudent providers of services of the kind contemplated by this University Lease in the United States, taking into account practices, methods, and acts in use at Comparable Utility Systems or individual utility facilities forming part of Comparable Utility Systems, life-cycle maintenance costs and considerations, and the design, engineering, construction, testing, operation, and maintenance requirements set out in this University Lease, and which, in the exercise of reasonable judgment at the time the decision was made, could reasonably have been expected to achieve the desired result consistent with

applicable Law, safety, reliability, efficiency and expedition. “Prudent Industry Practices” is not intended to be limited to the optimum practice or method to the exclusion of all others, but rather to be a spectrum of reasonable practices, methods, standards and acts.

“Public Way” means the streets, alleys, driveways, and sidewalks owned by the University.

“Quarter” means each calendar quarter of each Fiscal Year of the Term.

“Reconciliation Statement” has the meaning ascribed thereto in Section 7.1(b).

“Record Design Documents” means the IMP Design Documents which provide the complete and final documents necessary or related to construction, operations, and maintenance of the Initial Modernization Project or any portion thereof.

“Record Retention Policy” has the meaning ascribed thereto in Section 3.12(a).

“Recovery Period” has the meaning ascribed thereto in Schedule 5.

“Release” means depositing, spilling, leaking, pumping, pouring, emitting, discarding, abandoning, emptying, discharging, injecting, escaping, leaching, dumping, or disposing of any Hazardous Substances into the Environment.

“Repetitive Failure” means a Repetitive Non-Major KPI Event or a Repetitive Performance Standards Failure.

“Repetitive Non-Major KPI Event” means, during any given Operator Evaluation Period, the occurrence of a KPI Event for a particular Key Performance Indicator three (3) or more times during such Operator Evaluation Period.

“Repetitive Performance Standards Failure” means, during any given Operator Evaluation Period, the failure to comply with or to meet a distinct requirement of the Performance Standards (provided that the University shall have provided separate written notices for each such failure) three (3) or more times during such Operator Evaluation Period.

“Representative” means, with respect to any Person, any director, officer, employee, official, partner, member, owner, agent, lawyer, accountant, auditor, professional advisor, consultant, engineer, Contractor, other Person for whom such Person is at law responsible or other representative of such Person and any professional advisor, consultant or engineer designated by such Person as its “Representative”. For the avoidance of doubt, the Operator (if other than the Concessionaire) shall be deemed a Representative of the Concessionaire.

“Required Coverages” has the meaning ascribed thereto in Section 13.2.

“Restoration” has the meaning ascribed thereto in Section 13.4(a)(ii).

“Restoration Funds” has the meaning ascribed thereto in Section 13.4(a)(iii).

“Restoration Shortfall Amount” has the meaning ascribed thereto in Section 13.4(a)(iii).

“Restricted Person” means any Person that (a) to the knowledge of UMLLC after reasonable diligence and due inquiry, directly or indirectly, is acting in contravention of any United States or other applicable international anti-money laundering regulations or conventions, (b) is included on the List of Specially Designated Nationals and Blocked Persons maintained by the United States Treasury Department’s Office of Foreign Assets Control (“OFAC”), which list may be found at www.treas.gov/ofac, (c) operating, organized, or residing in a country or territory named on an OFAC list or which is designated as a Non-Cooperative Jurisdiction by the Financial Action Task Force on Money Laundering, which designation can be found at www.fatf-gafi.org, or whose funds are transferred from or through such a jurisdiction, (d) operates, resides in, or is organized under the laws of a jurisdiction designated by the Secretary of the Treasury as warranting special measures due to money laundering concerns, which designation can be found at www.fincen.gov, (e) is a Foreign Shell Bank, or (f) has been debarred or suspended for cause from entering into contracts with the University or the State.

“Reversion Date” means the Business Day immediately following the End Date.

“Revised Proration Statement” has the meaning ascribed thereto in Section 2.2(b)(ii).

“Satellite Plants” means, collectively, each plant located adjacently and supplying Utilities to any of the following locations on the University Campus: (a) the South Campus, (b) the Nicholson Gateway Building, (c) the Recreation Center Building, (d) the Laboratory School Building, (e) the Union Center Building, (f) the 459 Complexes, (g) The Five Building, (h) the Cypress Building, and (i) the Ed Gay Building.

“SC Punch List” means the itemized list of Construction Work that remains to be completed in order to satisfy the conditions to achieving IMP Substantial Completion, prepared by UMLLC and included in the D&C Closeout Plan in accordance with Section 21.1.

“Schedule” means a schedule attached hereto and incorporated in this University Lease, unless otherwise expressly indicated by the terms of this University Lease.

“Securities Act” means the United States Securities Act of 1933, as amended.

“Senior Officials” has the meaning ascribed thereto in Section 3.3(c)(i)(A).

“Shared Spaces” has the meaning ascribed thereto in Section 3.30.

“State” means the State of Louisiana.

“Supplies” has the meaning ascribed thereto in Section 7.3(a).

“Supply Contract” has the meaning ascribed thereto in Section 7.3(a).

“Supply Costs” means the purchase price of Supplies in accordance with the applicable Supply Contract, inclusive of any taxes, including sales, use or excise taxes, applicable to such Supplies and all out-of-pocket costs incurred in the procurement of Supplies (including any transmission costs, riders or other similar costs reasonably necessary to procure Supplies).

“Target” has the meaning ascribed thereto in Schedule 15.

“Tax” means any federal, state, local, or foreign income, gross receipts, commercial activity, license, payroll, employment, excise, severance, stamp, occupation, premium, windfall profits, environmental, customs duties, permit fees, capital stock, franchise, profits, withholding, social security, unemployment, disability, real property, personal property, parking, sales, use, transfer, registration, value added, alternative or add-on minimum, estimated or other tax, levy, impost, stamp tax, duty, fee, withholding or similar imposition of any kind payable, levied, collected, withheld, or assessed at any time, including any interest, penalty or addition thereto, whether disputed or not.

“TEP” has the meaning ascribed thereto in the recitals of this University Lease.

“Term” has the meaning ascribed thereto in Section 2.1.

“Termination Damages” has the meaning ascribed thereto in Section 14.2(a).

“Third Party Agreement” has the meaning ascribed thereto in Section 3.18.

“Third Party Claim” means any Claim asserted against an Obligee by any Person who is not a Party or an Affiliate of such a Party.

“Time of Turnover” means 9:00 a.m. in Baton Rouge, Louisiana, on the Turnover Date.

“Title Commitment” means any commitment obtained by UMLLC, at its cost, for a leasehold title policy or policies, proposing to insure the leasehold interest of UMLLC in the Utility System Land, to the extent of such leasehold interest, prior to Turnover, issued by Title Company.

“Title Company” means [•] through Phelps Title Agency, L.L.C.

“Transaction” has the meaning ascribed thereto in Section 2.1.

“Transfer” means to sell, convey, assign, lease, sublease, mortgage, encumber, transfer, or otherwise dispose of.

“Transferee” means any Person who obtains the UMLLC Interest pursuant to a Transfer.

“Turnover” has the meaning ascribed thereto in Section 2.2(a).

“Turnover Date” has the meaning ascribed thereto in Section 2.2(a).

“Ultimate Holding Entity” means, in relation to any Person, the ultimate holding entity of that Person, and in respect of UMLLC as of the date of this University Lease, means the Foundation.

“UMI CEA” has the meaning ascribed thereto in the recitals of this University Lease.

“UMLLC” has the meaning ascribed thereto in the preamble to this University Lease.

“UMLLC Default” has the meaning ascribed thereto in Section 16.1(a).

“UMLLC Interest” means the interest of UMLLC in the Utility System created by this University Lease and the rights and obligations of UMLLC under this University Lease.

“UMLLC Liaison” means the University’s [•], or such other Person as may be identified by UMLLC to the University in writing.

“UMLLC Parent” means the Person, if any, that owns, and only owns, one hundred percent (100%) of the shares of the capital stock, units, partnership or membership interests, other equity interests and equity securities, to the extent applicable, of UMLLC; as of the date of this University Lease, the UMLLC Parent means the Foundation.

“UMLLC Required Coverages” has the meaning ascribed thereto in Section 13.1.

“UMLLC Utility System Employees” means those Persons employed by UMLLC or Concessionaire immediately prior to the End Date whose duties directly relate to the provision of the Utility Services.

“Uncapped O&M Costs” means the sum of the following specifically identified out-of-pocket operating and maintenance costs and expenses incurred by UMLLC (which costs and expenses shall include payments due and payable by UMLLC or the Concessionaire to the Operator or other Contractors pursuant to an Operating Agreement or similar agreement) or the Operator in operating the Utility System and complying with their respective obligations under this University Lease: (a) costs incurred due to a Delay Event, provided that for events described in clause (iii) of the definition of “Delay Event”, Uncapped O&M Costs shall only include those costs (which are not costs incurred to make Capital Improvements) necessary to bring the Utility System into compliance with the applicable Law and not the ongoing costs associated therewith; (b) costs incurred to modify the location or configuration of the Utility System as directed by the University pursuant to Section 3.21 (but only to the extent such costs are not costs incurred to make a Capital Improvement); (c) costs incurred by UMLLC pursuant to Section 4.3(c)(ii) if the relevant proposed Capital Improvement or Material Change is not Approved by the University; (d) costs incurred to disconnect real property from the Utility System if required pursuant to Section 5.3(a); (e) costs incurred in connection with a modification to the Performance Standards pursuant to Section 6.3(a); (f) costs incurred to perform the obligations set forth in Section 7.4, but only to the extent such costs were Approved by the University prior to being incurred; (g) costs incurred to pay Property Taxes, if such costs are included in Uncapped O&M Costs pursuant to Section 3.8; (h) costs incurred to make time-sensitive repairs or improvements to (A) the Utility System or (B) the University-owned property related to, but not a part of, the Utility System, in each case to the extent such repairs or improvements (w) are not Capital Improvements, (x) were not contemplated in the most recently approved Five-Year Plan, (y) were either (I) made in UMLLC’s good-faith belief that they were being made to the Utility System or (II) made in UMLLC’s good-faith belief that the repair was the best first response to an Emergency, and (z) have been Approved by the University in its discretion; (i) storm water and sanitary effluent charges assessed by the City-Parish, except to the extent that such storm water and sanitary effluent charges increase as a result of an action or inaction of UMLLC (other than the actions or inactions that UMLLC is directed or obligated to take or omit pursuant to this University Lease, including

in order to comply with the Performance Standards); (j) an Approved Capital Improvement that is classified as Uncapped O&M Costs pursuant to Section 4.3(h) or an Approved Material Change (unless such costs are treated as another form of compensation to UMLLC provided for in this University Lease in connection with the Approval of such Material Change), in each case up to the amount Approved by the University as part of its Approval of such Capital Improvement or Material Change; (k) costs incurred in connection with Supply procurement assistance under Section 7.3(a) or Section 7.3(b), but only to the extent such costs were Approved by the University prior to being incurred; (l) costs (including KPI Compensation) incurred as a direct result of UMLLC's failure to comply with Law or this University Lease if the sole reason for such failure is that the University failed to be reasonable in its Approval of all possible Capital Improvements or Material Changes that would cure or prevent such failure to comply with such Law or this University Lease; (m) costs associated with a University Directive that is not the construction of a Capital Improvement in accordance with Section 5.1, (n) legal fees arising out of any Excluded Liabilities; (o) the costs of any premium for insurance coverage procured by UMLLC in accordance with Section 13.1; *provided* that such coverage and the cost thereof has been Approved by the University prior to the purchase thereof; *provided, further*, that with respect to any Approved Capital Improvement or Material Change, such coverage and the cost thereof is expressly included in the request for Approval of such Capital Improvement or Material Change and the University Approves such cost; (p) the operations and maintenance costs that are reasonably necessary to cause the Utility System or Utility System Operations to comply with the enactment of a new Law or the modification, amendment or change in enforcement or interpretation of a Law (including a change in the application or implementation thereof by any Governmental Authority) arising after the Turnover Date but solely for the first 3 full Fiscal Years (and any partial Fiscal Year) after the occurrence of such enactment, modification, amendment or change (but not, for the avoidance of doubt, those costs that are included in any other clause of this definition; (q) operations and maintenance costs to the extent reasonably incurred by UMLLC to rectify an Extraordinary Failure that is neither insured pursuant to Article 13 nor caused by the act, omission, negligence, or willful misconduct of, or violation of applicable Law by, UMLLC, its Affiliates or their respective Representatives; and (r) a cost expressly described as an Uncapped O&M Cost in Section 3.7(c) or Section 3.7(e).

“University” has the meaning ascribed thereto in the preamble to this University Lease.

“University Campus” has the meaning ascribed thereto in the recitals to this University Lease as more particularly shown on Schedule 16.

“University Claim” has the meaning ascribed thereto in Section 1.20.

“University Default” has the meaning ascribed thereto in Section 16.2(a).

“University Directive” means a written order or directive prepared by or on behalf of the University in conformity with the requirements and limitations of this University Lease directing UMLLC, to the extent permitted hereby, other than pursuant to Section 3.21, to: (i) add to, or perform work in respect of, the Utility System in addition to that provided for in this University Lease (including (a) work within the University Campus on utility facilities or energy equipment that are not and will not be considered part of the Utility System in accordance with the definition thereof, (b) taking control of the internal the University billing system for Utilities, and (c) causing

UMLLC to engage in sustainability practices in excess of those reasonably required by Prudent Industry Practices); or (ii) change the dimensions, character, quantity, quality, description, location, or position of any part of the Utility System or make other changes to the Utility System; *provided that*, notwithstanding the foregoing, (1) as part of any such order or directive or as a separate order or directive, the University may cause certain personal property to be deemed Utility System Assets and part of the Utility System even if such personal property is beyond the line of demarcation for the applicable Utility as set forth in the Performance Standards and may cause UMLLC to purchase and/or install such personal property, provided that if any such personal property would be beyond the line of demarcation for the applicable Utility as set forth in the Performance Standards, such order or directive may only be issued with the approval of UMLLC, acting reasonably, (2) any such order or directive can include the design, demolition, project management, construction, repair, replacement, remodeling, renovation, reconstruction, enlargement, addition, alteration, painting, or structural or other improvements not included in the Utility Facilities but related thereto, provided that such work must be part of a larger project (as determined by the University in its reasonable discretion) for which the Utility System is the primary driver of such project (as determined by the University in its reasonable discretion), (3) the University may, in any such order or directive, direct the manner and means by which UMLLC performs a University Directive, and (4) no such order or directive may in any event order or direct UMLLC to do any act that is not technically feasible or could reasonably be expected to violate any applicable Law, contravene any Consent or Authorization issued by a Governmental Authority, cause a material insured risk to become uninsurable or cause UMLLC to fail to be in compliance with this University Lease. Notwithstanding anything herein to the contrary, the University may not issue a University Directive to UMLLC for any portion of the Building Mechanical Systems.

“University Lease” has the meaning ascribed thereto in the preamble hereto.

“University Leasing Act” has the meaning ascribed thereto in the recitals of this University Lease.

“University Liaison” means the University’s [•], or such other Person as may be identified by the University to UMLLC in writing.

“University Reimbursable Amount” means an amount equal to two and one half percent (2.5%) of the gross amount of the financing of the Initial Modernization Project but in no event less than [two million five hundred thousand dollars (\$2,500,000)].

“University Required Coverages” has the meaning ascribed thereto in Section 13.2.

“University Responsible Parties” has the meaning ascribed thereto in Section 12.2.

“University’s Option” has the meaning ascribed thereto in Section 19.7(a).

“University Utility System Employees” means those Persons identified on Schedule 4A employed by the University immediately prior to Turnover whose duties directly relate to the operation or maintenance of the Utility System.

“Unplanned Outage” has the meaning ascribed thereto in Schedule 2A or Schedule 2B, as applicable.

“Unrecovered Balance” has the meaning ascribed thereto in Schedule 5.

“Utilities Modernization Initiative” has the meaning ascribed thereto in the recitals of this University Lease.

“Utility” means any of the following specific individual utility services: (i) electricity; (ii) steam and condensate; (iii) chilled water; and (iv) natural gas, and “Utilities” means each of them.

“Utility Facilities” means the improvements and equipment (a) constituting part of those identified in Schedule 3A, that are directly and exclusively involved in the generation, distribution, and return of the Utilities and the operation and maintenance of the Utility System and that are not beyond the line of demarcation for each Utility as set forth in the Performance Standards, or (b) located on Utility System Land; *provided* that the definition of “Utility Facilities” does not include (i) any improvements or equipment that are beyond the line of demarcation for each Utility as set forth in the Performance Standards, except for those areas (I) expressly set forth in the Performance Standards as being within said line of demarcation or (II) which the University directs to be part of the Utility System as part of a University Directive in accordance with the definition thereof, (ii) any cameras or other public safety equipment installed, maintained, or used by the Louisiana State University Police Department or any successor department, (iii) the Satellite Plants, or (iv) any portion of the Building Mechanical Systems. For the avoidance of doubt, except as set forth in the definition of Distribution Bottlenecks, no part of the Distribution System shall be included within the scope of the Utility Facilities unless and until such part of the Distribution System has become the subject of a Distribution System Capital Improvement.

“Utility Fee” means the fee established as compensation for the Utility Services, as set forth on Schedule 5 and as may be adjusted pursuant to the terms of this University Lease, including Schedule 5.

“Utility Services” means the services to be provided by UMLLC as grantee of the concession under this University Lease. For the avoidance of doubt, no services in respect of the Distribution System shall be included within the scope of the Utility Services unless and until such part of the Distribution System has become the subject of a Distribution System Capital Improvement.

“Utility System” means: (A) the personal property, real property, improvements, fixtures, and equipment owned and operated by the University prior to the Time of Turnover to provide the Utilities on the University Campus, specifically limited to (i) the Utility System Assets, (ii) the computer systems and software set forth on Schedule 12, (iii) the Utility Facilities, and (iv) the Utility System Land; *provided, however*, that the “Utility System” shall not include, other than expressly referred to above, (v) any utility distribution facilities or other equipment that is beyond the line of demarcation for each Utility, as set forth in the Performance Standards, except to the extent incorporated into the Utility System by a University Directive, (w) any interest in the Public Way or similar real property, (x) any utility facilities in a building that is not a building leased by UMLLC, up to the Utility System line of demarcation for such building, as described in the

Performance Standards, except to the extent incorporated into the Utility System by a University Directive, (y) the Satellite Plants, or (z) any portion of the Building Mechanical Systems; and (B) from and after the Time of Turnover, such Utility System as it is reconfigured, replaced, improved, or relocated by UMLLC, the Concessionaire or the Operator pursuant to the terms of this University Lease. For the avoidance of doubt, except as set forth in the definition of Distribution Bottlenecks, no part of the Distribution System shall be included within the scope of the Utility System unless and until such part of the Distribution System has become the subject of a Distribution System Capital Improvement.

“Utility System Assets” means (i) as of the time immediately prior to the Time of Turnover, the personal property of the University used in connection with operations of the Utility System and identified on Part 3 of Schedule 3A as “Personal Property,” and (ii) in addition to the personal property described in clause (i) above, from and after the Time of Turnover, the personal property of UMLLC, the Concessionaire or the Operator used in connection with the operations of the Utility System; *provided* that the definition of “Utility System Assets” does not include any portion of the Building Mechanical Systems.

“Utility System Concession Value” means, at any given date, the fair market value of the UMLLC Interest at the time of the occurrence of the relevant Adverse Action, University Default, or any event of termination, cancellation, rescinding, or voiding referred to in Section 16.4 (but excluding the effect of such Adverse Action, University Default, or event described in Section 16.4), as determined pursuant to a written appraisal prepared in conformity with the Uniform Standards of Professional Appraisal Practice as set forth by the Appraisal Standards Board, or its successor organization, by an independent third party appraiser that is nationally recognized in appraising similar assets and that is acceptable to the University and UMLLC; *provided* that in no event shall such appraisal take into account any Capital Improvement not Approved by the University prior to such time; *provided, further*, that the Utility System Concession Value shall in no event be less than the amount of all Leasehold Mortgage Debt (including Breakage Costs) on the End Date. If the Parties fail to agree upon such a single appraiser within thirty (30) Days after a Party requests the appointment thereof, then the University and UMLLC shall each appoint an independent third party appraiser and both such appraisers shall be instructed jointly to select an independent third party appraiser to make the appraisal referred to above. Each of the University and UMLLC shall pay fifty percent (50%) of the costs and expenses of any appraisal.

“Utility System Land” means those parcels of real property described or depicted in Schedule 3A for the Main Powerhouse, the Cogeneration Building, the Highland Utility Center, and the Vet Med Plant.

“Utility System Operations” means the operation, management, and maintenance of the Utility System and all other actions relating to the Utility System that are performed by or on behalf of UMLLC pursuant to this University Lease.

“Utility System Purposes” means the use of the Utility System to provide Utility Services in support of the University by providing utility services to the University facilities on the University Campus, including to students, faculty, administrators, employees, and invitees of the University thereon and others providing services to the University.

“Variable Fee Component” has the meaning ascribed thereto in Schedule 5.

“Vet Med Plant” means heating and cooling plant located at the University’s School of Veterinary Medicine, described or depicted as the “Vet Med Plant” on Schedule 3A.

“Warranty Period Utility System Projects” means those projects with respect to the Utility System completed by the University prior to the Time of Turnover that remain subject to an ongoing warranty from the contractor responsible for completing such projects and are listed on Schedule 22.

“Year” means the calendar year.

Section 1.2. Number and Gender. In this University Lease, words in the singular include the plural and vice versa and words in one gender include all genders.

Section 1.3. Headings. The division of this University Lease into articles, sections, and other subdivisions is for convenience of reference only and shall not affect the construction or interpretation of this University Lease. The headings in this University Lease are not intended to be full or precise descriptions of the text to which they refer and shall not be considered part of this University Lease.

Section 1.4. References to this University Lease. The words “herein”, “hereby”, “hereof”, “hereto”, “hereunder”, and words of similar import refer to this University Lease as a whole, including the Schedules, and not to any particular portion of it. The words “Article”, “Section”, “paragraph”, “sentence”, “clause”, and “Schedule” mean and refer to the specified article, section, paragraph, sentence, clause, or schedule of or to this University Lease.

Section 1.5. References to Any Person. A reference in this University Lease to any Person at any time refers to such Person’s permitted successors and assignees.

Section 1.6. Meaning of Including. In this University Lease, the words “include”, “includes”, or “including” mean “include without limitation”, “includes without limitation”, and “including without limitation”, respectively, and the words following “include”, “includes”, or “including” shall not be considered to set forth an exhaustive list.

Section 1.7. Meaning of Discretion. In this University Lease, unless otherwise modified, the word “discretion” with respect to any Person means the sole and absolute discretion of such Person.

Section 1.8. Meaning of Notice. In this University Lease, the word “notice” means “written notice”, unless specified otherwise.

Section 1.9. Consents and Approvals. Unless specified otherwise, wherever the provisions of this University Lease require or provide for or permit an approval or consent by either Party, such approval or consent, and any request therefor, must be in writing (unless waived in writing by the other Party).

Section 1.10. Trade Meanings. Unless otherwise defined herein, words or abbreviations that have well-known trade meanings are used herein in accordance with those meanings.

Section 1.11. Laws. Unless specified otherwise, references to a Law are considered to be a reference to (i) such Law as it may be amended from time to time, (ii) all regulations and rules pertaining to or promulgated pursuant to such Law, (iii) the successor to the Law resulting from recodification or similar reorganizing of Laws, and (iv) all future Laws pertaining to the same or similar subject matter.

Section 1.12. Currency. Unless specified otherwise, all statements of or references to dollar amounts or money in this University Lease are to the lawful currency of the United States of America.

Section 1.13. Generally Accepted Accounting Principles. All accounting and financial terms used herein, unless specifically provided to the contrary, shall be interpreted and applied in accordance with GAAP.

Section 1.14. Calculation of Time. For purposes of this University Lease, a period of Days shall be deemed to begin on the first Day after the event that began the period and to end at 5:00 p.m., which time shall be determined by the time in the City of Baton Rouge, Louisiana on the last Day of the period. If, however, the last Day of the period does not fall on a Business Day, the period shall be deemed to end at 5:00 p.m., which time shall be determined by the time in the City of Baton Rouge, Louisiana on the next Business Day.

Section 1.15. Approvals, Consents and Performance by the University.

- (a) *Procedures.* Wherever the provisions of this University Lease require or provide for or permit an approval or consent by the University of or to any action, Person, Document, or other matter contemplated by this University Lease, the following provisions shall apply: (i) such request for approval or consent must (1) contain or be accompanied by any documentation or information required for such approval or consent in reasonably sufficient detail, as reasonably determined by the University, (2) clearly set forth the matter in respect of which such approval or consent is being sought, (3) form the sole subject matter of the correspondence containing such request for approval or consent, and (4) state clearly that such approval or consent is being sought; (ii) such approval or consent shall not be unreasonably withheld, conditioned, or delayed (unless such provision provides that such approval or consent may be unreasonably withheld, conditioned, or delayed or is subject to the discretion of the University); (iii) the University shall advise UMLLC by written notice either that it consents or approves or that it withholds its consent or approval, in which latter case it shall set forth, in reasonable detail, its reasons for withholding its consent or approval, which reasons may include the insufficiency, as determined by the University acting reasonably, of the information or documentation provided; (iv) unless a time period is specifically set forth elsewhere herein, the University shall, within thirty (30) Days after receipt of UMLLC's request, (1) provide the responding notice mentioned in clause (iii) of this Section 1.15(a) or (2) if the University determines in its discretion that

additional time to consider such request would be appropriate due to the request's complexity or interrelationship with larger University issues, advise UMLLC by written notice of a reasonable timeframe (not to exceed ninety (90) Days) in which the University will provide the responding notice mentioned in clause (iii) of this Section 1.15(a), which written notice shall extend the timeframe for Approval of the request to the timeframe set forth in such notice; (v) if the responding notice mentioned in clause (iii) of this Section 1.15(a) indicates that the University does not approve or consent, UMLLC may take whatever steps may be necessary to satisfy the objections of the University set out in the responding notice and, thereupon, may resubmit such request for approval or consent from time to time and the provisions of this Section 1.15 shall again apply; (vi) if the disapproval or withholding of consent mentioned in clause (iii) of this Section 1.15(a) is subsequently determined pursuant to Article 18 to have been improperly withheld or conditioned by the University, such approval or consent shall be deemed to have been given on the date by which such approval or consent should have been provided; *provided* that, to the extent any deadlines for performing work are determined by reference to the date of consent or approval, such consent or approval shall be deemed to have been given on the date of determination rather than the date such consent or approval should have been provided; and (vii) for the avoidance of doubt, any dispute as to whether or not a consent or approval has been unreasonably withheld, conditioned or delayed shall be resolved in accordance with the provisions of Article 18. UMLLC shall submit any request for approval or consent to the University Liaison, who will direct such request to the appropriate committee, Person or group within the University.

- (b) *Approved Documents.* Subject to the other provisions hereof, wherever in this University Lease or the Concession Agreement an approval or consent by the University or UMLLC is required with respect to any document, proposal, certificate, plan, drawing, specification, contract, agreement, budget, schedule, report, or other written instrument whatsoever (a "Document"), following such Approval such Document shall not be amended, supplemented, replaced, revised, modified, altered, or changed in any manner whatsoever without obtaining a further Approval in accordance with the provisions of this Section 1.15.
- (c) *Consent by the University.* Wherever the provisions of the Concession Agreement require or provide for or permit an approval or consent by UMLLC, such provisions shall be deemed also to require or provide for or permit the approval or consent by the University as precedent condition to the effectiveness of UMLLC's approval or consent pursuant to this Section 1.15; *provided, however*, for the avoidance of doubt, such approval or consent by the University shall be a Parallel Issue.

Section 1.16. Incorporation of Schedules. The Schedules are integral to, and are made a part of, this University Lease. In the event of any conflict between the terms of this University Lease and the terms of the Schedules, the terms of this University Lease shall control.

Section 1.17. References to Agreements Generally. References to agreements (including this University Lease) and other contractual instruments shall be deemed to include all

amendments, restatements, extensions and other modifications to such instruments, whether in effect as of the date hereof or made thereafter.

Section 1.18. Cost Responsibilities. In this University Lease, the phrases “at the Concessionaire’s sole cost and expense”, “at the Concessionaire’s cost and expense”, “the Concessionaire shall be responsible for providing”, “the Concessionaire shall pay”, “the Concessionaire shall reimburse”, and similar phrases and provisions that require the Concessionaire to take certain actions or perform certain services, shall not mean that such costs or expenses, or the costs and expenses associated with such actions or activities, are necessarily subject to recovery as part of the Utility Fee or otherwise in accordance with this University Lease. The inclusion of such costs and expenses in the Utility Fee shall be determined in accordance with Schedule 5.

Section 1.19. Out-of-Pocket Costs. In this University Lease, any reference to “out-of-pocket” or “out of pocket” costs or expenses of UMLLC, the Concessionaire or Operator and similar phrases and provisions shall mean the reasonable, incremental actual costs paid by UMLLC, the Concessionaire or Operator to a third party that (i) is not an Affiliate of the Concessionaire, the Operator, or any Equity Participant or (ii) is an Affiliate of the Concessionaire, the Operator, or any Equity Participant, provided that the payments to such Affiliate are on arms’ length terms consistent with those terms offered by unaffiliated third parties for similar goods or services.

Section 1.20. Interaction with the Concession Agreement.

- (a) Notwithstanding any other provision of this University Lease, to the extent that UMLLC is or becomes obligated under the Concession Agreement to take any action, do anything or perform any obligation in connection with the Transaction, the University agrees that, except as otherwise specified herein, it will be obligated to take any such action, do any such thing or perform any such obligation under this University Lease in the manner and to the standard specified herein or, in the absence of any such standard, such standard specified in the Concession Agreement.
- (b) Where the University has the right to exercise any discretion, grant or refuse to grant an approval, accept or refuse to accept a request or submission, make any determination or confirm its satisfaction under this University Lease in respect of any matter, and UMLLC has a corresponding right to exercise any discretion, grant or refuse to grant an approval, accept or refuse to accept a request or submission, make any determination or confirm its satisfaction pursuant to the terms of the Concession Agreement in respect of the same or substantially the same or similar matter, and where the University has exercised its rights in a particular manner, UMLLC shall only be entitled to exercise its discretion, grant or refuse to grant an approval, accept or refuse to accept a request or submission or make the relevant determination in a manner that is consistent with the discretion exercised, approval granted or refused, request or submission accepted or refused or determination made or level of satisfaction confirmed by the University under this University Lease.

- (c) Where the University asserts or exercises any right against UMLLC in accordance with this University Lease in regard to any matter associated with the Transaction or the Concessionaire, including reductions in or retentions from payments under this University Lease, claims for indemnification and claims for damages for breach of this University Lease (such assertion or exercise of rights by the University being referred to as a “University Claim”), any determination made or reached under this University Lease as to the amount, nature and extent of UMLLC’s liability in relation to any University Claim shall be binding on the Concessionaire, provided that UMLLC may not compromise any University Claim without the prior written consent of the Concessionaire, in its sole discretion. The Concessionaire shall bear and discharge on a current basis, and shall indemnify UMLLC against all Losses reasonably and properly incurred by UMLLC related to any University Claim, except to the extent that (1) such Losses arise from a “UMLLC Default” (as such term is defined and used in the Concession Agreement) or (2) the liability for the relevant University Claim will be shared by UMLLC and Concessionaire, in which case, each of UMLLC and Concessionaire shall bear a fair and reasonable proportion of the related costs and expenses. For clarity, UMLLC will only share in the liability for a University Claim to the extent related to its specific obligations under the Concession Agreement.
- (d) The Parties acknowledge that where this University Lease contemplates meetings between UMLLC and the University and/or any of their respective Representatives, such provisions generally do not necessarily contemplate a right for the Concessionaire to attend such meetings. The University and UMLLC will use reasonable efforts to ensure that the Concessionaire is included in such meetings and, where the University and UMLLC are not successful, the University and UMLLC each agrees to keep the Concessionaire informed of any such discussions or meetings between UMLLC and the University and to put forward all comments and questions provided to them by the Concessionaire in respect of the subject matter of the relevant discussions or meetings. The University and UMLLC will not agree on any matter at a meeting in which the Concessionaire is not present and which could impact the obligations of the Concessionaire under the Concession Agreement without the prior written consent of the Concessionaire.
- (e) In certain sections of this University Lease, there are references to or acknowledgements of the Concession Agreement or portions thereof and the absence of such a reference or acknowledgement in any other particular section of this University Lease will not be construed for or against either party in interpreting this University Lease.
- (f) Notwithstanding anything in this University Lease to the contrary, the University may, in its sole and absolute discretion: (i) pay, perform or otherwise satisfy any and all obligations of UMLLC to the Concessionaire under the Concession Agreement, as and when the same become due; (ii) collect, receive, settle or compromise any and all obligations of Concessionaire to UMLLC under the Concession Agreement, as and when the same become due; or (iii) direct or cause UMLLC to approve or reject any matter requiring UMLLC’s approval under the

Concession Agreement. UMLLC hereby irrevocably makes, constitutes, and appoints the University (and any officer of the University or any Person designated by the University for that purpose) as UMLLC's true and lawful proxy and attorney-in-fact (and agent-in-fact) in UMLLC's name, place, and stead, with full power of substitution, to carry out the foregoing purposes. UMLLC hereby acknowledges that the constitution and appointment of such proxy and attorney-in-fact are coupled with an interest and are irrevocable.

- (g) Notwithstanding anything contained in this University Lease to the contrary, and without limiting the provisions of Section 1.20(f) above, the Parties acknowledge and agree that (i) the University shall make any and all payments due from UMLLC to the Concessionaire under the Concession Agreement directly to the Concessionaire as and when the same become due from UMLLC to the Concessionaire pursuant to the terms of the Concession Agreement, and payment by the University of such amounts directly to the Concessionaire shall be in satisfaction of the University's corresponding payment obligation to UMLLC under this University Lease, and (ii) the Concessionaire shall make any and all payments due from the Concessionaire to UMLLC under the Concession Agreement directly to the University as and when the same become due from the Concessionaire to UMLLC pursuant to the terms of the Concession Agreement as provided in the Concession Agreement, and payment by the Concessionaire of such amounts directly to the University shall be in satisfaction of UMLLC's corresponding payment obligation to the University under this University Lease.
- (h) Notwithstanding anything contained in this University Lease to the contrary, the Parties acknowledge and agree that UMLLC may cause the Concessionaire, pursuant to the Concessionaire's obligations under the Concession Agreement, to perform any obligation of UMLLC to the University required under this University Lease, and performance by the Concessionaire of such obligations for the benefit of the University shall be in satisfaction of UMLLC's corresponding obligation to the University under this University Lease.

Section 1.21. Equivalent Project Relief.

- (a) Except to the extent any entitlement of UMLLC under this University Lease (including any rights, remedies or relief) does not, in any way, relate to the rights or obligations of the Concessionaire under the Concession Agreement, the Concessionaire will be entitled to receive the benefit of such entitlement from UMLLC (in accordance with and subject to the provisions of Section 1.21(c)), including the benefit of:
 - (i) any compensation, damages or other payment of any kind on the same or substantially the same grounds as UMLLC is entitled to compensation, damages or other payment of any kind under this University Lease, including compensation on termination;

- (ii) any other relief (including any extension of time) from the performance of its obligations under, or from termination of, the Concession Agreement on the same or substantially the same grounds as UMLLC is entitled to be relieved from performance of equivalent obligations under, or from termination of, this University Lease;
- (iii) any entitlement of the Concessionaire under the Concession Agreement in respect of which any provision of the Concession Agreement states that the Pass-Down Provisions are to apply; and
- (iv) any certificate, consent or approval granted under the Concession Agreement, this University Lease or any other agreement, statute, bylaw or regulation in regard to any matter relating to the Concessionaire, including any entitlement of UMLLC to request or apply for such certificate, consent or approval from the University, or any other Person under the Concession Agreement or this University Lease,

including, for greater certainty, any benefit to UMLLC arising out of any modification implemented or required because of a University Directive pursuant to this University Lease, any Compensation Event, Delay Event, Force Majeure, or remedies or compensation in respect of any University Default in respect of which UMLLC is entitled to relief, compensation or benefit under this University Lease in respect of UMLLC's obligations, but excluding any specific loss, cost or expense incurred by UMLLC to which the relevant compensation expressly relates and which is not included in any amount claimed by the Concessionaire.

UMLLC's entitlement under the Concession Agreement in respect of the matters set out in this Section 1.21 is referred to in this University Lease as "Equivalent Project Relief".

- (b) The Concessionaire will not be entitled to any relief from, or waiver in respect of performance of its obligations under the Concession Agreement other than:
 - (i) to the extent UMLLC receives Equivalent Project Relief under this University Lease; or
 - (ii) to the extent expressly provided for in the Concession Agreement.
- (c) The Concessionaire will be entitled to the benefit of any Equivalent Project Relief to the extent that UMLLC is or becomes entitled under this University Lease only if, when and to the same extent that UMLLC has received Equivalent Project Relief from the University under this University Lease.
- (d) For purposes of UMLLC asserting a claim under this University Lease against the University in respect of Equivalent Project Relief, where the Concessionaire has suffered Losses or otherwise claims relief in respect of any event or circumstance in respect of which UMLLC is entitled to claim Equivalent Project Relief, the University and UMLLC each acknowledges that UMLLC will be obligated to

include such Losses or relief claimed by the Concessionaire in UMLLC's claim against the University and to make such claim against the University under this University Lease, provided that the Concessionaire's recourse against UMLLC and UMLLC's liability to the Concessionaire in respect of any such Losses or relief will be subject to, and strictly limited by, the provisions of Sections 1.21(a) through 1.21(c) of the Concession Agreement and that UMLLC will not be required to reimburse the Concessionaire under the Concession Agreement to the extent that such Losses or relief arise as a result of any failure on the part of the University to perform its obligations under this University Lease, unless UMLLC has received compensation from the University under this University Lease in respect of such University failure, in which case the Pass-Down Provisions shall apply.

Section 1.22. Enforcement of Parallel Issues.

- (a) UMLLC will preserve, protect, and pursue under the Concession Agreement such rights, remedies, and relief as may relate to the University's rights and obligations hereunder, including any claim for Equivalent Project Relief, (a "Parallel Issue") in order to secure a favorable resolution of the Parallel Issue, provided that:
- (i) UMLLC has received written notice from the University of the Parallel Issue;
 - (ii) the University will not be entitled to recover from UMLLC any Losses or claims arising out of or in connection with UMLLC pursuing resolution of a Parallel Issue on the University's behalf other than any amounts received from the Concessionaire in respect of such Parallel Issue; and
 - (iii) the University will indemnify UMLLC in respect of any Losses arising out of or in connection with UMLLC pursuing resolution of a Parallel Issue on the University's behalf in accordance with this Section 1.22(a), including reimbursing UMLLC for any deduction from, reduction of or exercise of set-off, compensation or similar right against any amount payable by the Concessionaire associated therewith, provided that such indemnification will, unless UMLLC has no entitlement to any amount received in respect of such Parallel Issue, be proportionate to the ultimate entitlements of each party derived from pursuing resolution of such Parallel Issue.
- (b) Subject to Section 1.22(c), UMLLC consents to the University pursuing the rights, remedies and relief under the Concession Agreement described in Section 1.22(a) of this University Lease, including any entitlement to compensation on termination, in the name of UMLLC, which may, subject to the provisions of Section 12.4 of the Concession Agreement, include the defense of claims where the University is required to provide an indemnity to UMLLC in accordance with this University Lease. The University will be responsible for the cost and expense of pursuing such rights, remedies and relief, provided that, if the University is successful in pursuing any claim in respect thereof, such cost and expense will be allocated equitably between the Parties in proportion to their ultimate entitlements to same.

UMLLC will, at the sole cost and expense of the University, use commercially reasonable efforts to provide assistance, including providing documents, data, and information, as the University may reasonably request in connection with the pursuit of such Parallel Issue by the University.

- (c) No later than seven (7) days following receipt of the notice referred to in Section 1.22(a)(i), UMLLC may take conduct of the Parallel Issue and pursue the rights, remedies and relief under the Concession Agreement described in Section 1.22(a) of this University Lease on behalf of the University and in accordance with the reasonable directions of the University.
- (d) UMLLC will not enter into any compromise or settlement of a Parallel Issue with the Concessionaire which affects, in any respect, the University's obligations, rights, remedies or relief hereunder without the prior written consent of the University, in its sole discretion.
- (e) Where UMLLC pursues a Parallel Issue in accordance with this Section 1.22, the University will be kept informed of UMLLC's progress under this Section 1.22 and will be given the opportunity to comment on all submissions (written or oral) which are to be put forward by UMLLC in accordance with this Section 1.22.
- (f) The University will, at its own cost and within the time frame contemplated by any relevant dispute resolution procedure, use commercially reasonable efforts to provide assistance, including providing documents, data, and information, as UMLLC may reasonably request in connection with the pursuit of any Parallel Issue.
- (g) Any claims in respect of a Parallel Issue and any recoveries obtained by UMLLC or the University in respect of any Parallel Issue under the Concession Agreement will be subject to the provisions of Section 1.21 in respect of Equivalent Project Relief.

Section 1.23. Pass-Down Provisions. The Parties acknowledge and agree that all provisions of this University Lease including the provisions of each Schedule hereto will be subject to the provisions of Section 1.20 through Section 1.22 of this University Lease (the "Pass-Down Provisions"), and the absence of any specific reference to the Pass-Down Provisions will not preclude the application of the Pass-Down Provisions to any provision of this University Lease.

Section 1.24. Communications with the Concessionaire and Third Parties.

- (a) To the extent that any written notice, information, consent, claim, request, response, submission, or other communication (a "Communication") is required or permitted to be given or made by the University directly to the Concessionaire or any other third party under this University Lease or the Concession Agreement, the University will provide a copy of the same to UMLLC at the same time as giving or making the Communication to the Concessionaire or such third party.

- (b) Except as otherwise specifically set out in this University, UMLLC hereby gives permission to the University to provide all Communications directly to the Concessionaire.
- (c) UMLLC will make all Communications required to be made by UMLLC to the University under this University Lease in a timely manner so as to permit the University to comply with its obligations under this University Lease and will consult with the University in respect of all Communications with the Concessionaire.
- (d) The University will make all Communications required to be made by the University to UMLLC under this University Lease in a timely manner so as to permit UMLLC to comply with its obligations under this University Lease.

Section 1.25. Louisiana Defined Terms. As used in this University Lease, the term “lien” will also mean a privilege, mortgage, security interest, assignment, or other encumbrance. The term “real property” or “real estate” will mean “immovable property” as that term is used in the Louisiana Civil Code. The term “personal property” will mean “movable property” as that term is used in the Louisiana Civil Code. The terms “fee simple interest” shall mean “full ownership interest” as that term is used in Louisiana law. The term “easement” will mean “servitude” as that term is used in the Louisiana Civil Code. The term “building” will also include “other constructions” as that term is used in the Louisiana Civil Code. The term “intangible” will mean “incorporeal” as that term is used in Louisiana law. The term “tangible” will mean “corporeal” as that term is used in Louisiana law. The term “condemnation” will include “expropriation” as that term is used in Louisiana law. The term “receiver” will include “keeper” as that term is used in Louisiana law. The term “fixtures” will mean component parts of the Land and/or the improvements.

ARTICLE 2

THE TRANSACTION; CONDITIONS PRECEDENT; COVENANTS; ADMINISTRATIVE FEE

Section 2.1. Grant of Concession. Upon the terms and subject to the conditions of this University Lease, effective at the Time of Turnover:

- (a) The University demises and leases the Property to UMLLC free and clear of Encumbrances other than Permitted University Encumbrances and on an exclusive basis, other than as expressly provided in this University Lease and the Concession Agreement, for and during the term (the “Term”) commencing on the Turnover Date and expiring on the thirtieth (30th) anniversary thereof (or such later date as may be required to effect a Delay Event Remedy but subject to earlier termination as provided in this University Lease), provided that such demise and lease of the Utility Facilities and Utility System Assets other than those located on the Utility System Land shall not prevent the University or any Governmental Authority from using, occupying, developing, leasing, or otherwise enjoying the real property and the improvements other than the land on which the Utility Facilities and Utility

System Assets are located without the payment of any fee, charge or rent to UMLLC, and

- (b) The University (i) grants UMLLC a non-exclusive license during the Term, appurtenant to the leasehold interest described in clause (a) above, to access the Public Way and other portions of the University Campus (subject to Section 3.2(b)), solely in order to operate, maintain, repair, replace, improve, and service the Utility Facilities and Utility System Assets located therein or thereon to the extent permitted or required under this University Lease and the Concession Agreement, and (ii) grants UMLLC, free and clear of any Encumbrances (other than Permitted University Encumbrances) for and during the Term, except as expressly provided in this University Lease and the Concession Agreement (including as provided in Section 3.21 and Section 4.1), (x) an exclusive right to perform the Capital Improvements which are Approved pursuant to Section 4.3, (y) an exclusive right to design, build, and finance the Initial Modernization Project, subject to the University's approval rights as set forth herein, and (z) an exclusive right to operate the Utility System (and any expansions, improvements or replacements thereto) and to provide Utility Services on the University Campus (except as expressly provided herein or in the Concession Agreement), and in connection therewith (A) to use, possess, control, operate, manage, modify, maintain, and rehabilitate the Utility System; and (B) to charge the Utility Fee (collectively, the "Transaction").

Section 2.2. Turnover.

- (a) The commencement of the rights and obligations of the Parties hereunder (the "Turnover") shall occur on the date on which the Turnover occurs which date shall be the date hereof (the "Turnover Date"). The Turnover shall be held at the University, [●], Baton Rouge, Louisiana, or such other place agreed to in writing by the University and UMLLC.
- (b) All Prorated Items shall be prorated between the University and UMLLC as of 11:59 p.m. on the Day immediately preceding the Turnover Date based upon the actual number of Days in the month and a three hundred sixty-five (365) -Day year and the required payment resulting from such proration shall be made by the relevant Party to the other as follows:
 - (i) On or prior to the Time of Turnover, the University will provide to UMLLC an itemized statement of such Prorated Items, estimated in good faith as of the Turnover and reasonably based on relevant billing information from third parties or (in the absence of such information) the University's financial statements as of [●], and such statement shall be the basis of proration of any Prorated Items at the Time of Turnover;
 - (ii) Within forty-five (45) Business Days after the Turnover, the University will provide to UMLLC a revised good-faith accounting of such Prorated Items as of the Turnover in the form of an itemized statement of such Prorated Items (the "Revised Proration Statement");

- (iii) Within fifteen (15) Business Days after UMLLC's receipt of the Revised Proration Statement, UMLLC will review the Revised Proration Statement and will notify the University of any adjustments made by UMLLC to the Revised Proration Statement in good faith;
 - (iv) To the extent the University disagrees with any of UMLLC's adjustments to the Revised Proration Statement, the University shall provide notice to UMLLC within fifteen (15) Business Days after the University's receipt of UMLLC's adjustments, and any disagreement shall be resolved in accordance with Article 18; and
 - (v) Upon final resolution with respect to the proration of each such Prorated Item (whether by agreement of the Parties or in accordance with Article 18), the Party that is determined to owe money pursuant to the proration of that Prorated Item shall pay to the other party the amount owed within ten (10) Business Days of such determination.
- (c) At the time of the first closing of the financing of the Initial Modernization Project, UMLLC shall pay to the University in readily available funds (according to instructions provided by the University to the Concessionaire not later than three (3) Days prior to such closing) an amount equal to the University Reimbursable Amount.

Section 2.3. Conditions Precedent to Turnover.

- (a) *Conditions for the Benefit of UMLLC.* UMLLC shall be obligated to complete the Turnover only if each of the following conditions has been satisfied in full at or before the Time of Turnover, unless waived by UMLLC:
- (i) the representations and warranties of the University set forth in Section 9.1 shall be true and correct in all material respects as of the Time of Turnover;
 - (ii) The University shall have (A) delivered to UMLLC a legal opinion of counsel to the University, substantially in the form attached hereto as Schedule 8A, and (B) executed and delivered the Employee Services Agreement in the form of Schedule 4B (which shall also have been executed by UMLLC);
 - (iii) all Campus-Wide Permits set forth on Schedule 18 are in full force and effect;
 - (iv) the University shall have obtained and delivered to UMLLC, at the expense of UMLLC, a commitment effective at the Time of Turnover for a leasehold title policy or policies, in form and substance reasonably acceptable to UMLLC (which will include an endorsement with the terms of the leasehold coverage), proposing to insure the leasehold interest of UMLLC in the Utility System Land, to the extent of such leasehold interest, subject only to (A) Permitted UMLLC Encumbrances, (B) Permitted Concessionaire

Encumbrances (other than the Permitted Concessionaire Encumbrances specified in clause (iv), clause (vii), and clause (ix) of the definition of “Permitted Concessionaire Encumbrances” as it pertains to clause (iv) of this Section 2.3(a)) and (C) any Encumbrances the Concessionaire is required to remove pursuant to Section 3.5(a) (the “Title Commitment”) from the Title Company, from which Title Company UMLLC shall purchase any leasehold title insurance policies (or any other title policies related to the Transaction) that it elects to purchase at UMLLC’s cost in connection with the Transaction or any Leasehold Mortgage; and

- (v) The University shall have delivered to UMLLC a certificate confirming that each of the conditions set forth in Section 2.3(a)(i) through Section 2.3(a)(iv) has been satisfied in full by the University (except for any condition that has been waived by UMLLC) at or before the Time of Turnover.
- (b) *Conditions for the Benefit of the University.* The University shall be obligated to complete the Turnover only if all of the conditions set forth in Section 2.3 of the Concession Agreement have been satisfied in full at or before the Time of Turnover, unless waived by the University.
- (c) *Mutual Conditions.* In addition, the University and UMLLC shall be obligated to complete the Turnover only if each of the following conditions precedent has been satisfied in full at the Time of Turnover, unless waived by both the University and UMLLC:
 - (i) there shall be no preliminary or permanent injunction or temporary restraining order or other order issued by a Governmental Authority of competent jurisdiction or other legal restraint or prohibition enjoining or preventing the consummation of the Transaction;
 - (ii) there shall be no action taken, or any Law enacted, entered, enforced or deemed applicable to the Transaction by any Governmental Authority of competent jurisdiction that, in any such case, has resulted or (in the case of any pending review or proceeding, if adversely determined) could reasonably be expected to result in such Governmental Authority conditioning or restricting the consummation of the Transaction in a manner that would impose a material impairment on the Transaction or make the consummation of the Transaction illegal; and
 - (iii) the University and UMLLC shall have approved in writing the Preliminary Design for the Initial Modernization Project in the form of Schedule 7.

Section 2.4. Covenants.

- (a) *Cooperation.* The Parties shall cooperate with each other in consummate the Transaction as provided in this University Lease.

- (b) *Reasonable Efforts.* Each Party shall use all reasonable efforts (i) to take, or cause to be taken, all actions necessary to comply promptly with all requirements under this University Lease and all legal requirements which may be imposed on such Party to consummate the Transaction as promptly as practicable, including making any necessary filings, and (ii) to obtain (and to cooperate with the other Party to obtain) any Consent of any Governmental Authority or any other public or private third party which is required to be obtained or made by such Party in connection with the consummation of the Transaction. Each Party shall promptly cooperate with and promptly furnish information to the other Party at such other Party's reasonable request in connection with any such efforts by, or requirement imposed upon, any of them in connection with the foregoing.
- (c) *Injunctions.* If any Governmental Authority of competent jurisdiction issues a preliminary or permanent injunction or temporary restraining order or other order which would prohibit or materially restrict or hinder the Transaction, each Party shall use all reasonable efforts to have such injunction, decree or order dissolved or otherwise eliminated or to eliminate the condition that formed the basis for such injunction or order, in each case as promptly as possible.
- (d) *Operation of the Utility System After the Time of Turnover.* UMMLC shall be fully responsible for performing the Utility Services under the terms of this University Lease, and for observing and performing all other obligations of UMMLC hereunder, from and after the Time of Turnover.
- (e) *Access to Information and Inspections.* UMMLC shall hold and shall cause its Representatives to hold in strict confidence all Documents and information concerning the Utility System to the extent and in accordance with the terms and conditions of the confidentiality agreement between the University and UMMLC in connection with the Transaction. UMMLC shall, at the request of the University, in connection with claims or actions brought by or against third parties based upon events or circumstances concerning the Utility System, (A) provide reasonable assistance in the collection of information or Documents and (B) make UMMLC's employees available when reasonably requested by the University; *provided, however,* that the University shall reimburse UMMLC for all out-of-pocket and documented costs and expenses incurred by UMMLC in providing said assistance and will not unduly interfere with UMMLC's operations.
- (f) *Final Design of Initial Modernization Project; Approved Budgeted Amount.* As quickly and efficiently as reasonably possible after the date hereof, the Parties shall cooperate and work collaboratively with each other and the Concessionaire to develop and approve (x) the Final Design of the Initial Modernization Project based on the Preliminary Design and (y) the proposed Approved Budgeted Amount for the Initial Modernization Project (which shall include the University Reimbursable Amount plus the Concessionaire Cost of Finance); *provided* the proposed Approved Budgeted Amount for the Initial Modernization Project shall not exceed [(\$111,880,557)] (such amount, plus the Concessionaire Cost of Finance, the "Maximum Budgeted IMP Amount"). UMMLC shall have the right to request

Approval of the Final Design and the Approved Budgeted Amount for the Initial Modernization Project at any time, which the University shall consider in good faith, by submitting a request to the University, or an office or person designated by the University Liaison, containing detailed plans for the Final Design and the proposed Approved Budgeted Amount based on such detailed plans, which shall include, in addition to such other commercially reasonable detail as the University shall require (which may include, at the University's discretion, such information and detail as contemplated by Section 4.3 below as if the Initial Modernization Project were a Capital Improvement or Material Change contemplated thereby): (A) total costs for construction and installation of the Initial Modernization Project, including all hard and soft costs, any financing costs, and any applicable sales or use tax, which shall be presented on an Open Book Basis; (B) an explanation of all relevant assumptions, variables, and data sources used to develop the proposed Final Design and the proposed Approved Budgeted Amount; and (C) the proposed schedules, process, and other technical and logistics details associated with the proposed Final Design and the proposed Approved Budgeted Amount. Upon receipt of UMLLC's request for approval of the Final Design and the Approved Budgeted Amount for the Initial Modernization Project, including all supporting information and detail therefor as described in this Section 2.4(f), the University shall review such request and, in its discretion:

- (i) Approve such request in accordance with the terms of such request after having undertaken all such necessary action and secured all authorizations, consents, and approvals required to be obtained by the University with respect to such Approval at such time, unless UMLLC's written request submitted to the University explicitly requested that the University respond only pursuant to Sections 2.4(f)(ii) or (iii);
- (ii) provide a written response requiring that UMLLC (1) perform additional work with respect to such proposed Final Design to provide further information regarding the scope, design, or cost thereof and/or multiple alternative designs therefor to the University, which additional work may include procuring any details contemplated by this Section 2.4(f) that were previously unavailable, and (2) after performing such additional work, submit a revised request for Approval by the University pursuant to this Section 2.4(f), which revised request the University shall consider; or
- (iii) (1) provide UMLLC with comments on such proposed Final Design or such proposed Approved Budgeted Amount, as applicable, including comments on any details provided in UMLLC's proposal, and (2) require that UMLLC incorporate such comments and re-submit a revised request for Approval pursuant to this Section 2.4(f).

The foregoing submittal and approval process shall continue until such time as the proposed Final Design and the proposed Approved Budgeted Amount has been Approved in accordance with Section 2.4(f)(i) above. Following the University's approval of the proposed Approved Budgeted Amount in accordance with this

Section 2.4(f), such amount shall constitute the Approved Budgeted Amount for the Initial Modernization Project, for purposes of this University Lease and the Concession Agreement, including the calculation of the Utility Fee.

- (g) *Policies of Insurance.* The University and UMLLC shall be responsible for obtaining insurance for the Utility System in accordance with the terms hereof.
- (h) *Employees.* The University and UMLLC shall comply with the terms and conditions of Section 2.4(h) of the Concession Agreement in all respects, the terms and conditions of which are integral to, and made part of, this University Lease.
- (i) *Excluded Utility System Projects.* The University shall undertake the construction of the Excluded Utility System Projects, in accordance with applicable Law, until they have been completed in substantial accordance with the plans for such Excluded Utility System Projects, provided that the University may, upon written notice to UMLLC, abandon or modify any or all Excluded Utility System Projects. To the extent that the construction or completion of any Excluded Utility System Project requires access to the Utility System, UMLLC hereby grants a non-exclusive license to the University and its Representatives to so access the Utility System as necessary to complete such Excluded Utility System Projects (and UMLLC shall use reasonable efforts to avoid undue interference with the operation of the Utility System) and shall reasonably cooperate with the University and its Representatives with respect to the completion of the Excluded Utility System Projects, which cooperation shall include (i) providing the University with notice if UMLLC becomes aware of any deviation from the University's approved plans and specifications for the applicable Excluded Utility System Project and (ii) directing the University's contractors to stop any work on the Excluded Utility System Project if UMLLC reasonably believes that continuing such work would constitute an Emergency. Upon completion of an Excluded Utility System Project, the University shall (i) deliver UMLLC written notice thereof, and, at such time, that Excluded Utility System Project shall become part of the Utility System and UMLLC shall be granted a leasehold interest therein, (ii) either (A) assign to UMLLC (or one or more third parties at UMLLC's direction,) all contractors' warranties held by the University with respect to such Excluded Utility System Project or (B) to the extent the University chooses not to so assign such warranties or such warranties are not assignable, cooperate with UMLLC to provide the benefit of such warranties to UMLLC (or one or more third parties at UMLLC's direction), and (iii) the Capped O&M Amount shall be increased for the Fiscal Year in which such Excluded Utility System Project is placed into service by the additional annual operation and maintenance costs (determined reasonably in accordance with GAAP) that UMLLC is required to incur due to the placement into service of such Excluded Utility System Project, provided that UMLLC provides reasonable proof of such additional costs and that such additional costs were unavoidable. The University shall name UMLLC as an additional insured on its insurance policies with respect to those Excluded Utility System Projects. For the avoidance of doubt, Excluded Utility System Projects shall not be considered New Approved Capital Improvements. If the University elects to abandon an Excluded Utility System

Project, the Capped O&M Amount shall be increased for the Fiscal Year in which such Capital Improvement is abandoned by the additional annual operation and maintenance costs (determined reasonably in accordance with GAAP) that UMLLC is required to incur due to the abandonment of such Excluded Utility System Project, provided UMLLC provides reasonable proof of such additional costs and that such additional costs were unavoidable.

Section 2.5. Turnover Deliverables. At the Time of Turnover, each Party shall execute and deliver all assets, agreements, endorsements, instruments, and Documents as are reasonably necessary in the opinion of the other Party to effect the Transaction (and in form and substance that are reasonably satisfactory to such other Party).

Section 2.6. Memorandum of University Lease. At the Time of Turnover, the Parties shall execute and deliver a Memorandum of University Lease (the “Memorandum of University Lease”) in the form attached hereto as Schedule 13, which the Parties shall cause to be recorded in the Recorder’s Office of the East Baton Rouge Parish, Louisiana. To the extent that changes are made to this University Lease with respect to the Term, leased property or other material matters set forth in the recorded Memorandum of Material Lease, including the removal of property from service by the Utility System in accordance with Section 5.3, the Parties shall timely (and in no event longer than 10 Days after a request therefor) execute, deliver and record an amendment to the recorded Memorandum of University Lease reflecting such changes. The Parties acknowledge that for purposes of recordation, a description of certain portions of the Utility System constituting Utility Facilities that are a real property interest, are depicted specifically but are recorded generally against the lot or parcel on which such Utility Facility is located. Each party shall have the right, from time to time, at its cost and expense to further refine by a metes and bounds legal description the specific location of the applicable Utility Facility, and subject to the other Parties’ reasonable approval, may modify the Memorandum of University Lease by recording an amendment thereto that shows the refined location description. In such instance, the modification to the Memorandum of University Lease is subject to the other Party’s reasonable approval, and both Parties shall sign a consent to the recording of the Memorandum of University Lease upon its approval. The Parties agree not to record this University Lease itself.

Section 2.7. Administrative Fee. During the Term, the University shall pay UMLLC an annual administrative fee in the amount of Seven Thousand Five Hundred and No/100 Dollars (\$7,500.00) for the reimbursement UMLLC’s costs and expenses related to the Transaction, which, notwithstanding anything herein to the contrary, (i) shall in no event be considered part of the Utility Fee, (ii) shall be retained by UMLLC for its own account and (iii) shall not be payable by UMLLC to the Concessionaire under the Concession Agreement.

ARTICLE 3 TERMS OF THE CONCESSION

Section 3.1. Quiet Enjoyment and Present Condition.

- (a) *Quiet Enjoyment.* The University agrees that, subject to the University’s remedies upon a UMLLC Default, UMLLC shall, at all times during the Term, be entitled to and shall have quiet enjoyment of the Utility System and the rights and privileges

granted to UMLLC hereunder, subject to the provisions contained in this University Lease. The University and UMLLC acknowledge that UMLLC's rights to use, control, and possess the Utility System and to collect and retain the Utility Fee are subject to the right of the University, in accordance with the terms of this University Lease, to monitor compliance with this University Lease to ensure that the Utility System is used and operated as required by this University Lease. Any entry by the University or its Representatives into the Utility System required or permitted under this University Lease shall not constitute a reentry, trespass, or a breach of the covenant for quiet enjoyment contained in this University Lease. The University shall, at all times during the Term, defend its fee or leasehold interest title, as the case may be, to the Utility System, UMLLC's leasehold interest in and to the Utility System and the rights granted to UMLLC hereunder, or any portion thereof, against any Person claiming any interest adverse to the University or UMLLC in the Utility System, or any portion thereof, except where such adverse interest arises as a result of the act, omission, negligence, or willful misconduct of, or violation of applicable Law by, UMLLC, its Affiliates or their respective Representatives.

- (b) *Present Condition.* Subject to Section 2.4(g) and except as specifically set forth herein, UMLLC understands, agrees, and acknowledges that UMLLC (i) by the execution of this University Lease, agrees to accept the Utility System "AS IS" at the Time of Turnover and (ii) has inspected the Utility System and is aware of its condition and acknowledges that the University neither has made nor is making any representation or warranty, other than as expressly set forth herein, express or implied, regarding the condition of the Utility System (or any part thereof), the absence of latent or apparent defects in the Utility System (or any part thereof), or its suitability for UMLLC's proposed use, provided that nothing in this Section 3.1(b) shall preclude UMLLC from making repairs or replacements or Capital Improvements to the Utility System in accordance with the terms of this University Lease (including, for the avoidance of doubt, the provisions regarding Approval of Capital Improvements set forth in Section 4.3 and the provisions regarding inclusion of New Approved Capital Improvements and operations and maintenance costs (reasonably determined in accordance with GAAP) in the calculation of the Utility Fee in accordance with Schedule 5) as a result of the Utility System's condition at the Time of Turnover. Upon the Turnover, UMLLC shall be deemed to have inspected and shall assume responsibility for the condition of the Utility System consistent with provisions of La R.S. 9:3221.
- (c) *Legal Title to Real Property and Improvements.* For the avoidance of doubt, and notwithstanding anything to the contrary contained herein, all real estate and improvements now or hereafter forming part of the Utility System shall be the fee-owned property of the University for GAAP and State law purposes, and are subject to the terms and conditions of this University Lease.

Section 3.2. Utility System Operations.

- (a) *Use.* Except as otherwise specifically provided herein, UMLLC shall, at all times during the Term, (i) be responsible for all aspects of the Utility System Operations,

including providing the Utilities from temporary sources for construction projects and special events as identified by the University and (ii) maintain and operate the Utility System and cause the Utility System Operations to be performed in accordance with the provisions of this University Lease, including the Performance Standards, Prudent Industry Practices, and applicable Law. Upon the University's request, UMLLC shall provide an estimate for the costs associated with providing Utilities from temporary sources for construction projects or special events identified by the University. In connection with such maintenance, UMLLC may contract with a third party for certain tasks, such as janitorial services. Except for such additional purposes permitted pursuant to Section 3.15(c), UMLLC shall, at all times during the Term, cause the Utility System to be used exclusively for the Utility System Purposes and continuously open and operational for the Utility System Purposes in accordance with the Performance Standards. Notwithstanding the foregoing, UMLLC may cease keeping the Utility System or a portion thereof continuously open and operational for the Utility System Purposes (A) as specifically permitted under this University Lease, (B) as required by applicable Law, (C) as necessary to comply with any other requirement of this University Lease (including closures related to the performance of Capital Improvements or maintenance or repair activities as required by the Performance Standards), (D) as necessary for a Delay Event, or (E) as necessary for temporary closures required to address Emergencies or public safety; provided, however, that in the event of any temporary suspension of Utility System Operations pursuant to any of clauses (A) through (E) of this Section 3.2(a), such suspension shall be limited as much as practicable so as to allow all other Utility System Operations to continue.

- (b) *University Campus.* Notwithstanding anything to the contrary contained herein, UMLLC shall operate the Utility System and provide the Utility Services in a manner that does not interfere with or impair the operation of the University Campus or any other real property owned by the University, including any special events conducted on the University Campus. Except in the case of an Emergency or as otherwise provided for in Section 3.2(e) or Section 3.2(j), if UMLLC, in performing the Utility System Operations, determines it is reasonably necessary to access or disturb any portion of the University Campus or any other real property owned by the University, excluding Utility System Land, it shall, to the extent possible given the circumstances, provide the University at least thirty (30) Days' prior written notice and UMLLC shall comply with any reasonable requirements or restrictions on such disturbance imposed by the University, including limiting the time in which UMLLC can so access and/or disturb the portion of the University Campus or any other real property owned by the University to specific hours. In accessing any portion of the University Campus or any other real property owned by the University pursuant to the license granted hereunder, UMLLC shall also abide by any restrictions and requirements generally imposed by the University on such access, as communicated to UMLLC from time to time. To the extent that, in operating and maintaining the Utility System, UMLLC damages any portion of the University's real or personal property, including the landscape of the University Campus, the University's information technology network or any other real property owned by the University, the University's outdoor lighting, traffic signals,

irrigation equipment and communications equipment and such damage was neither (i) Approved by the University in accordance with this University Lease nor (ii) included as part of the scope of work Approved by the University related to such operations and maintenance, then UMLLC shall, in coordination with University personnel, promptly cause such property to be repaired to substantially the same or, solely at UMLLC's election, better condition that existed prior to such damage, and the cost incurred therewith shall not be recovered as a part of the Utility Fee or otherwise provided, however, that UMLLC shall be entitled to make a claim on any applicable UMLLC Required Coverage.

- (c) *Costs and Expenses.* Except as otherwise specifically provided herein, UMLLC shall, at all times during the Term, pay or cause to be paid all costs and expenses of the Utility System Operations as and when the same are due and payable.
- (d) *Assumed Liabilities and Excluded Liabilities.* UMLLC agrees to assume and discharge or perform when due all debts, liabilities, and obligations whatsoever relating to the Utility System or the Utility System Operations that occur, arise out of or relate to, or are based on facts or actions occurring during the Term but only to the extent such debts, liabilities, or obligations do not arise from or relate to any breach by the University of any covenant, representation, or warranty set forth in this University Lease (collectively, the "Assumed Liabilities"); *provided, however,* that the Assumed Liabilities shall not include, and the University shall perform or cause to be performed and discharge or cause to be discharged as and when due, any debts, liabilities, and obligations (i) with respect to the University's obligations under this University Lease, (ii) arising out of the Utility System or any Utility System Operations (including with respect to any Utility System Employee) prior to the Time of Turnover, (iii) arising under any Environmental Law and related to (1) the ownership, operation or condition of the Utility System prior to the Time of Turnover or (2) the Release on or from, presence on or in, or other existence on the Utility System or its subsurface of any Hazardous Substance at any time prior to the Time of Turnover and including (A) the abatement, handling, disposal, or removal of any asbestos or other Hazardous Substances present at the Time of Turnover in the Utility System as required by any Environmental Law in connection with the repair, maintenance, operation, or construction activities permitted or required to be performed under this University Lease and (B) any known or unknown environmental conditions relating to the Utility System or its subsurface that existed prior to the Time of Turnover the manifestation of which occurs following the Time of Turnover, which environmental obligations the University shall perform and discharge when due, except in any case to the extent exacerbated by UMLLC or its Representatives or caused by any action of UMLLC or its Representatives, (iv) arising out of the University's rights under this University Lease to test, inspect, audit, repair, maintain, or operate the Utility System without impairment of the University's remedies for a UMLLC Default and (v) with respect to the Excluded Utility System Projects that have not yet become a part of the Utility System in accordance herewith (collectively, the "Excluded Liabilities").

- (e) *Right of Entry and Access to the Public Way.* Subject to Section 3.19, the University hereby grants to UMLLC and its Representatives a non-exclusive license to enter upon, in, under, over, and across the Public Way to such extent and at such times as shall be necessary or desirable for UMLLC to access the Utility System in order to conduct Utility System Operations, including operating, maintaining, inspecting, repairing, and managing Utility System properties, including the Utility System Assets and all supporting structures and appurtenances thereto, and installing monitoring or observation technology or equipment reasonably necessary for Utility System Operations. The rights granted pursuant to this Section 3.2(e) do not include the right to block, impede, or otherwise obstruct traffic on the Public Way, and UMLLC shall, enter, access, and perform work in, on or over the Public Way in accordance with the Performance Standards. The rights granted to UMLLC under this Section 3.2(e) neither create an interest in real property nor do they create a priority in favor of UMLLC over any other user of such areas and are subject to the Performance Standards and all provisions of Law relating to the conduct of a private business or franchise in the Public Way.
- (f) *Mapping and Marking.* UMLLC shall be responsible for marking and mapping all portions of the Utility System in accordance with the Performance Standards.
- (g) *Deemed Planned Outage.* UMLLC shall have the right to propose to shut down a portion of the Utility System such that such portion shall not transmit Utilities provided by that portion of the Utility System if UMLLC reasonably believes that such a shutdown will avoid additional costs in excess of the costs of such shutdown or lengthier shutdowns of the Utility System or a portion thereof later. If the University Liaison agrees to such shut down (which agreement must be in writing or by e-mail from the University Liaison), then it shall be treated as a Planned Outage. The University Liaison shall consider such proposed shut down in good faith. If the University Liaison does not Approve such shutdown, then it will be considered an Unplanned Outage if UMLLC elects to proceed with such shutdown.
- (h) *Emergency Shutdown.* If there is a circumstance where the continued operation of a portion of the Utility System creates an Emergency (other than an Unplanned Outage), then UMLLC shall have the right, directly or through its automatic protection system or the Operator, to shut down the applicable portion of the Utility System to address such circumstance, provided that UMLLC shall comply with the provisions of Section 8.1 and the relevant portion of the Performance Standards, as if such shutdown were an Unplanned Outage. UMLLC shall perform the corrective action to address such circumstance as soon as reasonably practicable. Within ten (10) Business Days after the shutdown and repair of the applicable portion of the Utility System, UMLLC shall provide the University with pertinent information on such circumstance and such other relevant information within UMLLC's possession or control that is requested by the University, and the University shall determine, in its reasonable judgment, whether such shutdown shall constitute an Unplanned Outage for purposes of determining the applicable Key Performance Indicator. For the avoidance of doubt, such determination shall not affect

UMLLC's obligation to treat such shutdown as an Unplanned Outage for purposes of compliance with the Performance Standards.

- (i) *Other Public Streets.* To the extent that the performance of the Utility System Operations requires access to streets, alleys, driveways, or sidewalks owned or controlled by a Governmental Authority, the University shall, at no out-of-pocket cost to the University, use commercially reasonable efforts to cooperate with UMLLC to secure such access from the applicable Governmental Authority consistent with the University's past practice.

Section 3.3. Operator.

- (a) *Engagement.* The Utility System Operations shall, at all times during the Term, be under the direction and supervision of an active operator with the expertise, qualifications, experience, competence, skills, and know-how to perform the Utility System Operations in accordance with this University Lease, Prudent Industry Practices and applicable Law (an "Operator") who may be (but is not required to be) UMLLC or the Concessionaire itself. The Operator on the first Day of the Term shall be [CenTrio Energy South LLC] unless UMLLC has designated another Person to be the Operator and such Person has been Approved in accordance with Section 3.3(b). UMLLC shall not engage or appoint a replacement Operator unless the University has Approved such Operator and the terms (including fees charged by such replacement Operator) of any such engagement are commercially reasonable; *provided, however*, that a "Change in Control" (as such term is defined and used in the Concession Agreement) of an Operator shall be deemed to be the appointment of a replacement Operator subject to the University's Approval; *provided, further*, that for purposes of this Section 3.3(a), the definition of "Equity Participant" and clauses (a) through (g) of the definition of "Change in Control" as set forth in the Concession Agreement shall be read and apply as though "Operator" were substituted for the "Concessionaire"; *provided, further*, that if the University does not provide UMLLC with the relevant Approval, UMLLC shall be entitled to appoint an interim Operator for a period of up to one hundred eighty (180) Days from the date of appointment of such interim Operator. This interim Operator may be selected without Approval by the University so long as UMLLC reasonably determines that the interim Operator meets the following criteria: (A) the interim Operator has experience in operating Comparable Utility Systems and (B) the interim Operator (or any guarantor of its obligations) has a tangible net worth reasonably sufficient to carry out its obligations and responsibilities as Operator. UMLLC shall not extend the term of any interim Operator beyond one hundred eighty (180) consecutive Days or appoint a successor interim Operator after such one hundred eighty (180) -Day period. The Operator shall at all times be subject to the direction, supervision, and control (by ownership, contract, or otherwise) of UMLLC, and any delegation to an Operator shall not relieve UMLLC of any obligations, duties or liability hereunder. UMLLC shall immediately notify the University upon the termination or resignation of an Operator. The rights of the Operator regarding the continued operation of the Utility System shall terminate without penalty at the election of the University or the Operator upon five (5)

Business Days' notice to such Operator or the University, as applicable, upon the termination of this University Lease. Except as otherwise expressly set forth herein, the Operator shall have no interest in, or rights under, this University Lease or the Utility System unless the Operator is UMLLC or the Concessionaire itself.

(b) *Approval.* The University has the right, acting reasonably, to withhold Approval of any removal of the Operator or a proposed replacement Operator, including for any of the following reasons: (i) the University reasonably determines that the engagement of such proposed Operator is prohibited by applicable Law or this University Lease; or (ii) the University reasonably determines that such proposed Operator is not capable of performing the Utility System Operations in accordance with this University Lease and Prudent Industry Practices, which determination may be based upon one or more of the following factors: (A) the ability of the proposed Operator to operate the Utility System in a manner that complies with the Performance Standards; (B) the financial strength, capitalization, and integrity of the proposed Operator, its direct or indirect beneficial owners and some or all of their respective Affiliates providing a guaranty of the Operator's obligations (which guaranty shall not be required to run to the benefit of the University); (C) the experience of the proposed Operator in operating Comparable Utility Systems; (D) the background and reputation of the proposed Operator, its direct or indirect beneficial owners, each of their respective officers, directors and employees and each of their respective Affiliates (including the absence of criminal, civil or regulatory claims or actions against any such Person and the quality of any such Person's past or present performance on other projects); and (E) the proposed terms of the engagement of the proposed Operator, including the fee being charged by the Operator, length of the term of the engagement and any restrictions on transfer by the Operator of its obligations and change in control of the proposed Operator.

(c) *Removal.*

(i) If the Operator fails to operate the Utility System in compliance with the Performance Standards or fails to meet the Target for any Key Performance Indicator, and:

(A) If such failure is the material breach of a material requirement of the Performance Standards other than a requirement that is also a Key Performance Indicator, the University may provide written notice to the Operator and UMLLC setting forth such failure. If the Operator does not cure such failure within thirty (30) Days of said written notice (or, if such cure or correction cannot reasonably be accomplished during such thirty (30) -Day period, within such longer period is as reasonably required to accomplish such cure or correction, provided UMLLC, either directly or through the Operator, has commenced such cure or correction within thirty (30) Days of said written notice and diligently prosecutes the same to completion), then (i) the University may, upon notice to UMLLC (A) cure such failure and (B) UMLLC shall reimburse the University any and all costs related to such cure and/or correction; and (ii) the University may

direct that UMLLC remove the Operator pursuant to the written order of senior the University officials designated by the President of the University (or his or her designee) in writing for such purpose or otherwise with respect to assessing the performance of the Operator (the “Senior Officials”).

(B) If such failure results in an Emergency, then the University may, upon notice to UMLLC, (i) immediately cure any such failure after endeavoring to provide UMLLC notice appropriate under the circumstances (which may include telephone notice) and (ii) UMLLC shall reimburse the University any and all direct costs related to such cure and/or correction.

(ii) Notwithstanding the foregoing, if:

(A) within any Operator Evaluation Period, at least three (3) Repetitive Failures occur;

(B) a Major KPI Event for the same Key Performance Indicator occurs for five (5) consecutive Fiscal Years;

(C) five (5) Major KPI Events occur in any given Fiscal Year; or

(D) the amount of KPI Compensation (such amount to be calculated without regard to any reduction in KPI Compensation pursuant to Section 15.5(e) or Section 12.11(a)) incurred by UMLLC equals or exceeds the maximum amount of annual KPI Compensation for which UMLLC may be liable in accordance with Section 15.5 in any two (2) Fiscal Years out of any five (5) consecutive Fiscal Years,

then, in addition to its right to KPI Compensation, the University may direct that UMLLC remove the Operator pursuant to the written order of the Senior Officials.

(iii) The University shall provide UMLLC and the Operator with no less than thirty (30) Days’ prior written notice of the time, date, place, and subject matter of any meeting of the Senior Officials at which a decision to remove the Operator will be considered, and both UMLLC and the Operator shall be afforded a reasonable opportunity to present testimony and evidence at such meeting and to present to the Senior Officials written objections to any proposed removal determination. Any written order of the Senior Officials removing the Operator shall contain written determinations as to the reasons for removal of the Operator. Within thirty (30) Days following the effective date of such decision, UMLLC shall (x) provide the University with a transition plan to remove the then current Operator and replace such Operator with either (A) a new Operator that is Approved by the University pursuant to Section 3.3(b), (B) an interim Operator in accordance with Section 3.3(a) or (C) to the extent the Concessionaire was not the removed

Operator, the Concessionaire, and then (y) carry out such transition plan within 30 Days following the delivery thereof.

- (iv) For the avoidance of doubt, if there is a dispute as to whether there has been a failure to meet the Performance Standards or the Target for any Key Performance Indicator, such dispute shall be subject to resolution in accordance with Article 18.
- (d) *Sole Remedy*. Other than the University's right to KPI Compensation pursuant to Article 15, notwithstanding anything to the contrary contained herein, the University's right to remove the Operator pursuant to Section 3.3(c) shall constitute UMLLC's sole and exclusive liability and the University's sole and exclusive remedy relating to a failure to meet a requirement of the Performance Standards or a KPI Event.

Section 3.4. Authorizations; Qualifications.

- (a) *Compliance*. UMLLC shall obtain, comply with, promptly renew and maintain in good standing all Authorizations, and the University shall use commercially reasonable efforts to assist UMLLC in obtaining, complying with, renewing, and maintaining in good standing all such Authorizations, including those that the University was not required to obtain in connection with its operation of the Utility System prior to the Time of Turnover. If the University reasonably expects to incur any out-of-pocket costs in connection with providing assistance to UMLLC as provided in the preceding sentence, it shall have no obligation to provide such assistance until UMLLC commits to the prompt reimbursement of such out-of-pocket costs in writing. Nothing in this University Lease, including Section 2.1, shall be deemed to waive or modify any Authorization required to be obtained by UMLLC or any other Person in connection with the Utility System, the Utility System Operations, or any activities generating the Utility Fee.
- (b) *Qualifications*. UMLLC shall, at all times during the Term, maintain in full force and effect its existence and all qualifications necessary to carry on its business pertaining to the Utility System Operations, including all rights, franchises, licenses, privileges, and qualifications required in connection with the Utility System Operations.

Section 3.5. No Encumbrances.

- (a) *By UMLLC*. UMLLC shall not do any act or thing that will create any Encumbrance (other than a Permitted UMLLC Encumbrance) against the Utility System and shall promptly remove any Encumbrance (other than a Permitted UMLLC Encumbrance) against the Utility System, unless the Encumbrance came into existence as a result of an act of or omission by University, or a Person claiming through the University which in turn was not caused by an act or omission of UMLLC. UMLLC shall not be deemed to be in default hereunder if UMLLC continuously, diligently and in good faith contests any such Encumbrance, or the

validity thereof (or causes such contest), by appropriate legal proceedings that shall operate to prevent the foreclosure of any such Encumbrance; provided that UMLLC has (i) given advance notification to the University that it is the intent of UMLLC to contest the validity or collection thereof or cause such contest and (ii) unless a bond or other security is provided in connection with such proceedings, given a satisfactory indemnity to the University or deposited with the University a Letter of Credit, indemnity bond, surety bond, cash, or Eligible Investment reasonably satisfactory to the University in an amount equal to the amount of the claim or Encumbrance, plus such interest and penalties, court costs, or other charges as the University may reasonably estimate to be payable by UMLLC at the conclusion of such contest or as is required to provide insurance over any potential Encumbrance; *provided, however*, that unless UMLLC is required by GAAP to maintain any security in favor of a purported beneficiary of such Encumbrance, in the event such Letter of Credit bond, cash or Eligible Investment shall be so deposited, the same shall be held by the University until such claim or other imposition shall have been released and discharged and shall thereupon be promptly returned to UMLLC, less any amounts reasonably expended by the University to procure such release or discharge or any loss, cost, damage, reasonable attorneys' fees or expense incurred by the University by virtue of the contest of such Encumbrance.

- (b) *By the University.* The University shall not do any act or thing that will create any Encumbrance (other than a Permitted University Encumbrance) against the Utility System and shall promptly remove any Encumbrance (other than a Permitted University Encumbrance) against the Utility System that came into existence as a result of an act of or omission by the University or a Person claiming through the University. The University shall not be deemed to be in default hereunder if the University continuously, diligently, and in good faith contests any such Encumbrance, or the validity thereof (or causes such contest), by appropriate legal proceedings that shall operate to prevent the foreclosure of any such Encumbrance; provided that the University has given advance notification to UMLLC that it is the intent of the University to contest the validity or collection thereof or cause such contest.
- (c) *Removal.* Each Party, if requested by the other Party and at such other Party's costs and expense, shall use its reasonable efforts to assist such other Party in attempting to remove any Encumbrance that has come into existence as a result of an act of or omission by such other Party (other than a Permitted University Encumbrance or a Permitted UMLLC Encumbrance); *provided* that nothing herein shall obligate the University to waive, modify, or otherwise limit or affect the enforcement by the University of any applicable rule, procedure or policy of the University whether or not with respect to the Utility System.

Section 3.6. Single Purpose Covenants. Subject to Section 3.15(c), UMLLC shall, at all times during the Term: (i) be formed and organized solely for the purpose of (A) owning the UMLLC Interest, (B) owning, leasing, operating, improving, using, possessing, controlling, and otherwise dealing with the Utility System, (C) collecting from the University the Utility Fee in consideration of providing the services hereunder to the University and any fees from third parties

to which it provides services to the extent permitted by Section 3.15(c), (D) financing its interest in the Utility System, and (E) carrying out the Utility Services and other activities permitted pursuant to this University Lease (and any activities reasonably incidental thereto); (ii) not engage in any business unrelated to clause (i) above; (iii) not have any assets other than those related to its activities in accordance with clauses (i) and (ii) above; (iv) except as appropriate for Tax reporting purposes, maintain its own separate books and records and its own accounts; (v) observe all corporate, limited partnership or limited liability company, as applicable, formalities and do all things necessary to preserve its existence; (vi) not guarantee or otherwise obligate itself with respect to the debts of any other Person; (vii) except as expressly permitted hereby or by any Leasehold Mortgage, or in the ordinary course of business of the Utility System, not pledge its assets for the benefit of any other Person; and (viii) maintain adequate capital in light of its contemplated business operations.

Section 3.7. Rights of the University to Access and Perform Work on the Utility System and Utilize Space for Energy Resources and Research Purposes.

- (a) *Reservation of Rights.* The University reserves (for itself and any of its Representatives, grantees, tenants, contractors, mortgagees, licensees, concessionaires, and others claiming by, through, or under the University) and shall, at all times during the Term, have the right to enter the Utility Facilities and have access to the Utility System in response to any of the following events or circumstances or for any of the following purposes, *provided* that (x) with respect to Section 3.7(a)(i) and Section 3.7(a)(ii), such right is to be exercised at all reasonable times upon reasonable prior notice to UMLLC, (y) with respect to Section 3.7(a)(iii), such right is to be exercised at all reasonable times upon reasonable prior notice to UMLLC if practicable under the circumstances, and (z) with respect to Section 3.7(a)(iv), Section 3.7(a)(v), Section 3.7(a)(vi), and Section 3.7(a)(vii) such right is to be exercised at all reasonable times with the University to request, with reasonable prior notice, UMLLC's consent to the exercise of such right, which consent shall not be unreasonably withheld, conditioned or delayed, provided that if UMLLC has not responded to such request within five (5) Business Days, it shall be deemed to have consented to such exercise:
- (i) to inspect the Utility System, including performance of an assessment of the condition of the Utility System or any component thereof, or determine whether or not UMLLC is in compliance with its obligations under this University Lease or applicable Law pursuant to Section 8.3;
 - (ii) if a UMLLC Default then exists, subject to the cure rights of any Leasehold Mortgagee under Section 19.3, to make any necessary repairs to the Utility System and perform any work therein pursuant to Section 16.1(b)(iii) in accordance with Prudent Industry Practices;
 - (iii) in the event of an Emergency or danger that threatens to cause injury to individuals (or damage to property) or to materially impair the continuous operation of the Utility System and if UMLLC is not then taking all necessary steps to rectify or deal with said Emergency or danger, to take

actions as may be reasonably necessary to rectify such Emergency or danger in accordance with Prudent Industry Practices, in which event the University shall promptly give UMLLC written notice of such measures taken by the University;

- (iv) at its own cost and expense, to (A) install, design, manage, maintain, repair, and rehabilitate any existing or future safety measures for the University Campus (whether provided by the University or third parties at the University's instruction) in, on, under, across, over, or through the Utility System (including surveillance equipment and other safety equipment), (B) grant easements and rights on, over, under, or within the Utility System for the benefit of suppliers or owners of any such measures, and (C) use the Utility System in connection with any such installation, design, management, maintenance, repair, or rehabilitation (provided that notwithstanding the foregoing clauses (A), (B), and (C), UMLLC shall have the right, at all times during the Term, to install, design, manage, maintain, repair, and rehabilitate safety measures for its own account (and not for lease, resale, or service to third parties) to the extent that the said safety measures are necessary for the Utility System Operations or as otherwise permitted under this University Lease);
- (v) at its own cost and expense, to (A) install, design, manage, maintain, repair, and rehabilitate any existing or future utilities or similar services (whether provided by the University or third parties at the University's instruction) that are not part of the Utility System and do not provide Utilities in, on, under, across, over, or through the Utility System (including water lines, sewer lines, fiber optic cable, other communications and other equipment), and (B) grant easements and rights on, over, under, or within the Utility System for the benefit of suppliers or owners of any such utilities or services that are not part of the Utility System (provided that notwithstanding the foregoing clauses (A) and (B), UMLLC shall have the right, at all times during the Term, to install, design, manage, maintain, repair and rehabilitate utilities or other services for its own account (and not for lease, resale, or service to third parties) to the extent that the said utilities or services are (x) necessary for the Utility System Operations and (y) not otherwise Excluded Utility System Projects);
- (vi) at its own cost and expense, to (A) design and install any Excluded Utility System Project, and (B) grant easements and rights on, over, under, or within the Utility System for the benefit of contractors with respect to such Excluded Utility System Project; and
- (vii) at its own cost and expense (except as otherwise expressly provided in this University Lease) and solely in accordance with the terms hereof, to do any other act or thing that the University may be obligated to do or have a right to do under this University Lease;

provided, however, that the University shall (A) not be obligated to make any payments to UMLLC for such access (other than Concession Compensation to the extent required by the next proviso) and the University shall use reasonable efforts to minimize interference with the Utility System Operations in connection with any entry on the Utility System pursuant to this Section 3.7(a), (B) not have access to any software or other intangibles of UMLLC, and (C) comply with UMLLC's reasonable safety protocols and requirements to the extent provided in writing in advance to the University; *provided, further*, that any entry into the Utility System pursuant to clauses (v), (vi), or (vii) of this Section 3.7(a) shall be a Compensation Event.

- (b) *Access Rights.* The University and any of its Representatives, grantees, tenants, contractors, mortgagees, licensees, concessionaires, and others claiming by, through, or under the University, during the progress of any work referred to in this Section 3.7 shall have all necessary easement and access rights to the Utility System. To the extent that the University undertakes work or repairs in the Utility System under this Section 3.7 or any other provision of this University Lease, such work or repairs shall be commenced and diligently completed in a good and professional manner, in accordance with any applicable Performance Standards and UMLLC's reasonable safety protocols and procedures to the extent provided in writing in advance to the University and in such a manner as not to unreasonably interfere with UMLLC's conduct of business in or use of such space.
- (c) *Renewable and Other Energy Resources.* UMLLC and the University recognize the value of exploring the use of renewable energy, energy storage, and other energy resources, and, consistent therewith, the University reserves the right to use portions of the Utility System for the installation, operation, replacement, and repair of energy apparatus, equipment, or improvements, including solar panels as well as collection and distribution facilities in accordance with Prudent Industry Practices and applicable Law. The University shall have the right to install or replace such energy apparatus, equipment, or improvement. Prior to any such installation, the University shall provide UMLLC written notice that includes the plans and schedule for completing such installation or replacement or, alternatively, the University may provide UMLLC a written notice requiring it to complete such installation or replacement as part of a University Directive, which notice shall include the plans, specifications, schedule (including the liquidated damages for failure to meet such schedule), and cost therefor. If UMLLC is directed to install or replace such energy apparatus, equipment, or improvement, (i) it shall do so in accordance with the terms and conditions of the University's notice and (ii) to the extent such energy apparatus, equipment, or improvement is a Capital Improvement, it shall, to the extent the costs therefor are incurred by UMLLC, be deemed to be a Capital Improvement Approved in accordance with Section 4.3(c)(i) (including the budgeted costs and liquidated damages set forth in such notice), and, once installed, shall be deemed part of the Utility System. Any such access contemplated by this Section 3.7(c) shall comply with the access right requirements set forth above in Section 3.7(b). In connection therewith, upon the request of the University, UMLLC agrees that it shall cause any such energy apparatus, equipment, or improvement to be connected to, or become part of, the Utility

System in a manner that complies with UMLLC's reasonable interconnection and generation standards and is in accordance with Prudent Industry Practices and applicable Law, and that UMLLC will use any energy resources generated or stored by such apparatus, equipment, or improvement in the operation of the Utility System to the extent such energy is made available for use in the Utility System. To the extent that UMLLC incurs costs for such interconnections (including any costs of installation, operation, replacement and repair), such costs shall be Uncapped O&M Costs.

- (d) *Effect of Reservation.* Any reservation of a right by the University and any of its Representatives, grantees, tenants, contractors, mortgagees, licensees, concessionaires, and others claiming by, through, or under the University to enter the Utility System and to make or perform any repairs, alterations, Restoration, or other work in, to, above, or about the Utility System which is UMLLC's obligation pursuant to this University Lease, shall not be deemed to (i) impose any obligation on the University to do so, (ii) render the University liable to UMLLC or any other Person for the failure to do so, or (iii) relieve UMLLC from any obligation to indemnify the University as otherwise provided in this University Lease. Nothing in this University Lease shall impose any duty upon the part of the University to do any work required to be performed by UMLLC hereunder and performance of any such work by the University and any of its Representatives, grantees, tenants, contractors, mortgagees, licensees, concessionaires, and others claiming by, through or under the University shall not constitute a waiver of UMLLC's default in failing to perform the same. For the avoidance of doubt and notwithstanding any other provision of this University Lease, access to the Utility System by the University and its staff, students and Representatives shall be subject to and in accordance with UMLLC's reasonable access and safety protocols to the extent provided in writing in advance to the University.
- (e) *Energy Research and Education.* UMLLC acknowledges that energy research and education is a significant focus of the University. The University and its energy industry research partners recognize the value of conducting applied energy research in real-world settings, and, consistent therewith, the University reserves the right to use portions of the Utility Facilities for the installation, evaluation, testing, operation, and replacement of energy apparatus, equipment, or improvements to serve research and academic purposes. Any such access contemplated by this Section 3.7(e) shall (i) comply with the access right requirements set forth above in Section 3.7(b), (ii) be in accordance with Prudent Industry Practices and applicable Law, and (iii) comply with UMLLC's reasonable safety protocols and procedures to the extent provided in writing in advance to the University. In connection therewith, upon the request of the University, UMLLC agrees that it shall cooperate and take all reasonable actions to cause any such energy research apparatus, equipment, or improvement to be connected to the Utility Systems, including associated data collection apparatus, equipment, or improvement, in a manner that complies with UMLLC's reasonable interconnection standards, provided that, unless disclosure is required by applicable Law, the University shall maintain any information received by the University in

connection therewith confidential in accordance with Section 8.2(b) if UMLLC has identified such information as a trade secret. UMLLC agrees that any intellectual property, including copyrights, patents, trade secrets, and trademarks, created or generated by or related to any of the University's actions under this Section 3.7(e) shall not be considered owned or created by UMLLC, notwithstanding that the University or its energy industry research partners may access or use the Utility System with respect thereto, and UMLLC shall have no rights with respect thereto unless the University enters into a separate agreement with UMLLC granting such rights. To the extent that UMLLC incurs costs for such connections, such costs shall be Uncapped O&M Costs. UMLLC also acknowledges that as part of the University's research, the University may request information regarding the Utility System, which information shall be provided pursuant to Section 3.12(a).

Section 3.8. Payment of Taxes. UMLLC shall pay when due all Taxes payable during the Term in respect of the use of, operations at, occupancy of, or conduct of business in or from the Utility System, including any Property Taxes in respect of the Utility System, subject to this Section 3.8. The Parties acknowledge that, as of the Turnover Date, the Utility System is exempt from Property Taxes. To the extent the Utility System or any portion thereof becomes not exempt from any Property Taxes due to any cause other than acts or omissions of UMLLC or its Representatives, the actual costs of any resulting Property Taxes payable during the Term shall be an Uncapped O&M Cost; otherwise such costs shall be borne and paid by UMLLC. UMLLC may contest any Taxes for which it is responsible pursuant to this Section 3.8 provided that (i) no such contest may involve a reasonable possibility of forfeiture or sale of the Utility System, and (ii) upon the final determination of any such contest, if UMLLC has not already done so, UMLLC shall pay any amount found to be due, together with any costs, penalties and interest. The University shall, at no out-of-pocket cost to the University, reasonably cooperate with UMLLC in any reasonable attempt by UMLLC to reduce or eliminate UMLLC's Tax liability. Notwithstanding anything contained herein to the contrary, it shall never be deemed an Adverse Action if the Utility System or any portion thereof becomes not exempt from any Property Taxes.

Section 3.9. Utilities.

- (a) *Charges.* Unless otherwise directed by the University in writing, UMLLC shall ensure that contracts for utilities (other than those utilities that constitute Supplies, which is addressed in Section 7.3) provide that invoices for all charges (including all applicable Taxes and fees) for such utilities and services used in the Utility System Operations during the Term are remitted to UMLLC, which UMLLC shall pay. The University does not warrant that any utility services will be free from interruptions caused by war, insurrection, civil commotion, riots, acts of God, government action, terrorism, repairs, renewals, improvements, alterations, strikes, lockouts, picketing, whether legal or illegal, accidents, inability to obtain fuel or supplies, or any other causes, and any such interruption of utility services in and of itself shall never be deemed an Adverse Action or an eviction or disturbance of UMLLC's use of the Utility System or any part thereof, or render the University liable to UMLLC for damages or, unless the same constitutes a Delay Event, relieve UMLLC from performance of UMLLC's obligations under this University Lease.

- (b) *Utility Coordination.* Subject to Section 7.3, UMLLC shall coordinate all Utility System Operations with utilities and Persons having service lines, pipelines, transmission lines and other equipment, cables, systems and other apparatus in, on, under, over, adjacent to or otherwise interconnecting with the Utility System. UMLLC shall notify the University in writing prior to communicating with any such utilities or Persons and shall take the University's direction in connection therewith, provided such direction is in accordance with Prudent Industry Practices and applicable Law. If UMLLC follows the direction of the University pursuant to the immediately preceding sentence, it shall be deemed to have satisfied its obligations with respect to this Section 3.9(b) solely with respect to the matter to which such direction by the University relates. In connection with its obligations under this Section 3.9(b), UMLLC shall cause provision to be made for the removal or temporary or permanent relocation and restoration of utilities and other services and any lines, equipment, cables, systems and other apparatus not used in connection with Utility System Operations that intersect, interfere with, interface with or otherwise affect the Utility System Operations and shall arrange for temporary rights of entry and access to utilities and other services to be made available that are necessary in connection with the Utility System Operations or as may exist under this University Lease or applicable Law; *provided* that the University shall cooperate with UMLLC with respect to UMLLC's obligations under this Section 3.9(b).
- (c) *No Interference.* The Parties understand and agree that nothing in Section 3.9(b) is in any way intended to interfere with the Utility System Operations by UMLLC, and the University shall cooperate with UMLLC in minimizing any effect that the obligations of UMLLC under Section 3.9(b) and this Section 3.9(c) may have on the Utility System Operations, including reasonable efforts to schedule any such works outside of the academic term or on weekends.
- (d) *Communications Systems.* To the extent that UMLLC utilizes or connects with the University's communications systems, UMLLC shall be responsible for the operation and maintenance of its telecommunications systems up until the point of connection with the University's system in accordance with the Performance Standards.

Section 3.10. Notices of Defaults and Claims.

- (a) *Notice by UMLLC.* UMLLC shall promptly give notice to the University (i) if UMLLC becomes aware that a UMLLC Default has occurred under this University Lease (provided, however, that the failure to give such notice shall not constitute an independent UMLLC Default) and (ii) of all material claims, proceedings, disputes (including labor disputes), or litigation in respect of UMLLC pertaining to the Utility System, the Utility System Operations, or the University (whether or not such claim, proceeding or litigation is covered by insurance) of which UMLLC is aware (other than as a result of a notice to UMLLC from the University). UMLLC shall provide the University with all reasonable information requested by it from time to time concerning the status of such claims, proceedings or litigation.

- (b) *Notice by the University.* The University shall promptly give notice to UMLLC (i) if the University becomes aware that a University Default has occurred under this University Lease (provided, however, that the failure to give such notice shall not constitute an independent University Default) and (ii) of all material claims, proceedings, disputes (including labor disputes), or litigation in respect of the University pertaining to the Utility System, the Utility System Operations or UMLLC (whether or not such claim, proceeding or litigation is covered by insurance) of which the University is aware (other than as a result of a notice to the University from UMLLC). The University shall provide UMLLC with all reasonable information requested by it from time to time concerning the status of such claims, proceedings or litigation.

Section 3.11. Assignment of Operating Agreements and Plans; Project Intellectual Property.

- (a) *Operating Agreements and Plans.* At the request of the University, UMLLC shall collaterally assign, to the extent reasonably practicable and subject to the terms and conditions herein, to the University, in form and substance satisfactory to the University, all of the right, title and interest of UMLLC in, to, and under all or any of the Operating Agreements and all present and future specifications, plans, drawings, information, and any other documentation (except Project Intellectual Property) in relation to the Utility System Operations regardless as to whether any of the foregoing involve proprietary information (collectively, the “Operating Agreements and Plans”) as collateral security to the University for the observance and performance by UMLLC of its covenants and obligations under this University Lease. UMLLC covenants that it shall cause all of the right, title, and interest of UMLLC in, to, and under all Operating Agreements and Plans entered into or created after the Time of Turnover to be collaterally assignable and transferable to the University as provided in this Section 3.11(a). the University acknowledges and agrees that the Operating Agreements and Plans may also be assigned as security to a Leasehold Mortgagee and that each of the University and such Leasehold Mortgagee shall be entitled to use the Operating Agreements and Plans in enforcing their respective security interests as hereinafter provided. Without limiting the generality of the foregoing, the University shall be entitled to use the Operating Agreements and Plans in the event of, and as necessary to, remedy a UMLLC Default under this University Lease for so long as such UMLLC Default is continuing and has not been cured. Notwithstanding the foregoing, in the event that any such Leasehold Mortgagee has entered into possession or is diligently enforcing and continues to diligently enforce its security, whether by way of appointment of a receiver or manager, foreclosure or power of sale in accordance with Article 19 or otherwise, or has entered (or is in process to enter) into a New Agreement under Section 19.5 and is using the Operating Agreements and Plans in respect of the Utility System Operations, the University shall not be entitled to use the Operating Agreements and Plans in enforcing its security, it being acknowledged that any assignment of the Operating Agreements and Plans to a Leasehold Mortgagee shall have priority at all times (other than if the University is enforcing its rights to cure under Section 3.3(c)(i)(B) or, if the Leasehold

Mortgagee's extended cure period under Section 19.3, if any, has expired and the Leasehold Mortgagee has not commenced any action to effect a cure in accordance therewith, Section 16.1(b)(iii) over any assignment of the Operating Agreements and Plans to the University. UMLLC shall promptly deliver to the University, at the sole cost and expense of UMLLC, forthwith after completion or execution and delivery, a copy of each item of the Operating Agreements and Plans. The University agrees that (i) it shall bear all risks associated with the use of the Operating Agreements and Plans, (ii) it may not rely on the Operating Agreements and Plans, and (iii) under no circumstances will UMLLC be liable in any way with respect to the University's use of, or for any loss or damage of any kind incurred as a result of the use of, the Operating Agreements and Plans.

- (b) *Project Intellectual Property.* The University shall have and is hereby granted a nonexclusive, transferable, irrevocable, perpetual, fully paid up right and license to use, exploit, reproduce, modify, adapt, and disclose, and sublicense others to use, reproduce, modify, adapt, and disclose, the intellectual property (including business systems and patents) of UMLLC, the Concessionaire, the IMP Contractor, or the Operator solely used in connection with the Utility System (the "Project Intellectual Property"), subject to the following:
- (i) The University shall have the right to exercise such license only in connection with the Utility System and Utility System Operations;
 - (ii) The University shall have the right to exercise such license only at the following times: (A) from and after the expiration or earlier termination of the Term for any reason whatsoever; (B) during any time that the University is exercising its rights pursuant to Section 3.7(a)(ii) or Section 3.7(a)(iii); and (C) during any time that a receiver is appointed for UMLLC, or during any time that there is pending a voluntary or involuntary proceeding in bankruptcy in which UMLLC is the debtor;
 - (iii) The University shall not at any time use, reproduce, modify, adapt and disclose, or allow any party to use, reproduce, modify, adapt and disclose, any such Project Intellectual Property for any other purpose;
 - (iv) the right to transfer the license is limited to any Person that succeeds to the power and authority of the University generally or with respect to the Utility System, and all such transfers shall be subject to Section 3.11(b)(v);
 - (v) the right to sublicense is limited to concessionaires, contractors, subcontractors, employees, attorneys, consultants, and agents that are retained by or on behalf of the University in connection with the Utility System, and all such sublicenses shall be subject to Section 3.11(b)(v); and
 - (vi) except to the extent required by Law, the University (A) shall not disclose any Project Intellectual Property to any Person other than authorized transferees and sublicensees who agree to be bound by any confidentiality

obligations of the University relating thereto; (B) shall enter into a commercially reasonable confidentiality agreement if requested by UMLLC with respect to the licensed Project Intellectual Property; and (C) include, or where applicable require the contract with the transferee or sublicensee to include, a covenant to employ sound business practices no less diligent than those used for its own confidential information, and no less diligent than required by commercially reasonable standards of confidentiality, to protect all Project Intellectual Property of UMLLC and other materials provided under the license or sublicense, as the case may be, against disclosure to third parties not in receipt of a license or sublicense, as applicable, and to use the license or sublicense only for the permitted purposes;

provided that: (A) for the avoidance of doubt, UMLLC shall continue to have a full and complete right to use any and all duplicates or other originals of its Project Intellectual Property in any manner it chooses, and (B) the University agrees that if it uses any Project Intellectual Property (x) it shall bear all risks associated with the use of the Project Intellectual Property, (y) it may not rely on the Project Intellectual Property, and (z) under no circumstances will UMLLC be liable in any way with respect to the University's use of, or for any loss or damage of any kind incurred as a result of the use of, the Project Intellectual Property.

Section 3.12. Use of Information and Records.

- (a) Unless prohibited by applicable Law and to the extent reasonably necessary, the University shall be entitled to access all reasonable records, electronic data, and other information collected and retained by UMLLC with respect to the Utility System and the Utility System Operations, including utility usage data, consumption pattern information, and other utility data, and UMLLC shall maintain such records, data, and other information in a format that is readily accessible to the University in order to facilitate the University's efforts with respect to energy efficiency, sustainability, environmental impact and research. The University shall use commercially reasonable efforts to provide at least two (2) Business Days' written notice prior to accessing such records. At least thirty (30) Days prior to the Turnover Date, UMLLC shall deliver to the University for its Approval a proposed policy for the maintenance and retention of all records related to the operation and maintenance of the Utility System (once Approved, the "Record Retention Policy"). If the University does not Approve the Record Retention Policy, it shall provide UMLLC a reasonably detailed explanation for its disapproval, and UMLLC shall, promptly thereafter, submit a revised Record Retention Policy intended to address the University's comments, and this process shall continue until the University Approves a Record Retention Policy. Following the Approval of the Record Retention Policy, UMLLC shall maintain all records related to the operation and maintenance of the Utility System in accordance with such Record Retention Policy. The University covenants and agrees that it will implement safeguards to protect against the disclosure or misuse of any such UMLLC information that is in its care or custody and will promptly inform UMLLC if there

is any breach or suspected breach of security related to such information, subject to Section 8.2(b).

- (b) Unless prohibited by applicable Law, UMLLC shall be entitled to access all reasonable records, electronic data, and other information collected and retained by the University to the extent reasonably required for, and only for the purpose of, UMLLC's performance of its obligations under this University Lease and the Performance Standards, including the maintenance of any Authorization. The University shall promptly make such records, data, and information available to UMLLC as reasonably requested by UMLLC. Unless disclosure is required by applicable Law, UMLLC shall keep confidential any information obtained from the University or its Representatives, including any information obtained through its performance of the Utility System Operations. UMLLC covenants and agrees that it will implement safeguards to protect against the disclosure or misuse of any such University information that is in its care or custody and will promptly inform the University if there is any breach or suspected breach of security related to such information. If any information obtained from the University or its Representatives is provided by UMLLC, or the University on behalf of UMLLC, to any third party, including any equity member of UMLLC, the Concessionaire, the Operator or any Contractor, then (i) UMLLC shall cause such third party to comply with the provisions of this Section 3.12(b) and (ii) UMLLC shall be liable for the disclosure or use of such information by such third party as if UMLLC had disclosed or used it.

Section 3.13. Standard of Operation and Maintenance of the Utility System; Warranty Period Utility System Projects. At all times during the Term, UMLLC shall be required to maintain and operate the Utility System in accordance with the Performance Standards and Prudent Industry Practices. In the event any maintenance, repair, or replacement is required in respect of any Warranty Period Utility System Project, other than in connection with an Emergency (in which case, only to the extent of such Emergency), UMLLC shall consult with the University prior to undertaking any such maintenance or repair. If such maintenance, repair, or replacement could be covered by the warranty provided by the contractor that completed such Warranty Period Utility System Project, as determined by the University acting in good faith, then the University shall make a warranty claim to the contractor providing such warranty and shall use commercially reasonable efforts to pursue such claim and cause the contractor providing such warranty to perform such maintenance, repair or replacement pursuant to such warranty, provided that if the University is unsuccessful in causing such contractor to do so, then UMLLC shall perform such maintenance, repair, or replacement. The foregoing obligation shall expire for each Warranty Period Utility System Project contemporaneously with the expiration of the applicable warranty period from such contractor, and the University shall provide notice to UMLLC of such expiration. Any Excluded Utility System Projects that remain under warranty following their completion by the University and delivery to UMLLC shall be treated as Warranty Period Utility System Projects until the expiration of the applicable warranty period for such Excluded Utility System Project.

Section 3.14. Payments by the University. UMLLC acknowledges and agrees that if the University is required under applicable Law of general application to withhold a portion of any

payment that the University is obligated to make to UMLLC under this University Lease and to pay such amount to a Governmental Authority, the University will be deemed to have satisfied such payment obligation to UMLLC to the extent of such withholding by the University and payment to the appropriate Governmental Authority. If any such withheld amounts are permitted to be paid to UMLLC, the University shall pay such amounts to UMLLC whenever permitted by Law. Any items and payment amounts that, to the Actual Knowledge of the University ten (10) Business Days prior to the Turnover Date, it is legally required to withhold from UMLLC as of the Turnover Date will be listed in Schedule 14 and agreed to by UMLLC, acting reasonably, prior to Turnover as a condition of Turnover, provided that regardless of whether any payment is listed on Schedule 14, the University shall always have the right to withhold payments pursuant to this Section 3.14 if required by Law and shall not be in breach of this University Lease. Prior to withholding any portion of any payment hereunder, the University shall give reasonable prior notice to UMLLC of the proposed withholding, and UMLLC shall promptly notify the University of any challenge by UMLLC to such proposed withholding. For the avoidance of doubt, any payment obligation of a the University's department, office or center required by this University Lease is a payment obligation of the University for purposes of this University Lease, and the University shall either cause such department, officer or center to pay the payment obligation or shall satisfy the payment obligation itself.

Section 3.15. Naming and Signage Rights, Other Revenue Activities and Commercial Advertisements and Activities.

- (a) Due to the importance of having uniform signage on the University Campus for safety and aesthetic purposes, UMLLC shall have no right to name or modify the name of the Utility System or any portion thereof or, unless required to do so by applicable Law, to install signage of any kind thereon, without the University's Approval, which may be withheld in its discretion.
- (b) The University shall have the right, in its discretion, to install, replace, display, and maintain signage (i) that relates to identification or naming of the Utility System, the Utility Facilities, portions thereof, or surrounding areas or (ii) for informational or educational purposes; *provided* that (A) UMLLC shall have no obligation under the Performance Standards to replace or maintain any signage installed by the University for advertising purposes, and (B) the University shall not install any signage that relates to naming of the Utility System, the Utility Facilities, portions thereof, or surrounding areas for a Person that competes directly with UMLLC, the Concessionaire or the Operator.
- (c) UMLLC shall not, without the University's Approval, provide utility services to customers other than the University or make market-based sales of electricity. To the extent the University Approves any such activities, UMLLC shall be liable to the University for, and reimburse the University for, any Losses incurred by the University as a result thereof, including any increase or additional Property Taxes imposed upon the University or the Utility System, the cost of which may not be included in any component of the Utility Fee, provided that the University's Approval shall not be required to explore and investigate such additional sources of revenue so long as UMLLC does not implement such additional sources of

revenue and UMLLC is liable for any Losses to the University as a result of such exploration and investigation. To the extent possible, UMLLC shall pay any increased or additional Property Taxes resulting from such additional sources of revenue directly to the applicable Governmental Authority.

- (d) Notwithstanding anything to the contrary contained herein, due to the importance of having uniform nutritional choices on the University Campus, the University hereby reserves the right to install and operate vending machines in any portion of the Utility System and to access the Utility System for the purposes thereof, and the University shall be entitled to the revenue generated by such vending machines.
- (e) The University and UMLLC agree that they shall execute on Turnover a trademark license agreement in the form attached hereto as Schedule 20.

Section 3.16. Reversion of Utility System. On the Reversion Date, UMLLC shall surrender and deliver to the University all of its rights, title, and interest in the Utility System (including all improvements to the Utility System, the Utility System Assets and all tangible and intangible personal property of UMLLC (including inventories) that is included in the Utility System and used in connection with the Utility System Operations) subject, however, as to any intellectual property included in the Utility System, to any restrictions or prohibitions to disclosure, transfer, or sharing thereof and any other rights of third parties with respect thereto, all in accordance with the provisions of Section 16.3. With respect to any third party or proprietary software utilized by UMLLC in the operation of the metered Utility System at the time of the Reversion Date, UMLLC and the University will negotiate in good faith appropriate license rights and terms for the University's continued use of the software following reversion.

Section 3.17. Police, Fire, Emergency and Public Safety Access Rights. Notwithstanding any other provision of this University Lease, at all times during the Term and without notice or compensation to UMLLC: (i) any police, fire, and emergency services and any other security or emergency personnel retained by or on behalf of the University shall have access, as required by such services or personnel, to the Utility System; (ii) the University shall have access to the Utility System as necessary for the protection of public safety; and (iii) any Governmental Authority with jurisdiction over the Utility System shall have access to the Utility System as necessary for inspection, emergency management, and homeland security purposes, including the prevention of or response to a public safety emergency (so long as any exercise of such jurisdiction, to the extent effected by the University, shall be strictly in accordance with the terms hereof).

Section 3.18. Negotiations with Third Parties. Prior to entering into any agreement with any third party, including any Governmental Authority, in connection with the Utility System Operations (a "Third Party Agreement") that extends or could extend beyond the Term or pursuant to which the University may incur any liability whatsoever thereunder, UMLLC shall submit such Third Party Agreement for Approval by the University (which Approval may be withheld, conditioned, or delayed in the discretion of the University) prior to the execution and delivery thereof (except with respect to Third Party Agreements the absence of which may cause UMLLC or Utility System Operations to fail to be in compliance with applicable Law or this University

Lease, in which case UMLLC may enter into such Third Party Agreement upon notice to the University provided that UMLLC indemnifies the University for any Losses relating thereto).

Section 3.19. Administration of the Public Way. UMLLC acknowledges and accepts that the University holds and administers the Public Way for the non-discriminatory benefit of all Persons and interests, including UMLLC and the UMLLC Interest. The rights granted to UMLLC under this University Lease do not create a priority in favor of UMLLC over any other user of the Public Way, and such rights are subject to the Performance Standards and all provisions of Law.

Section 3.20. Rights to Adjacent Space. The University hereby reserves, and is not demising or leasing to UMLLC, the right or easement to construct and reconstruct and forever maintain the air rights with respect to the Utility Facilities and other property within the Utility System and the right to construct, use or occupy any of the space not directly occupied by the Utility System, including (i) any and all space located above, below or adjacent to any such property, and (ii) any and all space located above, below or adjacent to any improvements within the Utility System as of the date hereof, provided that such construction, use or occupancy does not materially impair the Utility System Operations. For the avoidance of doubt, to the extent that any Utility Facility is buried below the surface of any part of the University Campus, the University shall have the right to construct any building, structure or other improvement on that part of the University Campus, provided such construction does not damage or alter such buried Utility Facilities. The University's exercise of its rights hereunder shall not be subject to any of the terms and conditions of Section 3.7(a).

Section 3.21. Sole Utility Provider. The University covenants that, during the Term, it will not, and it will not contract or agree with any third party to, provide any Utility or Utility Services on the University Campus, except with respect to the following circumstances or activities: (a) as of the Turnover Date, a third party is providing the relevant Utility or Utility Services to a portion of the University Campus, in which case the University may continue to have that third party or a successor thereto or a replacement thereof provide such Utility or Utility Services during the Term on only that portion of the University Campus; (b) as of the Turnover Date, any district utility systems within the University Campus which are generating or distributing Utilities beyond the lines of demarcation identified in the Performance Standards; (c) the University installs systems, equipment or materials for the distribution of Utilities beyond the lines of demarcation identified in the Performance Standards, which shall be performed by or on behalf of the University; (d) the performance of any Capital Improvements described in Section 4.1(b); or (e) the performance of any work on the Building Mechanical Systems.

Section 3.22. Adjustments to the Location or Configuration of the Utility System. The University shall have the right, upon notice to UMLLC, to cause UMLLC to alter the location or configuration of the Utility System or to designate alternative real property for the Utility System Land to the extent the University deems it necessary or useful in the operation and use of the University Campus, including in connection with the reconstruction of a Utility Facility following a fire or other casualty. Except as provided in Section 13.4 with respect to any modifications in connection with a casualty, to the extent such alteration or designation of alternative real property is a Capital Improvement, it shall be considered a New Approved Capital Improvement for a budgeted cost and an increase in the Capped O&M Amount reasonably approved by UMLLC and the University, but, to the extent such alteration or designation of

alternative real property is not a Capital Improvement, the costs incurred by UMLLC, the Concessionaire or the Operator as a result of the University's exercise of its right under this Section 3.22 shall be considered an Uncapped O&M Cost in accordance with the definition thereof. If the University directs UMLLC to relocate the Utility System to a location to which it does not have a right to access pursuant to this University Lease, the University shall grant occupancy rights to UMLLC sufficient for UMLLC to meet its obligations hereunder. If the University designates alternative real property for the Utility System Land, then, upon such designation, (i) such alternative real property shall be deemed Utility System Land for purposes of this University Lease, (ii) UMLLC shall return the prior Utility System Land and all improvements and Utility Facilities thereon to the University in the condition required under Section 16.3, at no additional cost to the University, other than out-of-pocket costs incurred by UMLLC in connection with such transfer (including the cost of recording the conveyance documentation and the cost of a title policy for the alternative real property for the Utility System Land in the event that UMLLC received a title policy with respect to the original Utility System Land), and (iii) in accordance with the University's designation of alternative real property, UMLLC shall relocate the Utility Facilities then existing on the prior Utility System Land to the alternative real property. UMLLC shall have the right to amend the Memorandum of Sub-Lease to reflect any changes resulting from the University's exercise of its right under this Section 3.22, and the University shall reasonably cooperate in such amendment and shall pay the out-of-pocket costs incurred by UMLLC in connection therewith. In connection with alteration as set forth in this Section 3.22, UMLLC and the University shall adjust the Key Performance Indicators in light of such alteration.

Section 3.23. Sales to Individual Customers on the University Campus. UMLLC shall not be permitted to sell any fuels or Supplies to individual customers on the University Campus. To the extent that UMLLC supplies fuels or Supplies to the University for distribution to individual customers, the University shall control the distribution of such fuels or Supplies. UMLLC shall have no interests or rights to charge or collect any payments from the University or such individual customers for the provision of such fuels or Supplies.

Section 3.24. University Master Plan. UMLLC shall reasonably cooperate with the University in connection with the University's master plan (including in connection with the development of the Master Plan to the extent relevant to the Utility System) and shall attend any University meetings regarding such plan if requested by the University.

Section 3.25. Utility System Tours. UMLLC shall provide tours of the Utility System or any portion thereof to the University and its Representatives upon reasonable request by the University, provided that (i) UMLLC shall have the right to refuse to give any tour if such tour would unreasonably interfere with the operation of the Utility System or any of UMLLC's other obligations hereunder and (ii) all tour participants shall be required to comply with UMLLC's reasonable safety protocols and requirements to the extent provided in writing to the University.

Section 3.26. Uniforms. To aid the University's provision of security and safety measures to the University Campus, UMLLC, the Concessionaire, and Operator personnel working on the University Campus shall wear a uniform (and other insignia) that is standard across the Utility System and clearly identifies such personnel as UMLLC, Concessionaire, and Operator personnel and not employees of the University.

Section 3.27. Sustainability. UMLLC acknowledges that the University has a long-term commitment to operating the University Campus in a sustainable manner and that the Utility System Operations are an integral part of that commitment. As such, consistent with Prudent Industry Practices and subject to obtaining any required University Approvals for Capital Improvements and Material Changes, UMLLC agrees that, in connection with the Utility System Operations, it will reasonably cooperate with the University to operate the Utility System in a manner consistent with the University's larger goal to promote a sustainable campus and to acknowledge stewardship of the natural environment and resources by the University and its stakeholders. UMLLC will use commercially reasonable efforts to implement any changes to the Utility System Operations requested by the University in the form of a University Directive to increase the sustainability of the Utility System Operations that do not materially and adversely affect UMLLC's ability to meet its obligations hereunder, including the obligation to meet the Performance Standards. In addition, UMLLC will use commercially reasonable efforts throughout the Term to propose Capital Improvements and Material Changes pursuant to Article 4 that are reasonably intended to increase the sustainability of the Utility System Operations and the University Campus, including reduction of emissions, Utility use, and other impacts on the environment. Further, UMLLC shall attend any University meetings regarding sustainability planning on the University Campus if requested by the University. Further, the Parties acknowledge that what constitutes "sustainability" may evolve over the Term and that the Parties intend that, for purposes of this Section 3.27, "sustainable" and "sustainability" shall have the then-current generally accepted utility industry meaning of the term, which, as of the date of this University Lease, includes undertaking measures to (i) reduce energy and water consumption, (ii) become a net-negative energy use, (iii) reduce the impact of operations on the environment, (iv) recycle and reuse resources, (v) purchase goods and services derived in a sustainable manner, and (vi) employ goods and services that protect the environment. For the avoidance of doubt, UMLLC shall not be required to incur costs that would otherwise be Uncapped O&M Costs to comply with this Section 3.27 unless such costs are included in an Approved Five-Year Plan.

Section 3.28. Student Educational Experiences. During the Term and at the request of the University, UMLLC shall discuss, or shall cause the Concessionaire and Operator to discuss, with the University in good faith the development and maintenance of the following programs of UMLLC, the Concessionaire, or the Operator, as the case may be: (i) a program for the employment of students of the University in connection with the Utility System Operations; (ii) an internship program for University students to gain hands-on, practical experience with structured educational and mentorship opportunities either with respect to the Utility System or other utility systems owned, leased, operated, or maintained by UMLLC, the Concessionaire, the Operator, or any of their Affiliates; (iii) a program for employment of apprentices serving industrial and skilled trades of boiler makers in connection with the Utility System Operations; and (iv) structured educational and mentorship opportunities either with respect to the Utility System or other utility systems owned, lease, operated, or maintained by UMLLC, the Concessionaire, the Operator or any of their Affiliates; in each case which shall be on such reasonable terms and conditions as determined by UMLLC, the Concessionaire, or the Operator, as applicable.

Section 3.29. Office Space. To the extent requested by UMLLC in writing, the Parties shall use reasonable efforts to enter into a commercially reasonable license agreement with respect to the temporary license of office space (not to exceed [●] square feet) by the University to

UMLLC within a location on the University Campus at no additional cost. The University shall not be required to provide such space if it determines, in its sole discretion, that it does not wish to provide such space based on its current use, and it may terminate such license or may cause such licensed space to be moved to a new location at any time upon Notice to UMLLC and may require UMLLC to abide by reasonable rules and regulations, including limiting the hours of access thereto.

Section 3.30. Utility System Space in Larger Buildings. UMLLC acknowledges that each of [●] (the “Shared Spaces”) are not separate buildings but are spaces within larger buildings that the University owns. As such, the University shall retain the responsibility, either by the University employees or Contractors at the University’s direction, to maintain, repair, replace, and keep in good order and condition the structural and building-system components of the buildings in which the Shared Spaces are located, including the roof, load-bearing walls, and foundations of each of the foregoing, except to the extent any maintenance, repair or replacement is caused by the negligence or willful misconduct of, or violation of applicable Law by, UMLLC or its Representatives, in which case UMLLC shall be responsible therefor and shall perform such maintenance, repair or replacement as promptly as reasonably practicable. Subject to the University’s rights under Section 3.22, if a building in which a Shared Space is located is damaged by a fire or other casualty of any kind or nature, then the University shall restore such building to the condition in which it existed prior to such fire or other casualty but shall not, for the avoidance of doubt, be responsible for repairing or restoring the furniture, fixtures or equipment within the Shared Space that are part of the Utility System. UMLLC shall abide by any reasonable rules and regulations promulgated by the University and provided to UMLLC in writing with respect to the buildings in which the Shared Spaces are located, and UMLLC shall have non-exclusive access to any common areas of the larger buildings (as identified by the University) in which those Shared Spaces are a part. UMLLC shall not be obligated to pay any additional rent with respect to the Shared Spaces.

ARTICLE 4

CAPITAL IMPROVEMENTS AND MATERIAL CHANGES

Section 4.1. UMLLC Responsibility for Capital Improvements.

- (a) Other than the Excluded Utility System Projects, UMLLC shall be responsible for all Capital Improvements with respect to the Utility System required to be completed by it during the Term in accordance with the terms of this University Lease, including as required by the Performance Standards. For the avoidance of doubt, improvements or upgrades to the Building Mechanical Systems shall not be considered Capital Improvements with respect to the Utility System pursuant to this University Lease.
- (b) Notwithstanding anything in this University Lease to the contrary, the University reserve the right to procure Capital Improvements to the Utility System from any Person other than UMLLC pursuant to a competitive bid or other public procurement if and to the extent that such Capital Improvements are approved by the State through the University’s capital outlay plan, and such State approval of such Capital Improvements and the funds budgeted therefor are contingent on a

competitive bid or other public procurement process therefor; *provided* that, in such a circumstance, to the extent allowed by Law and subject to any conditions imposed by the State on the use of the relevant capital outlay funds, (i) UMLLC shall be allowed to participate in the procurement and delivery process (including drafting performance specifications and oversight of project delivery) for such Capital Improvements to ensure that Key Performance Indicators and Performance Standards are not impacted by the project's design and delivery, and (ii) to the extent reasonably practicable, as part of such competitive bid or other public procurement process, the Parties shall endeavor to procure Utility-related equipment of such brands, models or types that will ensure system compatibility and maximize future repair and maintenance efficiencies (provided that there shall be no exclusivity with respect to the procurement of Utility-related equipment). In the event that (i) the University procures a Capital Improvement from any Person other than UMLLC pursuant to a competitive bid or other public procurement process, as provided in this Section 4.1(b), (ii) such Capital Improvement is funded by moneys sourced from a capital outlay from the State in an amount equal to or greater than fifty percent (50%) of the total capital cost of such Capital Improvement, (iii) the total capital cost of such Capital Improvement exceeds one million dollars (\$1,000,000) in the aggregate, and (iv) the University designates UMLLC (or its Affiliate) the representative of the University with respect to such Capital Improvement on terms acceptable to UMLLC (acting reasonably), then the University shall pay UMLLC a development fee equal to two and one-half percent (2.5%) of the total capital costs of such Capital Improvement that were funded by such capital outlay from the State upon the substantial completion thereof.

Section 4.2. Authorizations Related to Capital Improvements. UMLLC's obligation to perform Capital Improvements shall be subject to the issuance by Governmental Authorities and the University of any and all Authorizations required to be issued by such parties with respect thereto, and the University agrees (i) not to unreasonably withhold, condition or delay the issuance of any Authorization to be issued by the University for an Approved Capital Improvement and (ii) to use its reasonable efforts to assist UMLLC in obtaining any Authorizations required to be issued by Governmental Authorities, provided that UMLLC shall reimburse the University in a timely manner for any reasonable out-of-pocket costs incurred by the University in providing such assistance. Without limiting the generality of the foregoing, the University agrees that it will reasonably assist and cooperate with UMLLC in obtaining any and all Authorizations (including any required rights of access over real property that is owned or controlled by the University) in order for UMLLC to perform an Approved Capital Improvement, which assistance shall include providing UMLLC reasonable access to the areas of the University Campus where the Approved Capital Improvement will be located, subject to the reasonable conditions and restrictions of the University, provided that UMLLC shall reimburse the University in a timely manner for any reasonable out-of-pocket costs incurred by the University in providing such assistance.

Section 4.3. Approval of Capital Improvements and Material Changes.

- (a) UMLLC shall not have the right to make any (i) Capital Improvements or (ii) Material Changes, except those Capital Improvements or Material Changes which either (A) constitute the Initial Modernization Project or (B) are otherwise

Approved pursuant to Section 4.3(c). For the avoidance of doubt, the Approval of Final Design and the performance and delivery of the Initial Modernization Project shall be governed by the specific provisions of this University Lease relating to the Initial Modernization Project (including Section 2.4(f), Article 21, and Article 22). In addition, subject to the provisions of this Section 4.3(a), TEP shall be: (x) the Contractor responsible for the design, construction, and completion of any Capital Improvements or Material Changes which are Approved pursuant to Section 4.3(c); and, in such capacity, (y) under the direction, supervision and control (by ownership, contract or otherwise) of UMLLC or the Concessionaire, and no delegation by UMLLC or the Concessionaire to TEP with respect to such Capital Improvement or Material Change shall relieve UMLLC of any obligations, duties or liability hereunder; [provided that UMLLC shall have the right to appoint a Contractor other than TEP for the purposes of designing, constructing, and completing any Capital Improvements or Material Changes which are Approved pursuant to Section 4.3(c), as jointly determined by the University, UMLLC, and CenTrio, taking into consideration, among other relevant factors, TEP's prior performance and TEP's proposed costs or other terms.]¹

- (b) UMLLC shall have the right to request Approval of (I) a proposed Capital Improvement or Material Change or (II) a change in the scope or cost of a previously Approved Capital Improvement or Material Change at any time (and shall identify whether an item requested for Approval or any portion thereof is a Capital Improvement or Material Change or a combination thereof), but the University shall not be obligated to consider any such requests for Approval except those requests (i) (A) contained in a proposed Five-Year Plan submitted in accordance with Section 7.2 and (B) proposed to be commenced in the first (1st) full Fiscal Year in such proposed Five-Year Plan; (ii) required to address an Emergency, a change in Law or a change in a Performance Standard; (iii) required in connection with a University; or (iv) required due to Force Majeure, all of which the University shall consider in good faith.
- (c) UMLLC shall request Approval of one or more proposed Capital Improvements or Material Changes or Approval of a proposed change in the scope or cost of a previously Approved Capital Improvement or Material Change by (1) submitting a request to the University, or an office or person designated by the University Liaison, containing a detailed description of each proposed Capital Improvement or Material Change or proposed change in the scope or cost of a previously Approved Capital Improvement or Material Change or (2) submitting a proposed Five-Year Plan in accordance with Section 7.2 containing a detailed description of each proposed Capital Improvement or Material Change proposed to be commenced in the first (1st) full Fiscal Year in such proposed Five-Year Plan or each proposed change in the scope or cost of a previously Approved Capital Improvement or Material Change, provided that, in each case, such detailed description shall include: (A) total costs for construction and installation thereof, including all hard and soft costs, any financing costs and any applicable sales or

¹ Note to Draft: LSU will conform the bracketed language to the CEA once finalized.

use tax, which shall be presented on an Open Book Basis; (B) forecasted annual operations and maintenance costs therefor; (C) any proposed modification to the Recovery Period (if applicable) for such Capital Improvement; (D) an explanation of all relevant assumptions, variables, and data sources, used to develop the proposal; (E) the proposed schedules, process, and other technical and logistics details associated with the proposed Capital Improvement and/or Material Change proposal, including any liquidated damages if UMLLC fails to meet the proposed schedule; (F) how such proposed Capital Improvement and/or Material Change will improve the sustainability of the Utility System Operations or the University Campus; (G) any actual or anticipated tax credits or other benefits that will accrue to UMLLC as a result thereof of which UMLLC has knowledge, and a description thereof as well as a description as to how such credits or benefits will be incorporated into the Capital Improvement Cost (if Approved); (H) any fee or charge payable to the Contractor in connection with such Capital Improvement or Material Change; (I) any proposed change to the limits on the professional liability insurance coverage for the professionals providing services with respect to such Capital Improvement or Material Change and the associated change in the premium associated therewith; (J) any potential increase or reduction in Supply Costs or consumption of Supplies that would result from such Capital Improvement or Material Change; and (K) the terms of any payment and/or performance security required by Law or otherwise required hereunder in order to undertake such Capital Improvement or Material Change; *provided* that, (x) to the extent any of the details set out in clauses (A) through (K) above are unavailable or inapplicable, UMLLC shall describe the reason for such unavailability or inapplicability and (y) to the extent that UMLLC has explicitly requested that the University respond only pursuant to Sections 4.3(c)(ii), (iii), or (iv), UMLLC may include an indicative estimate or estimate range with respect to Sections 4.3(c)(A) or (B). To the extent the University elects to, or is required to, consider a request for Approval of a proposed Capital Improvement or Material Change or a change in the scope or cost of a previously Approved Capital Improvement or Material Change, the University shall review such request and, in its discretion:

- (i) Approve such request in accordance with the terms of such request after having undertaken all such necessary action and secured all authorizations, consents and approvals required to be obtained by the University with respect to such Approval at such time, unless UMLLC's written request submitted to the University explicitly requested that the University respond only pursuant to Sections 4.3(c)(ii), (iii), or (iv); or
- (ii) provide a written response requiring that UMLLC (1) perform additional work with respect to such proposed Capital Improvement or Material Change or proposed change in the scope or cost of a previously Approved Capital Improvement or Material Change to provide further information regarding the scope, design or cost thereof and/or multiple alternative designs therefor to the University, which additional work may include procuring design services or a quotation for a guaranteed maximum price or lump sum contract from a contractor or multiple contractors for the

proposed Capital Improvement or Material Change or proposed change in the scope or cost of a previously Approved Capital Improvement or Material Change or procuring any details set out in clauses (A) through (K) of Section 4.3(c)(2) that were previously unavailable, provided that the cost of such additional work shall be subject to the University's prior Approval, and (2) after performing such additional work, submit a revised request for Approval by the University pursuant to this Section 4.3(c), which revised request, if the initial request was made in connection with the submission of a proposed Five-Year Plan, the University shall consider with respect to the same proposed Five-Year Plan, if submitted within fifteen (15) Days before the commencement of the first (1st) Fiscal Year of such Five-Year Plan; or

- (iii) (1) provide UMLLC with comments on such proposed Capital Improvement or Material Change or proposed change in the scope or cost of a previously Approved Capital Improvement or Material Change, including comments on any details provided in UMLLC's proposal, which may include comments from the University intended to align the proposal with the larger University Campus capital improvement plans existing at such time or disagreeing with its characterization as a Capital Improvement or Material Change, and (2) require that UMLLC incorporate such comments and submit a revised request for Approval pursuant to this Section 4.3(c); *provided* that if the University elects to exercise its rights under this Section 4.3(c)(iii), then UMLLC shall have the right, upon written notice to the University, to withdraw its request for Approval; or
- (iv) (1) reject such proposed Capital Improvement or Material Change or proposed change in the scope or cost of a previously Approved Capital Improvement or Material Change and (2) if such proposed Capital Improvement or Material Change or change to the scope of a previously Approved Capital Improvement or Material Change is necessary to comply with Prudent Industry Practices, applicable Law, or the Performance Standards, provide UMLLC with a reasonably detailed explanation for such rejection, provided that the University shall not be permitted to reject such proposal under this Section 4.3(c)(iv) if (w) such proposal is required to cause the Utility System to comply with any new Law or change in Law existing as of the Turnover Date and UMLLC has received written notice from the applicable Governmental Authority that the Utility System is not in compliance therewith, (x) UMLLC has reasonably investigated any potential alternatives to such proposal and provided the University with reasonable evidence of such investigation, (y) UMLLC has discussed in good faith with the University and reasonably considered any potential viable alternatives to such proposal and (z) the University has provided no reasonable alternative that would address such new or changed Law, as applicable, that the University has confirmed that it would Approve.

Notwithstanding anything to the contrary in the foregoing, if a single request for Approval pursuant to this Section 4.3(c) includes multiple discrete proposed Capital Improvements or Material Changes or changes in the scope or cost of a previously Approved Capital Improvement or Material Change, the University shall have the right to provide different responses with respect to each proposal included in such request.

- (d) To the extent that UMLLC elects to abandon a proposed Capital Improvement or Material Change after it has been Approved by the University, which UMLLC may do so upon Notice to the University, unless such Capital Improvement or Material Change is the subject of a University, UMLLC shall be obligated to promptly restore the Utility System and any other affected area of the University Campus to the condition that existed prior to the commencement of such Capital Improvement or Material Change. As a condition of its Approval of any proposed Capital Improvement or Material Change or proposed change in the scope or cost of a previously Approved Capital Improvement or Material Change, the University may require certain payments of liquidated damages by UMLLC to the University if UMLLC does not meet the timeframe set forth in the applicable Approval regardless of the abandonment of such Capital Improvement or Material Change, but only to the extent such liquidated damages are proposed in UMLLC's most recent request for Approval thereof. To the extent that the University elects to suspend or cancel a Capital Improvement or Material Change after such Capital Improvement or Material Change has been approved by the University, then (i) in the case of a suspension, any such suspension shall be treated as a University in accordance with Article 5 and (ii) in the case of a cancellation, (A) any Capital Improvement Costs incurred by UMLLC prior to the date of cancellation (including all reasonable and documented demobilization and contractor breakage costs) nonetheless shall be included in the Unrecovered Balance and (B) any costs incurred with respect to such Material Change prior to the date of cancellation (including all reasonable and documented demobilization and contractor breakage costs) nonetheless shall be included in the Uncapped O&M Costs.
- (e) To the extent a proposed Capital Improvement or proposed change in a previously Approved scope or cost of a Capital Improvement is Approved, UMLLC shall have the right to (i) deem the cost of such Capital Improvement (up to the Approved amount) or the change in such cost (up to the Approved amount), as applicable, a New Approved Capital Improvement Cost in accordance with Schedule 5 and (ii) include the out-of-pocket costs incurred by UMLLC in connection with preparing and submitting a revised request for Approval of such Capital Improvement pursuant to Section 4.3(c)(ii) (if applicable) as part of such New Approved Capital Improvement Cost. The Approved out-of-pocket costs incurred by UMLLC pursuant to Section 4.3(c)(ii)(1) in connection with a proposed Capital Improvement or a proposed change in the scope or cost of a previously Approved Capital Improvement that is not Approved shall be included in Uncapped O&M Costs. For any proposed Material Change that is not a Capital Improvement or any proposed change in the scope or cost of a previously Approved Material Change,

the out-of-pocket costs incurred by UMLLC pursuant to Section 4.3(c)(ii) shall be included in Uncapped O&M Costs.

- (f) After Approval of a proposed Capital Improvement or Material Change or a proposed change in the scope or cost of a previously Approved Capital Improvement or Material Change, UMLLC shall make such Capital Improvement or Material Change in accordance with this University Lease, but subject to Section 4.3(d).
- (g) Notwithstanding anything to the contrary contained in this Section 4.3, to the extent that UMLLC incurs any out-of-pocket costs that qualify as operation or maintenance costs (as reasonably determined in accordance with GAAP) in the exercise of its rights and performance of its obligation pursuant to this Section 4.3, UMLLC shall have the right to request that the University Approve those costs as a Capital Improvement, and such request shall be a considered a request for Approval of a proposed Capital Improvement; *provided* that, for the avoidance of doubt and without limitation, the University may Approve such costs as a Capital Improvement on the condition that the Capped O&M Amount is equitably reduced to account for UMLLC's recovery of such costs by means of the Variable Fee Component instead of the Capped O&M Amount.
- (h) The cost of (i) any Approved Material Changes and (ii) any Approved Capital Improvements that are less than one hundred thousand dollars (\$100,000) (Adjusted for Inflation) will be classified as Uncapped O&M Costs for purposes of calculating the Utility Fee, unless otherwise indicated by the University, in its discretion, in its Approval thereof.

Section 4.4. University's Capital Plan. UMLLC shall reasonably cooperate with the University in the development, modification, and discussion of the University's capital plans and energy conservation initiatives, including participating with the University's capital planning and capital plan forecasting processes, attending planning meetings, and, as requested by the University, attending and participating in meetings related to the University's capital plans.

Section 4.5. Distribution System; Distribution System Capital Improvements.

- (a) *Status of Distribution System as of Turnover Date.* As of the Turnover Date, (i) except as set forth in the definition of Distribution Bottlenecks, the Distribution System is not included in the Utility System or Utility Facilities and (ii) the Utility Services do not include any services in respect of the Distribution System.
- (b) *Initiation of Consideration of Distribution System Capital Improvements.* Either Party may initiate the process by which the University and UMLLC will engage with respect to a Distribution System Capital Improvement, as set forth below.
 - (i) *By UMLLC.* At any time during the Term, UMLLC may, by written notice to the University, request the University to consider whether to invite a proposal from UMLLC for Approval of a Distribution System Capital Improvement. Within thirty (30) days of the receipt of such request by

UMLLC, the University shall determine whether to invite a proposal from UMLLC pursuant to Section 4.5(c), which determination shall be made in the University's discretion.

- (ii) *By the University.* At any time during the Term, the University may, by written notice to UMLLC, initiate a request for UMLLC to prepare a proposal for a Distribution System Capital Improvement pursuant to Section 4.5(c).
- (c) *Proposal for Distribution System Capital Improvement.* Upon the initiation of the request to UMLLC to prepare a proposal as set forth in Section 4.5(b), UMLLC shall, within sixty (60) days of such request from the University, deliver a proposal to the University requesting Approval of such Distribution System Capital Improvement. The scope of such request for Approval shall be consistent with the requirements for requests for Approval of Capital Improvements as set forth in Section 4.3 as if such proposal was in respect of a Capital Improvement.
- (d) *Negotiation Period.* Following the University's receipt of the proposal for Approval of the Distribution System Capital Improvement pursuant to Section 4.5(c), the Parties shall negotiate in good faith concerning the University's consideration for Approval of such Distribution System Capital Improvement for a period of not less than ninety (90) Days. If the Parties, after such good faith negotiations, do not reach an agreement concerning such Distribution System Capital Improvement, the University shall have the right to pursue such Distribution System Capital Improvement through other means, subject to the rights of UMLLC set forth in Section 4.5(e).
- (e) *UMLLC Right of First Refusal.* If, following the expiration of the good faith negotiation period set forth in Section 4.5(d), the University elects to pursue the financing, funding or construction of such Distribution System Capital Improvement through other means, the University shall have, prior to entering into any agreement to construct or permit the construction of such Distribution System Capital Improvement, an ongoing obligation (i) to give UMLLC notice of the intention to enter into a separate agreement for the construction of such Distribution System Capital Improvement and (ii) to provide UMLLC the option to enter into an agreement under substantially the same economic terms (or terms otherwise acceptable to the University, in its discretion) within forty-five (45) Days of such notice.
- (f) *Approval of Distribution System Capital Improvement.* To the extent any Distribution System Capital Improvement is Approved by the University, the cost of such Distribution System Capital Improvement shall be included as a New Approved Capital Improvement Cost in accordance with the terms of Schedule 5. To the extent that any Distribution System Capital Improvement is the subject of an agreement of the University and UMLLC pursuant to Section 4.5(e), the University shall pay such compensation to UMLLC as set forth in such separate agreement.

- (g) *Addition of Distribution System to Utility System.* Each relevant component of the Distribution System that is constructed or improved as the result of a Distribution System Capital Improvement upon substantial completion of each such Distribution System Capital Improvement shall be (i) deemed to be part of the Utility System and Utility Facilities for purposes of this Agreement and (ii) included in the Utility System to be operated and the Utility Services to be performed by the Concessionaire under the terms of this Agreement. In addition, with respect to any Distribution System Capital Improvement, UMLLC and the University shall determine in good faith the forecasted annual ongoing operations and maintenance costs associated with such Distribution System Capital Improvement and the associated component of the Distribution System that would be then added to the Utility System (or any reductions in current annual ongoing operations and maintenance costs associated therewith), and the Capped O&M Amount shall be increased (or decreased) by such amount.
- (h) Notwithstanding anything in this Agreement to the contrary, the University reserves the right to procure any Distribution System Improvement funded through the capital outlay process outlined in Section 4.1(b) above or in response to an Emergency, in each case without regard to this Section 4.5.
- (i) For the avoidance of doubt, the University shall not be required to comply with this Section 4.5(e) to the extent such compliance by the University would violate applicable Law (in the reasonable opinion of the University, subject to dispute resolution under Article 18).

ARTICLE 5 MODIFICATIONS

Section 5.1. University Directives. The University may, at any time during the Term, issue a University Directive to UMLLC, which may include (i) the construction of Capital Improvements and the addition to or removal from the Utility System of buildings or other improvements owned, leased, or operated by the University or its Affiliates or (ii) the design, demolition, project management, construction, repair, replacement, remodeling, renovation, reconstruction, enlargement, addition, alteration, painting, or structural or other improvements not included in the Utility Facilities but related thereto. No University Directive shall have the effect of reducing the components of the Variable Fee Component. Subject to UMLLC having obtained (with the cooperation of the University) all relevant Authorizations from all relevant Governmental Authorities required for the relevant work, UMLLC shall perform the work required to implement such University Directive. Utility Facilities constructed as the result of a University Directive shall be (a) deemed to be part of the Utility System for purposes of this University Lease and (b) included in the Utility System to be operated by UMLLC under the terms of this University Lease. To the extent any University Directive requires the construction of a Capital Improvement, the cost of such Capital Improvement shall be included as a New Approved Capital Improvement Cost up to the Approved cost of such Capital Improvement set forth in University Directive. To the extent any University Directive requires the construction of anything other than a Capital Improvement, the costs associated therewith shall be Uncapped O&M Costs in accordance with the definition thereof. In addition, with respect to any University Directive, UMLLC and the

University shall determine in good faith the forecasted annual ongoing operations and maintenance costs associated with such University Directive (or any reductions in current annual ongoing operations and maintenance costs associated therewith), and the Capped O&M Amount shall be increased or decreased by such amount. To the extent that that an order or directive would be a University Directive but for the operation of sub-paragraph (4)(y) of the definition of “University Directive”, and in the event that UMLLC notifies the University in writing that it is not willing to carry out such order or directive for such reason: (A) the University may elect to engage a third party to perform the relevant order or directive, and (B) if the University so elects, the University and UMLLC shall determine in good faith any corresponding adjustments to the Utility Fee and other provisions of the Concession Agreement that may be required to put the Parties in substantially the same economic position as they were prior to such actions being taken, provided the University shall not be required to compensate UMLLC for any benefit that UMLLC would have received if it undertook University Directive. Notwithstanding the foregoing, the University may not issue a University Directive requiring the construction of a Capital Improvement to the extent that such Capital Improvement was previously the subject of a proposal for Approval submitted by UMLLC pursuant to Section 4.3 for a period of twenty-one (21) months following the initial submission of the proposal for Approval of such Capital Improvement; *provided* that this sentence shall apply only to the first such proposal by UMLLC and no other proposal with respect to the same or substantially the same Capital Improvement shall restrict the University from issuing a University Directive hereunder; *provided, however*, nothing in this sentence shall restrict the University from issuing a University Directive in response to an Emergency.

Section 5.2. Performance of Modifications. Subject to the other provisions of this Article 5, UMLLC shall ensure that University Directives are performed in a good and professional manner and diligently complied with and implemented in accordance with Prudent Industry Practices.

Section 5.3. Addition, Removal and Lease of Property.

- (a) If, after the Turnover Date, the University sells, conveys, leases for a period of time longer than the remaining Term, or otherwise transfers ownership of any real property within the University Campus to a third party unaffiliated with the University, then, contemporaneously with such transfer, UMLLC shall disconnect such real property from the Utility System and remove or abandon in place all Utility Facilities and Utility System Assets thereon and shall not be permitted to serve such real property, except if Approved in accordance with Section 3.15(c). However, if the University elects to enter into a concession agreement, ground lease, management agreement, or similar agreement with a third party to operate and maintain any real property that had been part of the University Campus, UMLLC shall not be required to disconnect such real property from the Utility System. If such disconnection causes a Capital Improvement that is or had been a New Approved Capital Improvement to be removed from the Utility System, the Capital Improvement shall continue to be included in the Variable Fee Component in accordance with this University Lease as if not removed from the Utility System. UMLLC shall reasonably cooperate with the University and the transferee of such real property in such disconnection. In connection therewith, the University and UMLLC shall cooperate in good faith to make any reasonably necessary

adjustments to the Key Performance Indicators and the Performance Standards as a result of such sale, conveyance, or lease.

- (b) Due to the fact that UMLLC is agreeing to service the University Campus throughout the Term, if, after the Turnover Date, the University currently or thereafter leases, sub-leases, or otherwise provides a leasehold interest in real property served by the Utility System for less than or equal to the period of time remaining in the Term to a third party unaffiliated with the University, then, to the extent that it would not be prohibited by Law, UMLLC shall continue to provide Utilities to such real property in accordance with this University Lease, and the University shall remain obligated to pay the Utility Fee attributable to such real property. UMLLC is only entitled to the continued receipt of the Utility Fee attributable to such real property and shall have no interests or rights to charge or collect additional payments from the University, the lessees or sub-lessees for the provision of Utilities to such real property.
- (c) The University, at its discretion, may, pursuant to a University Directive, cause UMLLC to provide Utility Services to any portion of the University Campus not served by the Utility System at that time and may expand the definition of the University Campus.

ARTICLE 6 PERFORMANCE STANDARDS

Section 6.1. Compliance with Performance Standards. UMLLC shall, at all times during the Term, cause the Utility System Operations to comply with and implement the Performance Standards in all material respects (including any changes or modifications to the Performance Standards pursuant to the terms of this University Lease); *provided* that UMLLC shall have a reasonable period of time to comply with the introduction of changes or modifications to the Performance Standards that are made from time to time in accordance with the terms of this University Lease. From and after the date on which UMLLC is required to have an Operations Plan pursuant to the Performance Standards, UMLLC shall have in place at all times during the Term an Operations Plan. Except as specifically set forth herein, UMLLC shall perform all work required to comply with and implement the Performance Standards (including the Capital Improvements described therein) as part of the Utility System Operations and at its sole cost and expense.

Section 6.2. Proposed Performance Standards. If UMLLC, at its cost and expense, wishes to implement and use performance standards for the operation of the Utility System other than the Performance Standards, UMLLC must provide notice of such proposed performance standards to the University for Approval. UMLLC's proposed performance standards must be accompanied by an explanation of UMLLC's rationale for making its proposal and all relevant supporting information, certificates, reports, studies, investigations and other materials as are necessary to demonstrate that UMLLC's proposed performance standards are reasonably designed to achieve or improve upon the intent of the applicable Performance Standards and are in compliance with Prudent Industry Practices and applicable Laws. The University may request any additional supporting information, certificates, reports, studies, investigations, and other materials

as are reasonably required by the University to determine if UMLLC's proposed performance standards are reasonably designed to achieve or improve upon the objectives of the applicable Performance Standards. Until the University provides its Approval for the implementation of UMLLC's proposed performance standards, UMLLC shall not implement the proposed performance standards and shall implement and comply with the Performance Standards. UMLLC's proposed performance standards shall be deemed incorporated into the Performance Standards upon Approval by the University in accordance with the terms hereof. It shall be unreasonable for the University to withhold its Approval if the proposed performance standards are reasonably designed to achieve or improve upon the intent of the applicable Performance Standards in a manner that does not unreasonably increase the cost to the University. If the University refuses to Approve any proposed performance standards and UMLLC disagrees with such refusal, UMLLC's sole remedy shall be to submit such dispute to the procedures set forth in Article 18.

Section 6.3. Modified Performance Standards.

- (a) The Parties acknowledge that the services provided hereunder by UMLLC to the University may impact the quality of life on the University Campus. Because of the importance of maintaining high standards with respect to such campus life, the University shall have the right, at any time during the Term, to modify or change the Performance Standards upon notice to UMLLC to (i) comply with any new Law or change in Law applicable to the Utility System Operations, (ii) conform the Performance Standards to standards or practices generally adopted with respect to Comparable Utility Systems or Prudent Industry Practices, or (iii) conform the Performance Standards to a change in the University's design standards after the date hereof of which UMLLC did not have, or could not reasonably be expected to have, notice prior to such change taking effect; any such modification shall not constitute a Compensation Event. In the event the University modifies the Performance Standards in accordance with the immediately preceding sentence, UMLLC shall promptly perform all work required to implement and shall comply with all such modifications and changes and in no event shall UMLLC be excused from compliance with any such modification or change, except as otherwise expressly provided in this University Lease. The cost of such modification or change shall be included in Uncapped O&M Costs (but only to the extent of the costs incurred to cause the Utility System to initially comply with such modification or change) or New Approved Capital Improvement Costs (if such modifications or changes are Capital Improvements). If (x) any such modification or change is a New Approved Capital Improvement and UMLLC and the University determine in good faith the amount of the forecasted annual operations and maintenance costs for such New Approved Capital Improvement or (y) such modification or change is not a New Approved Capital Improvement and UMLLC and the University determine in good faith the amount of the forecasted annual operations and maintenance costs for such modification or change, then, in either case, the Capped O&M Amount shall increase by such amount. UMLLC shall have the right to challenge, pursuant to Article 18, any modified Performance Standard on the grounds that it does not meet the requirement of this Section 6.3(a). In connection with a change in the Performance Standards under this Section 6.3(a), the

University and UMLLC shall cooperate in good faith to make any reasonably necessary adjustments to the Key Performance Indicators and any other Performance Standards as a result thereof.

- (b) If, during the Term, the University is of the opinion that a modification or change to the Performance Standards is necessary or desirable but such modification or change is not required by Section 6.3(a), the University may upon reasonable written notice to UMLLC modify or change the Performance Standards; *provided, however*, that any such change(s) or modification(s) in the aggregate in a Fiscal Year shall constitute a Compensation Event only if such change(s) or modification(s) (i) are not in response to any action or omission on the part of UMLLC, the Concessionaire or the Operator and (ii) result in an increase, during any Fiscal Year, in operating expenses attributable to compliance with such change(s) or modification(s) (taking into account all such previous changes or modifications applicable in such Fiscal Year or any previous Fiscal Year) in excess of seventy-five thousand dollars (\$75,000) (annually Adjusted for Inflation) which cannot be charged through to the University as an Uncapped O&M Cost or recovered as a New Approved Capital Improvement Cost. At the University's request, UMLLC shall perform all work required to implement and shall comply with all such modifications and changes, and in no event shall UMLLC be excused from compliance with any such modification or change.
- (c) The University shall have the right to undertake the work necessary to ensure implementation of and compliance with any such modification or change to the Performance Standards if UMLLC fails to do so within a reasonable period of time; *provided, however*, that to the extent that such work is undertaken by the University, UMLLC shall pay to the University within ten (10) Business Days following demand therefor, or the University may offset from amounts owing to UMLLC in connection with such modification or change, (i) with respect to changes pursuant to Section 6.3(a), all costs to comply with such Performance Standard and (ii) with respect to Section 6.3(b), the costs of the portion of the work performed in order to comply with the Performance Standards existing immediately prior to such modification or change, and the University shall be responsible only for the incremental costs of the additional work required in order to implement such proposed modification or change to the Performance Standards and, without duplication with the foregoing, the Concession Compensation with respect to such modification or change.

ARTICLE 7

UTILITY FEE, FIVE-YEAR PLAN, AND ENERGY SUPPLY

Section 7.1. Utility Fee.

- (a) As compensation for the services provided hereunder by UMLLC to the University in connection with the Utility System, the University shall pay to UMLLC the Utility Fee for each Fiscal Year or portion thereof during the Term, as determined in accordance with the formula described in Schedule 5 and in the manner set forth

in this Section 7.1. At least one hundred eighty (180) Days prior to the commencement of any Fiscal Year during the Term (other than the first (1st) Fiscal Year), UMLLC shall provide a forecast of the Utility Fee (as determined in accordance with Schedule 5, and subject to the limitations therein) to the University for the upcoming Fiscal Year (the “Forecast Utility Fee”), provided that UMLLC shall, by notice to the University (i) on or before ninety (90) Days prior to the commencement of any Fiscal Year and (ii) again at least ten (10) Days and no more than thirty (30) Days prior to the commencement of such Fiscal Year, adjust such Forecast Utility Fee as necessary, as determined by UMLLC in its good faith and reasonable discretion; provided, with respect to the Fiscal Year commencing on the first (1st) July 1 to occur after the Turnover Date, UMLLC shall provide the Forecast Utility Fee to the University by the later of one hundred eighty (180) Days before the commencement of the next Fiscal Year and thirty (30) Days after the Turnover Date. The University shall pay the Forecast Utility Fee in twelve (12) equal monthly installments, payable on the first (1st) Day of every month during the Fiscal Year, provided that if the Term expires on a date that is not the last day of a Fiscal Year, the Forecast Utility Fee for that last partial Fiscal Year shall be prorated based on the number of Days in that last Fiscal Year, provided, further, that the first (1st) payment of the Utility Fee shall be made no sooner than one (1) month after the Turnover Date. The Forecast Utility Fee for the first (1st) Fiscal Year of the Term shall be \$[3,360,851.18] prorated based on the number of Days remaining in the first Fiscal Year after the Turnover and payable in equal monthly installments over the number of months remaining in such Fiscal Year. For purposes of providing the Forecast Utility Fee for any Fiscal Year after the first (1st) Fiscal Year, the Parties shall meet in advance and, acting in good faith, shall agree on the methodology for determining the Forecast Utility Fee, including, but not limited to, estimations of the CPI Index for the current Fiscal Year.

- (b) Within sixty (60) Days after the end of each Fiscal Year, UMLLC shall deliver to the University a statement (the “Reconciliation Statement”) which states the actual Utility Fee (as determined in accordance with Schedule 5, and subject to the limitations therein) for such Fiscal Year and provides a detailed accounting of each component of the Utility Fee in such Fiscal Year, in each case calculated in a form and with such detail as may be reasonably requested by the University for the determination of the Utility Fee set forth in the Reconciliation. If the Reconciliation Statement reveals that the Utility Fee for a Fiscal Year (as determined in accordance with Schedule 5, and subject to the limitations therein) is more than the Forecast Utility Fee for that Fiscal Year, the University agrees to pay UMLLC the difference in a lump sum within thirty (30) Days after receipt of the Reconciliation Statement. If the Reconciliation Statement reveals that the Utility Fee for such Fiscal Year is less than the Forecast Utility Fee for that Fiscal Year, UMLLC will pay the University the difference in a lump sum within thirty (30) Days after receipt of the Reconciliation Statement. In addition to the foregoing, UMLLC shall deliver to the University the quarterly reporting described in Section 8.1(d).
- (c) The records that UMLLC maintains with respect to the calculation of the actual Utility Fee shall be retained by UMLLC for a period of five (5) Fiscal Years

following the Fiscal Year to which such Utility Fee applied. The University shall have the right, through its Representatives, to examine, copy and audit such records at reasonable times, upon not less than five (5) Business Days' prior notice, at such place within the City of Baton Rouge, Louisiana as UMLLC shall reasonably designate from time to time for the keeping of such records. All costs of any such audit shall be borne by the University; *provided, however*, that if such audit establishes that the Utility Fee for the applicable Fiscal Year was lower than the final determination thereof as set forth in the Reconciliation Statement, by at least one percent (1%), then UMLLC shall pay the cost of such audit. If, as a result of such audit, it is determined that the University has overpaid UMLLC on account of the Utility Fee, then UMLLC shall reimburse the University for any (i) undisputed amounts within thirty (30) Days after such determination and (ii) amounts which have been determined to be due pursuant to Article 18 within thirty (30) Days after such determination. If UMLLC disputes the results of an audit conducted pursuant to this Section 7.1(c), UMLLC's sole remedy shall be to submit such dispute to the procedures set forth in Article 18.

- (d) In addition, if an audit conducted pursuant to Section 7.1(c) establishes that the Utility Fee for the applicable Fiscal Year was lower than the final determination thereof, as set forth in the Reconciliation Statement, by at least three percent (3%), then in addition to paying the cost of such audit and reimbursing the University for the payments in accordance with Section 7.1(c), UMLLC shall pay, as liquidated damages, three (3) times the amount of the difference between the Utility Fee and the amount set forth in the Reconciliation Statement. The University and UMLLC agree that it would be impracticable and extremely difficult to fix the actual damage to the University if the actual Utility Fee was lower than the amount shown in the Reconciliation Statement by at least three percent (3%). The University and UMLLC therefore agree that, in such instance, three (3) times the amount of the difference between the Utility Fee and the amount set forth in the Reconciliation Statement is a reasonable estimate of the University's damages and that the University shall be entitled to said sum as liquidated damages. If UMLLC disputes the results of an audit conducted pursuant to Section 7.1(c), UMLLC's sole remedy shall be to submit such dispute to the procedures set forth in Article 18.

Section 7.2. Five-Year Plan.

- (a) UMLLC shall submit to the University a proposed Initial Five-Year Plan on or before ninety (90) Days following the Turnover Date and shall thereafter submit to the University a proposed Five-Year Plan at least one hundred eighty (180) Days prior to the end of each Fiscal Year during the Term. Each proposed Five-Year Plan shall include the Capital Improvements and Material Changes (and shall identify whether an item requested for Approval is a Capital Improvement or Material Change or a combination thereof) that UMLLC proposes to make in each Fiscal Year in such proposed Five-Year Plan as well as anticipated Uncapped O&M Costs, and the anticipated types of Supplies that will be used for each such Fiscal Year, including the estimated usage pattern over the course of the first Fiscal Year. The initial Five-Year Plan can include, and the University will consider in

accordance with Section 4.3, proposed Capital Improvements and Material Changes to the Utility System to address any conditions of the Utility System existing prior to the Turnover Date. Each proposed Five-Year Plan shall be submitted in a format reasonably acceptable to the University as of the date of submission.

- (b) The University shall review and provide comments to UMLLC on the proposed Five-Year Plan, provided that to the extent pertaining to proposed Capital Improvements or Material Changes relating to the first full Fiscal Year in the proposed Five-Year Plan, such review and comments shall be conducted and provided in accordance with Section 4.3(c), and provided further that, subject to Section 7.2(c), if the University shall have previously Approved any such Capital Improvement or Material Change included in the proposed Five-Year Plan, the University shall not have the right to modify or rescind such prior Approval to the extent of such prior Approval. UMLLC shall promptly incorporate and use the University's comments on the proposed Five-Year Plan to prepare a revised version thereof and submit such revised version to the University. This process shall continue until the University Approves all components of the proposed Five-Year Plan, including the estimated usage of Supplies over the first Fiscal Year in such Five-Year Plan.
- (c) The proposed Five-Year Plan Approved by the University shall become the Approved Five-Year Plan as of the commencement of the first (1st) Fiscal Year in such proposed Five-Year Plan (or, in the case of the proposed Initial Five-Year Plan, as of the date of the University's Approval); *provided, however*, that no portion of an Approved Five-Year Plan related to the second (2nd) through fifth (5th) full Fiscal Years therein shall be deemed Approved by the University, except to the extent that a Capital Improvement or Material Change is scheduled pursuant to such Approved Five-Year Plan to be started in the first (1st) full Fiscal Year and completed in the second (2nd) through fifth (5th) full Fiscal Years therein. For the avoidance of doubt, the Approval of a Five-Year Plan that includes a Capital Improvement or Material Change that is not scheduled to be commenced until the second Fiscal Year therein at the earliest shall not be deemed an Approval of such Capital Improvement or Material Change for purposes of Article 4 or this Article 7.
- (d) If UMLLC does not accommodate or otherwise resolve any comment provided by the University pursuant to Section 7.2(b), UMLLC shall deliver to the University, within ten (10) Days after receipt of the University's comments, a written explanation as to why accommodation or other resolution of such comment would not allow UMLLC to meet the requirements of Section 3.2(a)(ii). The explanation shall include the facts, analyses and reasons that support the conclusion regarding such comment. Any dispute between UMLLC and the University over such comment shall be resolved pursuant to the procedures set forth in Article 18.
- (e) If a proposed Five-Year Plan or a portion thereof is not Approved by the commencement of the first (1st) Fiscal Year in such proposed Five-Year Plan, the

Approved Five-Year Plan or relevant portion thereof shall continue in effect until a new proposed Five-Year Plan is Approved, provided that in the case of the proposed Initial Five-Year Plan, no Approved Five-Year Plan shall be in effect until the proposed Initial Five-Year Plan is Approved, and provided further that nothing in this Section 7.2 shall permit UMLLC to make a Capital Improvement or Material Change except if it is Approved in accordance with Section 4.3(c). Until the initial Five-Year Plan is Approved following the Turnover Date, UMLLC shall operate the Utility System in accordance with this University Lease and otherwise in substantially the same manner it had been operated immediately prior to Turnover provided that nothing in this Section 7.2 shall permit UMLLC to make a Capital Improvement or Material Change except if it is Approved in accordance with Section 4.3(c).

- (f) For the avoidance of doubt, UMLLC's right to receive the Utility Fee, subject to the limitations contained herein and in Schedule 5, shall not be modified or superseded by the Approved Five-Year Plan.
- (g) Except as otherwise provided in Section 7.2(c), the contents of any Approved Five-Year Plan shall not be binding on any future Five-Year Plan.
- (h) Notwithstanding anything to the contrary in this University Lease, the Parties acknowledge and agree that all payments to the Operator pursuant to any agreement between UMLLC or the Concessionaire and the Operator to operate the Utility System that have been previously Approved by the University on or prior to the Turnover Date, shall be deemed Approved and shall require no further Approval for any Five-Year Plan, provided that such payments do not materially differ from the payments or payment mechanics that were Approved by the University in its Approval of the Operator or otherwise.
- (i) In acknowledgement of the importance of the Utility System to the operation of the University Campus and the integrated delivery of services to students, employees, staff, faculty and visitors of the University Campus, the University Liaison and other University Representatives selected by the University will meet with a representative of UMLLC, the Concessionaire and the Operator on a quarterly basis in order to discuss and assess the implementation of the then-current Five-Year Plan, including any delays or failures to meet the then-current Five-Year Plan and discuss the development of the immediately subsequent Five-Year Plan.

Section 7.3. Energy and Water Supply.

- (a) UMLLC shall assist the University with the procurement of sufficient electricity, natural gas, biomass, or other energy supply inputs and domestic water necessary to fully operate the Utility System as set forth in the Performance Standards (the "Supplies"). At the University's direction, assistance may include, but not be limited to, identification and development of Supply procurement opportunities, provision of market analysis and advice regarding the same, acting on behalf of the University to negotiate or assist in negotiating Supply purchases, acting on behalf

of the University, or assisting the University in the operation of bidding mechanisms to procure competitive retail Supplies. The University shall be responsible for paying all Supply Costs directly to the vendor of such Supplies. The University, in connection with its commitment to sustainability, minimization of environmental impact, responsible energy procurement, and its rights and responsibilities as the energy Supply customer of record, shall enter into any contracts with a third party for providing Supplies to the Utility System (each, a “Supply Contract”); *provided* that the University shall have made a reasonable determination that each such Supply Contract is consistent with the then-current Approved Five-Year Plan or has issued a University Directive with respect to such Supply Contract. The University shall, in its sole discretion, determine the types and sources of the Supplies and the appropriate entity (among UMLLC, the Concessionaire, the Operator and the University) to execute each Supply Contract and, if applicable, any Authorization related to Supplies, with UMLLC, the Concessionaire or Operator executing pursuant to a power of attorney, and UMLLC shall operate the Utility System consistent with the types and sources of Supplies determined by the University. In any case, regardless of which entity executes a Supply Contract, the University will be considered as the exclusive customer of the Supplies procured pursuant to this Section 7.3(a) or used for the operation of the Utility System. Notwithstanding the foregoing, the Parties acknowledge that as of the Time of Turnover, there shall be in place certain Supply Contracts to provide Supplies as described in Schedule 6, and UMLLC’s obligations under this Section 7.3(a) with respect to the Supplies which are the subject of such Supply Contract shall be met by managing those Supply Contracts until their expiration or termination, at which time UMLLC shall be responsible for assisting the University with the procurement of those Supplies for the University Campus as provided herein immediately following the expiration or termination of those Supply Contracts. For the avoidance of doubt, if the third-party supplier of the Supplies fails to deliver such Supplies pursuant to the applicable Supply Contract, (i) such failure shall be a Delay Event (except with respect to any failure to deliver Supplies on University locations outside of the University Campus), (ii) UMLLC acting on behalf of the University shall use commercially reasonable efforts to cause such third-party supplier to deliver such Supplies as soon as reasonably practicable, and (iii) as necessary, assist the University with the prompt replacement of such third-party supplier.

- (b) UMLLC shall, upon written notice from the University, be responsible for assisting the University with the procurement, billing and/or management of Supplies to the University or its Affiliates on University locations outside of the University Campus, and such assistance with the procurement, billing and/or management of Supplies shall be deemed part of the Utility System Operations. For clarification purposes, UMLLC shall be responsible for assisting the University with the management of Supplies under any existing Supply Contract described in Schedule 6 as provided in Section 7.3(a).
- (c) UMLLC shall ensure that any Supply Contracts negotiated by UMLLC provide that invoices are remitted to UMLLC, if so requested by the University in writing, or to

such other entity as identified by the University. Promptly after receipt of such an invoice for Supply Costs from a third party but in no event more than five (5) Business Days after receipt thereof, UMLLC shall forward the supplier's invoice to the University, and UMLLC shall have no obligation to pay such Supply Costs.

- (d) UMLLC shall cause the Utility System to be operated using a mix of Supplies supported by the then-current Supply Contracts and the Approved Five-Year Plan. UMLLC shall consult the University with respect to any adjustments to the mix of Supplies required to operate the Utility System in accordance with this University Lease and any such adjustments shall only be made upon Approval from the University, which may be withheld in its sole discretion.

Section 7.4. Energy Use Intensity Reduction and Energy Conservation Measures.

In furtherance of the objectives set forth in Section 3.27, within two (2) Years after the Turnover Date, the University shall have the right to request in writing that UMLLC diligently prepare and provide to the University a detailed study with recommendations and proposals for opportunities to reduce the energy use intensity on the University Campus, and UMLLC shall in good faith discuss with the University UMLLC implementing such recommendations and proposals. In addition, in connection with each Five-Year Plan, UMLLC may propose certain measures or improvements on the University Campus, including energy conservation measures, buying strategies in connection with Supplies, or such other improvements anticipated to achieve an energy use intensity reduction. The University may consider such proposals in its discretion in connection with reviewing such Five-Year Plan and any Approval of the same may include a shared savings of costs with respect thereto.

**ARTICLE 8
REPORTING; AUDITS; INSPECTIONS**

Section 8.1. Reports; Environmental Incident Management.

- (a) *Incident Management and Notifications.* UMLLC shall (i) provide notice to the University of all Emergencies as promptly as possible, and, in any event, not later than six (6) hours after UMLLC, the Concessionaire or the Operator becomes aware of the Emergency, and (ii) promptly provide notice to the University of all material accidents and incidents occurring with respect to the Utility System and of all claims in excess of twenty-five thousand dollars (\$25,000) annually made by or against UMLLC or potential claims in excess of twenty-five thousand dollars (\$25,000) annually that UMLLC reasonably expects to make against, or to be made against it by, third parties.
- (b) *Environmental Incident Management and Notifications.* UMLLC shall provide notice to the University as promptly as possible, and, in any event, not later than six (6) hours after UMLLC becomes aware of the Release (accidental or otherwise) of any reportable quantity, as defined under applicable Environmental Law, of Hazardous Substances occurring with respect to the Utility System or otherwise on the University Campus or any part thereof, which notice shall include the time of such Release, the agencies involved, the damage that has occurred and the remedial

action taken. UMLLC shall be financially responsible and shall pay the costs and expenses of any remediation required as a result of any such Release of Hazardous Substances caused by the willful misconduct or negligent action of, or permitted by the negligent inaction of, UMLLC or any of its Representatives, which costs shall not be recoverable by UMLLC as part of the Utility Fee or otherwise pursuant to this University Lease, and UMLLC shall not be financially responsible for other Releases of Hazardous Substances from the Utility System. Regardless of the foregoing, unless such Release is an Excluded Liability, UMLLC shall be responsible for the remediation of any Releases of Hazardous Substances from the Utility System. UMLLC shall not be financially responsible for the actions or inactions of third parties except for (i) those actions or inactions with respect to which UMLLC or any of its Representatives shall have had prior knowledge of and could have used commercially reasonable efforts to prevent or mitigate and (ii) those actions or inactions consented in writing to or directed in writing by UMLLC or any of its Representatives. As between the University and UMLLC, the University shall be designated the generator for the disposal of all Hazardous Substances or other contamination, except for any Hazardous Substances that were Released by the willful misconduct or negligent action of, or permitted by the negligent inactions of, UMLLC, the Concessionaire, the Operator or any of their respective Representatives.

- (c) *Financial Reports.* UMLLC shall deliver to the University within one hundred twenty (120) Days after the end of each Fiscal Year a copy of the audited balance sheets of UMLLC at the end of each such Fiscal Year and the related audited statements of income, changes in equity and cash flows for such Fiscal Year, including, in each case, the notes thereto, together with the report thereon of the independent certified public accountants of UMLLC, in each case in a manner and containing information consistent with UMLLC's current practices and certified by UMLLC's chief financial officer that such financial statements fairly present the financial condition and the results of operations, changes in equity and cash flows of UMLLC as of the respective dates of and for the periods referred to in such financial statements, all in accordance with GAAP or IFRS, provided that if such financial statements are prepared in accordance with IFRS, such financial statements shall include a reconciliation statement setting forth any material discrepancies between IFRS and GAAP reporting with respect to the subject matter thereof. UMLLC's independent certified public accountants shall be subject to the University's Approval.
- (d) *Utility Fee Reports.* UMLLC shall deliver to the University within thirty (30) Days after the end of each Quarter during a Fiscal Year a report showing (i) the calculation of the Variable Fee Component for that Quarter, (ii) the amount of Uncapped O&M Costs incurred to date for such Fiscal Year, and (iii) the anticipated expenditures on Capital Improvements and Material Changes for the remainder of such Fiscal Year.

- (e) *Regular Reports.* UMLLC shall deliver to the University all reports and information as set forth in the Performance Standards in the time and format described in the Performance Standards.

Section 8.2. Information.

- (a) *Furnish Information.* At the request of the University, UMLLC shall, at UMLLC's cost and expense and at any and all reasonable times during the Term: (i) make available or cause to be made available (and, if requested by the University, furnish or cause to be furnished) to the University all information relating to the Utility System Operations, this University Lease or the Utility System as may be specified in such request and as shall be in the possession or control of UMLLC or its Representatives, and (ii) permit the University, after giving ten (10) Business Days' prior notice to UMLLC (which notice shall identify the Persons the University requests to be present for an interview and describe with reasonable specificity the subject matter to be raised in the interview) to request UMLLC's approval, which approval shall not be unreasonably withheld, conditioned, or delayed, to discuss the obligations of UMLLC under this University Lease with any of the directors, officers, employees or managers of UMLLC, the Concessionaire, the Operator or their respective Representatives at times and places on the University Campus acceptable to all attendees (it being agreed that UMLLC shall have the right to be present during any such discussions with the Operator or Representatives of UMLLC, the Concessionaire or the Operator), for the purpose of enabling the University to determine whether UMLLC is in compliance with this University Lease. For the avoidance of doubt, this Section 8.2(a) does not impose a requirement to retain information not otherwise retained in the normal course of business or required to be retained by applicable Law.
- (b) *Confidentiality.* Unless disclosure is required by applicable Law, the University shall keep confidential any information obtained from UMLLC or its Representatives that constitutes a "trade secret" as defined by applicable Law, as determined by the University in its reasonable discretion. In the event that UMLLC seeks to defend an action seeking the disclosure of information that UMLLC determines to be confidential pursuant to this Section 8.2(b), the University shall use commercially reasonable efforts to cooperate in such action at no out-of-pocket cost to the University, provided that the University shall not be required to institute any legal action against the requesting party. Notwithstanding anything to the contrary herein, the University and UMLLC may disclose the United States federal tax treatment and tax structure of the Transaction.

Section 8.3. Inspection, Audit and Review Rights of the University.

- (a) *Audit Right.* In addition to the rights set out in Section 7.1(c) and Section 8.2, the University may, at all reasonable times, upon ten (10) Business Days' prior notice, cause a Representative designated by it to carry out an Audit and Review of the information required to be maintained or delivered by UMLLC under this University Lease in connection with the performance of the Utility System

Operations for the purpose of verifying the information contained therein verifying Utility System Operations and to otherwise track utility usage patterns and shall be entitled to make copies thereof and to take extracts therefrom, at the University's expense but, in any event, subject to Section 8.2(b). UMLLC shall, at reasonable times, make available or cause to be made available to the University or its designated Representative such information and material as may reasonably be required by the University or its designated Representative for its purposes and otherwise provide such cooperation as may be reasonably required by the University in connection with the same. Such audits may be made on either a continuous or a periodic basis or both, and may be conducted by (1) employees of the University, (2) by independent auditors retained by the University, or (3) to the extent required by Law (including La. R.S. 24:511 *et seq.*), by or on behalf of the Louisiana Legislative Auditor or by the Office of the Governor or Division of Administration of the State of Louisiana.

- (b) *Inspection Right.* The University and its Representatives shall, at all reasonable times and upon reasonable prior notice and subject to UMLLC's reasonable safety requirements and protocols, have access to the Utility System, the D&C Work, and every part thereof, and UMLLC, at the reasonable cost and expense of UMLLC, shall and shall cause its Representatives to furnish the University with every reasonable assistance for inspecting the Utility System, the D&C Work, and the Utility System Operations for the purpose of Auditing and Reviewing the information relating to the Utility System Operations and the D&C Work or ascertaining compliance with this University Lease and applicable Law subject to reasonable restrictions on access to confidential and proprietary information as determined by UMLLC.
- (c) *Tests.* The University and its Representatives shall, with the prior consent of UMLLC, which consent shall not be unreasonably withheld, conditioned or delayed, be entitled, at the sole cost and expense of the University and at any time and from time to time, to perform or cause to be performed, in accordance with Prudent Industry Practices, any test, study or investigation in connection with the Utility System, the D&C Work, or the Utility System Operations as the University may reasonably determine to be necessary in the circumstances, and UMLLC, at the cost and expense of UMLLC, shall, and shall cause its Representatives to, furnish the University or its Representatives with reasonable assistance in connection with the carrying out of such tests, procedures, studies and investigations.
- (d) *No Waiver.* Failure by the University or its Representatives to inspect, review, test or Audit and Review UMLLC's responsibilities under this University Lease or any part thereof, or the performance by UMLLC of the Utility Services, or the information relating to the Utility System Operations, shall not constitute a waiver of any of the rights of the University hereunder or any of the obligations or liabilities of UMLLC hereunder. Inspection, review, testing or Audit and Review not followed by a notice of UMLLC Default shall not constitute a waiver of any

UMLLC Default or constitute an acknowledgement that there has been or will be compliance with this University Lease and applicable Law.

- (e) *No Undue Interference.* In the course of performing its inspections, reviews, tests, and Audits and Reviews hereunder, the University shall minimize the effect and duration of any disruption to or impairment of the Utility System Operations or UMLLC's rights or responsibilities under this University Lease, having regard to the nature of the inspections, reviews, tests, and Audits and Reviews being performed, except as necessary in the case of investigations of possible criminal conduct or the University ordinance violations.

Section 8.4. Audits, Assistance, Inspections and Approvals. Wherever in this University Lease reference is made to the University or its Representatives providing assistance, services, Approvals, or consents to or on behalf of UMLLC or its Representatives or to the University or its Representatives performing an Audit and Review or inspecting, testing, reviewing, or examining the Utility System, the Utility System Operations or any part thereof or the books, records, Documents, budgets, proposals, requests, procedures, certificates, plans, drawings, specifications, contracts, agreements, schedules, reports, lists, or other instruments of UMLLC or its Representatives, such undertaking by the University or its Representatives shall not relieve or exempt UMLLC from, or represent a waiver of, any requirement, liability, UMLLC Default, covenant, agreement, or obligation under this University Lease or at law or in equity and shall not create or impose any requirement, liability, covenant, agreement, or obligation (including an obligation to provide other assistance, services, or Approvals) on the University or its Representatives not otherwise created or imposed pursuant to the express provisions of this University Lease.

Section 8.5. Review and Audit of Costs Relating to D&C Work. Prior to making any progress payments or final payment to the D&C Contractor in respect of the D&C Work pursuant to the terms of the Drop-Down DB Contract, UMLLC shall provide the University and its Representatives with the opportunity to review and comment on the relevant draw or payment request from the D&C Contractor for purposes of verifying that the payment amount requested corresponds with the D&C Work performed during the relevant period. The University and its Representatives, as applicable, will provide comments on the relevant draw or payment request within five (5) Business Days of the receipt of same from UMLLC. UMLLC shall not make payment to the D&C Contractor until the University's comments on the relevant draw or payment request, if any, have been resolved to the satisfaction of the University, acting reasonably. Following IMP Final Acceptance and final payment to the D&C Contractor, the University or its Representatives shall be entitled to carry out an Audit and Review of all payments in respect of the D&C Work made to the D&C Contractor pursuant to the terms of the Drop-Down DB Contract in order to, among other things, verify the Capital Improvement Cost of the Initial Modernization Project as compared to the Approved Budgeted Amount for the Initial Modernization Project. Such Audit and Review may be conducted by (1) employees of the University, (2) by independent auditors retained by the University, or (3) to the extent required by Law (including La. R.S. 24:511 *et seq.*), by or on behalf of the Louisiana Legislative Auditor or by the Office of the Governor or Division of Administration of the State of Louisiana.

ARTICLE 9
REPRESENTATIONS AND WARRANTIES

Section 9.1. Representations and Warranties of the University. The University makes the following representations and warranties to UMLLC and acknowledges that UMLLC and its Representatives are relying upon such representations and warranties in entering into this University Lease:

- (a) *Organization.* LSU is the flagship institution of the State of Louisiana under the management and supervision of the Board, which Board is a public constitutional corporation organized and existing under the laws of the State of Louisiana.
- (b) *Power and Authority.* The University has (i) duly authorized and approved the execution and delivery of this University Lease and (ii) duly authorized and approved the performance by UMLLC of its obligations contained in this University Lease. The University has the power and authority to enter into this University Lease and to do all acts and things and execute and deliver all other documents as are required hereunder to be done, observed or performed by it in accordance with the terms hereof.
- (c) *Enforceability.* This University Lease has been duly authorized, executed, and delivered by the University and constitutes a valid and legally binding obligation of the University, enforceable against the University in accordance with the terms hereof, subject only to applicable bankruptcy, insolvency, and similar laws affecting the enforceability of the rights of creditors generally and to general principles of equity.
- (d) *Title.* The University has good and sufficient ownership interest in the Utility Facilities, the Utility System Land, and the Utility System Assets necessary for the Utility System Operations pursuant to this University Lease, subject only to Permitted University Encumbrances, and is able to transfer or grant such interest to UMLLC as provided in this University Lease. Subject to any and all Permitted University Encumbrances and to the Actual Knowledge of the University, there is no recorded or unrecorded agreement, contract, option, commitment, right, privilege, or other right of another binding upon, or which at any time in the future may become binding upon, the University to sell, transfer, convey, subject to lien, charge, grant a security interest in, or in any other way dispose of or materially encumber the Utility System. Subject to any and all Permitted University Encumbrances and to the Actual Knowledge of the University, the recorded or unrecorded restrictions, exceptions, easements, rights of way, reservations, limitations, interests, and other matters that affect title to the Utility System (or any portion thereof) do not materially adversely affect UMLLC's ability to operate the Utility System in accordance with the terms hereof. No indebtedness for borrowed money of the University is or will be secured by any right or interest in the Utility System or the revenues or income therefrom, and no Person will have any claim or right to, or interest in, any income, profits, rents, or revenue derived by UMLLC from or generated with respect to the Utility System (other than UMLLC and any

claims, rights, or interests granted by or otherwise relating to UMLLC); *provided, however*, the foregoing shall not apply to (i) revenues to which the University is or may be entitled to under this University Lease, (ii) revenues or income derived after the End Date, (iii) revenues or income received by the University from students, or (iv) revenues or income received by the University from third parties as reimbursement for Utilities received by such parties.

- (e) *No Conflicts.* The execution and delivery of this University Lease by the University, the consummation of the Transaction (including the operation of the Utility System in accordance with the terms of this University Lease), and the performance by the University of the terms, conditions, and provisions hereof have not and will not contravene or violate or result in a breach of (with or without the giving of notice or lapse of time, or both) or acceleration of any material obligations of the University under (i) any applicable Law, (ii) any agreement, instrument, or document to which UMLLC is a party or by which it is bound, or (iii) the University's governing documents.
- (f) *Consents.* No Consent that has not already been obtained is required to be obtained by the University from, and no notice or filing that has not already been given is required to be given by the University to, or made by the University with, any Person (including any Governmental Authority) in connection with the execution, delivery, and performance by the University of this University Lease or the consummation of the Transaction, except for such consents which have been obtained and notices which have been given.
- (g) *Compliance with Law; Litigation; Environmental Matters.*
 - (i) The University is not in breach of any applicable Law that would reasonably be expected to have a Material Adverse Effect or a material adverse effect on UMLLC. To the Actual Knowledge of the University, (A) the University is in compliance, in all material respects, with the terms and conditions of all Authorizations from Governmental Authorities, (B) no claim has been made by any Governmental Authority to the effect that an Authorization that the University has not obtained is necessary in respect of the operation of the Utility System, and (C) no additional Authorizations from any Governmental Authority are necessary for the operation of the Utility System as currently being operated.
 - (ii) To the Actual Knowledge of the University, the University has not been served with notice of any action, suit, or proceeding, at law or in equity, or before or by any Governmental Authority, and to the Actual Knowledge of the University, there is no such action, suit, or proceeding pending or threatened against the University, which would reasonably be expected to have a Material Adverse Effect or a material adverse effect on UMLLC. As of the date hereof, there is no action, suit, or proceeding, at Law or in equity, or before or by any Governmental Authority, pending nor, to the Actual Knowledge of the University, threatened, against the University which

could materially affect the validity or enforceability of this University Lease or the Concession Agreement.

- (iii) To the Actual Knowledge of the University, (a) there is no pending investigation by a Governmental Authority concerning any Release of Hazardous Substances in connection with the Utility System or the Utility Facilities and (b) there has been no Release of Hazardous Substances in connection with the Utility System or the Utility Facilities that could reasonably result in liability to UMLLC.
- (h) *Historical Financial Information.* The financial information relating to the Utility System attached hereto as Schedule 9, which identifies operational costs for the periods that ended June 30, 20[●] through June 30, 20[●], to the Actual Knowledge of the University, fairly presents the financial information disclosed thereon in accordance with standard accounting procedures of the University with respect to the Utility System, and is adjusted for anticipated expenditures UMLLC will incur to operate the Utility System as it is currently operated.
- (i) *Absence of Changes.* To the Actual Knowledge of the University, since June 30, 20[●], there has not been any transaction or occurrence that has resulted or is reasonably likely to result in a Material Adverse Effect or a material adverse effect on the University
- (j) *Brokers.* There is no investment banker, broker, finder, or other intermediary which has been retained by or is authorized to act on behalf of the University who might be entitled to any fee or commission from the University in connection with the Transaction. There is also no investment banker, broker, finder, or other intermediary which has been retained by or is authorized to act on behalf of the University who might be entitled to any fee or commission from UMLCC in connection with the Transaction.
- (k) *Accuracy of Information.* To the Actual Knowledge of the University, the factual and past historical information regarding the Utility System that the University provided to UMLLC through [●] was accurate in all material respects at the time such information was prepared, except to the extent the University removed, revised, or replaced such information prior to the Turnover Date.
- (l) *Undisclosed Defects.* To the Actual Knowledge of the University, there are no material defects of the Utility System that could reasonably be expected to prevent the Utility System from being operated in accordance with the Performance Standards and Prudent Industry Practices.

Section 9.2. Representations and Warranties of UMLLC. UMLLC makes the following representations and warranties to the University and acknowledges that the University and its Representatives are relying upon such representations and warranties in entering into this University Lease:

- (a) *Organization.* UMLLC is Louisiana limited liability company.

- (b) *Power and Authority.* UMLLC has (i) duly authorized and approved the execution and delivery of this University Lease and (ii) duly authorized and approved the performance by UMLLC of its obligations contained in this University Lease. UMLLC has the power and authority to enter into this University Lease and to do all acts and things and execute and deliver all other documents as are required hereunder to be done, observed or performed by it in accordance with the terms hereof.
- (c) *Enforceability.* This University Lease has been duly authorized, executed, and delivered by UMLLC and constitutes a valid and legally binding obligation of UMLLC, enforceable against UMLLC in accordance with the terms hereof, subject only to applicable bankruptcy, insolvency, and similar laws affecting the enforceability of the rights of creditors generally and to general principles of equity.
- (d) *No Conflicts.* The execution and delivery of this University Lease by UMLLC, the consummation of the Transaction (including the operation of the Utility System in accordance with the terms of this University Lease), and the performance by UMLLC of the terms, conditions, and provisions hereof have not and will not contravene or violate or result in a breach of (with or without the giving of notice or lapse of time, or both) or acceleration of any material obligations of UMLLC under (i) any applicable Law, (ii) any agreement, instrument, or document to which UMLLC is a party or by which it is bound, or (iii) UMLLC's governing documents.
- (e) *Consents.* No Consent that has not already been obtained is required to be obtained by UMLLC from, and no notice or filing that has not already been given is required to be given by UMLLC to or made by UMLLC with, any Person (including any Governmental Authority) in connection with the execution, delivery, and performance by UMLLC of this University Lease or the consummation of the Transaction, except for such consents which have been obtained and notices which have been given.
- (f) *Compliance with Law; Litigation.*
- (i) UMLLC is not in breach of any applicable Law that would reasonably be expected to have a Material Adverse Effect or a material adverse effect on the University. UMLLC is in compliance, in all material respects, with the terms and conditions of all Authorizations from Governmental Authorities, no claim has been made by any Governmental Authority to the effect that an Authorization that UMLLC has not obtained is necessary in respect of the operation of the Utility System, and no additional Authorizations from any Governmental Authority are necessary for the operation of the Utility System as currently being operated.
 - (ii) UMLLC has not been served with notice of any action, suit, or proceeding, at law or in equity, or before or by any Governmental Authority, and there is no such action, suit, or proceeding pending or threatened against UMLLC which would reasonably be expected to have a Material Adverse Effect or

a material adverse effect on the University. As of the date hereof, there is no action, suit, or proceeding, at Law or in equity, or before or by any Governmental Authority, pending nor threatened against UMLLC which could materially affect the validity or enforceability of this University Lease or the Concession Agreement.

- (g) *Absence of Changes.* Since June 30, 20[●], there has not been any transaction or occurrence that has resulted or is reasonably likely to result in a Material Adverse Effect or a material adverse effect on the University.
- (h) *Accuracy of Information.* To the actual knowledge of UMLLC, (i) all information regarding UMLLC provided to the University by or on behalf of UMLLC was accurate in all material respects at the time such information was provided.
- (i) *Brokers.* There is no investment banker, broker, finder, or other intermediary which has been retained by or is authorized to act on behalf of UMLLC who might be entitled to any fee or commission from UMLLC in connection with the Transaction. There is also no investment banker, broker, finder, or other intermediary which has been retained by or is authorized to act on behalf of UMLLC who might be entitled to any fee or commission from the University in connection with the Transaction.

Section 9.3. Non-Waiver. No investigations made by or on behalf of any Party at any time shall have the effect of waiving, diminishing the scope of, or otherwise affecting any representation or warranty made by the other Party in this University Lease or pursuant to this University Lease. No waiver by a Party of any condition, in whole or in part, shall operate as a waiver of any other condition.

Section 9.4. Survival.

- (a) *The University's Representations and Warranties.* The representations and warranties of the University contained in Section 9.1 shall survive and continue in full force and effect for the benefit of UMLLC as follows: (i) as to the representations and warranties contained in Sections 9.1(a) through 9.1(g), inclusive, without time limit; and (ii) as to all other matters, for a period of twenty-four (24) months following the Turnover Date unless a bona fide notice of a Claim shall have been given, in writing, in accordance with Section 20.1, prior to the expiry of that period, in which case the representation and warranty to which such notice applies shall survive in respect of that Claim until the final determination or settlement of that Claim, provided such determination or settlement is being pursued diligently and in good faith by the applicable Party.
- (b) *UMLLC's Representations and Warranties.* The representations and warranties of UMLLC contained in Section 9.2 shall survive and continue in full force and effect for the benefit of the University without time limit.
- (c) *Modification of Statutes of Limitations.* The survival periods set forth in this Section 9.4 shall apply with respect to all Claims notwithstanding any statute of limitations or prescriptive period that would be applicable to such Claims under

applicable Law. The Parties acknowledge and agree that they intend to modify the statutes of limitations and prescriptive periods with respect to all Claims to the extent such statutes of limitations or prescriptive periods would conflict with the provisions set forth in this Section 9.4.

ARTICLE 10 FINANCE OBLIGATIONS

Section 10.1. UMLLC's Obligations. UMLLC shall be responsible for obtaining any financing for the performance of its obligations under this University Lease, which financing shall comply with all requirements of this University Lease, and which financing shall be subject to the University's prior written approval, in its sole discretion. To the extent so approved by the University, UMLLC shall be permitted to issue additional Leasehold Mortgage Debt or refinance existing Leasehold Mortgage Debt at any time during the Term provided that, as a condition thereof, UMLLC must comply with Section 3.6 in connection therewith.

Section 10.2. University's Obligations. The University shall, to the extent consistent with applicable Law and at the sole cost and expense of UMLLC, cooperate with UMLLC with respect to documentation reasonably necessary to obtain, maintain, and replace financing for the performance of the obligations of UMLLC hereunder. The University's cooperation may include reviewing, Approving, and executing documents which substantiate the terms of this University Lease (including any consents or agreements necessary to confirm that the debt evidenced by the relevant financing constitutes a Leasehold Mortgage Debt) and making information and material relating to the Utility System Operations available to any of UMLLC's lenders or proposed lenders to facilitate financing to the extent permitted by applicable Law and contractual obligations with third parties and to the extent reasonable in the circumstances, provided that such lenders and potential lenders shall hold such information in confidence (provided that such lenders and potential lenders may disclose such information to Affiliates and their respective officers, employees, agents, advisors, stockholders, partners, members, accountants, and attorneys to the extent the foregoing agree to maintain such information as confidential in accordance with this Section 10.2 or as may be compelled in a judicial, regulatory (including any self-regulatory organization), or administrative proceeding or as otherwise required by applicable Law or required by any Governmental Authority having jurisdiction over the lender) and UMLLC shall be liable for any disclosure by such lenders or potential lenders in breach thereof. If requested in writing to do so by UMLLC, the University shall, at the sole cost and expense of UMLLC, use its commercially reasonable efforts to cause the University's independent public accountants to reasonably cooperate in connection with UMLLC's public or private offering of securities, as the case may be. In addition, the University shall, promptly upon the request of UMLLC or any Leasehold Mortgagee, execute, acknowledge, and deliver to UMLLC, or any of the parties specified by UMLLC, standard consents and estoppel certificates with respect to this University Lease which may be qualified, after reasonable diligence, to the best of the knowledge and belief of a designated Representative of the University. Nothing herein shall require the University to incur any additional obligations or liabilities (unless the University shall have received indemnification, as determined in the University's discretion, with respect thereto), to take any action or give any consent or enter into any document inconsistent with the provisions of this University Lease.

Section 10.3. UMLLC’s Obligation for Estoppel Certificates. UMLLC shall, promptly upon the request of the University, execute and deliver to the University, or any of the parties specified by the University, standard consents and estoppel certificates with respect to this University Lease which may be qualified to the best of the knowledge and belief of a designated Representative of UMLLC. Nothing herein shall require UMLLC to incur any additional obligations or liabilities or to take any action, give any consent, or enter into any document inconsistent with the provisions of this University Lease or applicable Law.

Section 10.4. Prohibited Tax Shelter Transactions. Consistent with Section 9.2(g), UMLLC covenants and agrees that it shall not enter into any lease, sublease, concession, management agreement, operating agreement, or other similar arrangement or other transaction that would cause the University to become a party to a “prohibited tax shelter transaction” within the meaning of Section 4965 of the Code. A violation of this Section 10.4 or a breach of the representation set forth in Section 9.2(g) by UMLLC shall entitle the University to (a) recover from UMLLC the amount of any Tax liability, penalty, or loss to which the University or any University official is subject and (b) require UMLLC, at UMLLC’s expense, to prepare timely all statements and returns, and to maintain all lists and similar information that the University becomes obligated to disclose, file, or maintain with any taxing authority or participant or otherwise as a result of such transaction.

Section 10.5. Concessionaire Leasehold Mortgage Debt. The University and UMLLC agree and acknowledge that the Concession Agreement allows the Concessionaire the right to obtain “Leasehold Mortgage Debt” (as such term is defined and used in the Concession Agreement) in accordance with the express terms and conditions of Article 10 of the Concession Agreement. The University agrees to reasonably cooperate with UMLLC and Concessionaire with any such Leasehold Mortgage Debt sought by the Concessionaire in accordance with the relevant terms and conditions of the Concession Agreement (including Article 10 thereof), in each case consistent with the University’s obligations under Article 10 of this University Lease as the same would apply to Leasehold Mortgage Debt approved by the University as contemplated in Section 10.1 hereof, but subject in all cases to the relevant terms, conditions and obligations of the Concessionaire set forth in the Concession Agreement with respect thereto.

ARTICLE 11 COMPLIANCE

Section 11.1. Compliance with Laws. UMLLC must at all times at its own cost and expense (but subject to UMLLC’s express rights hereunder with respect to such costs and expenses, including its right to include the reasonable cost of compliance with any Law enacted after the Turnover Date in the Uncapped O&M Costs in accordance with the definition thereof) observe and comply, in all material respects, and cause the Utility System Operations to observe and comply, in all material respects, with all applicable Laws now existing or later in effect, including those Laws expressly enumerated in this Article 11, and those that may in any manner apply with respect to the performance of UMLLC’s obligations under this University Lease. For the avoidance of doubt, any costs incurred to comply with applicable Law as a result of any Capital Improvement or other alteration to the Utility System undertaken by UMLLC, shall be at UMLLC’s cost (subject to inclusion in the Utility Fee as part of the Variable Fee Component or Uncapped O&M Costs, if and as applicable). UMLLC shall notify the University within seven (7)

Days after receiving written notice from a Governmental Authority that UMLLC, the Concessionaire or the Operator may have violated any Laws.

Section 11.2. Non-Discrimination.

- (a) *Non-Discrimination Requirements.* UMLLC shall comply with, and maintain employment policies in a manner consistent with, all applicable Laws regarding equal employment opportunity and non-discrimination in employment, including: (i) the Civil Rights Act of 1964, 42 U.S.C. § 2000 et seq. (1981); (ii) the Civil Rights Act of 1991, P.L. 102-166; (iii) Executive Order Number 11246, 30 Fed. Reg. 12,319 (1965), reprinted in 42 U.S.C. § 2000(e) note, as amended by Executive Order Number 11375, 32 Fed. Reg. 14,303 (1967) and by Executive Order Number 12086, 43 Fed. Reg. 46,501 (1978); (iv) the Age Discrimination Act, 42 U.S.C. §§ 6101-6106 (1981); (v) the Age Discrimination in Employment Act, 29 U.S.C. §§ 621-34 (1967); (vi) the Rehabilitation Act of 1973, 29 U.S.C. §§ 793-794 (1981); (vii) the Americans with Disabilities Act, 42 U.S.C. § 12101 et seq. (1990); (viii) the Uniformed Services Employment and Reemployment Rights Act, 38 U.S.C. § 4301 et seq.; (ix) the Louisiana Human Rights Act, La. R.S. 51:2231 et seq.; and (ix) the Louisiana Employment Discrimination Law, La. R.S. 23:301 et seq.
- (b) *Contract Provisions.* UMLLC shall cause all Contractors to comply with each of the federal Laws and Louisiana Laws referenced in this Section 11.2, and shall include a provision to such effect in each contract entered into with any Contractor.

Section 11.3. Compliance with Wage and Hour Laws. UMLLC shall comply with all applicable Laws governing employment and/or employee wages and hours, including: (i) the Fair Labor Standards Act, 29 U.S.C. § 201 et seq.; and (ii) the Louisiana Payment of Employees Statute, La. R.S. 23:631 et seq.

Section 11.4. Safety Laws. UMLLC shall comply with and maintain employment policies in a manner consistent with all applicable Laws regarding workplace safety, including the Occupational Safety and Health Act of 1970, 29 U.S.C. § 651 et seq.

Section 11.5. Immigration Laws. UMLLC shall comply with and maintain employment policies in a manner consistent with all applicable Laws regarding lawful employment of U.S. citizens and non-U.S. citizens, including taking reasonable steps to verify the employment eligibility of all employees as required under such Laws.

Section 11.6. Labor Disputes. UMLLC shall take all reasonable steps to resolve any alleged or actual labor dispute between it or the Operator and any representative of its or the Operator's employees; further, any work stoppage or strike resulting from such labor dispute shall not excuse UMLLC's performance under this University Lease. The UMLLC shall use good faith efforts and take immediate steps to effect the limitation and/or removal, by lawful means, of any pickets or picketing that are the result of an alleged or actual labor dispute between it and any representative of its employees; provided however, if such pickets or picketing results in the obstruction of ingress or egress of any Public Way or University facility, UMLLC shall

immediately seek injunctive relief to terminate such pickets or picketing that may be available under applicable Laws.

Section 11.7. Employee Conduct and Performance. UMLLC shall ensure that it and the Operator have workplace conduct policies for their employees providing services under this University Lease that are at least as stringent as substantially similar policies and enforcement provisions as those of the University's general policies for conduct in the workplace and are in accordance with Prudent Industry Practices. These policies shall include policies related to workplace behavior; anti-harassment; weapons; confidentiality; security and safety; possession of alcohol; illegal drugs or weapons in the workplace; violation of criminal statutes that have a direct relationship to work performed by the employee; negligent or incompetent performance of work hereunder; gross misconduct related to work; conduct or interactions with University employees, students or visitors that impair or prejudice the University or its relationship with such persons; and unsafe practices or work performance that create a risk of harm to the employee, other persons or property.

Section 11.8. Non-Collusion. By signing this University Lease, UMLLC duly swears, affirms, and warrants that it is the contracting party, and that it has not, nor has any other member, employee, Representative, agent, or officer of the firm, company, corporation, or partnership represented by it, directly or indirectly entered into or offered to enter into any combination, conspiracy, collusion, or agreement to receive or pay any sum of money or other consideration for the execution of this University Lease other than that which appears upon the face of this University Lease.

Section 11.9. Conflict of Interest. UMLLC certifies and warrants to the University that neither it nor any of its agents, Representatives, or employees who will participate in any way in the performance of UMLLC's obligations hereunder has or, for so long as any such person continues in such capacity, will have any conflict of interest, direct or indirect, with the University during the performance of this University Lease, other than in respect of any disputes that may arise hereunder or in connection herewith.

Section 11.10. Drug-Free Workplace Certification. UMLLC hereby covenants and agrees to make a good faith effort to provide and maintain a drug-free workplace. UMLLC will give written notice to the University within seven (7) Days after receiving actual notice that UMLLC or an employee of UMLLC has been convicted of a criminal drug violation occurring in UMLLC's workplace.

Section 11.11. Diverse Businesses. UMLLC and its Representatives shall use good faith and commercially reasonable efforts to provide opportunities to minority- and women-owned and small and historically underutilized businesses (collectively, "Diverse Businesses") that are either certified by the State or another certifying entity in a diverse category as a contractor, subcontractor, supplier, or capital provider. UMLLC and its Representatives shall (i) implement the Diversity, Inclusion and Equity Plan attached hereto as Schedule 17 (the "Diversity Plan"), which Diversity Plan outlines UMLLC's commitment and obligation to provide opportunities to Diverse Businesses, (ii) provide to the University on a quarterly basis during the Term a list of all Diverse Businesses engaged or utilized in connection with any Capital Improvements, including but not limited to the Initial Modernization Project, which list shall identify as to each Diverse

Business contained thereon (A) the legal name thereof, (B) the principal office or address thereof, (C) ownership thereof, and (D) the services or good provided or supplied (or to be provided or supplied) and the value of the goods or services procured therefrom, and (iii) following written notice from the University, take all reasonable measures required by the University to ensure accountability, compliance, and transparency in complying with the commercially reasonable, the University system-wide disadvantaged business enterprise goals or policies established by the University's Office of Supplier Diversity. To the extent that any Law would require that this Section 11.11 or comparable language in this University Lease be modified or voided, the Parties agree that such provision can be amended or severed from any such agreement without affecting any of the other terms thereof.

Section 11.12. Accreditation. UMLLC shall ensure that the Utility System provides a sufficient quantity of Utilities in a timeframe sufficient such that the University may maintain any third-party accreditation or other third-party standard of which the University have provided UMLLC notice prior to the Turnover Date.

Section 11.13. Permits and Other Campus-Wide Authorizations. UMLLC acknowledges and agrees that, in connection with the Campus-Wide Permits: (i) the University will continue to be the "owner" identified in the Campus-Wide Permits during the Term; (ii) UMLLC will become the "operator" of permitted emission sources from the Utility System identified in the Campus-Wide Permits during the Term, to the extent applicable; (iii) UMLLC shall be responsible for operating all emission sources in compliance with all permit and regulatory requirements and meeting all monitoring, recordkeeping and reporting requirements related to such permitted emission sources; (iv) UMLLC shall promptly provide to the University's Office of Environmental Health and Safety, as the responsible University official for communications with the Louisiana Department of Environmental Quality ("DEQ"), all records that the DEQ inspectors request the University provide with respect to the Utility System; and (v) UMLLC shall provide to the University (a) complete drafts of all required reports with respect to the Utility System portion of the Campus-Wide Permits for the University to review and Approve at least 15 Business Days prior to the deadline to submit such reports, (b) any information regarding utility operations required for reports related to the Campus-Wide Permits by the later of (1) ten (10) Days after the end of the applicable reporting period and (2) (A) thirty (30) Days prior to the applicable submission deadline or (B) ten (10) Days after a University request not related to a submission deadline, (c) information to be submitted in connection with the renewal of the regulatory permits or any portion thereof within the time period reasonably established by the University and (d) applications for new permits or modifications to any Campus-Wide Permit for review and Approval at least thirty (30) Days prior to submission to a regulatory agency; and (v) the Parties shall reasonably cooperate with each other in connection with any matters relating to the Campus-Wide Permits. UMLLC shall comply with all Campus-Wide Permits to the extent applicable to the Utility System or Utility System Operations.

Section 11.14. Financial and Audit Standards. UMLLC shall comply, and its financial statements shall be prepared in accordance, with GAAP or IFRS, provided that if such financial statements are prepared in accordance with IFRS, such financial statements shall include a reconciliation statement setting forth any material discrepancies between IFRS and GAAP reporting with respect to the subject matter thereof.

Section 11.15. Pay If Paid; Non-Appropriation and Termination.

- (a) *Pay If Paid.* Notwithstanding anything to the contrary contained in this University Lease, whenever a provision in this University Lease provides (i) that the University shall only be entitled to compensation in the event and only to the extent that UMLLC receives the corresponding compensation under the Concession Agreement, (ii) that the University's entitlement to compensation shall be conditional upon and only to the extent that UMLLC receives the corresponding compensation under the Concession Agreement, (iii) that a payment or other compensation obligation of UMLLC is subject to the Pass-Down Provisions, or (iv) other similar language providing that a payment to the University is conditional upon receipt of the relevant amount by UMLLC from the Concessionaire, payment of the amount in question by the Concessionaire to UMLLC pursuant to the Concession Agreement will be strict conditions precedent to the obligation of UMLLC to make a payment to the University under the relevant provision of this University Lease.
- (b) *Non-Appropriation.* UMLLC acknowledges and agrees that the University's ability to make payments to UMLLC pursuant to this University Lease (including with respect to payment of the Utility Fee), require that the Legislature appropriate to the University funds sufficient therefor and to make such funds available to the University following appropriation. UMLLC has the right, pursuant to this University Lease, to cause the University to include in the University's annual budget request to the Legislature for each fiscal year of the University the funds necessary for payment of the amounts payable by the University to UMLLC pursuant to this University Lease. The University agrees to include such amounts in its annual budget request to the Legislature; but makes no representations, warranties or covenants, express or implied, that the Legislature will make such appropriations.
- (c) *Termination.* In the event the Legislature fails to appropriate sufficient moneys that would enable the University to pay its obligations to UMLLC to provide for the continuation of this University Lease, this University Lease shall terminate on the last day of that fiscal year, and the University shall adopt resolutions stating that there has been an event of non-appropriation. Such termination shall be without penalty or expense to the University or UMLLC; *provided, however*, that the University shall pay to UMLLC the amounts payable to UMLLC for termination pursuant to Section 16.4. In such event and for the avoidance of doubt, the University agrees to include in one or more of the University's annual budget request(s) to the Legislature the funds necessary for any such refunds and/or termination fees due UMLLC pursuant to this University Lease until such refunds and/or termination fees are paid in full.

ARTICLE 12 PAYMENT OBLIGATIONS

Section 12.1. Certain Payment Obligations of UMLLC. To the extent permitted by Law, UMLLC shall have a payment obligation to the University and each of its Representatives with respect to the full amount of any Losses actually suffered or incurred (as they are suffered or incurred) by the University or any such Representative, based upon, arising out of, related to, occasioned by or attributable to (i) any failure by UMLLC, the Concessionaire, the Operator, or each of their respective Representatives to comply with, observe, or perform any of the covenants, obligations, agreements, terms, or conditions in this University Lease or, subject to the expiration of the survival period specified in Section 9.4(b), any breach by UMLLC of its representations or warranties set forth herein, (ii) any Assumed Liabilities, (iii) any Tax or recording charge attributable to any Transfer of UMLLC Interest or any part thereof by UMLLC, (iv) any increase in Property Taxes payable by the University that is not included in the definition of Uncapped O&M Costs, or (v) any claim for brokerage commissions, fees, or other compensation by any Person who acted on behalf of UMLLC or its Representatives in connection with this University Lease, any Transfer of the UMLLC Interest or any part thereof, or any other matter affecting the Utility System; *provided, however*, that, except with respect to Claims resulting from Third Party Claims, subject to Section 12.5 Claims shall be made in writing within a period of three (3) Years following the expiration of the Term or earlier termination of this University Lease or within such shorter period as may be prescribed by the applicable statute of limitations or prescriptive period. The Parties agree that the Representatives of the University are intended to be third party beneficiaries of the obligations of UMLLC pursuant to this Article 12.

Section 12.2. Certain Payment Obligations of the University. To the extent permitted by Law, and without limiting any other remedy under this University Lease (including Concession Compensation or AA-Compensation as provided in this University Lease) the University shall have a payment obligation to UMLLC and each of its Representatives with respect to any Losses actually suffered or incurred by UMLLC or any such Representative, based upon, arising out of, related to, occasioned by, or attributable to (i) any failure by the University or any of its employees, officers, or agents (collectively, the “University Responsible Parties”) to comply with, observe, or perform any of the covenants, obligations, agreements, terms, or conditions in this University Lease or, subject to the expiration of the relevant survival period specified in Section 9.4(a), any breach by the University of its representations or warranties set forth herein, (ii) any Excluded Liabilities, (iii) any claim for brokerage commissions, fees, or other compensation by any Person who acted on behalf of the University or any University Responsible Party in connection with this University Lease or any other matter affecting the Utility System or (iv) any payment of Property Taxes with respect to the Utility System that are not the result of the actions or omissions of UMLLC and therefore not paid to UMLLC as Uncapped O&M Costs; *provided, however*, that, except with respect to Claims resulting from Third Party Claims, subject to Section 12.5 Claims are made in writing within a period of three (3) Years following the expiration of the Term or earlier termination of this University Lease or within such shorter period as may be prescribed by the applicable statute of limitations or prescriptive period. The Parties agree that the Representatives of UMLLC are intended to be third party beneficiaries of the obligations of the University pursuant to this Article 12.

Section 12.3. Agency for Representatives. Each of the University and UMLLC agrees that it accepts each payment obligation contemplated in this Article 12 in favor of any of its Representatives as agent and trustee of that Representative and agrees that each of the University and UMLLC may enforce a payment obligation in favor of its Representatives on behalf of that Representative. For purposes of this Section 12.3, the term “Representative”, in the case of UMLLC, includes the Leasehold Mortgagee.

Section 12.4. Third Party Claims.

- (a) *Notice of Third Party Claim.* If an Obligee receives notice of the commencement or assertion of any Third Party Claim, the Obligee shall give the Obligor reasonably prompt notice thereof, but in any event no later than 30 Days after receipt of such notice of such Third Party Claim. Such notice to the Obligor shall describe the Third Party Claim in reasonable detail (and include a copy of any complaint or related documents) and shall indicate, if reasonably practicable, the estimated amount of the Loss that has been or may be sustained by the Obligee.
- (b) *Defense of Third Party Claim.* The Obligor may participate in or assume the defense of any Third Party Claim by giving notice to that effect to the Obligee not later than thirty (30) Days after receiving notice of that Third Party Claim (the “Notice Period”). The Obligor’s right to do so shall be subject to the rights of any insurer or other Party who has potential responsibility with respect of that Third Party Claim. The Obligor agrees to pay all of its own expenses of participating in or assuming each defense. The Obligee shall cooperate in good faith in the defense of each Third Party Claim, even if the defense has been assumed by the Obligor and may participate in such defense assisted by counsel of its own choice at its own expense. If the Obligee has not received notice within the Notice Period that the Obligor has elected to assume the defense of such Third Party Claim, the Obligee may assume such defense, assisted by counsel of its own choosing and the Obligor shall be responsible for all reasonable costs and expenses paid or incurred in connection therewith and any Loss suffered or incurred by the Obligee with respect to such Third Party Claim.
- (c) *Assistance for Third Party Claims.* The Obligor and the Obligee will use all reasonable efforts to make available to the Party which is undertaking and controlling the defense of any Third Party Claim (the “Defending Party”), (i) those employees whose assistance, testimony, and presence is necessary to assist the Defending Party in evaluating and in defending any Third Party Claim, and (ii) all Documents, records and other materials in the possession of such Party reasonably required by the Defending Party for its use in defending any Third Party Claim, and shall otherwise co-operate with the Defending Party. The Obligor shall be responsible for all reasonable expenses associated with making such Documents, records and materials available and for all expenses of any employees made available by the Obligee to the Obligor hereunder, which expense shall not exceed the actual cost to the Obligee associated with such employees.

- (d) *Settlement of Third Party Claims.* If an Obligor elects to assume the defense of any Third Party Claim in accordance with Section 12.4(b), the Obligor shall not be responsible for any legal expenses subsequently incurred by the Obligee in connection with the defense of such Third Party Claim. However, if the Obligor fails to take reasonable steps necessary to defend diligently such Third Party Claim within thirty (30) Days after receiving notice from the Obligee that the Obligee believes on reasonable grounds that the Obligor has failed to take such steps, the Obligee may, at its option, elect to assume the defense of and to compromise or settle the Third Party Claim assisted by counsel of its own choosing and the Obligor shall be responsible for all reasonable costs and expenses paid or incurred in connection therewith. However, the Obligee shall not settle or compromise any Third Party Claim without obtaining the prior written consent of the Obligor unless such settlement or compromise is made without any responsibility to, and does not require any action on the part of, the Obligor and does not in any way affect the Obligor. In the event that the Obligee is the University, in no event may the Obligor settle or compromise any Third Party Claim without obtaining the prior written consent of the Obligee.

Section 12.5. Direct Claims. Any Direct Claim shall be asserted by giving the Obligor reasonably prompt notice thereof, but in any event not later than sixty (60) Days after the Obligee becomes aware of such Direct Claim. The Obligor shall then have a period of thirty (30) Days within which to respond in writing to such Direct Claim. If the Obligor does not so respond within such thirty (30) -Day period, the Obligor shall be deemed to have rejected such Direct Claim, and in such event the Obligee may submit such Direct Claim to the dispute resolution process set forth in Article 18.

Section 12.6. Failure to Give Timely Notice. A failure to give timely notice in accordance with this Article 12 shall not affect the rights or obligations of any Party except and only to the extent that, as a result of such failure, a Party which was entitled to receive such notice was deprived of its right to recover any payment under its applicable insurance coverage or was otherwise directly and materially damaged as a result of such failure. However, this Section 12.6 shall have no effect whatsoever on the survival provisions set out in Section 9.4 and the rights of the Parties with respect thereto.

Section 12.7. Reductions and Subrogation. If the amount of any Loss incurred by an Obligee at any time subsequent to the making of a payment hereunder on account of such Losses (an "Obligation Payment") is reduced by any recovery, settlement, or otherwise under or pursuant to any insurance coverage, or pursuant to any claim, recovery, settlement, or payment by or against any other Person, the amount of such reduction (less any costs, expenses (including Taxes) or premiums incurred in connection therewith), together with interest thereon from the date of such recovery, settlement, or reduction at the Bank Rate, shall promptly be repaid by the Obligee to the Obligor. Upon making a full Obligation Payment, the Obligor shall, to the extent of such Obligation Payment, be subrogated to all rights of the Obligee against any third party in respect of the Loss to which the Obligation Payment relates. Until the Obligee recovers full payment of its Loss, any and all claims of the Obligor against any such third party on account of such Obligation Payment shall be postponed and subordinated in right of payment to the Obligee's rights against such third party.

Section 12.8. Payment and Interest. All amounts to be paid by an Obligor hereunder, not including deductibles or self-insured retentions or insurance proceeds, shall bear interest at a rate per annum equal to the Bank Rate, calculated annually and payable monthly, both before and after judgment, from the date that the Obligee disbursed funds, suffered damages or losses, or incurred a loss or expense in respect of a Loss for which the Obligor is responsible to make payment pursuant to this Article 12, to the date of payment by the Obligor to the Obligee.

Section 12.9. Limitation on Certain Claims. To the extent permitted by Law and without limiting any other remedy under this University Lease (including Concession Compensation, AA-Compensation, or KPI Compensation as provided in this University Lease), the maximum aggregate liability of the University to UMLLC or its Representatives, in respect of Losses pursuant to this Article 12 shall not exceed the Maximum Budgeted IMP Amount; *provided* that this Section 12.9 shall not apply to Claims for: (i) breach of the representations or warranties in Sections 9.1(a), (b), (c), (d), (e), (f), (g), and (j); (ii) fraud, intentional misrepresentation, or intentional breach of the representations or warranties in Section 9.1; (iii) for any Excluded Liabilities referred to in Section 3.2(d)(iii)(2); (iv) payment of the Utility System Concession Value; and (v) payment of the Utility Fee. To the extent permitted by Law and without limiting any other remedy under this University Lease, the maximum aggregate liability of UMLLC to the University and its Representatives, in respect of Losses pursuant to this Article 12 shall not exceed the Maximum Budgeted IMP Amount; *provided further* that this Section 12.9 shall not apply to Claims for the breach of the representations or warranties in Section 9.2(a), (b), (c), (d), (e), (f), (g) and (j) or Section 12.1(iv) or to Claims for fraud, intentional misrepresentation, or intentional breach of the representations or warranties in Section 9.2. Neither Party shall have any liability to the other Party or its Representatives for Losses to the extent resulting from fraudulent actions or gross negligence of the other Party or its Representatives (or the University Responsible Parties in the case of the University). Notwithstanding anything herein to the contrary, the provisions of this University Lease do not waive or abrogate, nor are they intended to waive or abrogate, any limitation of liability for the University provided by Louisiana law, including without limitation under La. R.S. 13:5106.

Section 12.10. Other Matters.

- (a) *Waiver of Limits.* With respect to claims by UMLLC's employees, UMLLC waives its immunity, if any, to which it is entitled or would be entitled, as a complying employer under the applicable worker's compensation law, but only to the extent that such immunity would bar or affect recovery under or enforcement of UMLLC's obligations to defend, indemnify, hold harmless, or contribute to any sums due under any Losses.
- (b) *Losses Net of Insurance.* For purposes of this Article 12, the amount of any Losses for which payment is provided hereunder shall be net of any amounts recovered by the Obligee under insurance policies with respect to such Losses, it being understood that the obligations of the Obligee hereunder shall not be so reduced to the extent that any such recovery results in an increase in the Obligee's insurance premiums, or results in any other additional cost or expense to any such Obligee.

Section 12.11. Offset Rights; Limitations on Certain Damages.

- (a) Each Party's obligations under this University Lease are subject to, and each Party shall have the benefit of, all defenses, counterclaims, rights of offset or recoupment, or other claims and rights, including the right to deduct payments due to the other Party hereunder that are not subject to dispute (collectively, "Offsets"), which such Party may have at any time against such other Party (or any of their respective successors and assigns) or any transferee or assignee of any such other Party's rights as against such Party or any part thereof or interest therein contingent or otherwise, and no transfer or assignment of this University Lease or any other obligation of such other Party, or of any rights in respect thereof, pursuant to any plan of reorganization or liquidation or otherwise shall affect or impair the availability to each Party of the Offsets.
- (b) In no event shall any Party be liable to the other Party under this University Lease for consequential, indirect, exemplary or punitive damages (except for claims for fraud or for intentional misrepresentation or intentional breach).

Section 12.12. Governmental Immunity. Notwithstanding anything herein to the contrary, the Parties acknowledge and agree that the University and its officers, employees, and agents are relying on, and do not waive or intend to waive by any provision of this University Lease, the monetary limitations or any other rights, immunities, and protections provided by Law or otherwise available to the University and its officers, employees, and agents.

Section 12.13. Survival. This Article 12 shall remain in full force and effect in all circumstances and shall not be terminated by any breach (fundamental, negligent or otherwise) by any Party of its representations, warranties or covenants hereunder or by any termination or rescission of this University Lease by any Party.

ARTICLE 13 INSURANCE

Section 13.1. Insurance Coverage Required – UMLLC. UMLLC and any contractors or sub-contractors of UMLLC shall provide and maintain at UMLLC's own expense (without limitation of UMLLC's right to recover any Uncapped O&M Cost pursuant to clause (o) of the definition thereof), or cause to be maintained, during the Term and during any time period following expiration if UMLLC is required to return and perform any additional work, commercially reasonable insurance coverage in accordance with Prudent Industry Practices, including, at a minimum, the insurance coverages and requirements specified below, insuring the Utility System and all Utility System Operations (the "UMLLC Required Coverages"). For the avoidance of doubt, UMLLC Required Coverages may be provided and maintained as part of a corporate insurance program of a direct or indirect holder of equity in UMLLC and each of the insurance coverage limits set out in Section 13.1(b), Section 13.1(c), and Section 13.1(d) may be achieved through a combination of primary, excess, and/or umbrella coverage. Any coverage provided under a self-insured program *MUST* first be approved in writing by the University.

- (a) *Workers' Compensation and Employer's Liability.* UMLLC shall provide or cause to be provided statutory Workers' Compensation Insurance, to cover liability imposed by Federal and State statutes having jurisdiction over UMLLC's

employees engaged in the performance of this University Lease and Employer's Liability Insurance coverage with limits of not less than \$1,000,000 each employee disease, \$1,000,000 each accident, \$1,000,000 each disease policy limit.

- (b) *Commercial General Liability.* UMLLC shall provide or cause to be provided Commercial General Liability Insurance or equivalent with limits of not less than \$1,000,000 per occurrence and \$2,000,000 in the annual aggregate. Coverage shall include the following: bodily injury and property damage including personal injury, coverage for contractual employees (excluding any employees of the University), all premises and on going and completed operations, including blanket contractual and products/completed operations, explosion, collapse, mobile equipment not suitable for roadways, underground, separation of insureds, and liability assumed under an insured contract and shall be written on ISO form CG 00 01 12-07 or its equivalent.
- (c) *Commercial Automobile Liability.* When any motor vehicles (owned, non-owned or hired) are used in connection with work to be performed, UMLLC shall provide or cause to be provided Commercial Automobile Liability Insurance with limits of not less than \$1,000,000 combined single limit each accident for bodily injury and property damage. The policy shall be endorsed with CA 99 48 and MCS 90 (or their equivalents), if such exposure exists. The employee versus employee exclusion shall be removed.
- (d) *Umbrella Liability.* UMLLC shall provide or cause to be provided follow form Umbrella Liability Insurance with a minimum limit of \$50,000,000 per occurrence and shall apply in excess of the coverages for the UMLLC Required Coverages set forth in Section 13.1(a), Section 13.1(b) and Section 13.1(c)). In the event that such Umbrella Liability Insurance applies in excess of the coverages for UMLLC Required Coverage in Section 13.1(e), then the minimum limit for UMLLC Required Coverage in Section 13.1(e) shall be \$12,000,000 rather than \$15,000,00, and in the event that such Umbrella Liability Insurance applies in excess of the coverages for UMLLC Required Coverage in Section 13.1(g), then the minimum aggregate limit for UMLLC Required Coverage in Section 13.1(g) shall be \$10,000,000 rather than \$15,000,000.
- (e) *Professional Liability.* When any architects, engineers, construction managers, professional services providers or any other professional consultants perform work in connection with this University Lease, UMLLC shall maintain or require such architects, engineers, construction managers or other professional consultants to maintain Professional Liability Insurance, with limits not less than \$15,000,000 per claim and in the aggregate or such other limit (whether lower or higher) as the University and UMLLC may agree (each, acting reasonably) with respect to such policy for a particular Capital Improvement or Material Change, which other limit shall be included as part of the Approval of such Capital Improvement or Material Change in accordance with Section 4.3. The policy shall include: contingent bodily injury liability, rectification and punitive damages. The faulty workmanship exclusion should be modified to cover losses arising out of professional services.

Should UMLLC self-perform any work of the nature noted in this Section 13.1(e), evidence of Professional Liability Insurance meeting the standards for such work set forth above shall be required. Such insurance *shall remain* in place following completion of turnover date through the timing set forth in the applicable statute of repose.

- (f) *Network Security and Privacy Insurance.* UMLLC shall also maintain Cyber Liability Insurance for network security and privacy liability with limits of not less than \$10,000,000 per claim and in the aggregate inclusive of cybersecurity event management. Additionally coverage shall include: naming the University as Additional Insureds, \$10,000,000 per claim/aggregate Business Income/Network Interruption coverage, system failure cover, cyber extortion full limits, and physical damage ensuing from a cyber attack. When policies are renewed or replaced, the policy retroactive date shall coincide with, or precede, start of work in connection with this University Lease.
- (g) *Pollution Legal Liability.* UMLLC shall provide Pollution Legal Liability Insurance and Site Pollution Insurance (third party or first party) or cause to be provided Pollution Legal Liability Insurance or Site Pollution Insurance (third party or first party) or equivalent, in each case with limits of not less than \$10,000,000 per incident and \$15,000,000 in the aggregate during any 3 year period for environmental and pollution damage liability arising out of pollution events occurring after the Turnover Date.
- (h) *Property.* UMLLC shall obtain All Risk Property Insurance at full replacement cost, covering all loss, damage or destruction to the Utility System (including improvements and betterments and excluding any building in which the Shared Spaces are located), which insurance may be provided on a blanket basis with reported building values, which shall include the value of the coverage for the Utility System; provided, however, that the limits of such coverage may be based on replacement cost value agreed by the University and UMLLC acting reasonably or on a probable maximum loss analysis, subject to the University's approval of such probable maximum loss analysis by an independent third party that is reasonably acceptable to the University. Coverage shall include the following, but not be limited to: equipment breakdown, collapse, water including overflow, leakage, sewer backup or seepage, utility interruption, debris removal, business ordinance or law for increased cost of construction, extra expense, boiler and machinery, valuable papers and, to the extent commercially available, earthquake, flood, ground up terrorism (certified and non-certified) and named wind including storm surge. Coverage shall include flood insurance with a sublimit of not less than \$10,000,000 in the aggregate. The University and any Leasehold Mortgagee shall be named as Additional Insureds and as loss payees. UMLLC shall be responsible for any loss or damage to University property caused by UMLLC or its Representatives at full replacement cost, except to the extent such loss or damage is covered by the insurance described in Section 13.2(c), in which case UMLLC shall be responsible for the deductible only in accordance with Section 13.2(c) as well as any uninsured damages resulting from direct or indirect peril.

- (i) *All Risk Builder's Risk.* When UMLLC undertakes, pursuant to this University Lease, any construction, maintenance or repairs to the Utility System (including Capital Improvements, Material Changes and betterments), UMLLC shall provide or cause to be provided, All Risk Builder's Risk Insurance at replacement cost for materials, supplies, equipment, machinery and fixtures that are or will be part of the Utility System. Coverage shall include, but not be limited to, the following: right to partial occupancy, boiler and machinery, business income, valuable papers, ground up terrorism (including certified and non-certified incidents), and other consequential loss, when applicable with aggregate sublimits for catastrophic perils of earthquake, flood and named wind including storm surge which are the best available on commercially reasonable terms. The University and any Leasehold Mortgagee may be named as additional insured and as loss payees and included in any claim payment for signature prior to execution of the payment.
- (j) UMLLC's insurance, including Contractors and sub-contractors shall be primary and any insurance or self-insurance carried by the University shall not contribute with it. Any limits carried by UMLLC in excess of the required limits shown herein shall be available to the University.

Section 13.2. Insurance Coverage Required – University. The University shall provide and maintain at the University's own expense, or cause to be maintained, during the Term and during any time period following expiration if UMLLC is required to return and perform any additional work, the following insurance coverages and requirements specified below (the "University Required Coverages" together with the University Required Coverages, the "Required Coverages").

- (a) *Workers' Compensation.* The University shall provide or cause to be provided Workers' Compensation coverage, as prescribed by applicable Law, covering all University employees who agree to provide a service under this University Lease.
- (b) [*University Liability Coverage.* The University's liability coverage administered by the State's Office of Risk Management.]
- (c) *Property.* The University shall obtain All Risk Property Insurance at full replacement cost, covering all loss, damage or destruction to the University's owned property (other than any property leased to UMLLC hereunder), including improvements and betterments and the buildings in which the Shared Spaces are located, which insurance may be provided on a blanket basis with reported building values, which shall include the value of the coverage for the University's owned property required hereunder; provided, however, that the limits of such coverage may be based on replacement cost value. Coverage shall include the following: equipment breakdown, collapse, water including overflow, leakage, sewer backup or seepage, utility interruption, debris removal, business ordinance or law for increased cost of construction, extra expense, boiler and machinery, valuable papers and, to the extent commercially available, earthquake and named wind. Coverage shall include flood insurance with limits which are commercially available. UMLLC shall be responsible for the property deductible payable by the

University and/or the State of Louisiana for any loss or damage to University property caused by UMLLC or its Representatives.

Section 13.3. Additional Requirements.

- (a) *Evidence of Insurance.* The Parties shall deliver or cause to be delivered to each other's Representative designated in writing by each Party, original, latest edition standard ACORD form Certificates of Insurance, or equivalent documentation acceptable to the Parties, evidencing the UMLLC Required Coverages or University Required Coverages, as applicable, on or before the Turnover Date, and shall provide or cause to be provided, promptly following renewal and not more than 14 Business Days following renewal of the then current coverages (or such other period as is agreed to by the Parties), Renewal Certificates of Insurance, or such similar evidence, if such coverages have an expiration or renewal date occurring during the Term. The receipt of any certificate does not constitute agreement by the receiving party that the insurance requirements in this University Lease have been fully met or that the insurance policies indicated on the certificate are in compliance with all requirements of this University Lease. The failure of either Party to obtain certificates or other insurance evidence from the other Party shall not be deemed to be a waiver by such Party. Non-conforming insurance shall not relieve either Party of the obligation to provide insurance as specified herein.
- (b) *Notice of Cancellation or Violation.* Each carrier shall be required to notify the Certificate Holding, including the University, of notice of cancellation in accordance with policy provisions, and each Party to this contract shall notify the other Party in writing 30 Days (or in the case of cancellation for non-payment of premiums, 10 Days) prior to cancellation, non-renewal or any material change of any University Required Coverages (in the case of the University) or UMLLC Required Coverages (in the case of UMLLC). Without limiting Section 13.3(e), the University shall be permitted (but not obligated) to pay any delinquent premiums before the cancellation date specified by the insurer in any notice of cancellation for non-payment of premium in order to maintain such coverage in full force and effect and UMLLC shall reimburse the University for any delinquent premiums paid by the University on demand without any Days of grace and without prejudice to any other rights and remedies of the Parties hereunder.
- (c) *Deductibles.* All deductibles or self-insured retentions for UMLLC Required Coverages or UMLLC Contractors in excess of \$200,000 (Adjusted for Inflation annually) shall not exceed amounts approved by the University in writing. Except as expressly provided herein, any and all deductibles or self-insured retentions on Required Coverages shall be borne by the purchasing Party or its Contractors, who shall be responsible for its own deductibles and/or self-insured retentions unless the Party is at fault for a loss to the other Party in which case the at fault party will pay the other Party's deductible or self-retention.
- (d) *Waiver of Subrogation.* Each of the Required Coverages provided by UMLLC pursuant to this University Lease (other than those set forth in Section 13.2(a) and

Section 13.2(b)) shall, where legally or customarily permitted, include a waiver by the insurer of its rights of subrogation against the other, its employees, elected officials, agents or Representatives (and, in the case of the UMLLC Required Coverages, against the State of Louisiana; the University, their agents, officials, and employees. UMLLC shall cause each of its Contractors and subcontractors to waive all their rights of subrogation against the State of Louisiana; the University, their agents, officials, and employees.

- (e) *University's Right to Insure.* Without limiting Section 13.3(b), if UMLLC fails to obtain and maintain or cause to be obtained and maintained UMLLC Required Coverage in accordance with this Article 13, the University shall have the right (without any obligation to do so), upon 2 Business Days' notice to UMLLC in a non-emergency situation or forthwith in an emergency situation and without assuming any obligation in connection therewith, to effect such insurance and all costs and expenses in connection therewith shall be payable by UMLLC on demand without any Days of grace and without prejudice to any other rights and remedies of the University hereunder. Such insurance taken out by the University shall not relieve UMLLC of its obligations to insure hereunder and the University shall not be liable for any loss or damage suffered by UMLLC in connection therewith.
- (f) *No Limitation as to UMLLC Liabilities.* UMLLC expressly understands and agrees that any coverages and limits furnished by UMLLC shall in no way limit UMLLC's liabilities and responsibilities specified within this University Lease or by Law.
- (g) *No Contribution by the University.* UMLLC expressly understands and agrees that any insurance or self-insurance programs maintained by the University or the State of Louisiana shall not contribute with insurance provided by UMLLC under this University Lease.
- (h) *Insurance Requirements of Contractors.* UMLLC shall require in each contract with any Contractor that such Contractor obtain coverages reasonably comparable to the UMLLC Required Coverages that are reasonably appropriate in their limits and other terms and conditions, in each case to the nature of the contract with the Contractor. Such coverages shall insure the interests of the State of Louisiana, the University, their agents, officials, and employees (provided that such agents, officials or employees shall not be included if not permitted by applicable Law or commercially available), UMLLC and any other Contractors in respect of the applicable work being performed and shall be subject to the same (or comparable) coverage and administrative requirements as are imposed on UMLLC pursuant to this University Lease, specifically requiring such Contractor to name the State of Louisiana, the University, their agents, officials and employees as Additional Insureds and requiring such Contractor's insurance to include a waiver of subrogation as described in Section 13.3(d). When requested to do so by the University, UMLLC shall provide, or cause to be provided, to the University Certificates of Insurance with respect to such insurance coverages or such other evidence of insurance, as may be reasonably acceptable in form and content to the University.

- (i) *Cooperation.* The University and UMLLC shall do all acts, matters and things as may be reasonably necessary or required to expedite the adjustment of any loss or damage covered by insurance hereunder so as to expedite the release and dedication of proceeds of such insurance in the manner and for the purposes herein contemplated.
- (j) *Joint Venture and Limited Liability Company Policies.* If UMLLC or any Contractor required to obtain an insurance policy hereunder is a joint venture or limited liability company, all insurance policies required to be obtained by UMLLC or such Contractor shall specifically name the joint venture or limited liability company as a named insured. If UMLLC contracts operations to a third party, UMLLC will be an additional insured on any liability policy.
- (k) *Other Insurance Obtained by UMLLC.* If UMLLC or its Contractors desire coverages in addition to the UMLLC Required Coverages, UMLLC and each Contractor shall be responsible for the acquisition and cost of such additional coverages. If UMLLC or its Contractors obtain any property, liability or other insurance coverages that will relate to the Utility System or the Utility System Operations in addition to the UMLLC Required Coverages (“Additional Coverages”), then UMLLC or its Contractors shall (i) notify the University as to such Additional Coverages at least 10 Business Days in advance of purchasing such Additional Coverages and make such modifications as the University may reasonably require so that such Additional Coverage does not conflict with the University’s insurance coverages, (ii) provide the University with any documentation relating to the Additional Coverages, including Certificates of Insurance, that the University reasonably requests and (iii) at the University’s election, acting reasonably, cause the State of Louisiana, the University, their agents, officials and employees, to be named as additional insureds under such Additional Coverages, if that is normally allowed in accordance with good industry practice.
- (l) *University’s Right to Modify.* The University shall have the right, acting reasonably, to request to modify, delete, alter or change insurance coverage requirements set forth in Section 13.1 and this Section 13.3. Notwithstanding anything to the contrary herein, (i) any change to the types or limits of contractually required insurance coverage shall be subject to mutual agreement of the Parties, each acting reasonably, and (ii) if any insurance (including the limits or deductibles thereof) required to be maintained under this University Lease shall not be available at commercially reasonable rates, UMLLC’s obligation to obtain or maintain such insurance shall be waived by the University for as long as such insurance shall not be available at commercially reasonable rates, provided that during the period of such waiver, UMLLC maintains the maximum amount of such insurance otherwise available at commercially reasonable rates.
- (m) *Commercial Availability.* To the extent any of the Required Coverages are not available on a commercially reasonable basis or on commercially reasonable terms, the Party responsible for obtaining such Required Coverage shall obtain insurance

that is available on a commercially reasonable basis or on commercially reasonable terms that best approximates the applicable Required Coverages, but said substitute coverage shall, at the other Party's request, be subject to review of an independent insurance consultant, and such independent insurance consultant shall have delivered to the University and UMLLC its opinion to the effect that the substitute coverages meet the above-stated criteria.

- (n) *Endorsements.* All UMLLC Required Coverages (except for the professional liability, workers' compensation and employer's liability policies) shall be endorsed to include the State of Louisiana, the University, their agents, officials, and employees as Additional Insureds, in each case to the extent permitted by Law and commercially available. For the avoidance of doubt, Blanket Additional Insured endorsements that provide coverage "where required by contract" shall be acceptable for this purpose. The General Liability Additional Insured provisions will include both on-going and completed operations and confirmed accordingly in the Certificates of Insurance.
- (o) *UMLLC Required Coverage Requirements.* All UMLLC Required Coverages and UMLLC's All Risk Property Insurance described in Section 13.2(c) shall be issued by reputable insurance companies duly authorized to engage in the insurance business in the State of Louisiana, with an A.M. Best's rating of A-, VII or better, be primary noncontributory coverage and contain severability of interests provisions.
- (p) *Defense of Coverage Outside Limits of Liability.* All UMLLC Required Coverages shall include defense coverage outside the limits of liability, except for the Professional Liability Insurance required to be carried by UMLLC.
- (q) *Requirements for UMLLC Required Coverages for Liability Policies.* All UMLLC Required Coverages that are liability policies shall be occurrence-based, except where not commercially available, in which case they shall be on a claims-made basis, provided that such policies shall extend for a period of 5 years after the expiration or earlier termination of this University Lease, which obligation shall survive the expiration or earlier termination of this University Lease.
- (r) *Payment for Insurance Coverage.* To the extent that the University and UMLLC determine that it would be in the best interests of both Parties for any of the UMLLC Required Coverages to be purchased by and held in the name of the University, then the University shall be responsible for purchasing those certain UMLLC Required Coverages, which shall satisfy UMLLC's obligation to do so hereunder. The University shall name UMLLC and the Leasehold Mortgagee as additional insureds thereunder.

Section 13.4. Damage and Destruction.

- (a) *Obligations of UMLLC.* If all or any part of any of the Utility System shall be destroyed or damaged during the Term in whole or in part by fire or other casualty

of any kind or nature (including any casualty for which insurance was not obtained or obtainable), ordinary or extraordinary, foreseen or unforeseen, UMLLC shall:

- (i) give the University notice thereof promptly after UMLLC receives actual notice of such casualty;
- (ii) at its sole cost and expense, whether or not insurance proceeds, if any, shall be equal to the estimated cost of repairs, alterations, restorations, replacement and rebuilding (the “Casualty Cost”), which for the avoidance of doubt shall not be included in the Utility Fee, proceed diligently to repair, restore or rebuild the same to the condition existing prior to the happening of such fire or other casualty or with such modifications, including as to location or configuration, as directed by the University provided such modifications shall not materially and adversely affect UMLLC’s ability to perform the Utility System Operations once completed and such cost shall be included in the Casualty Costs (any such activity being a “Restoration”); and
- (iii) if the Casualty Cost cumulatively exceeds \$1,000,000, deposit all insurance proceeds received by UMLLC in connection with the relevant Restoration with the Depositary selected by the University pursuant to Section 13.4(b); provided, however, that if at any time the Casualty Cost exceeds the net insurance proceeds then deposited with the Depositary, then UMLLC shall also deposit with the Depositary such cash as is sufficient to cover the difference between the Casualty Cost and the net insurance proceeds deposited pursuant to this Section 13.4(a)(iii) and Section 13.4(b) (the “Restoration Shortfall Amount”), except to the extent such difference is caused by the negligence or willful misconduct of, or violation of applicable Law by, the University or is the result of any modifications made by the University pursuant to Section 13.4(a)(ii) in which case the University shall be responsible to make such deposit (collectively, with (A) any insurance proceeds received by UMLLC with respect to such Casualty not on deposit with the Depositary and (B) any interest earned on all such funds, the “Restoration Funds”).

Any Restoration undertaken pursuant to this Section 13.4 shall be undertaken in accordance with and subject to the terms of this University Lease. Prior to the commencement of Restoration work, UMLLC shall submit to the University for Approval by the University the plans for the Restoration work and such work shall not be undertaken unless the plans for such work have been Approved by the University in writing. For the avoidance of doubt, and notwithstanding any direction by the University to modify the location or configuration of the Utility System pursuant to Section 13.4(a)(ii), the Restoration Shortfall Amount shall not be considered a New Approved Capital Improvement Cost.

- (b) *Rights of the University.* If (i) UMLLC shall fail or neglect to commence the diligent Restoration of the Utility System or the portion thereof so damaged or

destroyed, (ii) having so commenced such Restoration, UMLLC shall fail to diligently complete the same in accordance with the terms of this University Lease or (iii) prior to the completion of any such Restoration by UMLLC, this University Lease shall expire or be terminated in accordance with the terms of this University Lease, the University may, but shall not be required to, complete such Restoration at UMLLC's expense and shall be entitled to be paid out of the Restoration Funds, but such payment shall not limit UMLLC's obligation to pay the University's reasonable Restoration expenses, less amounts received by the University from such Restoration Funds. In any case where this University Lease shall expire or be terminated prior to the completion of the Restoration, UMLLC shall (x) account to the University for all amounts spent in connection with any Restoration which was undertaken, (y) pay over or cause the Depository to pay over to the University within 30 Days after demand therefor, the remainder, if any, of the Restoration Funds received by UMLLC prior to such termination or cancellation and (z) pay over or cause the Depository to pay over to the University, for allocation to the University, within 30 Days after receipt thereof, any Restoration Funds received by UMLLC or the Depository subsequent to such termination or cancellation. The UMLLC's obligations under this Section 13.4(b) shall survive the expiration or termination of this University Lease.

(c) *Payment of Restoration Funds to UMLLC.* Subject to the satisfaction by UMLLC of all of the terms and conditions of this Section 13.4, the Depository shall pay to UMLLC from time to time, any Restoration Funds then held by the Depository, but not more than the amount actually collected by the Depository upon the loss, together with any interest earned thereon, after reimbursing itself therefrom, as well as the University, to the extent, if any, of the reasonable expenses paid or incurred by the Depository and the University in the collection of such monies, to be utilized by UMLLC solely for the Restoration, such payments to be made as follows:

- (i) prior to commencing any Restoration, UMLLC shall furnish the University with an estimate of the cost of such Restoration, prepared by an architect or engineer;
- (ii) the Restoration Funds then held by the Depository shall be paid to UMLLC in installments as the Restoration progresses, subject to Section 13.4(c)(iii), based upon requisitions to be submitted by UMLLC to the Depository and the University in compliance with Section 13.4(d), showing the cost of labor and materials purchased for incorporation in the Restoration, or incorporated therein since the previous requisition, and due and payable or paid by UMLLC; provided, however, that if any lien (other than a Permitted UMLLC Encumbrance) is filed against the Utility System or any part thereof in connection with the Restoration, UMLLC shall not be entitled to receive any further installment until such lien is satisfied or discharged (by bonding or otherwise); provided further that notwithstanding the foregoing, but subject to the provisions of Section 13.4(c)(iii), the existence of any such lien shall not preclude UMLLC from receiving any installment of Restoration Funds so long as such lien will be discharged with funds from

such installment and at the time UMLLC receives such installment UMLLC delivers to the University and the Depositary a release of such lien executed by the lienholder or and in recordable form;

- (iii) the amount of any installment to be paid to UMLLC shall be the amount of Restoration Funds incurred by UMLLC in connection therewith, less 10% of such amount as a retainage (which 10% retainage shall (i) be reserved without duplication of any retainage reserved by UMLLC under its contracts for the Restoration work and (ii) shall be released to UMLLC upon completion of the Restoration work), except that such retainage shall not include any amounts for architects' or engineers' fees or permitting or other governmental fees in connection with the Restoration or with respect to each Contractor upon the final completion of each such Contractor's respective work, provided that the unapplied portion of the funds held by the Depositary are sufficient to complete the Restoration; provided, however, that all disbursements to UMLLC shall be made based upon an architect's or engineer's certificate for payment in accordance with industry standards, and disbursements may be made for advance deposits for materials and Contractors to the extent that such disbursements are customary in the industry and provided that the unapplied portion of the funds held by the Depositary are sufficient to complete the Restoration; and
- (iv) except as provided in Section 13.4(b) and subject to Section 13.4(h), upon completion of and payment for the Restoration by UMLLC, the Depositary shall pay the balance of the Restoration Funds, if any, to UMLLC; provided, however, that if the insurance proceeds are insufficient to pay for the Restoration (or if there shall be no insurance proceeds), UMLLC shall nevertheless be required to make the Restoration, provided the deficiency in funds necessary to complete the Restoration is provided in accordance with Section 13.4(a)(iii).

For the avoidance of doubt, the costs incurred for Capital Improvements made as part of the Restoration shall not be considered Capital Improvement Costs for purposes of Schedule 5 or otherwise included in the calculation of the Utility Fee.

- (d) *Conditions of Payment.* The following shall be conditions precedent to each payment made to UMLLC as provided in Section 13.4(c):
 - (i) at the time of making such payment, no UMLLC Default exists, except if such UMLLC Default is the result of the damage or destruction for which such payment is being made;
 - (ii) the Restoration shall be carried out under the supervision of the architect or engineer, and there shall be submitted to the Depositary and the University the certificate of the architect or engineer (or other evidence reasonably satisfactory to the University) stating that (A) the materials and other items which are the subject of the requisition have been delivered to the Utility

System (except with respect to requisitions for advance deposits permitted under Section 13.4(c)(iii)), free and clear of all Encumbrances, and no unsatisfied or unbonded mechanic's liens or other Encumbrances have been claimed, except for any mechanic's lien for claims that will be discharged, by bonding or otherwise, with funds to be received pursuant to such requisition (provided that a release of such lien is delivered to the Depository in accordance with Section 13.4(c)(ii)), or insured over by title insurance reasonably acceptable to the University, (B) the sum then requested to be withdrawn either has been paid by UMLLC or is due and payable to Contractors, engineers, architects or other Persons (whose names and addresses shall be stated), who have rendered or furnished services or materials for the work and giving a brief description of such services and materials and the principal subdivisions or categories thereof and the several amounts so paid or due to each of such Persons in respect thereof, and stating in reasonable detail the progress of the work up to the date of such certificate, (C) no part of such expenditures has been made the basis, in any previous requisition (whether paid or pending), for the withdrawal of Restoration Funds or has been made out of the Restoration Funds received by UMLLC, (D) the sum then requested does not exceed the value of the services and materials described in the certificate, (E) the work relating to such requisition has been performed in accordance with this University Lease, (F) the balance of the Restoration Funds held by the Depository will be sufficient upon completion of the Restoration to pay for the same in full, and stating in reasonable detail an estimate of the cost of such completion and (G) in the case of the final payment to UMLLC, the Restoration has been completed in accordance with this University Lease.

- (e) *Payment and Performance Bonds.* If UMLLC obtains payment or performance bonds related to a Restoration (which UMLLC may or may not obtain in its discretion), UMLLC shall name the State of Louisiana, the University, their agents, officials, and employees, UMLLC and the Leasehold Mortgagee, as their interests may appear as additional obligees, and shall deliver copies of any such bonds to the University promptly upon obtaining them. The claims of any such additional obligee with respect to such payment of performance bonds shall rank *pari passu* in priority with the claims of all other additional obligees.
- (f) *Benefit of the University.* The requirements of this Section 13.4 are for the benefit only of the University, and no Contractor or other Person shall have or acquire any claim against the University as a result of any failure of the University actually to undertake or complete any Restoration as provided in this Section 13.4 or to obtain the evidence, certifications and other documentation provided for herein.
- (g) *Investment of Restoration Funds.* Restoration Funds deposited with a Depository shall be invested and reinvested in Eligible Investments at the direction of UMLLC, and all interest earned on such investments shall be added to the Restoration Funds.

- (h) *Lien of Leasehold Mortgage.* Any Restoration Funds not used for the Restoration shall be subject to the lien of the applicable Leasehold Mortgage, but only after such Restoration is complete.
- (i) *Personal Property.* UMLLC shall be responsible for all loss or damage to personal property (including materials, fixtures/contents, equipment, tools and supplies) of UMLLC unless caused by the University.

Section 13.5. Additional UMLLC Requirements.

- (a) UMLLC shall submit, at UMLLC's cost and expense, all design documents for proposed Capital Improvements to the Utility System to the standard University design and construction review process, including, but not limited to submitting documents to the University's Facilities and Property Oversight Department, c/o the Associate Vice President, Facility & Property Oversight, and the University's property insurance carrier for a plan review.
- (b) UMLLC shall cooperate and participate, at UMLLC's cost and expense, in any and all Utility System Land visits or site inspections by or for any University insurance carrier.

**ARTICLE 14
ADVERSE ACTIONS**

Section 14.1. Adverse Action.

- (a) An "Adverse Action" shall occur if the City-Parish, the State of Louisiana, or any agency, political division, or unit or commission thereof, or the University, at any time during the Term, takes any action or actions and the effect of such action or actions, individually or in the aggregate, is reasonably expected (x) to be principally borne by UMLLC or by private sector utility concessionaires at universities and other public institutions in Louisiana, including UMLLC, and, in either case, not by other Persons and (y) to have a material adverse effect on the fair market value of the UMLLC Interest (whether as a result of a decrease in the Utility Fee or other revenues, increased expenses that cannot be recovered pursuant to this University Lease, or both), except where such action is in response to any act or omission on the part of UMLLC that is illegal (other than an act or omission rendered illegal by virtue of the Adverse Action) or such action is otherwise permitted under this University Lease; *provided, however*, that none of the following shall be an Adverse Action: (A) the development, redevelopment, construction, modification, or change in the operation of any existing or new utility facility (other than any Utility Facility) or utility (including a new source of energy or power) (other than the Utilities) whether or not it results in the reduction of the Variable Fee Component over time; (B) the imposition of a state or local Tax of general application or federal Tax or an increase in state or local Taxes of general application or federal Taxes; or (C) any action of the Louisiana Public Service Commission or the Federal Energy Regulatory Commission, or their respective

successors, that subjects UMLLC to such agency's regulatory jurisdiction due solely to the Utility System Operations performed by UMLLC in accordance with this University Lease.

- (b) If an Adverse Action occurs, UMLLC may elect, subject to Section 14.2 and Section 14.3, to either (i) be paid by the University the Concession Compensation with respect thereto (such Concession Compensation, the "AA-Compensation") or (ii) terminate this University Lease and be paid by the University the Termination Damages, in either case by giving notice in the manner described in Section 14.1(c).
- (c) If an Adverse Action occurs, UMLLC shall give written notice (the "AA-Preliminary Notice") to the University within thirty (30) Days following the date on which UMLLC first became aware of the Adverse Action stating that an Adverse Action has occurred. Within one hundred eighty (180) Days following the date of delivery of the AA-Preliminary Notice, UMLLC shall give the University another notice (the "AA-Notice") setting forth (i) the details of the effect of the occurrence that is principally borne by UMLLC, (ii) details of the material adverse effect of the said occurrence on the fair market value of the UMLLC Interest, (iii) a statement as to which right in Section 14.1(b) UMLLC elects to exercise, and (iv) if UMLLC elects to exercise the right to AA-Compensation under Section 14.1(b), the amount claimed as AA-Compensation and details of the calculation thereof. The University shall, after receipt of the AA-Notice, be entitled by notice delivered to UMLLC no later than thirty (30) Days following the date of receipt of the AA-Notice, to require UMLLC to provide such further supporting particulars as the University may reasonably consider necessary. If the University wishes to dispute the occurrence of an Adverse Action or the amount of AA-Compensation, if any, claimed in the AA-Notice, the University shall give written notice of dispute (the "AA-Dispute Notice") to UMLLC within thirty (30) Days following the date of receipt of the AA-Notice stating in reasonable detail the grounds for such dispute. If neither the AA-Notice nor the AA-Dispute Notice has been withdrawn within thirty (30) Days following the date of receipt of the AA-Dispute Notice by UMLLC, the matter shall be submitted to the dispute resolution procedure in Article 18.
- (d) If UMLLC has elected to exercise its right to AA-Compensation pursuant to Section 14.1(b), the University shall pay such AA-Compensation as Concession Compensation in accordance with Article 15.
- (e) Payment of the entire sum of the Termination Damages or the AA-Compensation, as the case may be, by the University to UMLLC, shall constitute full and final satisfaction of all amounts that may be claimed by UMLLC for and in respect of the occurrence of an Adverse Action, as the case may be, and, upon such payment, the University shall be released and forever discharged by UMLLC from any and all liability in respect of such Adverse Action, except if UMLLC elects to be paid AA-Compensation and the effect of the applicable Adverse Action continues to be borne after the Compensation Calculation Measuring Period in which it took place, in which case, UMLLC may make a claim for AA-Compensation in subsequent Compensation Calculation Measuring Periods to the extent UMLLC is affected by

such Adverse Action in such Compensation Calculation Measuring Period, but UMLLC may not change its election to receive AA-Compensation with respect to such Adverse Action.

Section 14.2. Termination.

- (a) If UMLLC has elected to exercise its right to terminate this University Lease in connection with an Adverse Action pursuant to Section 14.1(b), then this University Lease, subject to Section 14.3, shall terminate sixty (60) Days following the date of receipt of the AA-Notice by the University, and the University shall pay an amount equal to the aggregate of (i) the Utility System Concession Value as of the date of such termination (which shall be determined as if no Adverse Action has occurred, plus) (ii) without duplication, the unpaid Concession and KPI Compensation Balance (for the avoidance of doubt, including any Unrecovered Balances), plus (iii) without duplication, the out-of-pocket and documented costs and expenses incurred by UMLLC (which costs and expenses shall include reasonable payments due and payable by UMLLC or the Concessionaire to the Operator or other Contractors pursuant to an Operating Agreement or similar agreement) or the Operator as a result of such termination, plus (iv) the Concession Compensation calculated for the period between the date of the Adverse Action and the date of termination less (v) any insurance or condemnation proceeds received by UMLLC in respect of all or any portion of the Utility System as a result of such Adverse Action (collectively, the “Termination Damages”), together with any Taxes payable by UMLLC on the gross amount of such Termination Damages, to UMLLC on the Reversion Date or, if the Termination Damages are determined on a date subsequent to the Reversion Date, then not later than sixty (60) Days following the date of determination of the Termination Damages; *provided* that, subject to the right of UMLLC to receive interest at the Bank Rate on the payment owed by the University from the date of receipt of the AA-Dispute Notice to the date on which payment is made, the University may defer any such payment for an additional one hundred twenty (120) Days in the University’s discretion; *provided, however*, that any amounts received by UMLLC or any Leasehold Mortgagee from any insurance policies payable as a result of damage or destruction to the Utility System that has not been remedied prior to the Reversion Date, shall, to the extent not used to remedy such effects, be deducted from the amount payable by the University to UMLLC, so long as the University has not received any such amounts pursuant to Section 13.4.
- (b) Any dispute arising out of the determination of the Termination Damages shall be submitted to the dispute resolution procedure in Article 18.
- (c) This University Lease shall not terminate pursuant to Section 14.2(a) unless UMLLC has first obtained and delivered to the University the written consent of the Leasehold Mortgagee to such termination.

Section 14.3. Right of the University to Remedy. If the University wishes to remedy the occurrence of an Adverse Action (other than an Adverse Action by the University that

constitutes a breach of this University Lease, to which this Section 14.3 shall have no application without the written consent of UMLLC), including by reimbursing UMLLC such funds as are necessary to compensate UMLLC for the material adverse economic effect on UMLLC of such Adverse Action, the University shall give written notice thereof to UMLLC within thirty (30) Days following the date of receipt of the AA-Notice. If the University gives such notice it must remedy the applicable Adverse Action within one hundred twenty (120) Days following the date of receipt of the AA-Notice or, if a AA-Dispute Notice has been given, within one hundred twenty (120) Days following the final determination pursuant to Article 18 that an Adverse Action occurred; *provided, however*, that in the event of a remedy involving payment of funds to UMLLC, the University shall be deemed to have remedied the applicable Adverse Action as of the date that the University provides a written commitment to UMLLC to pay such funds from time to time as are necessary to compensate UMLLC as it is financially adversely affected by the applicable Adverse Action from time to time. If the University elects to remedy the occurrence of an Adverse Action within the applicable period of time, the right of UMLLC shall be limited to a claim for AA-Compensation with respect to such Adverse Action.

Section 14.4. Other Actions by Governmental Authorities. In the event that any Governmental Authority proposes to take any action at any time during the Term (including enacting any Law) and the effect of such action is reasonably expected (i) to be principally borne by UMLLC or by private sector utility concessionaires at universities and other public institutions in Louisiana, including UMLLC (and not by others) and (ii) to have a Material Adverse Effect, except where such action is in response to any act or omission on the part of UMLLC that is illegal (other than an act or omission rendered illegal by virtue of an Adverse Action or such action by any such Governmental Authority), then at the request of UMLLC, the University shall use its reasonable efforts to oppose and challenge such action by any such Governmental Authority; *provided, however*, that all reasonable out-of-pocket costs and expenses incurred by the University in connection with such opposition or challenge shall be borne by UMLLC.

Section 14.5. Regulatory Filings. The Parties acknowledge and agree that they share a common interest in any regulatory proceedings that involve the Utility System Operations. Consistent therewith, the Parties agree that, to the extent that UMLLC or the University is required to make any regulatory filing or submission with respect to a tariff or rate for the Utility System or the Utility Fee, UMLLC and the University shall reasonably cooperate in connection with such required filing or submission and shall, collectively, only make one filing or submission with the applicable regulatory agency. Such cooperation shall include appearing at, and participating in, any regulatory proceeding at the request of the other Party. UMLLC and the University shall also reasonably cooperate with respect to any required regulatory filings or submissions not involving a tariff or rate for the Utility System or the Utility Fee, to the extent practicable.

ARTICLE 15

DELAY EVENTS; CONCESSION COMPENSATION AND KPI COMPENSATION

Section 15.1. Delay Events.

- (a) If UMLLC is affected by a Delay Event, it shall give written notice as soon as practicable but in no event later than ten (10) Business Days following the date on which it first became aware of the effect of such Delay Event on UMLLC (provided

that in the case of such Delay Event being a continuing cause of delay, only one notice shall be necessary), which notice shall include (i) a statement of which Delay Event the claim is based upon, (ii) details of the circumstances from which the delay arises, and (iii) an estimate of the delay in the performance of obligations under this University Lease attributable to such Delay Event and information in support thereof, if known at that time. The University shall, after receipt of any such notice, be entitled by notice to require UMLLC to provide such further supporting particulars as the University may reasonably consider necessary.

- (b) UMLLC shall notify the University within five (5) Business Days following the date on which it first became aware that a Delay Event has ceased.
- (c) Subject to UMLLC giving the notice required in Section 15.1(a), a Delay Event shall excuse UMLLC from whatever performance is prevented by the Delay Event referred to in such notice and, to the extent applicable, for such appropriate number of Days as the University and UMLLC jointly determine, each acting reasonably. If the University and UMLLC cannot agree upon the period of extension, then either Party shall be entitled to refer the matter to the dispute resolution procedure in Article 18. This Section 15.1(c) shall not excuse UMLLC from the performance and observance under this University Lease of all obligations and covenants not affected by the Delay Event. While a Delay Event is occurring, the Utility Fee shall be reduced by an amount equal to the Utility Fee multiplied by the percentage of the Utility System that is inoperable as a result of the Delay Event, as determined by the University in its reasonable discretion (as determined by the reduction in delivery capacity as compared to the delivery capacity immediately preceding such Delay Event), provided that such Delay Event shall be deemed a Compensation Event. Notwithstanding the occurrence of a Delay Event, UMLLC shall continue its performance and observance under this University Lease of all of its obligations and covenants to the extent that it is reasonably able to do so and shall use its commercially reasonable efforts to minimize the effect and duration of the Delay Event. Nothing herein shall permit or excuse noncompliance with a change to applicable Laws.
- (d) Except as provided in the immediately following sentence, (i) if a Delay Event occurs that has the effect of causing physical damage or destruction to a material part of the Utility System that results in the Utility System being substantially unavailable to UMLLC, the Concessionaire or the Operator for the performance of obligations under this University Lease and such effect continues for a period in excess of one hundred twenty (120) continuous Days or one hundred twenty (120) non-continuous Days within a three hundred sixty (360) -Day period and has a Material Adverse Effect, for which UMLLC is not made whole through Concession Compensation, or (ii) if insurance policies payable (or that should have been payable but for the breach of an obligation to take out and maintain such insurance policy by UMLLC), condemnation or other similar proceeds are insufficient to restore UMLLC to the same economic position as it would have been in the absence of such event and UMLLC is not otherwise made whole through Concession Compensation, then, notwithstanding Section 2.1, in either case, UMLLC shall

have the right, but not the obligation, by written notice to the University within thirty (30) Days after the Delay Event Remedy is permitted to be elected, to extend the Term for a period that would be sufficient to compensate UMLLC and restore it to the same economic position as it would have been in had such Delay Event not occurred (a “Delay Event Remedy”); *provided, however*, in no event shall the Term be extended if such extension is prohibited by Law or if the extended Term, when taking into account such extension, would subject UMLLC or the University to a leasehold tax, conveyance fee or similar charge under applicable Law. If UMLLC timely elects to exercise the right to the Delay Event Remedy but such exercise is prohibited by Law or would subject UMLLC or the University to a leasehold tax, conveyance fee or similar charge under applicable Law, (i) the Delay Event Remedy shall be modified such that the Term is extended only for such period as would not cause exercise of the Delay Event Remedy to be prohibited by Law or to subject UMLLC or the University to a leasehold tax, conveyance fee or similar charge under applicable Law, and (ii) the relevant Delay Event shall be a Compensation Event to the extent necessary to compensate UMLLC and restore it to the same economic position as it would have been in, absent the modification to the Delay Event Remedy pursuant to clause (i) of this sentence.

- (e) If UMLLC elects to exercise the right to the Delay Event Remedy, within five (5) Business Days following the date on which UMLLC first became aware of its right to the Delay Event Remedy pursuant to Section 15.1(d)(i) or Section 15.1(d)(ii), UMLLC shall give written notice (a “Delay Event Remedy Notice”) to the University setting forth (i) the details of the relevant Delay Event and its effect on either causing physical damage or destruction to the Utility System that results in the Utility System being substantially unavailable for the provision of Utility Services, (ii) the amount claimed to be required to restore UMLLC to the same economic position as it would have been in had such Delay Event not occurred (including the details of the calculation thereof), and (iii) the details of the relationship between such amount and UMLLC’s proposed extension of the Term. The University shall, after receipt of the Delay Event Remedy Notice, be entitled by notice to require UMLLC to provide such further supporting particulars as the University may reasonably consider necessary. If the University wishes to dispute the occurrence of a Delay Event or the Delay Event Remedy claimed in the Delay Event Remedy Notice, the University shall give written notice to dispute (the “Delay Event Remedy Dispute Notice”) to UMLLC within thirty (30) Days following the date of receipt of the Delay Event Remedy Notice stating the grounds for such dispute, and if neither the Delay Event Remedy Notice nor the Delay Event Remedy Dispute Notice has been withdrawn within thirty (30) Days following the date of receipt of the Delay Event Remedy Dispute Notice by UMLLC, the matter shall be submitted to the dispute resolution procedure in Article 18. For the avoidance of doubt, if the conditions set forth in Section 15.1(d)(i) and Section 15.1(d)(ii) occur with respect to the same Delay Event, UMLLC may have two (2) opportunities to provide a Delay Event Remedy Notice.

Section 15.2. Notice of Compensation Events and KPI Events. Except as provided elsewhere in this University Lease, if a Compensation Event occurs, UMLLC shall give written

notice to the University within forty-five (45) Days following the date on which UMLLC first became aware of the Compensation Event stating that a Compensation Event has occurred. Except as provided elsewhere in this University Lease, if a KPI Event occurs, the University shall give written notice to UMLLC within forty-five (45) Days following the date on which the University first became aware of the KPI Event stating that a KPI Event has occurred.

Section 15.3. Payments of Concession Compensation and KPI Compensation.

- (a) Within fourteen (14) Days after each Compensation Calculation Date, UMLLC shall send the University notice setting forth all Concession Compensation due for the immediately preceding Compensation Calculation Measuring Period, and the University shall send UMLLC notice setting forth all KPI Compensation due for the immediately preceding Compensation Calculation Measuring Period. Each such notice shall set forth: (i) the amount claimed and details of the calculation thereof; (ii) details of the Compensation Event(s), Adverse Action(s), and KPI Event(s), as applicable, as a result of which Concession Compensation and KPI Compensation, as applicable, is claimed therein, including an explanation of the reasons that such event(s) constitute Compensation Event(s), Adverse Action(s) and KPI Event(s), as applicable, under the terms of this University Lease; and (iii) the amount claimed as Concession Compensation and KPI Compensation, as applicable, with respect to each such Compensation Event, Adverse Action and KPI Event, as applicable, and details of the calculation thereof.
- (b) If either Party wishes to dispute the occurrence of any Compensation Event(s), Adverse Action(s), or KPI Event(s) set forth in the notices described in Section 15.3(a) or the amounts claimed thereunder, then such Party shall give written notice of dispute (the “Dispute Notice”) to the other Party within thirty (30) Days following the date of receipt of the relevant notice stating the grounds for such dispute. If the Dispute Notice has not been withdrawn or the dispute otherwise resolved by the Parties within thirty (30) Days following the date of receipt of the Dispute Notice, the matter shall be submitted to the dispute resolution procedure set forth in Article 18.
- (c) The University and UMLLC shall cooperate and assist in good faith in the determination of the Concession Compensation and KPI Compensation in accordance with this Section 15.3, including making available, to the extent reasonably necessary, books, records, work papers and personnel at such reasonable times as any Party shall request and permitting (at the expense of the requesting Party) the copying of any records or extracts thereof reasonably requested, subject to Section 3.12.
- (d) The University shall have the right, prior to any payment of the Concession and KPI Compensation Balance, to include any Concession Compensation in the applicable Utility Fee as (i) a New Approved Capital Improvement if the Concession Compensation was incurred in connection with the construction of a Capital Improvement or (ii) an Uncapped O&M Cost payable over the next Fiscal Year in equal monthly installments.

- (e) Following the final determination of the Concession Compensation and KPI Compensation, (i) if the Concession and KPI Compensation Balance is positive, then the University shall pay, within ninety (90) Days of such final determination, to UMLLC, the Concession and KPI Compensation Balance or add such amount to the immediately succeeding payment of the Utility Fee in accordance with Section 15.3(d), if applicable or (ii) if the Concession and KPI Compensation Balance is negative, then UMLLC shall pay, within ninety (90) Days of such final determination, to the University, the absolute amount of the Concession and KPI Compensation Balance or, with the University's consent, offset such amount against the immediately succeeding payment of the Utility Fee, if applicable.
- (f) For the determination of the Concession and KPI Compensation Balance for the Compensation Calculation Date that is the End Date, the Concession Compensation shall also include all Unrecovered Balances as of the End Date, unless this University Lease is terminated as a result of a UMLLC Default, in which case no Unrecovered Balances shall be included in the Concession and KPI Compensation Balance.

Section 15.4. KPI Compensation. Other than the University's right to cause UMLLC to remove the Operator pursuant to Section 3.3(c), the payment of KPI Compensation by UMLLC shall constitute UMLLC's sole and exclusive liability and the University's sole and exclusive remedy for any KPI Event.

Section 15.5. Maximum Annual Amount of KPI Compensation. Notwithstanding anything to the contrary contained herein, the maximum amount of KPI Compensation for which UMLLC may be liable in any given Fiscal Year shall be the greater of (a) ten percent (10%) of the Utility Fee otherwise payable during such Fiscal Year, or (b) two million five hundred thousand dollars (\$2,500,000); *provided that* any KPI Compensation in excess of such cap in any Fiscal Year for which UMLLC would otherwise be liable shall become due and owing in the subsequent Fiscal Year (but subject to the same cap in such Fiscal Year) until the earlier of (x) the second (2nd) anniversary of the Fiscal Year in which the KPI Compensation was incurred and (y) the time that all such outstanding amounts are paid to the University pursuant to this Section 15.5, and such deferred amounts shall accrue interest at a rate equal to the lesser of (A) the sum of the Bank Rate plus three percent (3%) per annum and (B) the maximum interest rate permitted by Law. For the avoidance of doubt, the limitation on the maximum amount of KPI Compensation shall not limit the number of KPI Events that have occurred, including the determination of the number of KPI Events in a Fiscal Year for purposes of Section 3.3 or the determination of future KPI Compensation.

ARTICLE 16 DEFAULTS

Section 16.1. Default by UMLLC.

- (a) *Events of Default.* The occurrence of any one or more of the following events during the Term shall constitute a "UMLLC Default" under this University Lease:

- (i) UMLLC fails to comply with, perform or observe any material obligation, covenant, agreement, term, or condition in this University Lease (other than a breach of the Performance Standards, a KPI Event, or a breach of Section 21.1(a)), and such failure continues unremedied for a period of ninety (90) Days following notice thereof (giving particulars of the failure in reasonable detail) from the University to UMLLC or for such longer period as may be reasonably necessary to cure such failure, provided, in the latter case, that UMLLC has demonstrated to the satisfaction of the University, that (A) it is proceeding, and will proceed, with all due diligence to cure or cause to be cured such failure, (B) its actions can be reasonably expected to cure or cause to be cured such failure within a reasonable period of time acceptable to the University, and (C) such failure is, in fact, cured within such period of time;
- (ii) UMLLC fails to remedy any Transfer of this University Lease or all or any portion of the UMLLC Interest in contravention of Article 17 within ten (10) Business Days following notice thereof from the University to UMLLC;
- (iii) UMLLC fails to comply with the requirements or directives of a final award in a matter submitted to dispute resolution in accordance with Article 18, and such failure continues unremedied for a period of [fifty (50)] Days following notice thereof from the University to UMLLC, or for such longer period as may be reasonably necessary to cure such failure, provided, in the latter case, that UMLLC has demonstrated to the satisfaction of the University, that (A) it is proceeding, and will proceed, with all due diligence to cure or cause to be cured such failure, (B) its actions can be reasonably expected to cure or cause to be cured such failure within a reasonable period of time acceptable to the University, and (C) such failure is, in fact, cured within such period of time;
- (iv) UMLLC (A) admits, in writing, that it is unable to pay its debts as such become due, (B) makes an assignment for the benefit of creditors, (C) files a voluntary petition under Title 11 of the United States Code, or such petition is filed against it and an order for relief is entered, or UMLLC files any petition or answer seeking, consenting to or acquiescing in any reorganization, arrangement, composition, readjustment, liquidation, dissolution, or similar relief under the present or any future United States Bankruptcy Code or any other present or future applicable Law, or shall seek or consent to or acquiesce in or suffer the appointment of any trustee, receiver, custodian, assignee, sequestrator, liquidator, or other similar official of UMLLC or of all or any substantial part of its properties or of the Utility System or any interest therein, or (D) takes any corporate action in furtherance of any action described in this Section 16.1(a)(iv);
- (v) within ninety (90) Days after the commencement of any proceeding against UMLLC seeking any reorganization, arrangement, composition,

readjustment, liquidation, dissolution, or similar relief under the present or any future United States Bankruptcy Code or any other present or future applicable Law, such proceeding has not been dismissed, or, within ninety (90) Days after the appointment, without the consent or acquiescence of UMLLC, of any trustee, receiver, custodian, assignee, sequestrator, liquidator or other similar official of UMLLC or of all or any substantial part of its properties or of the Utility System or any interest therein, such appointment has not been vacated or stayed on appeal or otherwise, or, within ninety (90) Days after the expiration of any such stay, such appointment has not been vacated;

- (vi) a levy under execution or attachment has been made against all or any part of the Utility System or any interest therein as a result of any Encumbrance (other than a Permitted UMLLC Encumbrance) created, incurred, assumed, or suffered to exist by UMLLC or any Person claiming through it, and such execution or attachment has not been vacated, removed or stayed by court order, bonding or otherwise within sixty (60) Days after UMLLC becomes aware of such levy, unless such levy resulted from actions or omissions of the University or its Representatives;
 - (vii) UMLLC Abandons the Initial Modernization Project or otherwise repudiates in writing any of its material obligations under this University Lease;
 - (viii) UMLLC fails to achieve IMP Substantial Completion by the IMP Substantial Completion Long Stop Date, or UMLLC fails to achieve IMP Final Acceptance by the IMP Final Acceptance Long Stop Date, and in either case, such failure continues unremedied for a period of thirty (30) Days following notice thereof (giving particulars of the failure in reasonable detail) from the University to UMLLC; or
 - (ix) UMLLC fails to obtain, provide, or maintain the D&C Security in accordance with the terms of this University Lease and such failure continues unremedied for a period of thirty (30) Days following notice thereof from the University to UMLLC.
- (b) *Remedies of the University upon UMLLC Default.* Upon the occurrence, and during the continuance, of a UMLLC Default, the University may, by notice to UMLLC, declare UMLLC to be in default and may, subject to the provisions of Article 18 and Article 19, do any or all of the following as the University, in its discretion, shall determine:
- (i) subject to the cure rights of the Leasehold Mortgagee set forth in Section 19.3, the University may terminate this University Lease by giving fifty (50) Days' prior notice to UMLLC upon the occurrence of any UMLLC Default; *provided, however*, that UMLLC shall be entitled to cure a UMLLC Default pursuant to Section 16.1(a)(i) or Section 16.1(a)(viii) by

- (i) agreeing within such fifty (50) -Day period to pay any Losses sustained as a result of such UMLLC Default and (ii) providing the University with a written work plan within such fifty (50) -Day period outlining the actions by which UMLLC will ensure future compliance with either (x) the obligation, covenant, agreement, term or condition in this University Lease or (y) the requirements or directives of the issued final award in accordance with Article 18 that UMLLC failed to perform or observe, which work plan is Approved by the University, but any failure of UMLLC to comply in any material respect with such Approved work plan (other than as a result of a Delay Event) following thirty (30) Days' notice of such failure from the University to UMLLC shall be deemed to be a UMLLC Default described in Section 16.1(a)(i) or Section 16.1(a)(viii), as applicable, and the entitlement of UMLLC to cure such UMLLC Default by the delivery of an Approved work plan shall not apply thereto;
- (ii) if UMLLC Default is by reason of the failure to pay any monies to another Person, the University may (without obligation to do so) make payment on behalf of UMLLC of such monies unless such non-payment is due to a bona fide dispute, and any amount so paid by the University shall be payable by UMLLC to the University within three (3) Business Days after demand therefor;
- (iii) subject to the cure rights of the Leasehold Mortgagee set forth in Section 19.3, the University may cure UMLLC Default (but this shall not obligate the University to cure or attempt to cure a UMLLC Default or, after having commenced to cure or attempted to cure a UMLLC Default, to continue to do so), and all costs and expenses reasonably incurred by the University in curing or attempting to cure UMLLC Default, shall be payable by UMLLC to the University within three (3) Business Days after written demand therefor; *provided, however*, that: (A) the University shall not incur any liability to UMLLC for any act or omission of the University or any other Person in the course of remedying or attempting to remedy any UMLLC Default unless resulting from the University's recklessness, gross negligence or willful misconduct; (B) the University's cure of any UMLLC Default shall not affect the University's rights against UMLLC by reason of UMLLC Default; and (C) the University may seek specific performance, injunction, or other equitable remedies, it being acknowledged that damages are an inadequate remedy for a UMLLC Default;
- (iv) The University may seek to recover its Losses arising from such UMLLC Default and any amounts due and payable under this University Lease and, in connection therewith, exercise any recourse available to any Person who is owed damages or a debt;
- (v) with respect to those UMLLC Defaults that entitle the University to terminate this University Lease pursuant to Section 16.1(b)(i), the University may terminate UMLLC's right to use, operate, maintain,

possess, control, and rehabilitate the Utility System and UMLLC's right to collect from the University and retain the Utility Fee, and in such event, the University or the University's agents and servants may immediately or at any time thereafter take possession and control of the Utility System, by any available action under Law or proceeding at law or in equity, and with or without terminating this University Lease, and undertake any and all of the Utility System Operations; *provided, however*, that no such action by the University shall be construed as an election on its part to terminate this University Lease unless a notice of such intention is given to UMLLC; and

- (vi) The University may exercise any of its other rights and remedies provided for hereunder or at law or equity.

Section 16.2. Default by the University.

- (a) *Events of Default.* The occurrence of any one or more of the following events during the Term shall constitute a "UMLLC Default" under this University Lease:
 - (i) The University fails to pay the Utility Fee, the Forecast Utility Fee or the Concession and KPI Compensation Balance to the extent the University is required to do so pursuant to Section 15.3(f), each in accordance herewith and such failure continues unremedied for a period of five (5) Business Days following notice thereof (giving particulars of the failure in reasonable detail) from UMLLC to the University;
 - (ii) The University fails to comply with or observe any material obligation, covenant, agreement, term, or condition in this University Lease (other than an Adverse Action or the payment of the Utility Fee, the Forecast Utility Fee or the Concession and KPI Compensation Balance to the extent the University is required to do so pursuant to Section 15.3(f)) and such failure continues unremedied for a period of ninety (90) Days following notice thereof (giving particulars of the failure in reasonable detail) from UMLLC to the University or for such longer period as may be reasonably necessary to cure such failure, provided, in the latter case, that the University has demonstrated to the satisfaction of UMLLC, that (A) it is proceeding with all due diligence to cure or cause to be cured such failure, (B) its actions can be reasonably expected to cure or cause to be cured such failure within a reasonable period of time acceptable to UMLLC, and (C) such failure is, in fact, cured within such period of time;
 - (iii) The University fails to comply with the requirements or directives of a final award in a matter submitted to dispute resolution in accordance with Article 18 and such default continues unremedied for a period of fifty (50) Days following notice thereof from UMLLC to the University, or for such longer period as may be reasonably necessary to cure such failure, provided, in the latter case, that the University has demonstrated to the satisfaction of UMLLC, acting reasonably, that (A) it is proceeding, and will proceed, with

all due diligence to cure or cause to be cured such failure, (B) its actions can be reasonably expected to cure or cause to be cured such failure within a reasonable period of time acceptable to UMLLC, acting reasonably and (C) such failure is, in fact, cured within such period of time;

- (iv) a levy under execution or attachment has been made against all or any part of the Utility System or the UMLLC Interest as a result of any Encumbrance (other than a Permitted University Encumbrance) created, incurred, assumed or suffered to exist by the University or any Person claiming through it, and such execution or attachment has not been vacated, removed or stayed by court order, bonding or otherwise within a period of sixty (60) Days, unless such levy resulted from actions or omissions of UMLLC or its Representatives or all or a material part of the Utility System shall be subject to a condemnation or similar taking by the University or any agency thereof;
 - (v) The University (A) admits, in writing, that it is unable to pay its debts as such become due, (B) makes an assignment for the benefit of creditors, (C) files a voluntary petition under Title 9 of the United States Code, or such petition is filed against it and an order for relief is entered, or the University files any petition or answer seeking, consenting to or acquiescing in any reorganization, arrangement, composition, readjustment, liquidation, dissolution, or similar relief under the present or any future United States Bankruptcy Code or any other present or future applicable Law, or shall seek or consent to or acquiesce in or suffer the appointment of any trustee, receiver, custodian, assignee, sequestrator, liquidator, or other similar official of the University, or of all or any substantial part of its properties (in each case, to the extent applicable to a municipality), or (D) takes any action in furtherance of any action described in this Section 16.2(a)(v); or within ninety (90) Days after the commencement of any proceeding against the University seeking any reorganization, arrangement, composition, readjustment, liquidation, dissolution, or similar relief under the present or any future United States Bankruptcy Code or any other present or future applicable Law, such proceeding has not been dismissed, or, within ninety (90) Days after the appointment, without the consent or acquiescence of the University, of any trustee, receiver, custodian, assignee, sequestrator, liquidator, or other similar official of the University or of all or any substantial part of its properties (in each case, to the extent applicable to a municipality), such appointment has not been vacated or stayed on appeal or otherwise, or, within ninety (90) Days after the expiration of any such stay, such appointment has not been vacated; or
 - (vi) The University repudiates in writing any of its material obligations under this University Lease.
- (b) *Remedies of UMLLC Upon UMLLC Default.* Upon the occurrence, and during the continuance, of a UMLLC Default, UMLLC may by notice to the University

declare the University to be in default and may, subject to the provisions of Article 18, do any or all of the following as UMLLC, in its discretion, shall determine:

- (i) terminate this University Lease by giving ninety (90) Days' prior notice to the University; *provided, however*, that the University shall be entitled to cure a UMLLC Default pursuant to Section 16.2(a)(ii) or Section 16.2(a)(iii) by (i) agreeing within such sixty (60) -Day period to pay any Losses sustained as a result of such UMLLC Default or (ii) providing UMLLC with a written work plan within such sixty (60) -Day period outlining the actions by which the University will ensure future compliance with either (x) the obligation, covenant, agreement, term, or condition in this University Lease that the University failed to perform or observe or (y) the requirements or directives of the final award issued in accordance with Article 18 that the University failed to perform or observe, which work plan is approved by UMLLC, but any failure of the University to comply in any material respect with such approved work plan following thirty (30) Days' notice of such failure from UMLLC to the University shall be deemed to be a UMLLC Default described in Section 16.2(a)(ii) and the entitlement of the University to cure such UMLLC Default by the delivery of an approved work plan shall not apply thereto; and upon such termination, the University shall be obligated to pay to UMLLC the Utility System Concession Value plus, without duplication, the unpaid Concession and KPI Compensation Balance (for the avoidance of doubt, including any Unrecovered Balances) and the out-of-pocket and documented costs and expenses incurred by UMLLC as a result of such termination together with any Taxes payable by UMLLC on the foregoing that exceed the Taxes UMLLC would have paid on future receipts of the Utility Fee if the termination of this University Lease pursuant to this Section 16.2(b)(i) had not occurred (using the Tax rates in effect when such damages would be payable);
- (ii) exercise any of its rights or remedies at law or in equity;
- (iii) seek to recover its Losses and any amounts due and payable under this University Lease and, in connection therewith, exercise any recourse available to any Person who is owed damages or a debt; and
- (iv) seek specific performance, injunction or other equitable remedies, it being acknowledged that damages are an inadequate remedy for a UMLLC Default.

Section 16.3. Consequences of Termination or Reversion. Upon the termination or expiration of this University Lease, notwithstanding any claims the Parties may have against each other and subject to Section 16.2(b)(iii), the following provisions shall apply:

- (a) UMLLC shall, without action whatsoever being necessary on the part of the University (other than any payment obligations of the University with respect to such termination (including, for the avoidance of doubt, any payment obligations

pursuant to Sections 14.2(a), 15.3(f) or 16.2(b)(i), if any, and the payment obligation set forth in this Section 16.3(a), surrender, transfer and deliver to the University the Utility System (including all improvements to the Utility System), the Utility System Assets and all tangible and intangible personal property of UMLLC (including inventories) that is included in the Utility System or used in connection with the Utility System Operations, in good order, condition and repair (reasonable wear and tear excepted), determined reasonably in accordance with the then applicable Performance Standards, free and clear of all Encumbrances other than (w) Permitted UMLLC Encumbrances set forth in clauses (iv) and (vii) of the definition of that term, (x) Permitted University Encumbrances, (y) those created by or suffered to exist or consented to by the University or any Person claiming through it, and (z) with respect to any property added to the Utility System after the Time of Turnover, title defects affecting such property in existence on the date such property is added to the Utility System, all in exchange for one dollar (\$1) paid by the University on the Reversion Date;

- (b) UMLLC hereby waives any notice now or hereafter required by Law with respect to transfer of the Utility System on the Reversion Date;
- (c) The University shall, as of the Reversion Date, assume full responsibility for the Utility System Operations, and as of such date, UMLLC shall have no liability or responsibility for Utility System Operations occurring after such date;
- (d) UMLLC shall be liable for all costs, expenses and other amounts for which it is liable or responsible hereunder incurred up to but not including the Reversion Date, and the University shall be liable for all costs, expenses and amounts incurred in connection with the Utility System Operations on and after the Reversion Date;
- (e) The University shall have the option, subject to the rights of any Leasehold Mortgagee, or its designee or nominee, to enter into a New Agreement with a third party, by providing notice to UMLLC requiring that UMLLC assign, without warranty or recourse to UMLLC, to the fullest extent permitted by Authorizations and applicable Law, all of its right, title and interest in, to and under (in each of the following cases, to the extent assignable) all or any of the Operating Agreements then in effect and all Authorizations to the University or its nominee for the remainder of their respective terms; *provided, however*, that if the University exercises such option, the right, title and interest of UMLLC in, to and under such Operating Agreements and Authorizations shall be assigned to the University or its nominee as of the Reversion Date and UMLLC shall surrender the Utility System to the University and shall cause all Persons claiming under or through UMLLC to do likewise, and the University shall assume in writing, pursuant to an assumption agreement satisfactory to UMLLC, UMLLC's obligations under the Operating Agreements that arise in respect of, or relate to, any period of time falling on and after the Reversion Date; *provided further*, that if the University does not exercise such option, UMLLC shall take such steps as are necessary to terminate the Operating Agreements to the extent permitted thereunder and in accordance with the terms thereof;

- (f) UMLLC, at its sole cost and expense, shall promptly deliver to the University copies of all records and other documents relating to the Utility Fee that are in the possession of UMLLC or its Representatives and all other then-existing records and information relating to the Utility System as the University, acting reasonably, may request;
- (g) UMLLC shall execute and deliver to the University transfer of title documents and other instruments reasonably required by the University to evidence such termination;
- (h) UMLLC shall assist the University in such manner as the University may require to ensure the orderly transition of control, operation, management, maintenance and rehabilitation of the Utility System, and shall, if appropriate and if requested by the University, take all steps as may be necessary to enforce the provisions of the Operating Agreements pertaining to the surrender of the Utility System;
- (i) The University and UMLLC shall make appropriate adjustments, including adjustments relating to any Operating Agreements assigned to the University, Utility Fee and other similar charges collected on and after the Reversion Date that are incurred prior to the Reversion Date, and utilities, and any adjustments and payment therefor shall be made by the appropriate Party on the Reversion Date, but shall be subject to readjustment if necessary because of error in matters such as information, calculation, payments and omissions that are identified within the period of one hundred eighty (180) Days following the Reversion Date; *provided, however,* that the University and UMLLC acknowledge that certain adjustments or readjustments may have to be made when a third party provides to the University or UMLLC a final adjustment amount in respect of a matter, and for such matters the adjustment and readjustment date shall each be correspondingly extended;
- (j) if this University Lease is terminated as a result of an Adverse Action, the payment by the University to UMLLC of the amounts required under Article 14 or Article 18 shall constitute full and final settlement of any and all Claims UMLLC may have against the University for and in respect of the termination of this University Lease and upon such payment, UMLLC shall execute and deliver all such releases and discharges as the University may reasonably require to give effect to the foregoing;
- (k) all plans, drawings, specifications and models prepared in connection with construction at the Utility System and in UMLLC's possession and all "as-built" drawings shall become the sole and absolute property of the University, and UMLLC shall promptly deliver to the University all such plans, drawings, specifications and models and all such as-built drawings (but may keep copies of those plans, drawings, specifications and models that were developed by UMLLC or its Representatives); and
- (l) The University and UMLLC shall undertake reasonable efforts to transition UMLLC Utility System Employees to the University, or their designee, subject to the University's then-applicable employment policies and legal requirements.

This Section 16.3 shall survive the expiration or any earlier termination of this University Lease.

Section 16.4. Termination Other than Pursuant to Agreement. If this University Lease (i) is terminated by the University other than pursuant to Section 16.1, (ii) is canceled, rescinded or voided during the Term for any reason over the objection and without action by UMLLC, or (iii) terminates as provided in Section 11.15(c), then the University shall (without limiting any payment obligations set forth in Section 15.3(f)) pay to UMLLC the Utility System Concession Value as of the date of such termination, cancellation, rescinding, or voiding, plus, without duplication, (A) unpaid Concession and KPI Compensation Balance (for the avoidance of doubt, including any Unrecovered Balances), and (B) the out-of-pocket and documented costs and expenses incurred by UMLLC or the Operator as a direct result of such termination, cancellation, rescinding, or voiding, and (C) any Taxes payable by UMLLC on the foregoing (A) through (B) that exceed the Taxes UMLLC would have paid on future receipts of the Utility Fee if the termination of this University Lease pursuant to this Section 16.4 had not occurred (using the Tax rates in effect when such damages would be payable). The University hereby acknowledges and agrees that it may only terminate this University Lease in accordance with the express terms hereof and shall not, in any event, have the right to terminate this University Lease for convenience. UMLLC hereby acknowledges and agrees that it may only terminate this University Lease in accordance with the express terms hereof and shall not, in any event, have the right to terminate this University Lease for convenience or to challenge the validity or enforceability of this University Lease. For the avoidance of doubt, the termination of this University Lease as provided in Section 11.15(c) shall not constitute termination for convenience by either the University or UMLLC.

ARTICLE 17 RESTRICTIONS ON TRANSFERS

Section 17.1. Transfers by UMLLC.

- (a) Subject in all respects to the collateral assignment of the UMLLC Interest to a Leasehold Mortgagee, and exercise by a Leasehold Mortgagee of its rights pursuant to such assignment, including by foreclosure, as set forth in Article 19, UMLLC shall not permit the Transfer of any part of the UMLLC Interest to or in favor of a Transferee (other than a Transferee that is an Affiliate or a Leasehold Mortgagee under or nominee/designee of a Leasehold Mortgagee under Article 19), unless the University Liaison has Approved such Transfer in his or her sole discretion. Any Transfer made in violation of this Section 17.1(a) shall be null and void ab initio and of no force and effect. Subject to Section 17.1(f), in no event shall UMLLC permit a Transfer of the UMLLC Interest to a Restricted Person.
- (b) [Intentionally Omitted.]
- (c) [Intentionally Omitted.]
- (d) No Transfer of all or any of the UMLLC Interest (except for a Transfer to a Leasehold Mortgagee or its nominee upon its exercise of remedies under the

Leasehold Mortgage and any subsequent transfer to the transferee of the Leasehold Mortgagee that has been Approved as provided in Section 17.1(a) shall be made or have any force or effect without the University's prior written approval, in its sole discretion.

- (e) Other than a Change in Control occasioned by the exercise by any Leasehold Mortgagee of its remedies under any pledge of shares, limited liability company interest or partnership interest, UMLLC shall not cause or suffer to exist any Change in Control of UMLLC without the University's prior written approval, in its sole discretion.
- (f) Nothing contained in the foregoing shall be deemed to prohibit or limit UMLLC from changing its name, organizational form or status (including a change from a limited liability company to a corporation or limited partnership), provided that such change in name, organizational form or status does not result in a Change in Control of UMLLC.
- (g) Notwithstanding anything herein to the contrary, UMLLC shall have the right, and is hereby directed by the University, to enter into the Concession Agreement with Concessionaire.

Section 17.2. Assignment by the University. The University shall have the right to Transfer any or all of its interest in the Utility System and this University Lease (a) without UMLLC's consent, to any Person that (i) is a successor to the University or similarly organized under and operated for the public educational purposes of the University, (ii) has (A) the sources of funding available for the payment of Concession Compensation (including AA-Compensation) that are at least as adequate and secure as the University's at the time of the assignment, and (B) has access to debt markets that is at least as adequate as the University's at the time of the assignment, and (iii) is able to receive such assignment without causing, directly or indirectly, UMLLC to experience any adverse tax consequence as a result of such assignment, or (b) to others with the prior consent of UMLLC; *provided* that, in either of the foregoing clauses (a) or (b), the University shall be jointly and severally liable with such proposed transferee for the performance and observance of the obligations and covenants of the University under this University Lease, and any agreement entered into by the University under this University Lease (including agreeing directly with any Leasehold Mortgagee to be bound by the agreement entered into in accordance with Section 19.3) and that any such Transfer by the University shall not materially limit or reduce any of UMLLC's other rights, benefits, remedies, or privileges under this University Lease nor shall it materially impair the University's ability to meet its obligations under this University Lease and, provided further, that any such Transfer shall be subject to the rights and Encumbrances of UMLLC and of the Leasehold Mortgagee under any Leasehold Mortgage.

ARTICLE 18 DISPUTE RESOLUTION

Section 18.1. Scope. Any dispute arising out of, relating to, or in connection with this University Lease shall be resolved as set forth in this Article 18.

Section 18.2. Informal Dispute Resolution Procedures. The Parties shall attempt in good faith to resolve such dispute within fifteen (15) Business Days following receipt by one Party of notice of such dispute from the other Party. If the Parties are unable to resolve the dispute within such period of fifteen (15) Business Days, and upon notice by either Party to the other, the dispute shall be referred to the Designated Senior Person of each Party. The Designated Senior Persons shall negotiate in good faith to resolve the dispute, conferring as often as they deem reasonably necessary. Statements made by Representatives of the Parties during the dispute resolution procedures set forth in this Section 18.2 and in Section 18.3 and documents specifically prepared for such dispute resolution procedures shall be considered part of settlement negotiations and shall not be admissible as evidence in any litigation proceeding between the Parties without the mutual consent of the Parties.

Section 18.3. Mediation. Mediation of a dispute under this University Lease may not be commenced until the earlier of: (i) such time as both of the Designated Senior Persons, after following the procedures set forth in Section 18.2, conclude in good faith that amicable resolution through continued negotiation of the matter does not appear likely; or (ii) fifteen (15) Business Days after the notice referring the dispute to the Designated Senior Persons, pursuant to Section 18.2. If, after such time period, the dispute remains unresolved, the Parties shall attempt to resolve the dispute through mediation administered by the AAA under its Commercial Mediation Procedures before resorting to litigation, as provided by Section 18.4. The Parties agree that any period of limitation applicable to the assertion of a claim shall be deemed tolled during the conduct of informal dispute resolution under Section 18.2 and mediation under this Section 18.3, and that any claim of any Party shall be deemed not to have accrued until the mediation is terminated.

Section 18.4. Litigation. Unless the Parties otherwise agree, if mediation as set forth in Section 18.3 does not resolve the dispute within thirty (30) Business Days following a reference to mediation or such longer period as the Parties may mutually agree, then the Parties shall present the dispute to such court of competent jurisdiction as set forth in Section 20.7.

Section 18.5. Provisional Remedies. No Party shall be precluded from initiating a proceeding in a court of competent jurisdiction for the purpose of obtaining any emergency or provisional remedy to protect its rights that may be necessary and that is not otherwise available under this University Lease or to enforce or execute upon a judgment entered in accordance with this University Lease, including temporary, preliminary and permanent injunctive relief and restraining orders, writs of mandamus, and the appointment of a receiver or receiver and manager in connection with the collection and retention of the Utility Fee.

Section 18.6. Tolling. If a Party receiving a notice of default under this University Lease contests, disputes or challenges the propriety of such notice by making application to the dispute resolution procedure in this Article 18, any cure period that applies to such default shall be tolled for the time period between such application and the issuance of a final award or determination.

ARTICLE 19 LENDERS

Section 19.1. Leasehold Mortgages. UMLLC shall not execute or suffer to incur any Leasehold Mortgage without the University's prior written approval, in its sole discretion. In the

event the University grants such written approval, UMLLC shall have the right, at its sole cost and expense, to grant one or more Leasehold Mortgages, if at the time any such Leasehold Mortgage is executed and delivered to the Leasehold Mortgagee, no UMLLC Default exists and upon and subject to the following terms and conditions:

- (a) a Leasehold Mortgage may not cover any property of, or secure any debt issued or guaranteed by, any Person other than UMLLC or the UMLLC Parent, but may cover shares or equity interests in the capital of UMLLC and any cash reserves or deposits held in the name of UMLLC;
- (b) no Person other than an Institutional Lender shall be entitled to the benefits and protections accorded to a Leasehold Mortgagee in this University Lease; *provided, however,* that lessors and lenders to UMLLC (and lenders to a Leasehold Mortgagee that is a Lessor) may be Persons other than Institutional Lenders so long as any Leasehold Mortgage securing the loans made by such Persons is held by an Institutional Lender acting as collateral agent or trustee;
- (c) no Leasehold Mortgage or other instrument purporting to mortgage, pledge, encumber, or create a lien, charge, or security interest on or against any or all of the UMLLC Interest shall extend to or affect the fee simple interest in the Utility System, the University's interest hereunder or the University's reversionary interests and estates in and to the Utility System or any part thereof; in addition, any termination of this University Lease, following the expiration of the Leasehold Mortgagee's cure period in Section 19.3, if any, without a cure, by UMLLC shall simultaneously terminate the Leasehold Mortgage; *provided, however,* such termination of the Leasehold Mortgage and UMLLC's leasehold interest in the Utility System, shall not affect, modify or terminate UMLLC's obligations to the Leasehold Mortgagee with respect to the Leasehold Mortgage Debt;
- (d) The University shall have no liability whatsoever for payment of the principal sum secured by any Leasehold Mortgage, or any interest accrued thereon or any other sum secured thereby or accruing thereunder, and, except for violation by the University of express obligations set forth herein with respect to the Leasehold Mortgage or in any other agreement with the Leasehold Mortgagee, the Leasehold Mortgagee shall not be entitled to seek any damages or other amounts against the University for any or all of the same;
- (e) The University shall have no obligation to any Leasehold Mortgagee in the enforcement of the rights and remedies of the University under this University Lease or by Law, except as expressly set forth in this University Lease or in any agreement with the Leasehold Mortgagee and unless such Leasehold Mortgagee has provided the University with notice of its Leasehold Mortgage in accordance with the Leasehold Mortgage Notice Requirements;
- (f) each Leasehold Mortgage shall provide that if UMLLC is in default under the Leasehold Mortgage and the Leasehold Mortgagee gives notice of such default to

UMLLC, then the Leasehold Mortgagee shall give written notice of such default to the University;

- (g) subject to the terms of this University Lease and the terms of any direct consent agreement executed by and between the University and Leasehold Mortgagee, all rights acquired by a Leasehold Mortgagee under any Leasehold Mortgage shall be subject and subordinate to all of the provisions of this University Lease and to all of the rights of the University hereunder and the Leasehold Mortgagee shall agree to be bound by the terms of this University Lease to the extent applicable to the Leasehold Mortgagee;
- (h) notwithstanding any enforcement of the security of any Leasehold Mortgage, UMLLC shall remain liable to the University for the payment of all sums owing to the University under this University Lease and the performance and observance of all of UMLLC's covenants and obligations under this University Lease;
- (i) a Leasehold Mortgagee shall not, by virtue of its Leasehold Mortgage, acquire any greater rights or interest in the Utility System than UMLLC has at any applicable time under this University Lease, other than such rights granted expressly to such Leasehold Mortgagee pursuant to this Article 19, and each Leasehold Mortgagee, the University, and UMLLC shall enter into a consent agreement in a form acceptable to all parties; provided that such consent agreement shall be in a customary form and shall include the rights and protections provided to the Leasehold Mortgagees in this University Lease;
- (j) a Leasehold Mortgagee shall, within ten (10) days after receipt of written request from the University, execute an amendment to its recorded Leasehold Mortgage to conform the legal description of the real property encumbered by such Leasehold Mortgage to conform to the legal description in the Memorandum of Sub-Lease to the extent properly modified pursuant to Section 2.8; and
- (k) a Leasehold Mortgagee shall, within ten (10) days after receipt of written request from the University, execute documentation reasonably acceptable to the University releasing any land or other real property owned by the University from the lien of any Leasehold Mortgage such that such land or real property may be conveyed to a third party without being subject to this University Lease or the Leasehold Mortgage, provided such request is accompanied by an affidavit from the University that such land or other real property does not contain any Utility Facilities or Utility System Assets.

While any Leasehold Mortgage is outstanding, the University shall not agree to any amendment or modification of this University Lease that could reasonably be expected to have a material adverse effect on the rights or interests of the Leasehold Mortgagee or agree to a voluntary surrender or termination of this University Lease by UMLLC without the consent of the Leasehold Mortgagee.

Section 19.2. Notices and Payments to Leasehold Mortgagees. Whenever a Leasehold Mortgage exists as to which the University has been provided notice by the holder thereof in accordance with the Leasehold Mortgagee Notice Requirements, the University shall, simultaneously with providing UMLLC any required notice under this University Lease, provide a copy of such notice to such Leasehold Mortgagee, and no such notice to UMLLC shall be effective against the Leasehold Mortgagee until a copy thereof is duly provided to such Leasehold Mortgagee at its address specified in its notice given to the University in accordance with the Leasehold Mortgagee Notice Requirements (or any subsequent change of address notice given to the University pursuant to the requirements of Section 20.1). With respect to a Leasehold Mortgage regarding which the University has been provided notice in accordance with the Leasehold Mortgagee Notice Requirements, unless the Leasehold Mortgagee has otherwise advised the University in writing, all payments to UMLLC to be made by the University under this University Lease shall be made to the institution acting as the collateral agent or depository under the financing secured by such Leasehold Mortgage to the extent the University has been provided the name and mailing address of such institution.

Section 19.3. Leasehold Mortgagee's Right to Cure. The Leasehold Mortgagee shall have a period of ninety (90) Days with respect to any UMLLC Default beyond any cure period expressly provided to UMLLC herein, in which to cure or cause to be cured any such UMLLC Default; *provided, however*, that such ninety (90) -Day period shall be extended if UMLLC Default may be cured but cannot reasonably be cured within such period of ninety (90) Days, and the Leasehold Mortgagee begins to cure such default within such ninety (90) -Day period (or if possession is necessary in order to effect such cure, the Leasehold Mortgagee files the appropriate legal action to commence foreclosure on the liens of the Leasehold Mortgage (or takes other appropriate action to effect a transfer of title to the property subject to such liens) and take possession of the Utility System within such period) and thereafter proceeds with all due diligence to cure such UMLLC Default (including by proceeding with all due diligence to effect such foreclosure and during such foreclosure action (to the extent practicable) and thereafter to effect such a cure) within a reasonable period of time acceptable to the University, acting reasonably; *provided further* that if a Leasehold Mortgagee's right to cure a UMLLC Default has not expired, and the Leasehold Mortgagee is acting to cure such UMLLC Default in accordance with this Section 19.3, then the University shall not exercise its right to terminate this University Lease by reason of such UMLLC Default. In furtherance of the foregoing, the University shall permit the Leasehold Mortgagee and its Representatives the same access to the Utility System as is permitted to UMLLC hereunder. The University shall accept any such performance by a Leasehold Mortgagee as though the same had been done or performed by UMLLC. Any payment to be made or action to be taken by a Leasehold Mortgagee hereunder as a prerequisite to keeping this University Lease in effect shall be deemed properly to have been made or taken by the Leasehold Mortgagee if such payment is made or action is taken by a nominee, agent or assignee of the rights of such Leasehold Mortgagee. Any exercise of the Leasehold Mortgagee's rights to cure hereunder shall not result in the assumption by such Leasehold Mortgagee of UMLLC's obligations hereunder.

Section 19.4. Rights of the Leasehold Mortgagee.

- (a) Subject to the provisions of this University Lease, a Leasehold Mortgagee may (i) enforce its Leasehold Mortgage in any lawful way, (ii) acquire the UMLLC Interest

in any lawful way, or (iii) take possession of in any lawful way and manage the Utility System in accordance with the terms of this University Lease. Upon foreclosure of (or without foreclosure upon exercise of any contractual or statutory power of sale under such Leasehold Mortgage or a deed in lieu) and subject to the provisions of Article 17 (applied to the Leasehold Mortgagee as if it were UMLLC), a Leasehold Mortgagee may Transfer the UMLLC Interest; provided, however, that no Transfer by a Leasehold Mortgagee shall be effective unless the Transfer is made in accordance with Section 17.1. Any Person to whom the Leasehold Mortgagee Transfers the UMLLC Interest (including such Leasehold Mortgagee) shall take the UMLLC Interest subject to all of UMLLC's obligations under this University Lease.

- (b) Except as provided in Section 19.3, unless and until a Leasehold Mortgagee (i) forecloses or has otherwise taken ownership of the UMLLC Interest or (ii) has taken possession or control of the UMLLC Interest, whether directly or by an agent as a mortgagee in possession or a receiver or receiver and manager has taken possession or control of the UMLLC Interest by reference to the Leasehold Mortgage, the Leasehold Mortgagee shall not be liable for any of UMLLC's obligations under this University Lease or be entitled to any of UMLLC's rights and benefits contained in this University Lease, except by way of security; *provided, however*, that the Leasehold Mortgagee shall be entitled to cure any UMLLC Default that requires payment of money by paying such money on UMLLC's behalf, prior to the Leasehold Mortgagee taking possession, control or ownership of the UMLLC Interest. If the Leasehold Mortgagee itself or by an agent or a receiver or a receiver and manager is the owner, or is in control or possession of, the UMLLC Interest, it shall be bound by all liabilities and obligations of UMLLC under this University Lease (including the obligation to engage an Operator). Once the Leasehold Mortgagee goes out of possession or control of the UMLLC Interest or Transfers the UMLLC Interest to another Person in accordance with the provisions of this University Lease, the Leasehold Mortgagee shall cease to be liable for any of UMLLC's obligations under this University Lease accruing thereafter and shall cease to be entitled to any of UMLLC's rights and benefits contained in this University Lease, except, if the Leasehold Mortgage remains outstanding, by way of security.

Section 19.5. Termination of this University Lease; New Agreement.

- (a) Without prejudice to the rights of a Leasehold Mortgagee under Section 19.3, if this University Lease is terminated prior to the expiration of the Term due to a UMLLC Default (in which case the University shall notify the Leasehold Mortgagee of such termination) or if this University Lease is rejected or disaffirmed pursuant to any bankruptcy Law or proceeding or other similar Law or proceedings affecting creditors' rights generally with respect to a bankruptcy proceeding relating to UMLLC or otherwise, the University agrees to enter into a new concession and lease agreement of the Utility System with the Leasehold Mortgagee (or its designee or nominee, provided that such designee or nominee either is controlled by the Leasehold Mortgagee (or by the holders of the Leasehold Mortgage Debt))

or is Approved by the University as Transferee under Section 17.1) for the remainder of the original stated Term upon all of the covenants, agreements, terms, provisions and limitations of this University Lease, without any charge, penalty, assessment or consideration not specifically provided for in this Section 19.5 (the “New Agreement”), effective as of the date of such termination, but only on and subject to the satisfaction of all of the following requirements and conditions: (i) such Leasehold Mortgagee commits in writing to the University, in a notice delivered to the University, within thirty (30) Days after the University delivers the termination notice to Leasehold Mortgagee (or, if later, upon the termination of any cure period granted to the Leasehold Mortgagee pursuant to Section 19.3) or within thirty (30) Days after the effective date of such rejection or disaffirmance, as the case may be, that the Leasehold Mortgagee (or its designee or nominee) will enter into the New Agreement, which notice is accompanied by a copy of such New Agreement, duly executed and acknowledged by the Leasehold Mortgagee (or its designee or nominee); (ii) the Leasehold Mortgagee (or its designee or nominee) pays or causes to be paid to the University, at the time of the execution and delivery of the New Agreement, all amounts which, at the time of the execution and delivery thereof, would have been past-due or due and payable in accordance with the provisions of this University Lease but for such termination; (iii) provided the University furnishes a statement or invoice for such costs the Leasehold Mortgagee pays or causes to be paid to the University all reasonable costs and expenses (including legal, advisory and other fees), Taxes, fees, charges and disbursements paid or incurred by the University in connection with such UMLLC Defaults and termination, the recovery of possession from UMLLC, and in connection with the preparation, execution and delivery of the New Agreement and related agreements and documents specified in such statement or invoice; and (iv) such Leasehold Mortgagee (or its designee or nominee), at the time of such written request, cures all UMLLC Defaults under this University Lease (curable by the payment of money) existing immediately prior to the termination of this University Lease, or, if such UMLLC Defaults cannot be cured by the payment of money, such Leasehold Mortgagee (or its designee or nominee) commits to the University in the New Agreement to proceed both promptly and diligently, upon the execution of the New Agreement, to cure all such other UMLLC Defaults to the extent such UMLLC Defaults are capable of cure by a Person other than the original UMLLC and, if possession is necessary in order to cure such other UMLLC Defaults, to proceed both promptly and diligently to obtain the possession required to cure any such other UMLLC Defaults (and such cure shall be a covenant in the New Agreement).

- (b) Nothing contained in this Section 19.5 shall be deemed to limit or affect the University’s interests in and to such Utility System upon the expiration of the Term of the New Agreement. The provisions of this Section 19.5 shall survive the termination of this University Lease and shall continue in full force and effect thereafter to the same extent as if this Section 19.5 were a separate and independent contract made by the University, UMLLC and the Leasehold Mortgagee and, if the Leasehold Mortgagee satisfies the conditions to execute a New Agreement, from the effective date of such termination of this University Lease to the date of

execution and delivery of the New Agreement, the Leasehold Mortgagee may use and enjoy the leasehold estate created by this University Lease without hindrance by the University, but only on and subject to the terms and provisions of this University Lease.

- (c) If the circumstances described in Section 19.5(a) occur, and the University determines, based on the written legal advice of counsel, that termination of this University Lease and the entry into a New Agreement by and among the University and the Leasehold Mortgagee could violate applicable provisions of the Laws of the State of Louisiana governing procurement by the University then, in lieu of entering in a New Agreement and in satisfaction of its obligations under this Section 19.5, the University agrees to enter into an Assignment and Assumption Agreement pursuant to Section 19.8.

Section 19.6. Recognition of Leasehold Mortgagee. If there is more than one Leasehold Mortgagee, only that Leasehold Mortgagee (who, for the avoidance of doubt, may act on behalf of one or more lender groups as contemplated by Section 19.1), to the exclusion of all other Leasehold Mortgagees, whose notice was earliest received by the University pursuant to the Leasehold Mortgagee Notice Requirements, shall have the right to exercise the rights as a Leasehold Mortgagee under this Article 19 vis-à-vis the University, unless such Leasehold Mortgagee has designated in writing another Leasehold Mortgagee to exercise such rights in which case the other Leasehold Mortgagee may exercise such rights, provided that such requirement shall not limit such additional Leasehold Mortgagees' rights hereunder. Such Leasehold Mortgagee may act as agent for a group or syndicate of one or more Institutional Lenders and such Leasehold Mortgagee and Institutional Lenders may freely assign or sell interests and/or participations in the loans to any other Institutional Lender.

Section 19.7. The University's Right to Purchase Leasehold Mortgages.

- (a) If any default by UMLLC has occurred under a Leasehold Mortgage and has not been cured within applicable cure periods, or any act, condition or event has occurred which would permit a Leasehold Mortgagee to declare all or part of the indebtedness secured by a Leasehold Mortgage to be immediately due and payable (or, in the case of a Leasehold Mortgage that is a lease, to terminate the lease), then the University shall have thirty (30) Days after the date on which such Leasehold Mortgagee shall serve notice upon the University in writing ("Leasehold Mortgagee's Notice") that such Leasehold Mortgagee intends to commence proceedings to foreclose the Leasehold Mortgage or, in the case of a Leasehold Mortgagee that is a Lessor to terminate the lease with UMLLC (stating the calculation of the purchase price pursuant to Section 19.7(c)), during which thirty (30) -Day period the University shall have the right and option (the "University's Option") to purchase from all Leasehold Mortgagees their Leasehold Mortgages, upon the terms and subject to the conditions contained in this Section 19.7.
- (b) The University's Option shall be exercised by notice served upon UMLLC and all Leasehold Mortgagees within such thirty (30) -Day period. If the University's Option is duly and timely exercised, the University shall purchase and all Leasehold

Mortgagees shall assign their Leasehold Mortgages to the University (or its designee) on the date which is sixty (60) Days after the date on which a Leasehold Mortgagee's Notice is served upon the University. The closing shall take place at a mutually convenient time and place.

- (c) The purchase price payable by the University shall be equal to the aggregate amounts secured by such Leasehold Mortgages (including principal, interest, fees, premiums, Breakage Costs and other costs, expenses (including attorneys' fees) and any other amounts secured thereby) as of the closing date of the purchase. The purchase price shall be paid in full in cash at closing by wire transfer or other immediately available funds. The purchase price shall be paid by the University to each respective Leasehold Mortgagee, to be applied by the Leasehold Mortgagee to the amounts secured by the Leasehold Mortgage owed to such Leasehold Mortgagee, subject to the priorities of lien of such Leasehold Mortgages.
- (d) At the closing and upon payment in full of the purchase price each Leasehold Mortgagee shall assign its Leasehold Mortgage to the University, together with any security interest held by it in the UMLLC Interest, without recourse, representations, covenants or warranties of any kind, provided that such Leasehold Mortgages and security interests shall be deemed modified to secure the amount of the aggregate purchase price paid by the University to all Leasehold Mortgagees (rather than the indebtedness theretofore secured thereby) payable on demand, with interest and upon the other items referred to in this Section 19.7(d). Each such assignment shall be in form for recordation or filing, as the case may be. The University shall be responsible for paying any Taxes payable to any Governmental Authority upon such assignment. Such assignment shall be made subject to such state of title of the Utility System as shall exist at the date of exercise of the University's Option.
- (e) Any Leasehold Mortgage shall contain an agreement of the Leasehold Mortgagee to be bound by the provisions of this Section 19.7, and the University shall have the right to receive all notices of default under any Leasehold Mortgage.

Section 19.8. Assignment and Assumption Agreement.

- (a) The provisions of this Section 19.8 shall be in effect whenever either (i) the University has made the determination contemplated by Section 19.5(c) or (ii) the University, with the written consent of the Leasehold Mortgagee, has determined to proceed under this Section 19.8 in lieu of under Section 19.5.
- (b) Without prejudice to the rights of a Leasehold Mortgagee under Section 19.3, if either (i) the University has given a notice of termination of this University Lease due to UMLLC Default pursuant to Section 16.1(b), or (ii) this University Lease is rejected or disaffirmed pursuant to any bankruptcy Law or proceeding or other similar Law or proceedings affecting creditors' rights generally with respect to a bankruptcy proceeding relating to UMLLC or otherwise, the University agrees to cooperate with a Leasehold Mortgagee in order to effectuate such Leasehold

Mortgagee's rights under the Leasehold Mortgage to step-in, assume or assign this University Lease, in accordance with the procedures, terms and conditions of this Section 19.8 without any charge, penalty, assessment, or consideration not specifically provided for in this Section 19.8.

- (c) Upon notification and satisfaction of all of the conditions and requirements in Section 19.8(d), the University agrees that this University Lease shall not be deemed terminated, but may be assumed by a Leasehold Mortgagee or by a designee or nominee of such Leasehold Mortgagee who is either controlled by the Leasehold Mortgagee (or by the holders of the Leasehold Mortgage Debt) or is Approved by the University as a Transferee under Section 17.1, for the remainder of the original stated Term of this University Lease, and as evidence of such assignment and assumption the University agrees to execute an amended and restated concession and lease agreement for the Utility System upon all of the covenants, agreements, terms, provisions and limitations of this University Lease (the "Assignment and Assumption Agreement").
- (d) This University Lease may be so assigned and assumed pursuant to an Assignment and Assumption Agreement upon and subject to satisfaction of all of the following requirements and conditions:
 - (i) Such Leasehold Mortgagee must commit in writing to the University, in a notice delivered to the University within the later of thirty (30) Days after the University delivers the termination notice to Leasehold Mortgagee or upon the termination of any cure period granted to such Leasehold Mortgagee pursuant to Section 19.3, or within thirty (30) Days after the effective date of any rejection or disaffirmance of this University Lease in a bankruptcy proceeding, as the case may be, that such Leasehold Mortgagee (or its designee or nominee) will assume this University Lease and enter into the Assignment and Assumption Agreement, which notice is accompanied by a copy of such Assignment and Assumption Agreement duly executed and acknowledged by such Leasehold Mortgagee (or its designee or nominee).
 - (ii) Such Leasehold Mortgagee (or its designee or nominee) shall pay or cause to be paid to the University, at the time that the Assignment and Assumption Agreement is fully executed, all amounts which, at the time of the execution and delivery thereof, would have been past-due or due and payable in accordance with the provisions of this University Lease.
 - (iii) Such Leasehold Mortgagee (or its designee or nominee) shall pay or cause to be paid to the University all reasonable costs and expenses (including legal fees), Taxes, fees, charges and disbursements paid or incurred by the University in connection with such defaults and notice of termination, the recovery of possession from UMLLC, and in connection with the preparation, execution and delivery of the Assignment and Assumption Agreement and related agreements and documents. The University shall

provide an invoice to such Leasehold Mortgagee of such costs, and the Leasehold Mortgagee or its designee or nominee shall pay such invoiced costs within five (5) Days of the receipt of such invoice.

- (iv) Such Leasehold Mortgagee (or its designee or nominee), at the time of the notice provided under Section 19.8(d)(i), shall cure all UMLLC Defaults under this University Lease (including all such UMLLC Defaults curable by the payment of money) existing immediately prior to the notice of termination issued pursuant to Section 16.1(b), or, if such UMLLC Defaults cannot be cured by the payment of money, such Leasehold Mortgagee (or its designee or nominee) shall commit to the University in the Assignment and Assumption Agreement to proceed both promptly and diligently, upon the execution of the Assignment and Assumption Agreement, to cure all such other defaults to the extent such defaults are capable of cure by a Person other than the original UMLLC and, if possession is necessary in order to cure such other UMLLC Defaults, to proceed both promptly and diligently to obtain the possession required to cure any such other defaults (and such obligation to cure shall be a covenant in the Assignment and Assumption Agreement).
- (e) If a Leasehold Mortgagee gives the University a notice as provided in Section 19.8(d)(i), the University and Leasehold Mortgagee agree to cooperate with respect to taking any appropriate actions required to regain and transfer possession of the Utility System and the Utility System Assets, including (i) seeking surrender of possession in any bankruptcy proceedings; (ii) seeking relief from any automatic stay in bankruptcy provisions and pursuit of state law remedies to obtain possession and to foreclose on the Leasehold Mortgagee interest and assume UMLLC's position as provided in Section 19.4 of this University Lease; *provided* that any costs incurred by the University under this provision shall be reimbursed by the Leasehold Mortgagee (or its designee or nominee) as provided in Section 19.8(d)(iii).

Section 19.9. Right to Dispute Resolution. In each case specified in this University Lease in which resort to dispute resolution is authorized, a Leasehold Mortgagee shall have the right and privilege if an event of default under the Leasehold Mortgagee then exists and notice has been given to the University as contemplated by Section 19.1(f), in UMLLC's name, place and stead, to obtain and participate in such dispute resolution upon notice to the University in accordance with Article 18; *provided* that the Leasehold Mortgagee agrees to be bound by the outcome of the dispute resolution process.

Section 19.10. Concessionaire Leasehold Mortgage. The University and UMLLC agree and acknowledge that the Concession Agreement allows the Concessionaire the right to grant a "Leasehold Mortgage" (as such term is defined and used in the Concession Agreement) in accordance with the express terms and conditions of Article 19 of the Concession Agreement. The University agrees to reasonably cooperate with UMLLC and Concessionaire with any such Leasehold Mortgage (and related financing) sought by the Concessionaire in accordance with the relevant terms and conditions of the Concession Agreement (including Article 19 thereof), in each

case consistent with the University's obligations under Article 19 of this University Lease as the same would apply to a Leasehold Mortgage approved by the University as contemplated in Section 19.1 hereof, but subject in all cases to the relevant terms, conditions and obligations of the Concessionaire set forth in the Concession Agreement with respect thereto.

ARTICLE 20 MISCELLANEOUS

Section 20.1. Notice. All notices by the University or UMLLC, approvals or consents by the University, and Approvals by UMLLC (each, a "Notice") required or permitted by this University Lease shall be in writing, shall state specifically that they are being given pursuant to this University Lease, and shall be delivered by email, nationally recognized overnight courier service, or certified or registered mail (return receipt requested and postage prepaid) for the attention of the persons and to the addresses or email addresses shown below (or such other persons, address or email addresses as either Party may from time to time designate by a Notice to the other):

(a) In the case of the University:

(i) for delivery by mail:

LSU Facility Services
201 Facilities Services Bldg.
Engineering Lane
Baton Rouge, LA 70803
Attention: Patrick Martin, Assistant Vice President, Real Estate, Public
Partners, & Compliance

With a copy to:

Board of Supervisors of Louisiana State University and
Agricultural and Mechanical College
3810 West Lakeshore Drive, Suite 124
Baton Rouge, LA 70808
Telephone: (225) 578-4126
Facsimile: (225) 578-5524
Attention: Winston DeCuir, General Counsel

(ii) for delivery by e-mail:

Patrick Martin, Assistant Vice President, Real Estate, Public Partners, &
Compliance
Email: pmartin@lsu.edu

With a copy to:

Winston DeCuir, General Counsel

Email: wdecurjr@lsu.edu

(b) in the case of UMLLC:

(i) for delivery by mail:

Utilities Modernization LLC
c/o LSU Real Estate and Facilities Foundation
Attn: Vice President & General Counsel
3796 Nicholson Drive
Baton Rouge, LA 70802

With a copy to:

[•]

(ii) for delivery by email:

Vice President & General Counsel (Foundation)
Email: lgreco@lsufoundation.org

With a copy to:

[•]

Email: [•]

All Notices shall be deemed to have been sent and received (i) on the Day it is delivered, or if such Day is not a Business Day or if the Notice is received after ordinary office hours (time of place of receipt), the Notice shall be deemed to have been sent and received on the next Business Day, or (ii) on the fourth (4th) Business Day after mailing if sent by U.S. registered or certified mail. Each Party shall use commercially reasonable efforts to deliver an electronic copy of each Notice provided by mail in accordance with the foregoing via email to the persons and email addresses designated pursuant to the foregoing to receive Notices provided by email.

All communications other than Notices that are required or permitted by this University Lease shall be in writing, shall state specifically that they are being given pursuant to this University Lease and shall be delivered by email to the persons and email addresses shown below (or such other persons or email addresses as either Party may from time to time designate by a Notice to the other):

(x) in the case of the University:

[•]

Email: [•]

(c) in the case of UMLLC:

[•]

Email: [•]

Section 20.2. Entire Agreement. This University Lease constitutes the entire agreement between the Parties pertaining to the subject matter hereof and supersedes all prior agreements, negotiations, discussions, and understandings, written or oral, between the Parties. There are no representations, warranties, conditions, or other agreements, whether direct or collateral, or express or implied, that form part of or affect this University Lease, or that induced any Party to enter into this University Lease or on which reliance is placed by any Party, except as specifically set forth in this University Lease. The Parties acknowledge and agree that (i) each has substantial business experience and is fully acquainted with the provisions of this University Lease, (ii) the provisions and language of this University Lease have been fully negotiated, and (iii) no provision of this University Lease shall be construed in favor of any Party or against any Party by reason of such provision of this University Lease having been drafted on behalf of one Party rather than the other.

Section 20.3. Amendment. This University Lease may be amended, changed, or supplemented only by a written agreement signed by the Parties.

Section 20.4. Waiver of Rights. Any waiver of, or consent to depart from, the requirements of any provision of this University Lease shall be effective only if it is in writing and signed by the Party giving it, and only in the specific instance and for the specific purpose for which it has been given. No failure on the part of any Party to exercise, and no delay in exercising, any right under this University Lease shall operate as a waiver of such right. No single or partial exercise of any such right shall preclude any other or further exercise of such right or the exercise of any other right.

Section 20.5. Severability. Each provision of this University Lease shall be valid and enforceable to the fullest extent permitted by applicable Law. The invalidity of any one or more phrases, sentences, clauses, or sections contained in this University Lease shall not affect the remaining portions of this University Lease or any part thereof. If any provision of this University Lease or the application thereof to any Person or circumstance is held or deemed to be or determined to be invalid, inoperative, or unenforceable in any particular case in any particular jurisdiction or jurisdictions because it conflicts with any other provision or provisions hereof or of any applicable Law, or public policy, or for any other reason, (i) such circumstance shall not have the effect of rendering the provision in question inoperative or unenforceable in any other case or circumstance, or rendering any other provision or provisions herein contained invalid, inoperative or unenforceable to any extent whatever, and (ii) the Parties shall negotiate in good faith to amend this University Lease to implement the provisions set forth herein. If the Parties cannot agree on an appropriate amendment, either Party may refer the matter for determination pursuant to the dispute resolution procedure in Article 18. If, by means of the dispute resolution procedure, the Parties are unable, as a result of applicable Law, to resolve the matter in a manner that effectively entitles the University to have the same rights after the aforesaid determination of invalidity or unenforceability as before, the University shall have the right to enact, and cause to come into force, any Law to provide for the same or substantially the same rights as were determined to be invalid or unenforceable.

Section 20.6. Governing Law; Waiver of Jury Trial. This University Lease shall be governed by, and interpreted and enforced in accordance with, the Laws in force in the State of Louisiana (excluding any conflict of laws rule or principle which might refer such interpretation to the Laws of another jurisdiction). **EACH OF THE PARTIES HEREBY IRREVOCABLY WAIVES ANY AND ALL RIGHT TO TRIAL BY JURY IN ANY LEGAL PROCEEDING ARISING OUT OF OR RELATED TO THIS UNIVERSITY LEASE OR THE TRANSACTIONS CONTEMPLATED HEREBY.**

Section 20.7. Submission to Jurisdiction. Subject to Article 18, any action or proceeding against any Party relating in any way to this University Lease may be brought and enforced in the state courts in the State of Louisiana in the Parish of East Baton Rouge, and each of the Parties hereby irrevocably submits to the jurisdiction of such courts with regard to any such action or proceeding, and irrevocably waives, to the fullest extent permitted by applicable Law, any objection it may have now or hereafter have to the laying of venue of any such action or proceeding in such courts and any claim that any such action or proceeding brought in any such court has been brought in an inconvenient forum. Service of process on UMLLC may be made either (i) by delivery to UMLLC's registered agent for service of process in the State of Louisiana, or (ii) by such other lawful means under the Laws of the State of Louisiana. Service of process on the University may be made either (i) by delivery to the University's registered agent for service of process in the State of Louisiana, or (ii) by such other lawful means under the Laws of the State of Louisiana. If UMLLC is presented with a request for Documents by any administrative agency or with a subpoena duces tecum regarding any Documents which may be in its possession by reason of this University Lease, UMLLC, unless prohibited by Law, shall give prompt notice to the University. The University may contest such process by any means available to it before such Documents are submitted to a court or other third party; *provided, however*, that UMLLC shall not be obligated to withhold such delivery beyond that time as may be ordered by the court or administrative agency or required by Law, unless the subpoena or request is quashed or the time to produce is otherwise extended.

Section 20.8. Further Acts. The Parties shall do or cause to be done all such further acts and things as may be reasonably necessary or desirable to give full effect to this University Lease. Without limiting the foregoing, each Party will, at any time and from time to time, execute and deliver or cause to be executed and delivered such further instruments and assurances and take such further actions as may be reasonably requested by the other Party in order to cure any defect in the execution and/or delivery of this University Lease.

Section 20.9. Costs. Except as otherwise provided in this University Lease, each Party shall be responsible for its own costs and expenses incurred in connection with performing and observing its obligations and covenants under this University Lease.

Section 20.10. Interest. Any amount payable under this University Lease and not paid when due shall bear interest at a variable nominal rate per annum equal on each Day to the Bank Rate then in effect, from the date such payment is due until payment and both before and after judgment.

Section 20.11. Inurement and Binding Effect. This University Lease shall inure to the benefit of the Parties and their respective permitted successors and assigns and is binding upon the Parties and their respective successors and assigns.

Section 20.12. No Partnership or Third Party Beneficiaries. Except as expressly provided herein to the contrary, nothing contained in this University Lease shall constitute or be deemed to create a partnership, joint venture or principal and agent relationship the Parties, nor shall any term or provision hereof be construed in any way to grant, convey or create any rights or interests to any Person not a party to this University Lease, other than, in the case of Section 3.11, Section 10.2, Section 12.3, Section 13.4, Section 14.2, Section 16.3, Section 17.1, Section 17.2 and Article 19, any Leasehold Mortgagee.

Section 20.13. Cumulative Remedies. The rights, remedies, powers, and privileges herein provided are cumulative and not exclusive of any rights, remedies, powers, and privileges provided by Law, except for the remedies available to the University through UMLLC for a breach of the Performance Standards or a KPI Event under the Concession Agreement, which shall be limited to those expressly set forth in this University Lease and the Concession Agreement. Notwithstanding the foregoing, where this University Lease provides for liquidated damages (except with respect to the liquidated damages described in Section 15.4 and by Section 22.4), such liquidated damages shall be the sole exclusive remedy of the University or UMLLC, as applicable, and the University and UMLLC hereby irrevocably waive any right to assert a claim against the other party based on a legal theory that a remedy provided herein for such breach or act triggering the liquidated damages fails of its essential purpose.

Section 20.14. Counterparts; Electronic Execution. This University Lease may be executed in any number of counterparts which, taken together, shall constitute one and the same agreement. This University Lease shall be effective when it has been executed by each Party and delivered to both Parties. To evidence the fact that it has executed this University Lease, a Party may send a copy of its executed counterpart to the other Party by email or other means of electronic transmission. Such Party shall be deemed to have executed and delivered this University Lease on the date it sent such email or other means of electronic transmission. In such event, such Party shall forthwith deliver to the other Party an original counterpart of this University Lease executed by such Party.

Section 20.15. Time of the Essence. Time is of the essence for this University Lease.

ARTICLE 21 DESIGN AND CONSTRUCTION

Section 21.1. General Duties. In connection with the Initial Modernization Project, UMLLC shall:

- (a) furnish all design, engineering, and other services, provide construction management and all D&C Work, including the supply of all materials, equipment, labor, and installations, and undertake all efforts necessary or appropriate to construct the Initial Modernization Project and maintain it during construction, so

as to achieve IMP Substantial Completion by the IMP Substantial Completion Long Stop Date and IMP Final Acceptance by the IMP Final Acceptance Long Stop Date;

- (b) perform the Construction Work in accordance with the approved Final Design;
- (c) ensure that UMLLC's Representative, or a designated person approved by the University, is present at the Initial Modernization Project at all times during performance of the Construction Work;
- (d) comply with, and require that all Contractors comply with, all requirements of all applicable Laws;
- (e) cooperate with the University and any Governmental Authority with jurisdiction in all matters relating to the applicable portions of the D&C Work, including their review, inspection and oversight of the design and construction;
- (f) provide quality management and quality assurance of all the work in respect of the D&C Work in accordance with [●]; and
- (g) use commercially reasonable efforts to mitigate delay to design and construction of the Initial Modernization Project, including by re-sequencing, reallocating, or redeploying UMLLC's and its Contractors' forces to other work, as appropriate.

Section 21.2. Performance of D&C Work. UMLLC and its Contractor shall perform or cause to be performed the D&C Work in accordance with:

- (a) good industry practice;
- (b) the requirements, terms and conditions set out in this University Lease, including the approved Final Design;
- (c) all applicable Laws; and
- (d) the requirements, terms and conditions set forth in all Authorizations.

Section 21.3. Design Development and Construction Commencement. Except for the development of the Final Design in accordance with Section 2.4(f), neither UMLLC nor its Contractor shall commence any D&C Work until authorized in accordance with Section 22.1(a), Section 22.1(b) and Section 22.1(c).

Section 21.4. Suspension of Construction Work.

- (a) The University shall at any time have the right and authority to suspend, in whole or in part, the Construction Work by written order to UMLLC. Any such written order will be supported by the University's reasons for the required suspension of the Construction Work.

- (b) Any suspension of the Construction Work by the University pursuant to this Section 21.4 will entitle UMLLC to relief pursuant to Section 15.1(c) and constitute a Compensation Event except where the suspension order is made in response to:
- (i) any failure by UMLLC to comply with any applicable Law, safety standard or Authorization (including failure to handle, preserve, and protect archaeological, paleontological, or cultural remains or failure to handle Hazardous Substances, in accordance with applicable Laws and Governmental Approvals);
 - (ii) UMLLC's failure to ensure skilled and experienced personnel are furnished for the proper performance of the Construction Work in accordance with the requirements set out in [●];
 - (iii) UMLLC's failure to provide the University with proof of (i) insurance coverage and payment in accordance with Section 13.3(a) or (ii) the D&C Security; or
 - (iv) the existence of conditions unsafe for workers, other Initial Modernization Project personnel or the general public, including failures to comply with safety standards (but only if such condition does not arise as a direct result of a Compensation Event or an event that entitles UMLLC to relief pursuant to Section 15.1(c)).
- (c) Any suspension order made in response to matters referred to in Section 21.4(b) shall cease to apply as soon as the relevant matter has been rectified or remedied to the reasonable satisfaction of the University.

Section 21.5. Removal of IMP Contractor.

- (a) The IMP Contractor shall, at all times in connection with the design, construction, delivery and completion of the Initial Modernization Project, be under the direction, supervision and control (by ownership, contract or otherwise) of UMLLC, and no delegation by UMLLC or the Concessionaire to the IMP Contractor (including pursuant to the Drop-Down DB Contract) shall relieve UMLLC of any obligations, duties or liability hereunder.
- (b) UMLLC shall have the right, to the extent provided in the Drop-Down DB Contract or any other agreement between UMLLC or the Concessionaire, on the one hand, and the IMP Contractor, on the other, to terminate and replace the IMP Contractor, provided that UMLLC shall not engage or appoint a replacement IMP Contractor unless the University has Approved such replacement IMP Contractor and the terms of any such engagement. UMLLC shall immediately notify the University upon the termination or resignation of the IMP Contractor. The University shall have the right, acting reasonably, to withhold Approval of any proposed replacement IMP Contractor, including for any of the following reasons: (i) the University reasonably determines that the engagement of such proposed IMP Contractor is prohibited by

applicable Law or this University Lease; (ii) the University reasonably determines that such proposed IMP Contractor is not capable of performing the Initial Modernization Project in accordance with this University Lease, which determination may be based upon one or more of the following factors: (1) the ability of the proposed IMP Contractor to construct and deliver the Initial Modernization Project in a manner that complies with the Final Design; (2) the financial strength, capitalization and integrity of the proposed IMP Contractor, its direct or indirect beneficial owners and some or all of their respective Affiliates providing a guaranty of the IMP Contractor's obligations (which guaranty shall not be required to run to the benefit of the University); (3) the experience of the proposed IMP Contractor in performing work and projects substantially similar to the Initial Modernization Project; (4) the background and reputation of the proposed IMP Contractor, its direct or indirect beneficial owners, each of their respective officers, directors and employees and each of their respective Affiliates (including the absence of criminal, civil or regulatory claims or actions against any such Person and the quality of any such Person's past or present performance on other projects); and (5) the proposed terms of the engagement of the proposed IMP Contractor, including the fee being charged by the IMP Contractor, length of the term of the engagement and any restrictions on transfer by the IMP Contractor of its obligations and change in control of the proposed IMP Contractor. No termination or replacement of the IMP Contractor shall relieve UMLLC of any obligations, duties or liability hereunder or extend any time period for UMLLC's performance hereunder.

- (c) A "Change in Control" (as such term is defined and used in the Concession Agreement) of the IMP Contractor shall be deemed to be the appointment of a replacement IMP Contractor subject to the University's Approval pursuant to Section 21.5(b).

Section 21.6. Performance and Payment Security

- (a) Prior to the commencement of D&C Work, UMLLC shall furnish, [or cause the IMP Contractor to furnish,] the following:
- (i) a performance bond (substantially in the form of the most current version of The American Institute of Architects AIA Document 312) in an amount equal to one hundred percent (100%) of the Approved Budgeted Amount for the Initial Modernization Project (the "Performance Bond"); and
 - (ii) a payment bond (substantially in the form of the most current version of The American Institute of Architects AIA Document 312) in an amount equal to one hundred percent (100%) of the Approved Budgeted Amount for the Initial Modernization Project (the "Payment Bond").
- (b) Each of the Performance Bond and the Payment Bond must be issued by a surety or an insurance company authorized to issue bonds in the State that is rated in the top two categories by two of the three nationally recognized rating agencies or at

least “A” or better and “Class VIII” or better according to A.M. Best’s Financing Strength Rating and Financial Size Category and listed on U.S. Treasury Circular 570.

- (c) Each of the Performance Bond and the Payment Bond shall name the State of Louisiana, the University, their agents, officials, and employees, UMLLC and the Leasehold Mortgagee, as their interests may appear as additional obligees. The claims of any such additional obligee with respect each of the Performance Bond and the Payment Bond shall rank *pari passu* in priority with the claims of all other additional obligees.
- (d) UMLLC shall maintain, or cause the IMP Contractor to maintain, each of the Performance Bond and the Payment Bond until the [second (2nd)] anniversary of the IMP Substantial Completion Date.

ARTICLE 22

NOTICES TO PROCEED; IMP SUBSTANTIAL COMPLETION; IMP FINAL ACCEPTANCE

Section 22.1. Notices to Proceed. With respect to the Initial Modernization Project:

- (a) *Notice to Proceed – 1.*
 - (i) The University anticipates issuing a notice to UMLLC (“NTP1”) promptly following approval of the Final Design and the Approved Budgeted Amount for the Initial Modernization Project in accordance with Section 2.4(f), and shall in any case issue NTP1 within three (3) Business Days after approval of the Final Design and such Approved Budgeted Amount.
 - (ii) Following issuance of NTP1, UMLLC is authorized to perform the works and activities specified in Section 1 (*NTP1 Conditions*) of Part 1 of Schedule 21.
- (b) *Notice to Proceed – 2.*
 - (i) Upon satisfaction of the conditions precedent set out in Section 2 of Part 1 (*NTP2 Conditions*) of Schedule 21, the University shall issue a notice to UMLLC (“NTP2”).
 - (ii) Following issuance of NTP2, UMLLC is authorized to perform the works and activities specified in Section 2 (*NTP2*) of Schedule 21.
- (c) *Notice to Proceed – 3.*
 - (i) Upon satisfaction of the conditions precedent set out in Section 3 (*NTP3 Conditions*) of Part 1 of Schedule 21, the University shall issue a notice to UMLLC (“NTP3”).

- (ii) Following issuance of NTP3, UMLLC is authorized to commence all other work and activities pertaining to the Initial Modernization Project, subject to any requirement to obtain acceptance of applicable submittals in accordance with Section 3 (*NTP3 Conditions*) of Part 3 of Schedule 21.
- (iii) If UMLLC has not satisfied all the conditions precedent set out in Section 3 (*NTP3 Conditions*) of Part 1 of Schedule 21, the University may elect to issue a notice to UMLLC authorizing UMLLC to commence certain works prior to the satisfaction of the remaining conditions precedent, as specified and subject to any conditions in the University's notice.

Section 22.2. IMP Substantial Completion.

- (a) The University will issue a written certificate that UMLLC has achieved IMP Substantial Completion upon satisfaction (or waiver by the University, in its sole discretion) of each of the conditions set forth in Part 2 of Schedule 21 and in accordance with the terms of this Section 22.2. On the IMP Substantial Completion Date, the IMP shall be (i) deemed to be part of the Utility System and the Utility System Facilities for purposes of this University Lease, and (ii) included in the Utility System to be operated and the Utility System Services to be performed by UMLLC pursuant to this University Lease.
 - (b) UMLLC shall prepare a detailed plan for the completion of all remaining D&C Work ("D&C Closeout Plan"), which shall include:
 - (i) the SC Punch List and the draft FA Punch List; and
 - (ii) the timetable for carrying out Construction Work, including:
 - (A) the activities to be carried out between IMP Substantial Completion and IMP Final Acceptance and included in the FA Punch List; and
 - (B) any other activities to be carried out after IMP Final Acceptance; and
- UMLLC shall submit the D&C Closeout Plan to the University at least ninety (90) days prior to the date on which UMLLC anticipates achieving IMP Substantial Completion.
- (c) UMLLC shall implement the accepted D&C Closeout Plan and regularly update the SC Punch List and the FA Punch List, provided that UMLLC will not transfer any items from the SC Punch List to the FA Punch List without the prior written acceptance of the University.
 - (d) UMLLC shall provide the University with not less than thirty (30) days' prior written notification of the date UMLLC anticipates achieving IMP Substantial Completion.

- (e) During the thirty (30)-day period specified in Section 22.1(d):
 - (i) UMLLC and the University shall meet and confer and exchange information on a regular cooperative basis and shall at a minimum meet twice a week;
 - (ii) The University may conduct:
 - (A) an inspection of the entire Initial Modernization Project and its components;
 - (B) a review of the IMP Design Documents and Construction Documents; and
 - (C) such other investigation and review of reports, data and documentation as may be necessary to evaluate whether all of the conditions to IMP Substantial Completion have been satisfied; and
 - (iii) UMLLC and the University shall agree the final FA Punch List.
- (f) Within five (5) Business Days of completion of the inspections, reviews and investigations specified in Section 22.1(e)(ii), the University may either:
 - (i) issue the written certificate of IMP Substantial Completion (“Certificate of IMP Substantial Completion”); or
 - (ii) notify UMLLC in writing setting forth, as applicable, why the Initial Modernization Project has not reached IMP Substantial Completion.
- (g) If the University issues a notice under Section 22.1(f)(ii) and UMLLC:
 - (i) does not dispute the University’s assessment, then the processes set forth in Sections 22.2(d), 22.2(e) and 22.2(f) shall be repeated until the University issues a Certificate of IMP Substantial Completion; or
 - (ii) disputes the University’s assessment, UMLLC may refer the dispute for resolution in accordance with Section 18 and:
 - (A) where the dispute is determined in favor of UMLLC, the University shall issue the Certificate of IMP Substantial Completion; or
 - (B) where the dispute is determined in favor of the University, then the processes set forth in Sections 22.2(d), 22.2(e) and 22.2(f) shall be repeated.
- (h) If Sections 22.2(g)(i) or 22.2(g)(ii)(B) apply and the University determines that it does not require the full thirty (30) day period under Section 22.2(e) to re-conduct

relevant inspections and investigations, the University may notify UMLLC that a shorter period will apply.

Section 22.3. IMP Final Acceptance.

- (a) The University will issue a written certificate that UMLLC has achieved IMP Final Acceptance upon satisfaction (or waiver by the University, in its sole discretion) of each of the conditions set forth in Part 3 of Schedule 21 and in accordance with the terms of this Section 22.3.
- (b) Promptly after achieving IMP Substantial Completion, UMLLC shall perform all remaining Construction Work for the Initial Modernization Project in accordance with the accepted D&C Closeout Plan, including completion of all FA Punch List items.
- (c) UMLLC shall provide the University with not less than thirty (30) days' prior written notification of the date UMLLC anticipates achieving IMP Final Acceptance.
- (d) During the thirty (30) day period specified in Section 22.3(c):
 - (i) UMLLC and the University shall meet and confer and exchange information on a regular cooperative basis; and
 - (ii) The University may conduct:
 - (A) an inspection of the FA Punch List items;
 - (B) a review of the Record Design Documents; and
 - (C) such other investigation as may be necessary to evaluate whether the conditions to IMP Final Acceptance are satisfied.
- (e) Within five (5) Business Days of completion of the inspections, reviews and investigations specified in Section 22.3(d)(ii), the University may either:
 - (i) issue a certificate of IMP Final Acceptance ("Certificate of IMP Final Acceptance"); or
 - (ii) notify UMLLC in writing setting forth, as applicable, why IMP Final Acceptance has not been achieved in which case the processes set out in Sections 22.3(c), 22.3(d) and 22.3(e) shall be repeated until the University issues a Certificate of IMP Final Acceptance.

Section 22.4. Liquidated Damages for Failure to Achieve IMP Substantial Completion or IMP Final Acceptance.

- (a) The Parties acknowledge and agree that breaches or failures by UMLLC of the kind identified in this Section 22.4 would cause significant harm to the University, including loss of use, enjoyment and benefit of the Initial Modernization Project, injury to the credibility and reputation of the University with policy makers and with the University community who depend on and expect availability of service, and additional costs of administering this University Lease (including engineering, legal, accounting, overhead and other administrative costs); and that such harm is incapable of being accurately determined. The Parties further acknowledge and agree that the liquidated damages stipulated in this Section 22.4 as remedies for such breaches or failures reasonably approximate the appropriate compensation for the anticipated harm.
- (b) The University's right to, and imposition of, liquidated damages pursuant to this Section 22.4 are in addition, and without prejudice, to any other rights and remedies available to the University under this University Lease, at law or in equity respecting the breach, failure to perform or UMLLC Default that is the basis for the liquidated damages or any other breach, failure to perform or UMLLC Default, except for recovery of the monetary damage that the liquidated damages are intended to compensate. Liquidated damages are not intended to, and do not, liquidate UMLLC's liability under the payment obligation provisions of Section 12, even though third-party claims against Indemnified Parties may arise out of the same event, breach or failure that gives rise to such liquidated damages. Permitting or requiring UMLLC to continue and finish the Construction Work or any part thereof after the Planned IMP Substantial Completion Date or IMP Final Acceptance Deadline shall not act as a waiver of the University's right to receive liquidated damages hereunder or any rights or remedies otherwise available to the University.
- (c) UMLLC shall pay any liquidated damages owing under this Section 22.4 within thirty (30) days after the University delivers invoice or demand therefor to UMLLC. Liquidated damages shall be due and payable to the University without right of offset, deduction, reduction or other charge.
- (d) The amounts set forth in this Section 22.4 shall be increased annually on July 1 of each year by a percentage equal to the percentage increase in the CPI Index between the CPI Index of the second (2nd) immediately preceding year and the CPI Index of the immediately preceding year (in no event shall the amount be less than the amount in effect during the immediately preceding year).
- (e) The University shall be entitled to immediate and automatic liquidated damages from UMLLC equal to [twenty thousand dollars (\$20,000)] per day for each day that the IMP Substantial Completion Date is later than the Planned IMP Substantial Completion Date. Such liquidated damages shall constitute the University's sole right to monetary damages for such delay.
- (f) The University shall be entitled to immediate and automatic liquidated damages from UMLLC equal to [ten thousand dollars (\$10,000)] per day for each day that

the IMP Final Acceptance Date is later than the IMP Final Acceptance Deadline. No liquidated damages shall be owing under this Section 22.4(f) for any day for which liquidated damages are owing under Section 22.4(e). Such liquidated damages shall constitute the University's sole right to monetary damages for such delay.

[Signature page follows]

DRAFT

IN WITNESS WHEREOF, the University and UMLLC have caused this University Lease to be signed by their respective officers thereunto duly authorized as of the date first written above.

**Board of Supervisors of Louisiana State
University and Agricultural and Mechanical
College**

BY: _____

PRINTED: [•]

ITS: [•]

Utilities Modernization LLC,
a Louisiana limited liability company

BY: _____

PRINTED: [•]

ITS: [•]

DRAFT

SCHEDULE 21
Notices to Proceed; Conditions to IMP Substantial Completion and IMP Final Acceptance
of Initial Modernization Project

PART 1 – NOTICES TO PROCEED

Section 1 NTP1 Conditions

(a) Approval by the University of (i) the Final Design and (ii) the Approved Budgeted Amount with respect to the Initial Modernization Project pursuant to Section 4.3(f) of the University Lease;

(b) The D&C Security has been obtained (and copies thereof furnished to the University) and is in full force and effect in accordance with Section 21.6 of the University Lease;

(c) [•]

Section 2 NTP2 Conditions

[•]

Section 3 NTP3 Conditions

[•]

PART 2 – IMP SUBSTANTIAL COMPLETION

1. COMPLETED D&C WORK

UMLLC has completed the D&C Work with respect to the Initial Modernization Project, including all SC Punch List items, in accordance with the approved Final Design, the D&C Closeout Plan, and the terms and conditions of this University Lease, except with respect to any FA Punch List items.

2. FUNCTIONAL UTILITY SYSTEM

- (a) The Utility System, as upgraded via the Initial Modernization Project, is fully operational and capable of being operated full-time, uninterrupted, and continuously in accordance with the [Final Design].
- (b) The Utility System, as upgraded via the Initial Modernization Project, meets the Performance Standards.
- (c) All ancillary items including equipment, supplies, spare parts and manuals are in place for the Utility System, as upgraded via the Initial Modernization Project.
- (d) UMLLC has updated the Operations Plan.
- (e) All establishment and commissioning procedures for the Utility System, as upgraded via the Initial Modernization Project, have been successfully completed in accordance with the testing and commissioning requirements set forth in [●].

3. INSURANCE

All UMLLC Required Coverages required to be obtained under Section 13.1 (*Insurance Coverage Required – UMLLC*) of the University Lease have been obtained and are in full force and effect in accordance with Section 13.1 (*Insurance Coverage Required – UMLLC*) of the University Lease.

4. NO CONCESSIONAIRE DEFAULT

There exists no uncured UMLLC Default that is the subject of a notice, unless the achievement of IMP Substantial Completion will effect its full and complete cure.

5. AUTHORIZATIONS

All Authorizations (if any) required to perform the Utility System Operations with respect to the Utility System, as upgraded via the Initial Modernization Project, are in place, have been provided to the University, and are not subject to appeal.

6. FA PUNCH LIST

UMLLC and the University shall have agreed to the final FA Punch List.

DRAFT

PART 3 – IMP FINAL ACCEPTANCE

1. FA PUNCH LIST

UMLLC has achieved IMP Substantial Completion and completed all FA Punch List items in accordance with the approved Final Design, the D&C Closeout Plan, and the terms and conditions of this University Lease.

2. DEMOBILIZATION

All demobilization from the Property is complete, including the removal of temporary work and equipment used in the performance of the D&C Work, but not required for Utility System Operations.

3. NO CONCESSIONAIRE DEFAULT

There exists no uncured UMLLC Default that is the subject of a notice, unless the achievement of IMP Final Acceptance will effect its full and complete cure.

4. RELEASE OF LIENS

UMLLC has provided evidence to the University that all Contractors have waived any rights to liens against the Utility System and the Property.

5. INSURANCE

All UMLLC Required Coverages required to be obtained under Section 13.1 (*Insurance Coverage Required – UMLLC*) of the University Lease have been obtained and are in full force and effect in accordance with Section 13.1 (*Insurance Coverage Required – UMLLC*) of the University Lease.

6. RECORD DRAWINGS

UMLLC has provided the University with a complete set of [as-built drawings/final Construction Documents], in form and content required by [●].

7. PAYMENTS TO THE UNIVERSITY

UMLLC has paid in full all [liquidated damages] arising or resulting from the D&C Work that are owing to the University pursuant to the University Lease and are not in dispute.

**LONG-TERM SUB-LEASE AND CONCESSION AGREEMENT FOR
LOUISIANA STATE UNIVERSITY UTILITY SYSTEM**

dated as of

[•]

by and between

UTILITIES MODERNIZATION LLC

and

[BATON ROUGE ENERGY CONCESSIONAIRE LLC]

TABLE OF CONTENTS

Page

[Table of Contents to be Updated]

ARTICLE 1 DEFINITIONS AND INTERPRETATION	3
Section 1.1. Definitions	3
Section 1.2. Number and Gender	33
Section 1.3. Headings	33
Section 1.4. References to this Agreement.	33
Section 1.5. References to Any Person	33
Section 1.6. Meaning of Including	33
Section 1.7. Meaning of Discretion	33
Section 1.8. Meaning of Notice.	33
Section 1.9. Consents and Approvals	33
Section 1.10. Trade Meanings.	33
Section 1.11. Laws	33
Section 1.12. Currency.	34
Section 1.13. Generally Accepted Accounting Principles	34
Section 1.14. Calculation of Time	34
Section 1.15. Approvals, Consents and Performance by UMLLC	34
Section 1.16. Incorporation of Schedules.	35
Section 1.17. References to Agreements Generally	35
Section 1.18. Cost Responsibilities	35
Section 1.19. Out-of-Pocket Costs	36
Section 1.20. Interaction with the University Lease	36
Section 1.21. Equivalent Project Relief	37
Section 1.22. Enforcement of Parallel Issues	39
Section 1.23. Pass-Down Provisions	40
Section 1.24. Communications with the University and Third Parties	40
Section 1.25. Louisiana Defined Terms	41
ARTICLE 2 THE TRANSACTION; CONDITIONS PRECEDENT; COVENANTS.....	41
Section 2.1. Grant of Concession	41
Section 2.2. Turnover	42
Section 2.3. Conditions Precedent to Turnover	43
Section 2.4. Covenants	45
Section 2.5. Turnover Deliverables	49
Section 2.6. Memorandum of Sub-Lease	49
ARTICLE 3 TERMS OF THE CONCESSION	50
Section 3.1. Quiet Enjoyment and Present Condition	50
Section 3.2. Utility System Operations	51
Section 3.3. Operator	54
Section 3.4. Authorizations; Qualifications	57
Section 3.5. No Encumbrances	58
Section 3.6. Single Purpose Covenants; Credit Rating	59
Section 3.7. Rights of UMLLC to Access and Perform Work on the Utility System and Utilize Space for Energy Resources and Research Purposes	59
Section 3.8. Payment of Taxes	63

TABLE OF CONTENTS

(continued)

	<u>Page</u>
Section 3.9.	Utilities64
Section 3.10.	Notices of Defaults and Claims65
Section 3.11.	Assignment of Operating Agreements and Plans; Project Intellectual Property65
Section 3.12.	Use of Information and Records.....68
Section 3.13.	Standard of Operation and Maintenance of the Utility System; Warranty Period Utility System Projects69
Section 3.14.	Payments by UMLLC.....69
Section 3.15.	Naming and Signage Rights, Other Revenue Activities and Commercial Advertisements and Activities70
Section 3.16.	Reversion of Utility System71
Section 3.17.	Police, Fire, Emergency and Public Safety Access Rights71
Section 3.18.	Negotiations with Third Parties.....71
Section 3.19.	Administration of the Public Way.....71
Section 3.20.	Rights to Adjacent Space.....71
Section 3.21.	Sole Utility Provider72
Section 3.22.	Adjustments to the Location or Configuration of the Utility System.72
Section 3.23.	Sales to Individual Customers on the University Campus.....73
Section 3.24.	University Master Plan.....73
Section 3.25.	Utility System Tours73
Section 3.26.	Uniforms.....73
Section 3.27.	Sustainability73
Section 3.28.	University Utility System Employees74
Section 3.29.	[Office Space]74
Section 3.30.	Utility System Space in Larger Buildings.....74
ARTICLE 4 CAPITAL IMPROVEMENTS AND MATERIAL CHANGES75
Section 4.1.	Concessionaire Responsibility for Capital Improvements.....75
Section 4.2.	Authorizations Related to Capital Improvements76
Section 4.3.	Approval of Capital Improvements and Material Changes.76
Section 4.4.	UMLLC’s Capital Plan.81
ARTICLE 5 MODIFICATIONS83
Section 5.1.	UMLLC Directives.....83
Section 5.2.	Performance of Modifications84
Section 5.3.	Addition, Removal and Lease of Property84
ARTICLE 6 PERFORMANCE STANDARDS85
Section 6.1.	Compliance with Performance Standards.....85
Section 6.2.	Proposed Performance Standards.....85
Section 6.3.	Modified Performance Standards86
ARTICLE 7 UTILITY FEE, FIVE-YEAR PLAN, AND ENERGY SUPPLY87
Section 7.1.	Utility Fee.....87
Section 7.2.	Five-Year Plan.....89
Section 7.3.	Energy and Water Supply91

TABLE OF CONTENTS

(continued)

	<u>Page</u>
Section 7.4. Energy Use Intensity Reduction and Energy Conservation Measures	93
ARTICLE 8 REPORTING; AUDITS; INSPECTIONS	93
Section 8.1. Reports; Environmental Incident Management	93
Section 8.2. Information	95
Section 8.3. Inspection, Audit and Review Rights of UMLLC	95
Section 8.4. Audits, Assistance, Inspections and Approvals	97
ARTICLE 9 REPRESENTATIONS AND WARRANTIES	98
Section 9.1. Representations and Warranties of UMLLC	98
Section 9.2. Representations and Warranties of the Concessionaire	100
Section 9.3. Non-Waiver	103
Section 9.4. Survival	103
ARTICLE 10 FINANCE OBLIGATIONS	104
Section 10.1. Concessionaire’s Obligations	104
Section 10.2. UMLLC’s Obligations	104
Section 10.3. Concessionaire’s Obligation for Estoppel Certificates	105
Section 10.4. Prohibited Tax Shelter Transactions	105
ARTICLE 11 COMPLIANCE.....	105
Section 11.1. Compliance with Laws	105
Section 11.2. Non-Discrimination	106
Section 11.3. Compliance with Wage and Hour Laws	106
Section 11.4. Safety Laws	106
Section 11.5. Immigration Laws	106
Section 11.6. Labor Disputes	106
Section 11.7. Employee Conduct and Performance	107
Section 11.8. Non-Collusion	107
Section 11.9. Conflict of Interest	107
Section 11.10. Drug-Free Workplace Certification	107
Section 11.11. Minority-Owned and Women-Owned Business Enterprises	107
Section 11.12. Accreditation	108
Section 11.13. Permits and Other Campus-Wide Authorizations	108
Section 11.14. Financial and Audit Standards	108
Section 11.15. Pay If Paid; Non-Appropriation and Termination	109
ARTICLE 12 PAYMENT OBLIGATIONS	110
Section 12.1. Certain Payment Obligations of the Concessionaire	110
Section 12.2. Certain Payment Obligations of UMLLC	110
Section 12.3. Agency for Representatives	111
Section 12.4. Third Party Claims	111
Section 12.5. Direct Claims	112
Section 12.6. Failure to Give Timely Notice	112
Section 12.7. Reductions and Subrogation	112
Section 12.8. Payment and Interest	113
Section 12.9. Limitation on Certain Claims	113

TABLE OF CONTENTS

(continued)

	<u>Page</u>
Section 12.10. Other Matters.....	113
Section 12.11. Offset Rights; Limitations on Certain Damages	114
Section 12.12. Governmental Immunity.....	114
Section 12.13. Survival.....	114
ARTICLE 13 INSURANCE.....	114
Section 13.1. Insurance Coverage Required – Concessionaire.	114
Section 13.2. Insurance Coverage Required – UMLLC.....	117
Section 13.3. Additional Requirements	118
Section 13.4. Damage and Destruction	122
Section 13.5. Additional UMLLC Requirements	126
ARTICLE 14 ADVERSE ACTIONS.....	127
Section 14.1. Adverse Action	127
Section 14.2. Termination.....	128
Section 14.3. Right of UMLLC to Remedy.	129
Section 14.4. Other Actions by Governmental Authorities	130
Section 14.5. Regulatory Filings.....	130
ARTICLE 15 DELAY EVENTS; CONCESSION COMPENSATION AND KPI COMPENSATION	130
Section 15.1. Delay Events	130
Section 15.2. Notice of Compensation Events and KPI Events.....	132
Section 15.3. Payments of Concession Compensation and KPI Compensation	133
Section 15.4. KPI Compensation.....	134
Section 15.5. Maximum Annual Amount of KPI Compensation	134
ARTICLE 16 DEFAULTS	134
Section 16.1. Default by the Concessionaire.....	134
Section 16.2. Default by UMLLC.....	138
Section 16.3. Consequences of Termination or Reversion.....	141
Section 16.4. Termination Other than Pursuant to Agreement.....	143
ARTICLE 17 RESTRICTIONS ON TRANSFERS	143
Section 17.1. Transfers by the Concessionaire.....	143
Section 17.2. Assignment by UMLLC.	146
ARTICLE 18 DISPUTE RESOLUTION	147
Section 18.1. Scope.....	147
Section 18.2. Informal Dispute Resolution Procedures	147
Section 18.3. Mediation.....	147
Section 18.4. Litigation.....	147
Section 18.5. Provisional Remedies.....	147
Section 18.6. Tolling.....	147
ARTICLE 19 LENDERS.....	148
Section 19.1. Leasehold Mortgages.....	148
Section 19.2. Notices and Payments to Leasehold Mortgagees.	150
Section 19.3. Leasehold Mortgagee’s Right to Cure.. ..	150

TABLE OF CONTENTS

(continued)

	<u>Page</u>
Section 19.4. Rights of the Leasehold Mortgagee.....	150
Section 19.5. Termination of this Agreement; New Agreement.....	151
Section 19.6. Recognition of Leasehold Mortgagee.....	153
Section 19.7. UMLLC's Right to Purchase Leasehold Mortgages.....	153
Section 19.8. Assignment and Assumption Agreement.....	154
Section 19.9. Right to Dispute Resolution.....	156
ARTICLE 20 MISCELLANEOUS.....	156
Section 20.1. Notice.....	156
Section 20.2. Entire Agreement.....	158
Section 20.3. Amendment.....	158
Section 20.4. Waiver of Rights.....	158
Section 20.5. Severability.....	158
Section 20.6. Governing Law; Waiver of Jury Trial.....	159
Section 20.7. Submission to Jurisdiction.....	159
Section 20.8. Further Acts.....	159
Section 20.9. Costs.....	160
Section 20.10. Interest.....	160
Section 20.11. Inurement and Binding Effect.....	160
Section 20.12. No Partnership or Third Party Beneficiaries.....	160
Section 20.13. Cumulative Remedies.....	160
Section 20.14. Counterparts; Electronic Execution.....	160
Section 20.15. Time of the Essence.....	160
ARTICLE 21 DESIGN AND CONSTRUCTION.....	161
Section 21.1. General Duties.....	161
Section 21.2. Performance of D&C Work.....	161
Section 21.3. Design Development and Construction Commencement.....	161
Section 21.4. Suspension of Construction Work.....	162
Section 21.5. Removal of IMP Contractor.....	162
Section 21.6. Performance and Payment Security.....	163
ARTICLE 22 NOTICES TO PROCEED; IMP SUBSTANTIAL COMPLETION; IMP FINAL ACCEPTANCE.....	164
Section 22.1. Notices to Proceed.....	164
Section 22.2. IMP Substantial Completion.....	165
Section 22.3. IMP Final Acceptance.....	167
Section 22.4. Liquidated Damages for Failure to Achieve IMP Substantial Completion or IMP Final Acceptance.....	168

TABLE OF CONTENTS

(continued)

SCHEDULES

Schedule 1	Reserved
Schedule 2A	Performance Standards
Schedule 2B	Interim Performance Standards
Schedule 3A	Utility Facilities, Utility System Land; and Utility System Assets
Schedule 3B	Building Mechanical Systems
Schedule 3C	Distribution System
Schedule 4A	University Utility System Employees
Schedule 4B	Form of Employee Services Agreement
Schedule 5	Utility Fee
Schedule 6	Existing Supply Contracts
Schedule 7	Preliminary Design
Schedule 8A	Form of Legal Opinion of Counsel to UMLLC
Schedule 8B	Form of Legal Opinion of Counsel to the Concessionaire
Schedule 9	Historical Financial Information
Schedule 10	Permitted UMLLC Encumbrances
Schedule 11	Excluded Utility System Projects
Schedule 12	Computer Systems and Software
Schedule 13	Form of Memorandum of Sub-Lease
Schedule 14	Reserved
Schedule 15	Key Performance Indicators
Schedule 16	University Campus Map
Schedule 17	Diversity Plan
Schedule 18	Campus-Wide Permits
Schedule 19	Reserved
Schedule 20	Form of Trademark License Agreement
Schedule 21	Notices to Proceed; Conditions to IMP Substantial Completion and IMP Final Acceptance of Initial Modernization Project
Schedule 22	Warranty Period Utility System Projects
Schedule 23	University Lease

LONG-TERM SUB-LEASE AND CONCESSION AGREEMENT FOR LOUISIANA STATE UNIVERSITY UTILITY SYSTEM

THIS LONG-TERM SUB-LEASE AND CONCESSION AGREEMENT FOR THE LOUISIANA STATE UNIVERSITY UTILITY SYSTEM (this “Agreement”) is made and entered into as of this [•] day of [•], 2021, by and between Utilities Modernization LLC, a Louisiana limited liability company (“UMLLC”), the sole member of which is the LSU Real Estate and Facilities Foundation, a Louisiana nonprofit corporation (the “Foundation”), and [Baton Rouge Energy Concessionaire LLC, a [•] limited liability company (the “Concessionaire”)].

RECITALS

WHEREAS, Louisiana State University and Agricultural and Mechanical College (“LSU”) is the flagship institution of the State of Louisiana under the management and supervision of the Board of Supervisors of Louisiana State University and Agricultural and Mechanical College (the “Board” and, together with LSU, the “University”), which Board is a public constitutional corporation organized and existing under the laws of the State of Louisiana; and

WHEREAS, the Foundation is a tax-exempt organization organized and operated for the purpose of supporting the University, its programs, facilities, and research and educational activities, the Foundation is the sole member of UMLLC, and the business of UMLLC is at all times carried out and operated exclusively for the tax-exempt purposes of the Foundation; and

WHEREAS, the Concessionaire is a limited liability company organized and existing under the laws of the State of [•], registered and in good standing to conduct business in the State of Louisiana, and a leading core-competency U.S. district energy provider providing innovative, sustainable energy solutions across the United States, including but not limited to the operation of intelligent thermal energy systems that generate, store, and share energy; and

WHEREAS, at the University’s flagship campus in Baton Rouge, Louisiana (the “University Campus”), the operating costs, deferred maintenance and replacement of its Utility System (defined herein) comprised of the Utility Facilities and the Utility System Assets (both, as defined herein) places a substantial financial burden on the University and the State of Louisiana and exposes the University, State of Louisiana, and Utility System to risks that materially and adversely impact the University’s ability to conduct its business and satisfy its commitments and obligations; and

WHEREAS, the University has identified a need to develop and implement a comprehensive modernization, operations and maintenance solution for the Utility System in order to mitigate these risks, eliminate unnecessary expenditures, increase efficiencies that derive savings, establish robust levels of service for operations and maintenance, increase future budget certainty for the University, address deferred maintenance challenges, address the University’s anticipated increase in energy demand, achieve operational efficiencies, and ensure resiliency of the Utility System (the “Utilities Modernization Initiative”); and

WHEREAS, in light of these goals, the University, together with its staff and advisors, has undertaken a comprehensive review and assessment of the Utility System and has developed a framework for achieving the Utilities Modernization Initiative with one or more private district

energy services providers to make capital investments in and operate more efficiently the Utility System; and

WHEREAS, the University, UMLLC, the Concessionaire, and Tiger Energy Partners, LLC, a limited liability company organized and existing under the laws of the State of Delaware and authorized to do business in the State of Louisiana (“TEP”), have entered into that certain Cooperative Endeavor Agreement (LSU Utilities Modernization Initiative), dated the date hereof (the “UMI CEA”), to memorialize the cooperative intent among the University, UMLLC, the Concessionaire, and TEP to design, develop and implement improvements to the Utility System, and to establish generally the transaction framework for the implementation of the Utilities Modernization Initiative; and

WHEREAS, pursuant to Louisiana Revised Statutes 17:3361, *et seq.*, as amended from time to time (the “University Leasing Act”), the University is authorized to lease to a private entity, such as UMLLC, any portion or portions of the University Campus or other immovable property under its supervision and management under the conditions set forth therein; and

WHEREAS, the University Leasing Act further requires any such lease to a private entity to provide for the construction of improvements on the portion or portions of the University Campus subject to such lease that will further the educational, scientific, research, or public service functions of the University; and

WHEREAS, in furtherance of the foregoing, and pursuant to the UMI CEA, the University, UMLLC, the Concessionaire, and TEP are engaging in a public-private partnership for the performance of the Utilities Modernization Initiative, pursuant to which: (a) the University and UMLLC will enter into that certain Long-Term Lease and Concession Agreement for Louisiana State University Utility System dated the date hereof (the “University Lease”), for the lease of the Utility System Land, Utility Facilities and Utility System Assets (collectively, the “Property”), as more particularly described in Schedule 3A attached hereto, together with certain construction, access, parking, and utility servitudes for the purpose of implementing the Utilities Modernization Initiative, as approved by the University; (b) UMLLC will sublease the Property and grant the necessary construction, access, parking, and utility servitudes to the Concessionaire pursuant to this Agreement; and (c) the Concessionaire will engage TEP, as design-build contractor, to perform certain design and construction obligations related to the Initial Modernization Project pursuant to the Drop-Down DB Contract, which Drop-Down DB Contract has been approved by the University and UMLLC; and

WHEREAS, UMLLC has determined that the engagement of the Concessionaire under this Agreement will, among other things, further its energy efficiency and sustainability goals, provide a mechanism for capital improvements as needed, permit the more efficient operation of the Utility System, and advance the overall educational purposes of the University and UMLLC, and, therefore, desires to sublease the Property to the Concessionaire and provide the Concessionaire with an exclusive right to design, build, and finance the Initial Modernization Project and other Capital Improvements, and to operate, maintain, possess, control and improve the Utility System for the Term of this Agreement, all as hereinafter provided; and

WHEREAS, the Concessionaire agrees to sublease the Property from UMLLC and receive the exclusive grant from UMLLC to design, build, and finance the Initial Modernization Project and other Capital Improvements and to operate, maintain, possess, control, and improve the Utility System for the Term of this Agreement, all as hereinafter provided; and

WHEREAS, the Concessionaire agrees to sublease the Property from UMLLC and to operate, maintain, possess, control, and improve the Utility System in accordance with the provisions of this Agreement, including the Performance Standards (as defined herein); and

WHEREAS, the Concessionaire agrees to design, build, and finance the Initial Modernization Project and other Capital Improvements, as hereinafter provided; and

WHEREAS, the Concessionaire agrees to provide the Utility Services (as defined herein) to UMLLC and to engage in the Utility System Operations (as defined herein) pursuant to the terms and conditions of this Agreement;

NOW THEREFORE, for and in consideration of the promises, the mutual covenants, representations, warranties and agreements contained herein and other valuable consideration, the receipt and sufficiency of which are hereby acknowledged, the Parties (as defined herein) covenant and agree as follows:

ARTICLE 1 DEFINITIONS AND INTERPRETATION

Section 1.1. Definitions. Unless otherwise specified or the context otherwise requires, for the purposes of this Agreement the following terms have the following meanings:

“AA-Compensation” has the meaning ascribed thereto in Section 14.1(b).

“AA-Dispute Notice” has the meaning ascribed thereto in Section 14.1(c).

“AA-Notice” has the meaning ascribed thereto in Section 14.1(c).

“AA-Preliminary Notice” has the meaning ascribed thereto in Section 14.1(c).

“AAA” means the American Arbitration Association.

“Abandon” means to abandon all or a material part of the Initial Modernization Project, which abandonment will be deemed to have occurred if: (a) the Concessionaire demonstrates through statements, acts, or omissions an intent not to continue (for any reason other than a Delay Event that interferes with the Concessionaire’s ability to continue) to design or construct the Initial Modernization Project; (b) no significant Construction Work (taking into account any Delay Event) on the Initial Modernization Project is performed for a continuous period of more than sixty (60) days; or (c) the Concessionaire fails to begin (taking into account any Delay Event) (i) any works or activities authorized pursuant to NTP1 within thirty (30) days following the issuance of NTP1, (ii) any works or activities authorized pursuant to NTP2 within thirty (30) days following the issuance of NTP2, or (iii) any works or activities authorized pursuant to NTP3 within thirty

(30) days following the issuance of NTP3, in the case of each of clause (a), clause (b) and clause (c), unless such failure is otherwise expressly permitted or excused pursuant to this Agreement.

“Actual Knowledge of UMLLC” means the actual, current knowledge of the University’s [Note: *Designated Officer(s) of the University to be named*] on any date which a relevant representation or warranty is made, with the duty for each of the foregoing to inquire of his or her direct reports within five (5) Business Days prior to the date of such representation or warranty regarding the relevant matter, but without any other duty of inquiry or investigation; *provided, however,* that to the extent UMLLC makes any representation herein with respect to (i) the University, or (ii) the condition or prior operation of the Property or the Utility System, such representation is made by UMLLC without independent investigation and solely in reliance upon corresponding representations made by the University to UMLLC contained in the University Lease.

“Additional Coverages” has the meaning ascribed thereto in Section 13.3(m).

“Adjusted for Inflation” means adjusted by the arithmetic average of the percentage increases, if any, or decreases, if any, in the CPI Index during the most recent adjustment period as specified herein.

“Adverse Action” has the meaning ascribed thereto in Section 14.1(a).

“Affiliate”, when used to indicate a relationship with a specified Person, means:

- (a) a Person that, directly or indirectly, through one or more intermediaries (i) has a fifty percent (50%) or more voting or economic interest in such specified Person or (ii) is Controlled by such specified Person;
- (b) with respect to any Person described in clause (a), such Person’s Ultimate Holding Entity and any entity that such Ultimate Holding Entity (i) has a fifty percent (50%) or more voting or economic interest in or (ii) Controls;
- (c) any Person that is managed by either such Person described in clause (b) or a related body corporate of such Person for so long as such other Person is so managed;
- (d) any trustee of a trust in which all or substantially all of the beneficial interests are held directly or indirectly by such Person or any Person referred to in clauses (a), (b), or (c) of this definition; or
- (e) any trustee, custodian, or nominee of such Person or any Person referred to in clauses (a), (b), (c), or (d) of this definition;

provided that a Person shall be deemed to be controlled by another Person if controlled in any manner whatsoever that results in control in fact by that other Person (or that other Person and any Person or Persons with whom that other Person is acting jointly or in concert), whether directly or indirectly and whether through share ownership, a trust, a contract, or otherwise (for purposes of this definition, a managed fund or trust shall be deemed to be an Affiliate of the Person managing, supervising, sponsoring, or advising

such fund or trust and a limited partner in a managed fund or trust shall be deemed to be an Affiliate of such fund or trust and of the Person managing, supervising, sponsoring, or advising such fund or trust).

“Agreement” has the meaning ascribed thereto in the preamble hereto (including all Schedules referred to herein), as amended from time to time in accordance with the terms hereof.

“Approved Five-Year Plan” means the Five-Year Plan then in effect pursuant to Section 7.2.

“Approval”, “Approved”, “Approves”, “Approved by UMLLC” and similar expressions mean approved or consented to by UMLLC in accordance with the provisions of Section 1.15.

“Assignment and Assumption Agreement” has the meaning ascribed thereto in Section 19.8(c).

“Assumed Liabilities” has the meaning ascribed thereto in Section 3.2(d).

“Audit and Review” and similar expressions mean, with respect to any matter or thing relating to the D&C Work, the Utility System, the Utility System Operations or this Agreement, the performance by or on behalf of UMLLC of such reviews, investigations, inspections and audits relating to such matter or thing as UMLLC may reasonably determine to be necessary in the circumstances, conducted in each case in accordance with Prudent Industry Practices, if any, or as required by Law, and in accordance with the provisions of this Agreement.

“Authorization” means any approval, certificate of approval, certification, authorization, consent, waiver, variance, exemption, declaratory order, exception, license, filing, registration, permit, franchise, notarization, or other requirement of any Person that applies to the Utility System or is reasonably required from time to time for the Utility System Operations, including any of the foregoing issued, granted, given, or otherwise made available by or under the authority of any Governmental Authority or pursuant to any applicable Law.

“Bank Rate” means three (3) -month LIBOR (or any successor rate thereto) as reported in the *Wall Street Journal* (or any successor thereof).

“Board” has the meaning ascribed thereto in the recitals of this Agreement.

“Breakage Costs” means any breakage costs, make-whole premium payments, termination payments, or other prepayment amounts (including debt premiums and interest rate hedge termination costs) that are required to be paid by the Concessionaire with respect to Leasehold Mortgage Debt as a result of the early repayment (including, following acceleration) of such Leasehold Mortgage Debt prior to its scheduled maturity date.

“Building Mechanical Systems” means those “in-building” portions of the Utility Facilities more particularly described in Schedule 3B.

“Business Day” means any Day that is neither a Saturday, a Sunday, nor a Day observed as a holiday by the University; *provided*, that solely with respect to the timing of any payment

obligation under this Agreement, a Business Day shall also not be a Day on which banks that are members of the United States federal reserve system are permitted or required to be closed.

“Campus-Wide Permits” means the Authorizations set forth on Schedule 18, as each may be extended, renewed, modified, or replaced.

“Capital Improvement” means any improvement to or replacement or expansion of the components of the Utility Facilities or Shared Spaces that is capital in nature, as determined in accordance with GAAP. For clarity, the Initial Modernization Project constitutes a Capital Improvement.

“Capital Recovery Amount” has the meaning ascribed thereto in Schedule 5.

“Capped O&M Amount” has the meaning ascribed thereto in Schedule 5.

“Casualty Cost” has the meaning ascribed thereto in Section 13.4(a)(ii).

“CenTrio” means [●].

“Certificate of IMP Final Acceptance” has the meaning ascribed thereto in Section 22.1(g).

“Certificate of IMP Substantial Completion” has the meaning ascribed thereto in Section 22.2(e).

“Change in Control” means, with respect to any Person, whether accomplished through a single transaction or a series of related or unrelated transactions and whether accomplished directly or indirectly, any of (i) a change in ownership so that fifty percent (50%) or more of the direct or indirect voting or economic interests in such Person is transferred to a Person or group of Persons acting in concert, (ii) a change in the power directly or indirectly to direct or cause the direction of management and policy of such Person, whether through ownership of voting securities, by contract, management agreement, or common directors, officers or trustees or otherwise, is transferred to a Person or group of Persons acting in concert, or (iii) the merger, consolidation, amalgamation, business combination, or sale of substantially all of the assets of such Person; *provided, however*, that notwithstanding anything to the contrary set forth in this definition, none of the following shall constitute a Change in Control for the purposes of this Agreement:

- (a) Transfers of direct or indirect ownership interests in the Concessionaire between or among (i) Persons that are majority-owned Affiliates of each other or (ii) Persons that are under common Control, whether directly or indirectly and whether through share ownership, a trust, a contract or otherwise with each other or with the Ultimate Holding Entity of the Concessionaire;
- (b) Transfers of equity of the Concessionaire or of the direct or indirect owners of the Concessionaire pursuant to bona fide open market transactions on the New York Stock Exchange, NASDAQ, London Stock Exchange, Toronto Stock Exchange, or comparable U.S. or foreign securities exchange, including any such transactions involving an initial or “follow on” public offering of direct or indirect equity holders of the Concessionaire; *provided* that no Person (that is not an Equity

Participant or its beneficial owner having ownership interests in the Concessionaire as of the date hereof) or group of Persons acting in concert (that is not an Equity Participant or its beneficial owner having ownership interests in the Concessionaire as of the date hereof) acquires securities such that such Person or group of Persons beneficially owns more than fifty percent (50%) of the publicly traded securities of the Concessionaire;

- (c) Transfers of direct or indirect ownership interests in the Concessionaire by any Equity Participant or its beneficial owners to any Person so long as the Equity Participants or their respective beneficial owners having ownership interests in the Concessionaire as of the date hereof or any Affiliate of such Equity Participants together retain, in the aggregate, (1) fifty percent (50%) or more of the direct or indirect voting or economic interests in the Concessionaire or (2) the power to directly or indirectly direct or cause the direction of management and policy of the Concessionaire, whether through ownership of voting securities, contract or management agreement, or common directors, officers, or trustees or otherwise (for the avoidance of doubt, the issuance, redemption, or transfer of units, shares, or interests in the Equity Participant alone, without additional facts or circumstances, will not itself constitute a Change in Control of the Concessionaire);
- (d) any change of ownership that is attributable to a lease, sublease, concession, management agreement, operating agreement, or other similar arrangement that is subject and subordinate in all respects to the rights of UMLLC under this Agreement so long as (1) no Change in Control occurs with respect to the Concessionaire, and (2) the Concessionaire remains obligated under this Agreement;
- (e) the creation of a trust or any other transaction or arrangement that is solely a transfer of all or part of the Concessionaire's economic interest under this Agreement to another entity so long as (1) no Change in Control occurs with respect to the Concessionaire, and (2) the Concessionaire remains obligated under this Agreement;
- (f) Transfers of direct or indirect ownership interests in the Concessionaire (1) between or among investment funds, including funds that invest in infrastructure, and investors therein; *provided* that, following such Transfer, such direct or indirect ownership interests (A) remain under the same common ownership, management, or control as existed prior to such Transfer or (B) are under the common ownership, management, or Control of the Ultimate Holding Entity of the Concessionaire, or (2) from investment funds, including infrastructure funds, or investors therein, to any Person; *provided* that such direct or indirect ownership interests, following the consummation of such Transfer, (x) remain under the same management or Control that existed prior to such Transfer or (y) are under the common ownership, management, or Control of the Ultimate Holding Entity of the Concessionaire; it being understood that ownership interests shall be deemed to be Controlled by a Person if controlled in any manner whatsoever that results in Control in fact,

whether directly or indirectly, and whether through share ownership, a trust, a contract, or otherwise;

- (g) Transfers of direct or indirect ownership interests in the Concessionaire to any Person that is a trustee, custodian, or nominee of (i) any Person who was the beneficial owner of such direct or indirect ownership interests in the Concessionaire immediately prior to such Transfer or (ii) any Person otherwise permitted to be a transferee without causing a Change in Control of the Concessionaire pursuant to this definition, provided that such direct or indirect ownership interest, following consummation of such Transfer, (x) remain under the same management or Control that existed prior to such Transfer or (y) are under the common ownership, management, or Control of the Ultimate Holding Entity of the Concessionaire or an Affiliate of the Ultimate Holding Entity of the Concessionaire; it being understood that ownership interests shall be deemed to be Controlled by a Person if Controlled in any manner whatsoever that results in Control in fact, whether directly or indirectly, and whether through share ownership, a trust, a contract, or otherwise; and
- (h) Mergers between an Equity Participant and a third party, provided that, immediately prior to such merger, the equity interests of both parties are publicly traded in open market transactions on the New York Stock Exchange, NASDAQ, London Stock Exchange, Toronto Stock Exchange, or comparable U.S. or foreign securities exchange.

“CI Cost of Debt Factor” has the meaning ascribed thereto in Schedule 5.

“CI Return on Equity Factor” has the meaning ascribed thereto in Schedule 5.

“City-Parish” means the City of Baton Rouge and Parish of East Baton Rouge, State of Louisiana.

“Claim” means any demand, action, cause of action, suit, proceeding, arbitration, claim, judgment, or settlement or compromise relating thereto which may give rise to a right to a payment obligation under Section 12.1 or Section 12.2.

“Code” means the Internal Revenue Code of 1986, as amended from time to time. Any reference in this Agreement to a particular provision of the Code shall be interpreted to include a reference to any corresponding provision of any successor statutes.

“Cogeneration Building” means the “Cogeneration Building” as described or depicted Schedule 3A.

“Comparable Utility Systems” means with respect to any component of the Utility System, a utility system producing and/or delivering any of the Utilities (whether privately or publicly owned) that is located at a large university, is used in connection with providing such utility services to such university, its employees, customers, and visitors and is reasonably comparable to the relevant component of the Utility System in terms of physical structure, capacity, condition,

utilization, and the nature of the services provided, provided that UMLLC and the Concessionaire may designate by written agreement one or more utility systems as “Comparable Utility Systems”.

“Compensation Calculation Date” means each of the following: (i) each June 30 during the Term, commencing as of June 30, 202[●]; (ii) the date of removal of the Operator pursuant to Section 3.3(c)(ii); (iii) the first (1st) June 30 after any date on which one Party notifies the other Party that it, in good faith, believes that the Concession and KPI Compensation Balance would exceed [two hundred fifty thousand dollars (\$250,000)] if calculated on the date of such notice; and (iv) the End Date.

“Compensation Calculation Measuring Period” means (i) with respect to the first (1st) Compensation Calculation Date, the period commencing on the Turnover Date and expiring on such Compensation Calculation Date, and (ii) with respect to each subsequent Compensation Calculation Date, the period between such Compensation Calculation Date and the immediately preceding Compensation Calculation Date.

“Compensation Event” means each of the following: (i) subject to Article 5, the Concessionaire’s compliance with or the implementation of any UMLLC Directive or any modified or changed Performance Standard, subject to Section 6.3(b); *provided* that it shall not be a Compensation Event if the costs or reduction in revenue incurred in connection therewith will be recovered by the Concessionaire pursuant to the calculation and payment of the Utility Fee; (ii) the occurrence of an Adverse Action; (iii) the occurrence of an event causing a delay described in the definition of “Delay Event” but only to the extent that the Utility Fee is reduced by a Delay Event caused by such event pursuant to Section 15.1(c); (iv) the occurrence of an event expressly described as a Compensation Event in Section 3.7(a); (v) UMLLC distributing or permitting any third party to distribute on the University Campus, any Utility, except as permitted by Section 3.21; (vi) the Concessionaire incurring any Losses as a result of failing to obtain, or being unreasonably delayed in obtaining, or failing to promptly renew or maintain in good standing, an Authorization from UMLLC that is necessary to comply with Law, despite the Concessionaire’s use of its reasonable best efforts to obtain, promptly renew, or maintain in good standing such Authorization, and such failure or delay could not have been reasonably prevented by commercially reasonable technical, scheduling, or other measures of the Concessionaire; (vii) any suspension of the Construction Work that constitutes a Compensation Event pursuant to Section 21.4(b); (viii) any action of the Louisiana Public Service Commission or the Federal Energy Regulatory Commission, or their respective successors, that subjects the Concessionaire to such agency’s regulatory jurisdiction due solely to the Utility System Operations performed by the Concessionaire in accordance with this Agreement and has a material adverse effect on the fair market value of the Concessionaire Interest (whether as a result of a decrease in the Utility Fee or other revenues or increased expenses that cannot be recovered pursuant to this Agreement or both), except where such action is in response to any act or omission on the part of the Concessionaire that is illegal (other than an act or omission rendered illegal by virtue of the agency’s action) or such action is otherwise permitted under this Agreement and such designation as a Compensation Event shall be the Concessionaire’s sole right and remedy with respect to any action by the Louisiana Public Service Commission or the Federal Energy Regulatory Commission (or their successors) subjecting a Person to its jurisdiction in connection with the Utility System; (ix) the occurrence of a change described in clause (iii) of Section 6.1(a) to the extent that notice of such change was not publically available or otherwise known by CenTrio prior to the date hereof; or (x)

the occurrence of any other event that under the terms of this Agreement expressly requires the payment of Concession Compensation.

“Concession Compensation” means any amount payable by UMLLC to the Concessionaire in order to restore the Concessionaire to the same economic position the Concessionaire would have enjoyed if the applicable Compensation Event had not occurred, which amount, for any Compensation Calculation Date, shall be calculated as the sum of (i) all Losses for the applicable Compensation Calculation Measuring Period and financing costs (but excluding any costs and expenses that the Concessionaire is able to recover through the payment of the Utility Fee) plus (ii) the actual and estimated net losses of the Utility Fee for the applicable Compensation Calculation Measuring Period that is reasonably attributable to such Compensation Event; *provided, however*, that with respect to clause (ii), the amount of such actual and estimated net losses that may be claimed at any Compensation Calculation Date shall not exceed the amount of actual and estimated net losses of the Utility Fee suffered during, and attributable only to, such Compensation Calculation Measuring Period (including the inability to make Capital Improvements that UMLLC had Approved); *provided, further*, that with respect to clause (ii), the amount of such actual and estimated net losses reasonably attributable to such Compensation Event and suffered during, and attributable only to, a future Compensation Calculation Measuring Period may be claimed as Concession Compensation for such future Compensation Calculation Measuring Period only during such future Compensation Calculation Measuring Period in accordance with Article 15. Concession Compensation, if any, shall be paid in accordance with Article 15 and shall not be subject to any limitations on the amount of the Utility Fee. If the Concessionaire provides its own capital for a Capital Improvement with respect to compliance with any Compensation Event that is not recoverable by the Concessionaire pursuant to the Utility Fee, then the Concession Compensation, shall, in addition to the components described above, take into account a return on such capital equal to the IMP Return on Equity Factor or the CI Return on Equity Factor, as the case may be.

“Concession and KPI Compensation Balance” means, at each Compensation Calculation Date, (i) Concession Compensation due and payable with respect to such Compensation Calculation Measuring Period pursuant to the terms of this Agreement less (ii) the sum of all KPI Compensation due and payable with respect to such Compensation Calculation Measuring Period pursuant to the terms of this Agreement, plus (iii) the Concession and KPI Compensation Balance (which may be negative) for the preceding Compensation Calculation Measuring Period if carried forward pursuant to Section 15.3(e).

“Concessionaire” has the meaning ascribed thereto in the preamble to this Agreement.

“Concessionaire Cost of Finance” means an amount equal to eight hundred forty thousand dollars (\$840,000) from the gross amount of the Concessionaire’s financing of the Initial Modernization Project.

“Concessionaire Default” has the meaning ascribed thereto in Section 16.1(a).

“Concessionaire Interest” means the interest of the Concessionaire in the Utility System created by this Agreement and the rights and obligations of the Concessionaire under this Agreement.

“Concessionaire Parent” means the Person, if any, that owns, and only owns, one hundred percent (100%) of the shares of the capital stock, units, partnership or membership interests, other equity interests and equity securities, to the extent applicable, of the Concessionaire.

“Concessionaire Required Coverages” has the meaning ascribed thereto in Section 13.1.

“Concessionaire Utility System Employees” means those Persons employed by the Concessionaire immediately prior to the End Date whose duties directly relate to the provision of the Utility Services.

“Consent” means any approval, consent, ratification, waiver, exemption, franchise, license, permit, novation, certificate of occupancy, or other authorization of any Person, including any Consent issued, granted, given, or otherwise made available by or under the authority of any Governmental Authority or pursuant to any applicable Law.

“Contractor” means, with respect to a Person, any contractor with whom such Person contracts to perform work or supply materials or labor in relation to the Utility System, including any subcontractor of any tier, supplier, or materialman directly or indirectly employed pursuant to a subcontract with a Contractor. For the avoidance of doubt, each of the Operator (if other than the Concessionaire) and the IMP Contractor shall be a Contractor of the Concessionaire.

“Construction Documents” means all shop drawings, working drawings, fabrication plans, material and hardware descriptions, specifications, construction quality control reports, and construction quality assurance reports and samples necessary or desirable for construction of the Initial Modernization Project in accordance with this Agreement.

“Construction Work” means all work to build or construct, make, form, manufacture, furnish, install, supply, deliver, or equip the Initial Modernization Project.

“Control” means, when used with respect to any particular Person, the possession, directly or indirectly, of the power to direct or cause the direction of the management and policies of such Person whether through the ownership of voting securities or partnership or other ownership interests, by contract or otherwise, and the terms “Controlling,” “Controlled by” and “under common Control with” have meanings correlative to the foregoing. With respect to a managed fund or trust, Control includes the right to direct or cause the direction of the management and policies of such managed fund or trust as manager, advisor, supervisor, sponsor, or trustee pursuant to relevant contractual arrangements.

“CPI Index” means the “Consumer Price Index – South Urban, All Items” (not seasonally adjusted) as published by the U.S. Department of Labor, Bureau of Labor Statistics; *provided, however*, that if the CPI Index is changed so that the base year of the CPI Index changes, the CPI Index shall be converted in accordance with the conversion factor published by the U.S. Department of Labor, Bureau of Labor Statistics; *provided further*, that if the CPI Index is discontinued or revised during the Term, such other index or computation with which it is replaced shall be used in order to obtain substantially the same result as would be obtained if the CPI Index had not been discontinued or revised.

“Credit Rating Agencies” means Standard & Poor’s Rating Services, Fitch Investors Service, Inc., or Moody’s Investor Services, or their successors or Affiliates, provided that if any of the foregoing and any of their successors cease to exist, UMLLC shall, by written notice to the Concessionaire, identify other credit rating agencies as the “Credit Rating Agencies” that, at such time, are Nationally Recognized Statistical Rating Organizations as determined and defined by the United States Securities and Exchange Commission or their equivalents.

“D&C Closeout Plan” has the meaning ascribed thereto in Section 22.2(b).

“D&C Security” means, collectively, (i) the Performance Bond and (ii) the Payment Bond.

“D&C Work” means all design, engineering, and construction-related services, including the Construction Work, necessary in order to design, implement, and deliver the Initial Modernization Solution in accordance with the approved Final Design and the terms and conditions of this Agreement, including Article 22 and Article 23.

“Day” means a calendar day, beginning at midnight in the central time zone of the United States coinciding with the calendar day.

“Defending Party” has the meaning ascribed thereto in Section 12.4(c).

“Delay Event” means: (i) an event of Force Majeure that interrupts, limits, or otherwise adversely affects the performance of the Concessionaire’s obligations hereunder or the Concessionaire’s use of all or any material part of the Utility System; (ii) a failure to obtain, or delay in obtaining, any Authorization from a Governmental Authority (provided that such failure or delay could not have been reasonably prevented by technical and scheduling measures or other reasonable measures of the Concessionaire); (iii) the enactment of a new Law or the modification, amendment, or change in enforcement or interpretation of a Law (including a change in the application or implementation thereof by any Governmental Authority) arising after the Turnover Date; (iv) a delay caused by the performance of works (including the activities authorized by Section 3.7) carried out by UMLLC or at its direction or, for purposes of Delay Events only (and not Compensation Events), by any other Person not acting under the authority or direction of the Concessionaire or any Contractor; (v) a delay caused by a failure by UMLLC to perform or observe any of its covenants or obligations under this Agreement; (vi) a delay caused by the presence in, on, under, over, or around the Utility System of Hazardous Substances, which, in each case, results in or would result in a delay or interruption in the performance by the Concessionaire of any obligation under this Agreement and which Hazardous Substances were not caused to be in, on, under, over, or around the Utility System by the Concessionaire, any Contractor, or any of their respective Representatives; (vii) a delay in providing the Utility Services caused by the failure of a third party or UMLLC to provide any of the inputs into the Utility System that would be included in the definition of “Supplies”; (viii) subject to Section 9.4(a), a delay caused by a breach by UMLLC of its representations and warranties set forth herein; (ix) a writ, decree, or injunction that precludes or prevents the performance of the Concessionaire’s obligations hereunder or the Concessionaire’s use of all or any material part of the Utility System; (x) the discovery at or about the site of construction required or permitted to be undertaken pursuant to this Agreement of legally protected plant or animal species or archaeological, paleontological, or cultural resources; or (xi) the occurrence of any event expressly described as a Compensation Event in clause (i),

clause (vii), or clause (viii) of the definition of “Compensation Event.” For the avoidance of doubt, a Delay Event shall not include any event of which the consequence is otherwise specifically dealt with in this Agreement or arises by reason of (A) the negligence or willful misconduct of, or violation of applicable Law by, the Concessionaire, any Contractor, or any of their respective Representatives, (B) any act or omission by the Concessionaire or its Representatives in breach of the provisions of this Agreement, (C) any strike, labor dispute, or other labor protest involving any Person retained, employed, or hired by the Concessionaire or its Representatives to supply materials or services for or in connection with the Utility System Operations or any strike, labor dispute, or labor protest pertaining to the Concessionaire, in all cases to the extent that such strike, dispute, or protest (1) is not of general application and (2) is caused by or attributable to any act (including any pricing or other practice or method of operation) or omission of the Concessionaire or its Representatives, or (D) lack or insufficiency of funds or failure to make payment of monies or provide required security on the part of the Concessionaire, unless such lack or insufficiency of funds or such failure is caused by another relevant Delay Event.

“Delay Event Remedy” has the meaning ascribed thereto in Section 15.1(d).

“Delay Event Remedy Dispute Notice” has the meaning ascribed thereto in Section 15.1(e).

“Delay Event Remedy Notice” has the meaning ascribed thereto in Section 15.1(e).

“Depository” means a savings bank, a savings and loan association, or a commercial bank or trust company which would qualify as an Institutional Lender, designated by the Concessionaire, that enters into an agreement with the Concessionaire to serve as depository pursuant to this Agreement, provided that such Depository shall have an office, branch, agency, or representative located in the City of Baton Rouge, Louisiana (or in another location within the United States designated by UMLLC in writing, acting reasonably); *provided, however*, that so long as a Leasehold Mortgage is in effect, the Depository under Section 13.4 shall be the institution acting as the collateral agent or depository under the financing secured by such Leasehold Mortgage, whether or not it has an office, branch, agency, or representative located in the City of Baton Rouge, Louisiana (or such other location within the United States designated by UMLLC in writing, acting reasonably).

“DEQ” has the meaning ascribed thereto in Section 11.13.

“Designated Senior Person” means such individual or individuals who are designated as such from time to time by each Party for the purposes of Article 18 by written notice to the other Party, which may be changed at any time by written notice from such Party to the other Party. Initially, the Designated Senior Person for UMLLC will be UMLLC’s [•] and the Designated Senior Persons for the Concessionaire will be [•] and [•].

“Direct Claim” means any Claim by an Obligee against an Obligor that does not result from a Third Party Claim.

“Disclosure Schedules” means the following Schedules: Schedule 3A, Schedule 3B, Schedule 6, Schedule 9, Schedule 10, Schedule 11, Schedule 12, Schedule 14, Schedule 16, Schedule 18, and Schedule 22.

“Dispute Notice” has the meaning ascribed thereto in Section 15.3(b).

“Distribution Bottlenecks” means those portions of the Distribution System described on Schedule 3C which are subject to the Initial Modernization Project as described on Schedule 7 and which portions, for purposes of this Agreement, (i) shall be deemed a part of the Utility System (and not part of the Distribution System) until the IMP Substantial Completion Date, and (ii) shall be deemed a part of the Distribution System (and not part of the Utility System, unless and until the same becomes subject to a Distribution System Capital Improvement) from and after the IMP Substantial Completion Date.

“Distribution System” means the respective equipment, systems and facilities (including any discrete component portion thereof) for the carriage and distribution of each Utility that are, as of the Turnover Date, beyond the line of demarcation for inclusion in the Utility Facilities and Utility System, all as described and shown on Exhibit 3C.

“Distribution System Capital Improvement” means any improvement to or replacement or expansion of the components of the Distribution System that is capital in nature, as determined in accordance with GAAP.

“Diverse Business” has the meaning ascribed thereto in Section 11.11.

“Diversity Plan” means the Diversity, Inclusion and Equity Plan attached hereto as Schedule 17.

“Document” has the meaning ascribed thereto in Section 1.15(j).

“Drop-Down DB Contract” means that certain [•] dated as of the date hereof by and between the Concessionaire and the IMP Contractor, providing for the design, construction, and completion of the Initial Modernization Project.

“Eligible Investments” means any one or more of the following obligations or securities: (i) direct obligations of, and obligations fully guaranteed by, the United States of America or any agency or instrumentality of the United States of America, the obligations of which are backed by the full faith and credit of the United States of America; (ii) demand or time deposits, federal funds or bankers’ acceptances issued by any Institutional Lender (provided that the commercial paper or the short-term deposit rating or the long-term unsecured debt obligations or deposits of such Institutional Lender at the time of such investment or contractual commitment providing for such investment have been rated “A” (or the equivalent) or higher by a Credit Rating Agency or any other demand or time deposit or certificate of deposit fully insured by the Federal Deposit Insurance Corporation); (iii) commercial paper (including both non-interest-bearing discount obligations and interest-bearing obligations payable on demand or on a specified date not more than one (1) Year after the date of issuance thereof) which has been rated “A” (or the equivalent) or higher by a Credit Rating Agency at the time of such investment; (iv) any money market funds, the investments of which consist of cash and obligations fully guaranteed by the United States of America or any agency or instrumentality of the United States of America, the obligations of which are backed by the full faith and credit of the United States of America and which have been rated “A” (or the equivalent) or higher by a Credit Rating Agency; and (v) other investments then customarily accepted by UMLLC in similar circumstances; *provided, however*, that no instrument

or security shall be an Eligible Investment if such instrument or security evidences a right to receive only interest payments with respect to the obligations underlying such instrument or if such instrument or security provides for payment of both principal and interest with a yield to maturity in excess of one hundred twenty percent (120%) of the yield to maturity at par.

“Emergency” means (i) an Unplanned Outage or (ii) a situation that is urgent and calls for immediate action, which, if such action is not taken, is reasonably likely to result in imminent harm or physical damage to any or all of the Utility System or any Person, including UMLLC or the Concessionaire.

“Employee Services Agreement” means the agreement set forth in the form of Schedule 4B.

“Encumbrance” means any mortgage, lien, judgment, execution, pledge, charge, security interest, restriction, easement, servitude, option, reservation, lease, claim, trust, deemed trust, or encumbrance of any nature whatsoever, whether arising by operation of Law, judicial process, contract, agreement, or otherwise created.

“End Date” means the date on which this Agreement expires or is terminated.

“Environment” means soil, surface waters, ground waters, land, stream sediments, surface or subsurface strata, and ambient air.

“Environmental Laws” means any Laws applicable to the Utility System or Utility System Operations regulating or imposing liability or standards of conduct concerning or relating to (i) the regulation, use, or protection of human health or the Environment or (ii) the presence of or regulation, use, or exposure to Hazardous Substances.

“Equity Participant” means any Person who holds directly any shares of capital stock, units, partnership or membership interests, other equity interests, or equity securities of the Concessionaire.

“Equivalent Project Relief” has the meaning ascribed thereto in Section 1.21.

“Excluded Liabilities” has the meaning ascribed thereto in Section 3.2(d).

“Excluded Utility System Projects” means (a) those projects that either UMLLC or the University is undertaking with respect to the Utility System that are listed on Schedule 11 and (b) those Capital Improvements that either UMLLC or the University undertakes after the Turnover Date pursuant to its right to undertake such improvements under Section 3.21 or Section 4.1(b).

“Extraordinary Failure” means the failure (but only if such failure occurs prior to the Planned IMP Substantial Completion Date) of equipment or systems associated with the Utility System not addressed by the Initial Modernization Project reasonably attributable to the University’s deferred maintenance of the Utility System accumulated as of the Turnover Date, including end-of-life breakdown repairs, replacements and rentals of temporary replacement equipment.

“FA Punch List” means the itemized list of Construction Work that remains to be completed as a condition to IMP Final Acceptance, prepared by the Concessionaire and included in the D&C Closeout Plan and agreed with UMLLC prior to IMP Substantial Completion in accordance with Section 21.1. The FA Punch List shall only include any incomplete Construction Work that, due to its nature and the activities required to correct and complete the work, will not have any material or adverse effect on the normal, uninterrupted, and safe use of the Initial Modernization Project.

“Final Design” shall mean the full and complete design for the Initial Modernization Project, based on the Preliminary Design and approved by UMLLC and the University, for the final design and construction of one hundred percent (100%) of the Initial Modernization Project pursuant to the Drop-Down DB Contract.

“Fiscal Year” means the period from July 1 to June 30, provided that the Fiscal Year shall always be the same as the University’s fiscal year.

“Five-Year Plan” means the budget and plan prepared by the Concessionaire in accordance with Section 7.2 for the operation of the Utility System and performance of its obligations under this Agreement in respect of (i) the period consisting of the first partial Fiscal Year of the Term and the first five (5) full Fiscal Years of the Term, (ii) any given period of exactly five (5) full Fiscal Years during the Term, or (iii) if fewer than five (5) full Fiscal Years remain in the Term, the remaining full and partial Fiscal Years of the Term.

“Force Majeure” means any event beyond the reasonable control of a Party that delays, interrupts, or limits the performance of the affected Party’s obligations hereunder, including an intervening act of God or public enemy, war, invasion, armed conflict, act of foreign enemy, blockade, revolution, act of terror, sabotage, civil commotions, interference by civil or military authorities, condemnation or confiscation of property or equipment by any Governmental Authority, nuclear or other explosion, radioactive or chemical contamination or ionizing radiation, fire, tornado, flooding, earthquake or other natural disaster, riot or other public disorder, vandalism, epidemic, quarantine restriction, strike, labor dispute or other labor protest, stop-work order or injunction issued by a Governmental Authority, a governmental embargo, or general unavailability or interruption of supplies or products for the construction, operation, maintenance, repair, replacement, and renovation of the Utility System.

“Forecast Utility Fee” has the meaning ascribed thereto in Section 7.1(a).

“Foreign Shell Bank” means a foreign bank that does not have a physical presence in any country and that is not affiliated with a bank that has a physical presence and an acceptable level of regulation and supervision.

“Foundation” has the meaning ascribed thereto in the preamble to this Agreement.

“GAAP” means U.S. generally accepted accounting principles, consistently applied.

“Governmental Authority” means any court, federal, state, local, or foreign government, department, commission, board, bureau, agency, or other regulatory, administrative,

governmental, or quasi-governmental authority, which shall not include UMLLC or the University.

“Hazardous Substance” means any solid, liquid, gas, odor, heat, sound, vibration, radiation, or other substance or emission which is a contaminant, pollutant, dangerous substance, toxic substance, hazardous waste, subject waste, hazardous material, or hazardous substance that is or becomes regulated by applicable Environmental Laws or which is classified as hazardous or toxic under applicable Environmental Laws (including gasoline, diesel fuel or other petroleum hydrocarbons, polychlorinated biphenyls, asbestos, lead-based paint, and urea formaldehyde foam insulation).

“Highland Utility Center” means the “Highland Utility Center” as described or depicted Schedule 3A.

“IFRS” means the International Financial Reporting Standards, consistently applied.

“IMP Contractor” means, initially, TEP and, thereafter, any successor to TEP designated by the Concessionaire as the IMP Contractor pursuant Section 21.5.

“IMP Cost of Debt Factor” has the meaning ascribed thereto in Schedule 5.

“IMP Design Documents” means all drawings (including plans, profiles, cross-sections, notes, elevations, details, and diagrams), specifications, reports, studies, calculations, electronic files, records, and submittals necessary for, or related to, the design of the Initial Modernization Project. IMP Design Documents includes the Record Design Documents.

“IMP Final Acceptance” means the occurrence of all the events and satisfaction of all the conditions set out in Schedule 21, Part [C], as and when confirmed by UMLLC’s issuance of a certificate in accordance with the procedures and within the time frame set out in Section 22.2.

“IMP Final Acceptance Date” means the date upon which UMLLC issues the Certificate of IMP Final Acceptance.

“IMP Final Acceptance Deadline” means the day that is [sixty (60)] Days after the IMP Substantial Completion Date.

“IMP Final Acceptance Long Stop Date” means the day that is three hundred sixty-five (365) days after the Planned IMP Substantial Completion Date, as such period may be extended in accordance with Section 15.1(c).

“IMP Return on Equity Factor” has the meaning ascribed thereto in Schedule 5.

“IMP Substantial Completion” means (a) the satisfaction of all the conditions set out in Schedule 21, Part [B] and (b) issuance by UMLLC of the Certificate of IMP Substantial Completion in accordance Section 21.1.

“IMP Substantial Completion Date” means the date upon which UMLLC issues the Certificate of IMP Substantial Completion.

“IMP Substantial Completion Long Stop Date” means the day that is three hundred sixty-five (365) days after the Planned IMP Substantial Completion Date, as such period may be extended in accordance Section 15.1(c).

“Initial Five-Year Plan” means the Five-Year Plan in respect of the period set forth in clause (i) of the definition of “Five-Year Plan”.

“Initial Investor” means the Concessionaire Parent or, if there is no Concessionaire Parent as of the date hereof, each Equity Participant as of the date hereof.

“Initial Modernization Project” means the initial improvements and upgrades to the Utility System contemplated by the Preliminary Design and to be implemented and delivered by the Concessionaire in accordance with the Final Design and the terms and conditions set forth in this Agreement.

“Institutional Lender” means: (i) the United States of America, any state thereof, or any agency or instrumentality of either of them, any municipal agency, public benefit corporation or public authority, advancing or insuring mortgage loans or making payments which, in any manner, assist in the financing, development, operation, and maintenance of projects; (ii) any (a) savings bank, savings and loan association, commercial bank, trust company (whether acting individually or in a fiduciary capacity), or insurance company organized and existing under the laws of the United States of America or any state thereof, (b) foreign insurance company or commercial bank qualified to do business as an insurer or commercial bank as applicable under the laws of the United States of America, (c) pension fund, foundation or university or college or other endowment fund or (d) investment bank, pension advisory firm, mutual fund, investment company, or money management firm; (iii) any “qualified institutional buyer” under Rule 144(A) under the Securities Act or any other similar Law hereinafter enacted that defines a similar category of investors by substantially similar terms; or (iv) any other financial institution or entity designated by the Concessionaire and Approved by UMLLC (provided that such institution or entity, in its activity under this Agreement, shall be acceptable under then-current guidelines and practices of UMLLC); *provided, however*, that each such entity (other than entities described in clause (iii) of this definition) or combination of such entities if the Institutional Lender shall be a combination of such entities shall have individual or combined assets, as the case may be, of not less than five hundred million dollars (\$500,000,000), which shall include, in the case of an investment or advisory firm, assets controlled by it or under management.

“Interim Performance Standards” means the standards, specifications, policies, procedures, and processes that apply to the operation of, maintenance of, rehabilitation of the Utility System set forth in Schedule 2B and the appendices thereto (as may be modified pursuant to the terms hereof) from Turnover until the IMP Substantial Completion of the Initial Modernization Project. To the extent that any term or provision set forth in Schedule 2B or incorporated by reference in Schedule 2B conflicts with any term or provision specified in this Agreement, then such term or provision of this Agreement shall govern and shall supersede any such conflicting term or provision.

“Key Performance Indicators” means those requirements and standards for the operation of the Utility System as set forth on Schedule 15.

“KPI Compensation” means the amount of compensation due from the Concessionaire to UMLLC for a KPI Event, which amount for each KPI Event is set forth in Schedule 15.

“KPI Event” has the meaning set forth in Schedule 15, unless such KPI Event is due to a Delay Event, a Compensation Event, a breach of this Agreement by UMLLC, the negligence or willful misconduct of UMLLC or its Representatives, grantees, tenants, contractors, mortgagees, licensees, concessionaires, and others claiming by, through, or under UMLLC, or otherwise excused pursuant to this Agreement.

“Law” means any order, writ, injunction, decree, judgment, law, ordinance, decision, opinion, ruling, policy, statute, code, rule, or regulation of any Governmental Authority.

“Leasehold Mortgage” means any lease, indenture, mortgage, deed of trust, pledge, or other security agreement or arrangement, including a securitization transaction with respect to the Utility Fee or any part thereof, encumbering any or all of the Concessionaire Interest or the shares or equity interests in the capital of the Concessionaire and any of its subsidiaries or any cash reserves or deposits held in the name of the Concessionaire, in each case that satisfies all of the conditions set forth in Section 3.6 and Section 19.1.

“Leasehold Mortgage Debt” means: (i) any bona fide debt (including principal, accrued interest, original issue discount and customary lender or financial insurer, agent and trustee fees, costs, premiums, expenses, indemnities and reimbursement obligations (whether liquidated or contingent) with respect thereto, and including all payment obligations under interest rate hedging agreements with respect thereto and reimbursement obligations with respect thereto to any financial insurer) and/or an assignment in connection with a securitization transaction secured by a Leasehold Mortgage relating to the Utility System and granted to a Person pursuant to an agreement entered into prior to the occurrence of any Adverse Action, UMLLC Default, or any event of termination, cancellation, rescinding, or voiding referred to in Section 16.4 giving rise to the payment of amounts for or in respect of termination under this Agreement. For the purposes of determining the Utility System Concession Value, Leasehold Mortgage Debt shall not include: (i) debt from an Affiliate of the Concessionaire, unless such debt is on terms consistent with terms that would be reasonably expected from a non-Affiliate lender acting in good faith and otherwise complies with the requirements of Leasehold Mortgage Debt set forth above; (ii) any increase in debt to the extent such increase is the result of an agreement or other arrangement entered into after the Concessionaire was aware (or should have been aware), using reasonable diligence, of the prospective occurrence of an event giving rise to the payment of Leasehold Mortgage Debt; or (iii) any debt with respect to which the Leasehold Mortgagee did not provide UMLLC with notice of its Leasehold Mortgage in accordance, in all material respects, with the Leasehold Mortgage Notice Requirements.

“Leasehold Mortgagee” means the holder or beneficiary of a Leasehold Mortgage or a trustee or agent acting on behalf of such holder or beneficiary, including the Lessor in a lease or Leveraged Lease.

“Leasehold Mortgagee Notice Requirements” means the delivery by a holder or beneficiary of a Leasehold Mortgage to UMLLC, not later than ten (10) Days after the execution and delivery of such Leasehold Mortgage by the Concessionaire, of a true and complete copy of the executed

original of such Leasehold Mortgage, together with a notice containing the name and post office address of the holder of such Leasehold Mortgage, which may be an agent on behalf of the provider of the Leasehold Mortgage Debt.

“Leasehold Mortgagee’s Notice” has the meaning ascribed thereto in Section 19.7(a).

“Legislature” means the Louisiana State Legislature.

“Lessor” means a Leasehold Mortgagee that has purchased all or a portion of the Concessionaire Interest and leased that interest in the Concessionaire Interest to the Concessionaire.

“Letter of Credit” means a committed, irrevocable, unconditional, commercial letter of credit, in favor of UMLLC, in form and content reasonably acceptable to UMLLC, payable in U.S. dollars upon presentation of a sight draft and a certificate confirming that UMLLC has the right to draw under such letter of credit in the amount of such sight draft, without presentation of any other Document, which letter of credit (i) is issued by a commercial bank or trust company that is a member of the New York Clearing House Association or the Clearing House Interbank Payments System and that has a current credit rating of A-2 or better by Standard & Poor’s Ratings Services and an equivalent credit rating by another Credit Rating Agency (or such other commercial bank or trust company reasonably acceptable to UMLLC and Approved by UMLLC prior to the submission of the letter of credit) or such other commercial bank or trust company that is Approved by UMLLC, and (ii) provides for the continuance of such letter of credit for a period of at least one (1) Year or as otherwise provided in this Agreement. The office for presentment of sight drafts specified in the Letter of Credit shall be located (a) at a specified street address within the City of Baton Rouge, Louisiana or other location acceptable to UMLLC or (b) at a facsimile number located within the United States.

“Leveraged Lease” means a lease, sublease, concession, management agreement, operating agreement or other similar arrangement in which the Lessor has borrowed a portion of the purchase price of the interest in the Concessionaire Interest acquired by the Lessor and granted to the lenders of those funds a security interest in that interest.

“LIBOR” means the London Interbank Offered Rate.

“Loss” means, with respect to any Person, any loss, claim, liability, damage, penalty, amount paid pursuant to a settlement, charge, or out-of-pocket and documented cost or expense (including fees and expenses of counsel and any Tax losses) actually suffered or incurred by such Person but excluding any punitive, special, exemplary, indirect, and consequential damages and any contingent liability until such liability becomes actual, except, for the avoidance of doubt, to the extent the same are part of a Third Party Claim pursuant to Article 12 (provided that, for the avoidance of doubt, an actual loss, claim, liability, damage of any Contractor or Representative of the Concessionaire and for which the Concessionaire is liable subject only to receiving payment in respect thereof from UMLLC, shall not be treated as a contingent liability for this purpose).

“LSU” has the meaning ascribed thereto in the recitals of this Agreement.

“Main Powerhouse” means the “Main Powerhouse” as described or depicted Schedule 3A.

“Major KPI Event” means any single KPI Event that obligates the Concessionaire to pay KPI Compensation to UMLLC, with respect to that KPI Event only, in an amount equal to the greater of (i) two million five hundred thousand dollars (\$2,500,000) and (ii) ten percent (10%) of the Utility Fee.

“Material Adverse Effect” means a material adverse effect (after taking into account contemporaneous material positive effects) on the business, operations, financial condition, or results of operations of the Utility System taken as a whole or on the ability of UMLLC to consummate the Transaction or perform any material obligation hereunder; *provided, however*, that no effect arising out of or in connection with or resulting from any of the following shall be deemed, either alone or in combination, to constitute or contribute to a Material Adverse Effect: (i) general economic conditions or changes therein; (ii) financial, banking, currency or capital markets fluctuations or conditions (either in the United States of America or any international market and including changes in interest rates); (iii) conditions affecting the financial services or utility industries generally; (iv) any existing event or occurrence of which the Concessionaire has actual knowledge as of the Turnover Date; (v) any action, omission, change, effect, circumstance, or condition contemplated by this Agreement or attributable to the execution, performance, or announcement of this Agreement or the Transaction (except for any litigation relating thereto or to this Agreement (or the matters contemplated herein)); and (vi) negligence, intentional misconduct, or bad faith of the Concessionaire or its Representatives.

“Material Change” means any material change in the dimensions, character, quality, or location of any part of the Utility System that would not be considered Capital Improvements.

“Maximum Budgeted IMP Amount” has the meaning ascribed thereto in Section 2.4(f).

“Memorandum of Sub-Lease” has the meaning ascribed thereto in Section 2.8.

“New Agreement” has the meaning ascribed thereto in Section 19.5(a).

“New Approved Capital Improvement” has the meaning ascribed thereto in Schedule 5.

“New Approved Capital Improvement Cost” has the meaning ascribed thereto in Schedule 5.

“Notice Period” has the meaning ascribed thereto in Section 12.4(b).

“Obligation Payment” has the meaning ascribed thereto in Section 12.7.

“Obligee” means any Person entitled to the benefit of a payment obligation under Article 12.

“Obligor” means any Person obligated to meet a payment obligation under Article 12.

“Offsets” has the meaning ascribed thereto in Section 12.11(a).

“Open Book Basis” means, with respect to the proposed costs of any Capital Improvement, allowing UMLLC and the University to review all underlying assumptions and data associated

with the cost of delivering such Capital Improvement, including, without limitation, assumptions as to costs of the design, construction, and installation of such Capital Improvement, schedule, composition of equipment spreads, equipment rates, labor rates, productivity, estimating factors, design and productivity allowance, contingency and indirect costs, risk pricing, discount rates, interest rates, inflation and deflation rates, and other items reasonably required by UMLLC or the University to satisfy themselves as to the reasonableness and accuracy of the amount.

“Operating Agreement” means any material agreement, contract, or commitment to which the Concessionaire is a party or otherwise relating to the Utility System Operations as in force from time to time (including any warranties or guaranties), but excluding any Leasehold Mortgage and financing documents related thereto.

“Operating Agreements and Plans” has the meaning ascribed thereto in Section 3.11(a).

“Operations Plan” has the meaning ascribed thereto in Schedule 2.

“Operator” has the meaning ascribed thereto in Section 3.3(a).

“Operator Evaluation Period” means, as applicable, (i) the period commencing on the Day immediately following the Turnover Date and ending on the first (1st) anniversary thereof or (ii) each subsequent one (1) -year period after the period described in clause (i). For the avoidance of doubt, such one (1) -year period is a fixed period, rather than a rolling period.

“Parallel Issue” has the meaning ascribed thereto in Section 1.22.

“Party” means a party to this Agreement and “Parties” means both of them.

“Pass-Down Provisions” has the meaning ascribed thereto in Section 1.23.

“Payment Bond” has the meaning ascribed thereto in Section 21.6(a)(i).

“Performance Bond” has the meaning ascribed thereto in Section 21.6(a)(ii).

“Performance Standards” means (i) for the period commencing upon Turnover until the IMP Substantial Completion of the Initial Modernization Project, the Interim Performance Standards, and (ii) for the period commencing upon IMP Substantial Completion of the Initial Modernization Project through the remainder of the Term, the standards, specifications, policies, procedures, and processes that apply to the operation of, maintenance of, and rehabilitation of the Utility System set forth in Schedule 2A and the appendices thereto (as may be modified pursuant to the terms hereof). To the extent that any term or provision set forth in Schedule 2A or incorporated by reference in Schedule 2A conflicts with any term or provision specified in this Agreement, then such term or provision of this Agreement shall govern and shall supersede any such conflicting term or provision.

“Permitted Concessionaire Encumbrance” means, with respect to the Concessionaire Interest: (i) any Encumbrance that is being contested in accordance with Section 3.5(a) (but only for so long as such contest effectively postpones enforcement of any such Encumbrance); (ii) any (A) lien or security interest for obligations not yet due and payable to a Contractor or other Person,

(B) statutory lien, deposit, or other non-service lien or (C) lien, deposit, or pledge to secure mandatory statutory obligations or performance of bids, tenders, contracts (other than for the repayment of borrowed money) or leases, or for purposes of like general nature, any of which are incurred in the ordinary course of business of all or any part of the Utility System Operations and are either (x) not delinquent or (y) which are being contested, or being caused to be contested, by the Concessionaire in accordance with Section 3.5(a) (but only for so long as such contest effectively postpones enforcement of any such Encumbrance); (iii) inchoate materialmen's, mechanics', workmen's, repairmen's, employees', carriers', or warehousemen's liens or other like Encumbrances arising in the ordinary course of business of all or any part of the Utility System or the Concessionaire's performance of any of its rights or obligations hereunder, and either (A) are not delinquent or (B) are being contested by the Concessionaire in accordance with Section 3.5(a) (but only for so long as such contest effectively postpones enforcement of any such Encumbrance); (iv) any right reserved to or vested in any Governmental Authority or UMLLC by any statutory provision or under common law (it being understood and agreed that nothing in this clause (iv) shall limit or otherwise affect UMLLC's obligations or the Concessionaire's rights hereunder); (v) any other Encumbrance permitted hereunder (including any Leasehold Mortgage (and financing statements or other means of perfection relating thereto)); (vi) liens incurred in the ordinary course of business in connection with workers' compensation, unemployment insurance, social security, and other governmental rules and that do not in the aggregate materially impair the use, value, or operation of the Utility System; (vii) any Encumbrances created, incurred, assumed, or suffered to exist by UMLLC or any Person claiming through UMLLC; (viii) any Encumbrance, security interest, or pledge imposed upon the Concessionaire and any Affiliate as to the Concessionaire's and any Affiliate's assets arising from borrowings, financings, leases or similar transactions in the ordinary course of business; (ix) any Encumbrances in existence as of Turnover not caused by the Concessionaire, the Operator, or any of their respective Representatives; and (x) any amendment, extension, renewal or replacement of any of the foregoing.

"Permitted UMLLC Encumbrance" means: (i) the Concessionaire Interest; (ii) any Encumbrance that is being contested, or being caused to be contested, by UMLLC in accordance with Section 3.5(b) (but only for so long as such contest effectively postpones enforcement of any such Encumbrance); (iii) inchoate materialmen's, mechanics', workmen's, repairmen's, employees', carriers', or warehousemen's liens or other like Encumbrances arising in UMLLC's performance of any of its rights or obligations hereunder, and either (A) are not delinquent or (B) are being contested, or are being caused to be contested, by UMLLC in accordance with Section 3.5(b) (but only for so long as such contest effectively postpones enforcement of any such Encumbrance); (iv) any easement, covenant, condition, right-of-way, or servitude (or other similar reservation, right, and restriction) or other defects and irregularities in the title to the applicable assets that do not materially interfere with the Utility System Operations or the rights and benefits of the Concessionaire under this Agreement or materially impair the value of the Concessionaire Interest from and after the Turnover Date; (v) any zoning, building, environmental, health, safety, or other Law; (vi) the police and regulatory powers of the State or the City-Parish with respect to the Utility System, and the regulation of the use of the Public Way (it being understood and agreed that nothing in this clause (vi) shall prevent any exercise of such powers being an Adverse Action if it meets the definition thereof); (vii) any right reserved to or vested in any Governmental Authority by any statutory provision or under common law (it being understood and agreed that nothing in this clause (vii) shall prevent any exercise of such right being an Adverse Action if it meets the definition thereof); (viii) any other Encumbrance permitted hereunder; (ix) any

Encumbrances created, incurred, assumed, or suffered to exist by the Concessionaire or any Person claiming through it (provided that this shall not grant the Concessionaire, or any Person claiming through the Concessionaire, the right to create, incur, assume, or suffer to exist any such Encumbrance unless otherwise expressly contemplated herein); (x) any rights reserved to or vested in the University or UMLLC by any statutory provision (it being understood and agreed that nothing in this definition shall limit or otherwise affect UMLLC's obligations or the Concessionaire's rights hereunder); (xi) any of the Encumbrances set forth on Schedule 10; (xii) (A) any Encumbrances reflected in any leasehold title insurance policies (or any other title policies related to the Transaction) issued to the Concessionaire or any Leasehold Mortgagee in connection with the Transaction, or (B) if no such policies are issued in connection with the Transaction, any Encumbrances reflected in the Title Commitment which are not cured, satisfied, released or removed from the Title Commitment prior to closing of financing of the Initial Modernization Project; (xiii) the University Lease; and (xiv) any amendment, extension, renewal or replacement of any of the foregoing.

“Person” means any individual (including, the heirs, beneficiaries, executors, legal representatives or administrators thereof), corporation, partnership, joint venture, trust, limited liability company, limited partnership, joint stock company, unincorporated association, or other entity or a Governmental Authority, including the University and UMLLC.

“Planned IMP Substantial Completion Date” means May 30, 2024, as such date may be extended in accordance with the terms of this Agreement.

“Preliminary Design” shall mean the approximately thirty percent (30%) design for the Initial Modernization Project attached hereto as Schedule 7, which Preliminary Design shall include the Maximum Budgeted IMP Amount for the final design and construction of one hundred percent (100%) of the Initial Modernization Project pursuant to the Drop-Down DB Contract.

“Project Intellectual Property” has the meaning ascribed thereto in Section 3.11(b).

“Property” has the meaning ascribed thereto in the recitals of this Agreement.

“Property Taxes” means any ad valorem property Tax attributable to the Utility System or the Concessionaire Interest, including an ad valorem tax on real property and improvements, buildings, structures, fixtures and all tangible personal property.

“Prorated Items” means all revenues, charges, costs, and expenses with respect to Assumed Liabilities.

“Prudent Industry Practices” means, at a particular time, those practices, methods, standards, and acts which are engaged in and generally accepted by prudent providers of services of the kind contemplated by this Agreement in the United States, taking into account practices, methods, and acts in use at Comparable Utility Systems or individual utility facilities forming part of Comparable Utility Systems, life-cycle maintenance costs and considerations, and the design, engineering, construction, testing, operation, and maintenance requirements set out in this Agreement, and which, in the exercise of reasonable judgment at the time the decision was made, could reasonably have been expected to achieve the desired result consistent with applicable Law, safety, reliability, efficiency and expedition. “Prudent Industry Practices” is not intended to be

limited to the optimum practice or method to the exclusion of all others, but rather to be a spectrum of reasonable practices, methods, standards and acts.

“Public Way” means the streets, alleys, driveways, and sidewalks owned by the University.

“Quarter” means each calendar quarter of each Fiscal Year of the Term.

“Reconciliation Statement” has the meaning ascribed thereto in Section 7.1(b).

“Record Design Documents” means the IMP Design Documents which provide the complete and final documents necessary or related to construction, operations, and maintenance of the Initial Modernization Project or any portion thereof.

“Record Retention Policy” has the meaning ascribed thereto in Section 3.12(a).

“Recovery Period” has the meaning ascribed thereto in Schedule 5.

“Release” means depositing, spilling, leaking, pumping, pouring, emitting, discarding, abandoning, emptying, discharging, injecting, escaping, leaching, dumping, or disposing of any Hazardous Substances into the Environment.

“Repetitive Failure” means a Repetitive Non-Major KPI Event or a Repetitive Performance Standards Failure.

“Repetitive Non-Major KPI Event” means, during any given Operator Evaluation Period, the occurrence of a KPI Event for a particular Key Performance Indicator three (3) or more times during such Operator Evaluation Period.

“Repetitive Performance Standards Failure” means, during any given Operator Evaluation Period, the failure to comply with or to meet a distinct requirement of the Performance Standards (provided that UMLLC shall have provided separate written notices for each such failure) three (3) or more times during such Operator Evaluation Period.

“Representative” means, with respect to any Person, any director, officer, employee, official, partner, member, owner, agent, lawyer, accountant, auditor, professional advisor, consultant, engineer, Contractor, other Person for whom such Person is at law responsible or other representative of such Person and any professional advisor, consultant or engineer designated by such Person as its “Representative”. For the avoidance of doubt, the Operator (if other than the Concessionaire) shall be deemed a Representative of the Concessionaire.

“Required Coverages” has the meaning ascribed thereto in Section 13.2.

“Restoration” has the meaning ascribed thereto in Section 13.4(a)(ii).

“Restoration Funds” has the meaning ascribed thereto in Section 13.4(a)(iii).

“Restoration Shortfall Amount” has the meaning ascribed thereto in Section 13.4(a)(iii).

“Restricted Person” means any Person that (a) to the knowledge of the Concessionaire after reasonable diligence and due inquiry, directly or indirectly, is acting in contravention of any United States or other applicable international anti-money laundering regulations or conventions, (b) is included on the List of Specially Designated Nationals and Blocked Persons maintained by the United States Treasury Department’s Office of Foreign Assets Control (“OFAC”), which list may be found at www.treas.gov/ofac, (c) operating, organized, or residing in a country or territory named on an OFAC list or which is designated as a Non-Cooperative Jurisdiction by the Financial Action Task Force on Money Laundering, which designation can be found at www.fatf-gafi.org, or whose funds are transferred from or through such a jurisdiction, (d) operates, resides in, or is organized under the laws of a jurisdiction designated by the Secretary of the Treasury as warranting special measures due to money laundering concerns, which designation can be found at www.fincen.gov, (e) is a Foreign Shell Bank, or (f) has been debarred or suspended for cause from entering into contracts with the University or the State.

“Reversion Date” means the Business Day immediately following the End Date.

“Revised Proration Statement” has the meaning ascribed thereto in Section 2.2(b)(ii).

“Satellite Plants” means, collectively, each plant located adjacently and supplying Utilities to any of the following locations on the University Campus: (a) the South Campus, (b) the Nicholson Gateway Building, (c) the Recreation Center Building, (d) the Laboratory School Building, (e) the Union Center Building, (f) the 459 Complexes, (g) The Five Building, (h) the Cypress Building, and (i) the Ed Gay Building.

“SC Punch List” means the itemized list of Construction Work that remains to be completed in order to satisfy the conditions to achieving IMP Substantial Completion, prepared by the Concessionaire and included in the D&C Closeout Plan in accordance with Section 21.1.

“Schedule” means a schedule attached hereto and incorporated in this Agreement, unless otherwise expressly indicated by the terms of this Agreement.

“Securities Act” means the United States Securities Act of 1933, as amended.

“Senior Officials” has the meaning ascribed thereto in Section 3.3(c)(i)(A).

“Shared Spaces” has the meaning ascribed thereto in Section 3.30.

“State” means the State of Louisiana.

“Supplies” has the meaning ascribed thereto in Section 7.3(a).

“Supply Contract” has the meaning ascribed thereto in Section 7.3(a).

“Supply Costs” means the purchase price of Supplies in accordance with the applicable Supply Contract, inclusive of any taxes, including sales, use or excise taxes, applicable to such Supplies and all out-of-pocket costs incurred in the procurement of Supplies (including any transmission costs, riders or other similar costs reasonably necessary to procure Supplies).

“Target” has the meaning ascribed thereto in Schedule 15.

“Tax” means any federal, state, local, or foreign income, gross receipts, commercial activity, license, payroll, employment, excise, severance, stamp, occupation, premium, windfall profits, environmental, customs duties, permit fees, capital stock, franchise, profits, withholding, social security, unemployment, disability, real property, personal property, parking, sales, use, transfer, registration, value added, alternative or add-on minimum, estimated or other tax, levy, impost, stamp tax, duty, fee, withholding or similar imposition of any kind payable, levied, collected, withheld, or assessed at any time, including any interest, penalty or addition thereto, whether disputed or not.

“TEP” has the meaning ascribed thereto in the recitals of this Agreement.

“Term” has the meaning ascribed thereto in Section 2.1.

“Termination Damages” has the meaning ascribed thereto in Section 14.2(a).

“Third Party Agreement” has the meaning ascribed thereto in Section 3.18.

“Third Party Claim” means any Claim asserted against an Obligee by any Person who is not a Party or an Affiliate of such a Party.

“Time of Turnover” means 9:00 a.m. in Baton Rouge, Louisiana, on the Turnover Date.

“Title Commitment” means any commitment obtained by the Concessionaire, at its cost, for a leasehold title policy or policies, proposing to insure the leasehold interest of the Concessionaire in the Utility System Land, to the extent of such leasehold interest, prior to Turnover, issued by Title Company.

“Title Company” means [●] through Phelps Title Agency, L.L.C.

“Transaction” has the meaning ascribed thereto in Section 2.1.

“Transfer” means to sell, convey, assign, lease, sublease, mortgage, encumber, transfer, or otherwise dispose of.

“Transferee” means any Person who obtains the Concessionaire Interest pursuant to a Transfer.

“Turnover” has the meaning ascribed thereto in Section 2.2(a).

“Turnover Date” has the meaning ascribed thereto in Section 2.2(a).

“Ultimate Holding Entity” means, in relation to any Person, the ultimate holding entity of that Person, and in respect of the Concessionaire as of the date of this Agreement, means: (i) (A) QIC Investments No. 1 Pty Ltd as trustee for QIC Global Infrastructure Fund (Australia) No. 1 Trust, (B) QIC Infrastructure Management No. 2 Pty Ltd as trustee for QIC Global Infrastructure Fund (Australia) No. 2 Trust, or (C) QIC Global Infrastructure Fund US AIV LP; (ii) Ullico

Infrastructure Master Fund, L.P.; (iii) California Public Employees' Retirement System; or (iv) any of the foregoing.

“UMICEA” has the meaning ascribed thereto in the recitals of this Agreement.

“UMLLC” has the meaning ascribed thereto in the preamble to this Agreement.

“UMLLC Default” has the meaning ascribed thereto in Section 16.2(a).

“UMLLC Directive” means a written order or directive prepared by or on behalf of UMLLC in conformity with the requirements and limitations of this Agreement directing the Concessionaire, to the extent permitted hereby, other than pursuant to Section 3.21, to: (i) add to, or perform work in respect of, the Utility System in addition to that provided for in this Agreement (including (a) work within the University Campus on utility facilities or energy equipment that are not and will not be considered part of the Utility System in accordance with the definition thereof, (b) taking control of the internal UMLLC billing system for Utilities, and (c) causing the Concessionaire to engage in sustainability practices in excess of those reasonably required by Prudent Industry Practices); or (ii) change the dimensions, character, quantity, quality, description, location, or position of any part of the Utility System or make other changes to the Utility System; *provided that*, notwithstanding the foregoing, (1) as part of any such order or directive or as a separate order or directive, UMLLC may cause certain personal property to be deemed Utility System Assets and part of the Utility System even if such personal property is beyond the line of demarcation for the applicable Utility as set forth in the Performance Standards and may cause the Concessionaire to purchase and/or install such personal property, provided that if any such personal property would be beyond the line of demarcation for the applicable Utility as set forth in the Performance Standards, such order or directive may only be issued with the approval of the Concessionaire, acting reasonably, (2) any such order or directive can include the design, demolition, project management, construction, repair, replacement, remodeling, renovation, reconstruction, enlargement, addition, alteration, painting, or structural or other improvements not included in the Utility Facilities but related thereto, provided that such work must be part of a larger project (as determined by UMLLC in its reasonable discretion) for which the Utility System is the primary driver of such project (as determined by UMLLC in its reasonable discretion), (3) UMLLC may, in any such order or directive, direct the manner and means by which the Concessionaire performs a UMLLC Directive, and (4) no such order or directive may in any event order or direct the Concessionaire to do any act that is not technically feasible or could reasonably be expected to violate any applicable Law, contravene any Consent or Authorization issued by a Governmental Authority, cause a material insured risk to become uninsurable or cause the Concessionaire to fail to be in compliance with this Agreement. Notwithstanding anything herein to the contrary, UMLLC may not issue a UMLLC Directive to the Concessionaire for any portion of the Building Mechanical Systems.

“UMLLC Liaison” means the University’s [●], or such other Person as may be identified by UMLLC to the Concessionaire in writing.

“UMLLC Required Coverages” has the meaning ascribed thereto in Section 13.2.

“UMLLC Responsible Parties” has the meaning ascribed thereto in Section 12.2.

“UMLLC’s Option” has the meaning ascribed thereto in Section 19.7(a).

“Unexpended Contingency Amount” means an amount equal to the difference between (a) [five million dollars (\$5,000,000)] and (b) the cumulative amount of funds actually disbursed by the Concessionaire prior to the IMP Substantial Completion Date from reserves designated by the Concessionaire for contingencies in the Approved Budgeted Amount pursuant to Section 2.4(f); *provided* that in no event shall the Unexpended Contingency Amount be less than zero dollars (\$0.00).

“Uncapped O&M Costs” means the sum of the following specifically identified out-of-pocket operating and maintenance costs and expenses incurred by the Concessionaire (which costs and expenses shall include payments due and payable by the Concessionaire to the Operator or other Contractors pursuant to an Operating Agreement or similar agreement) or the Operator in operating the Utility System and complying with their respective obligations under this Agreement: (a) costs incurred due to a Delay Event, provided that for events described in clause (iii) of the definition of “Delay Event”, Uncapped O&M Costs shall only include those costs (which are not costs incurred to make Capital Improvements) necessary to bring the Utility System into compliance with the applicable Law and not the ongoing costs associated therewith; (b) costs incurred to modify the location or configuration of the Utility System as directed by UMLLC pursuant to Section 3.21 (but only to the extent such costs are not costs incurred to make a Capital Improvement); (c) costs incurred by the Concessionaire pursuant to Section 4.3(c)(ii) if the relevant proposed Capital Improvement or Material Change is not Approved by UMLLC; (d) costs incurred to disconnect real property from the Utility System if required pursuant to Section 5.3(a); (e) costs incurred in connection with a modification to the Performance Standards pursuant to Section 6.3(a); (f) costs incurred to perform the obligations set forth in Section 7.4, but only to the extent such costs were Approved by UMLLC prior to being incurred; (g) costs incurred to pay Property Taxes, if such costs are included in Uncapped O&M Costs pursuant to Section 3.8; (h) costs incurred to make time-sensitive repairs or improvements to (A) the Utility System or (B) UMLLC-owned property related to, but not a part of, the Utility System, in each case to the extent such repairs or improvements (w) are not Capital Improvements, (x) were not contemplated in the most recently approved Five-Year Plan, (y) were either (I) made in the Concessionaire’s good-faith belief that they were being made to the Utility System or (II) made in the Concessionaire’s good-faith belief that the repair was the best first response to an Emergency, and (z) have been Approved by UMLLC in its discretion; (i) storm water and sanitary effluent charges assessed by the City-Parish, except to the extent that such storm water and sanitary effluent charges increase as a result of an action or inaction of the Concessionaire (other than the actions or inactions that the Concessionaire is directed or obligated to take or omit pursuant to this Agreement, including in order to comply with the Performance Standards); (j) an Approved Capital Improvement that is classified as Uncapped O&M Costs pursuant to Section 4.3(h) or an Approved Material Change (unless such costs are treated as another form of compensation to the Concessionaire provided for in this Agreement in connection with the Approval of such Material Change), in each case up to the amount Approved by UMLLC as part of its Approval of such Capital Improvement or Material Change; (k) costs incurred in connection with Supply procurement assistance under Section 7.3(a) or Section 7.3(b), but only to the extent such costs were Approved by UMLLC prior to being incurred; (l) costs (including KPI Compensation) incurred as a direct result of the Concessionaire’s failure to comply with Law or this Agreement if the sole reason for such failure is that UMLLC failed to be reasonable in its Approval of all possible Capital Improvements or Material Changes

that would cure or prevent such failure to comply with such Law or this Agreement; (m) costs associated with a UMLLC Directive that is not the construction of a Capital Improvement in accordance with Section 5.1, (n) legal fees arising out of any Excluded Liabilities; (o) the costs of any premium for insurance coverage procured by the Concessionaire in accordance with Section 13.1; *provided* that such coverage and the cost thereof has been Approved by UMLLC prior to the purchase thereof; *provided, further*, that with respect to any Approved Capital Improvement or Material Change, such coverage and the cost thereof is expressly included in the request for Approval of such Capital Improvement or Material Change and UMLLC Approves such cost; (p) the operations and maintenance costs that are reasonably necessary to cause the Utility System or Utility System Operations to comply with the enactment of a new Law or the modification, amendment or change in enforcement or interpretation of a Law (including a change in the application or implementation thereof by any Governmental Authority) arising after the Turnover Date but solely for the first 3 full Fiscal Years (and any partial Fiscal Year) after the occurrence of such enactment, modification, amendment or change (but not, for the avoidance of doubt, those costs that are included in any other clause of this definition; (q) operations and maintenance costs to the extent reasonably incurred by the Concessionaire to rectify an Extraordinary Failure that is neither insured pursuant to Article 13 nor caused by the act, omission, negligence, or willful misconduct of, or violation of applicable Law by, the Concessionaire, its Affiliates or their respective Representatives; and (r) a cost expressly described as an Uncapped O&M Cost in Section 3.7(c) or Section 3.7(e).

“University” has the meaning ascribed thereto in the recitals of this Agreement.

“University Campus” has the meaning ascribed thereto in the recitals to this Agreement as more particularly shown on Schedule 16.

“University Claim” has the meaning ascribed thereto in Section 1.20.

“University Lease” has the meaning ascribed thereto in the recitals of this Agreement, which University Lease is substantially in the form attached hereto as Schedule 23.

“University Leasing Act” has the meaning ascribed thereto in the recitals of this Agreement.

“University Reimbursable Amount” means an amount equal to two and one half percent (2.5%) of the gross amount of the Concessionaire’s financing of the Initial Modernization Project but in no event less than [two million five hundred thousand dollars (\$2,500,000)].

“University Utility System Employees” means those Persons identified on Schedule 4A employed by the University immediately prior to Turnover whose duties directly relate to the operation or maintenance of the Utility System.

“Unplanned Outage” has the meaning ascribed thereto in Schedule 2A or Schedule 2B, as applicable.

“Unrecovered Balance” has the meaning ascribed thereto in Schedule 5.

“Utilities Modernization Initiative” has the meaning ascribed thereto in the recitals of this Agreement.

“Utility” means any of the following specific individual utility services: (i) electricity; (ii) steam and condensate; (iii) chilled water; and (iv) natural gas, and “Utilities” means each of them.

“Utility Facilities” means the improvements and equipment (a) constituting part of those identified in Schedule 3A, that are directly and exclusively involved in the generation, distribution, and return of the Utilities and the operation and maintenance of the Utility System and that are not beyond the line of demarcation for each Utility as set forth in the Performance Standards, or (b) located on Utility System Land; *provided* that the definition of “Utility Facilities” does not include (i) any improvements or equipment that are beyond the line of demarcation for each Utility as set forth in the Performance Standards, except for those areas (I) expressly set forth in the Performance Standards as being within said line of demarcation or (II) which UMLLC directs to be part of the Utility System as part of a UMLLC Directive in accordance with the definition thereof, (ii) any cameras or other public safety equipment installed, maintained, or used by the Louisiana State University Police Department or any successor department, (y) the Satellite Plants, or (iii) any portion of the Building Mechanical Systems. For the avoidance of doubt, except as set forth in the definition of Distribution Bottlenecks, no part of the Distribution System shall be included within the scope of the Utility Facilities unless and until such part of the Distribution System has become the subject of a Distribution System Capital Improvement.

“Utility Fee” means the fee established as compensation for the Utility Services, as set forth on Schedule 5 and as may be adjusted pursuant to the terms of this Agreement, including Schedule 5.

“Utility Services” means the services to be provided by the Concessionaire as grantee of the concession under this Agreement. For the avoidance of doubt, no services in respect of the Distribution System shall be included within the scope of the Utility Services unless and until such part of the Distribution System has become the subject of a Distribution System Capital Improvement.

“Utility System” means: (A) the personal property, real property, improvements, fixtures, and equipment owned and operated by the University or UMLLC prior to the Time of Turnover to provide the Utilities on the University Campus, specifically limited to (i) the Utility System Assets, (ii) the computer systems and software set forth on Schedule 12, (iii) the Utility Facilities, and (iv) the Utility System Land; *provided, however*, that the “Utility System” shall not include, other than expressly referred to above, (v) any utility distribution facilities or other equipment that is beyond the line of demarcation for each Utility, as set forth in the Performance Standards, except to the extent incorporated into the Utility System by a UMLLC Directive, (w) any interest in the Public Way or similar real property, (x) any utility facilities in a building that is not a building leased by the Concessionaire, up to the Utility System line of demarcation for such building, as described in the Performance Standards, except to the extent incorporated into the Utility System by a UMLLC Directive, (y) the Satellite Plants, or (z) any portion of the Building Mechanical Systems; and (B) from and after the Time of Turnover, such Utility System as it is reconfigured, replaced, improved, or relocated by the Concessionaire or the Operator pursuant to the terms of this Agreement. For the avoidance of doubt, except as set forth in the definition of Distribution

Bottlenecks, no part of the Distribution System shall be included within the scope of the Utility System unless and until such part of the Distribution System has become the subject of a Distribution System Capital Improvement.

“Utility System Assets” means (i) as of the time immediately prior to the Time of Turnover, the personal property of the University or UMLLC used in connection with operations of the Utility System and identified on Part 3 of Schedule 3A as “Personal Property,” and (ii) in addition to the personal property described in clause (i) above, from and after the Time of Turnover, the personal property of the Concessionaire or the Operator used in connection with the operations of the Utility System; *provided* that the definition of “Utility System Assets” does not include any portion of the Building Mechanical Systems.

“Utility System Concession Value” means, at any given date, the fair market value of the Concessionaire Interest at the time of the occurrence of the relevant Adverse Action, UMLLC Default, or any event of termination, cancellation, rescinding, or voiding referred to in Section 16.4 (but excluding the effect of such Adverse Action, UMLLC Default, or event described in Section 16.4), as determined pursuant to a written appraisal prepared in conformity with the Uniform Standards of Professional Appraisal Practice as set forth by the Appraisal Standards Board, or its successor organization, by an independent third party appraiser that is nationally recognized in appraising similar assets and that is acceptable to UMLLC and the Concessionaire; *provided* that in no event shall such appraisal take into account any Capital Improvement not Approved by UMLLC prior to such time; *provided, further*, that the Utility System Concession Value shall in no event be less than the amount of all Leasehold Mortgage Debt (including Breakage Costs) on the End Date. If the Parties fail to agree upon such a single appraiser within thirty (30) Days after a Party requests the appointment thereof, then UMLLC and the Concessionaire shall each appoint an independent third party appraiser and both such appraisers shall be instructed jointly to select an independent third party appraiser to make the appraisal referred to above. Each of UMLLC and the Concessionaire shall pay fifty percent (50%) of the costs and expenses of any appraisal.

“Utility System Land” means those parcels of real property described or depicted in Schedule 3A for the Main Powerhouse, the Cogeneration Building, the Highland Utility Center, and the Vet Med Plant.

“Utility System Operations” means the operation, management, and maintenance of the Utility System and all other actions relating to the Utility System that are performed by or on behalf of the Concessionaire pursuant to this Agreement.

“Utility System Purposes” means the use of the Utility System to provide Utility Services in support of UMLLC by providing utility services to UMLLC facilities on the University Campus, including to students, faculty, administrators, employees, and invitees of UMLLC thereon and others providing services to UMLLC.

“Variable Fee Component” has the meaning ascribed thereto in Schedule 5.

“Vet Med Plant” means heating and cooling plant located at the University’s School of Veterinary Medicine, described or depicted as the “Vet Med Plant” on Schedule 3A.

“Warranty Period Utility System Projects” means those projects with respect to the Utility System completed by UMLLC prior to the Time of Turnover that remain subject to an ongoing warranty from the contractor responsible for completing such projects and are listed on Schedule 22.

“Year” means the calendar year.

Section 1.2. Number and Gender. In this Agreement, words in the singular include the plural and vice versa and words in one gender include all genders.

Section 1.3. Headings. The division of this Agreement into articles, sections, and other subdivisions is for convenience of reference only and shall not affect the construction or interpretation of this Agreement. The headings in this Agreement are not intended to be full or precise descriptions of the text to which they refer and shall not be considered part of this Agreement.

Section 1.4. References to this Agreement. The words “herein”, “hereby”, “hereof”, “hereto”, “hereunder”, and words of similar import refer to this Agreement as a whole, including the Schedules, and not to any particular portion of it. The words “Article”, “Section”, “paragraph”, “sentence”, “clause”, and “Schedule” mean and refer to the specified article, section, paragraph, sentence, clause, or schedule of or to this Agreement.

Section 1.5. References to Any Person. A reference in this Agreement to any Person at any time refers to such Person’s permitted successors and assignees.

Section 1.6. Meaning of Including. In this Agreement, the words “include”, “includes”, or “including” mean “include without limitation”, “includes without limitation”, and “including without limitation”, respectively, and the words following “include”, “includes”, or “including” shall not be considered to set forth an exhaustive list.

Section 1.7. Meaning of Discretion. In this Agreement, unless otherwise modified, the word “discretion” with respect to any Person means the sole and absolute discretion of such Person.

Section 1.8. Meaning of Notice. In this Agreement, the word “notice” means “written notice”, unless specified otherwise.

Section 1.9. Consents and Approvals. Unless specified otherwise, wherever the provisions of this Agreement require or provide for or permit an approval or consent by either Party, such approval or consent, and any request therefor, must be in writing (unless waived in writing by the other Party).

Section 1.10. Trade Meanings. Unless otherwise defined herein, words or abbreviations that have well-known trade meanings are used herein in accordance with those meanings.

Section 1.11. Laws. Unless specified otherwise, references to a Law are considered to be a reference to (i) such Law as it may be amended from time to time, (ii) all regulations and rules pertaining to or promulgated pursuant to such Law, (iii) the successor to the Law resulting from

recodification or similar reorganizing of Laws, and (iv) all future Laws pertaining to the same or similar subject matter.

Section 1.12. Currency. Unless specified otherwise, all statements of or references to dollar amounts or money in this Agreement are to the lawful currency of the United States of America.

Section 1.13. Generally Accepted Accounting Principles. All accounting and financial terms used herein, unless specifically provided to the contrary, shall be interpreted and applied in accordance with GAAP.

Section 1.14. Calculation of Time. For purposes of this Agreement, a period of Days shall be deemed to begin on the first Day after the event that began the period and to end at 5:00 p.m., which time shall be determined by the time in the City of Baton Rouge, Louisiana on the last Day of the period. If, however, the last Day of the period does not fall on a Business Day, the period shall be deemed to end at 5:00 p.m., which time shall be determined by the time in the City of Baton Rouge, Louisiana on the next Business Day.

Section 1.15. Approvals, Consents and Performance by UMLLC.

- (a) *Procedures.* Wherever the provisions of this Agreement require or provide for or permit an approval or consent by UMLLC of or to any action, Person, Document, or other matter contemplated by this Agreement, the following provisions shall apply: (i) such request for approval or consent must (1) contain or be accompanied by any documentation or information required for such approval or consent in reasonably sufficient detail, as reasonably determined by UMLLC, (2) clearly set forth the matter in respect of which such approval or consent is being sought, (3) form the sole subject matter of the correspondence containing such request for approval or consent, and (4) state clearly that such approval or consent is being sought; (ii) such approval or consent shall not be unreasonably withheld, conditioned, or delayed (unless such provision provides that such approval or consent may be unreasonably withheld, conditioned, or delayed or is subject to the discretion of UMLLC); (iii) UMLLC shall advise the Concessionaire by written notice either that it consents or approves or that it withholds its consent or approval, in which latter case it shall set forth, in reasonable detail, its reasons for withholding its consent or approval, which reasons may include the insufficiency, as determined by UMLLC acting reasonably, of the information or documentation provided; (iv) unless a time period is specifically set forth elsewhere herein, UMLLC shall, within thirty (30) Days after receipt of the Concessionaire's request, (1) provide the responding notice mentioned in clause (iii) of this Section 1.15(a) or (2) if UMLLC determines in its discretion that additional time to consider such request would be appropriate due to the request's complexity or interrelationship with larger UMLLC issues, advise the Concessionaire by written notice of a reasonable timeframe (not to exceed ninety (90) Days) in which UMLLC will provide the responding notice mentioned in clause (iii) of this Section 1.15(a), which written notice shall extend the timeframe for Approval of the request to the timeframe set forth in such notice; (v) if the responding notice mentioned in clause (iii) of this Section 1.15(a)

indicates that UMLLC does not approve or consent, the Concessionaire may take whatever steps may be necessary to satisfy the objections of UMLLC set out in the responding notice and, thereupon, may resubmit such request for approval or consent from time to time and the provisions of this Section 1.15 shall again apply; (vi) if the disapproval or withholding of consent mentioned in clause (iii) of this Section 1.15(a) is subsequently determined pursuant to Article 18 to have been improperly withheld or conditioned by UMLLC, such approval or consent shall be deemed to have been given on the date by which such approval or consent should have been provided; *provided* that, to the extent any deadlines for performing work are determined by reference to the date of consent or approval, such consent or approval shall be deemed to have been given on the date of determination rather than the date such consent or approval should have been provided; and (vii) for the avoidance of doubt, any dispute as to whether or not a consent or approval has been unreasonably withheld, conditioned or delayed shall be resolved in accordance with the provisions of Article 18. The Concessionaire shall submit any request for approval or consent to UMLLC Liaison, who will direct such request to the appropriate committee, Person or group within UMLLC.

- (b) *Approved Documents.* Subject to the other provisions hereof, wherever in this Agreement an approval or consent by UMLLC is required with respect to any document, proposal, certificate, plan, drawing, specification, contract, agreement, budget, schedule, report, or other written instrument whatsoever (a “Document”), following such Approval such Document shall not be amended, supplemented, replaced, revised, modified, altered, or changed in any manner whatsoever without obtaining a further Approval in accordance with the provisions of this Section 1.15.
- (c) *Consent by the University.* Wherever the provisions of this Agreement require or provide for or permit an approval or consent by UMLLC, such provisions shall be deemed also to require or provide for or permit the approval or consent by the University as precedent condition to the effectiveness of UMLLC’s approval or consent pursuant to this Section 1.15; *provided, however*, for the avoidance of doubt, such approval or consent by the University shall be a Parallel Issue.

Section 1.16. Incorporation of Schedules. The Schedules are integral to, and are made a part of, this Agreement. In the event of any conflict between the terms of this Agreement and the terms of the Schedules, the terms of this Agreement shall control.

Section 1.17. References to Agreements Generally. References to agreements (including this Agreement) and other contractual instruments shall be deemed to include all amendments, restatements, extensions and other modifications to such instruments, whether in effect as of the date hereof or made thereafter.

Section 1.18. Cost Responsibilities. In this Agreement, the phrases “at the Concessionaire’s sole cost and expense”, “at the Concessionaire’s cost and expense”, “the Concessionaire shall be responsible for providing”, “the Concessionaire shall pay”, “the Concessionaire shall reimburse”, and similar phrases and provisions that require the Concessionaire to take certain actions or perform certain services, shall not mean that such costs

or expenses, or the costs and expenses associated with such actions or activities, are necessarily subject to recovery as part of the Utility Fee or otherwise in accordance with this Agreement. The inclusion of such costs and expenses in the Utility Fee shall be determined in accordance with Schedule 5.

Section 1.19. Out-of-Pocket Costs. In this Agreement, any reference to “out-of-pocket” or “out of pocket” costs or expenses of the Concessionaire or Operator and similar phrases and provisions shall mean the reasonable, incremental actual costs paid by the Concessionaire or Operator to a third party that (i) is not an Affiliate of the Concessionaire, the Operator, or any Equity Participant or (ii) is an Affiliate of the Concessionaire, the Operator, or any Equity Participant, provided that the payments to such Affiliate are on arms’ length terms consistent with those terms offered by unaffiliated third parties for similar goods or services.

Section 1.20. Interaction with the University Lease.

- (a) Notwithstanding any other provision of this Agreement, to the extent that UMLLC is or becomes obligated under the University Lease to take any action, do anything or perform any obligation in connection with the Transaction, the Concessionaire agrees that, except as otherwise specified herein, it will be obligated to take any such action, do any such thing or perform any such obligation under this Agreement in the manner and to the standard specified herein or, in the absence of any such standard, such standard specified in the University Lease.
- (b) Where the University has the right to exercise any discretion, grant or refuse to grant an approval, accept or refuse to accept a request or submission, make any determination or confirm its satisfaction under the University Lease in respect of any matter, and UMLLC has a corresponding right to exercise any discretion, grant or refuse to grant an approval, accept or refuse to accept a request or submission, make any determination or confirm its satisfaction pursuant to the terms of this Agreement in respect of the same or substantially the same or similar matter, and where the University has exercised its rights in a particular manner, UMLLC shall only be entitled to exercise its discretion, grant or refuse to grant an approval, accept or refuse to accept a request or submission or make the relevant determination in a manner that is consistent with the discretion exercised, approval granted or refused, request or submission accepted or refused or determination made or level of satisfaction confirmed by the University under the University Lease.
- (c) Where the University asserts or exercises any right against UMLLC in accordance with the University Lease in regard to any matter associated with the Transaction or the Concessionaire, including reductions in or retentions from payments under the University Lease, claims for indemnification and claims for damages for breach of the University Lease (such assertion or exercise of rights by the University being referred to as a “University Claim”), any determination made or reached under the University Lease as to the amount, nature and extent of UMLLC’s liability in relation to any University Claim shall be binding on the Concessionaire, provided that UMLLC may not compromise any University Claim without the prior written consent of the Concessionaire, in its sole discretion. The Concessionaire shall bear

and discharge on a current basis, and shall indemnify UMLLC against all Losses reasonably and properly incurred by UMLLC related to any University Claim, except to the extent that (1) such Losses arise from a UMLLC Default or (2) the liability for the relevant University Claim will be shared by the Parties, in which case, each Party shall bear a fair and reasonable proportion of the related costs and expenses. For clarity, UMLLC will only share in the liability for a University Claim to the extent related to its specific obligations under this Agreement.

- (d) The Parties acknowledge that where the University Lease contemplates meetings between UMLLC and the University and/or any of their respective Representatives, such provisions generally do not necessarily contemplate a right for the Concessionaire to attend such meetings. UMLLC will use reasonable efforts to ensure that the Concessionaire is included in such meetings and, where UMLLC is not successful, UMLLC agrees to keep the Concessionaire informed of any such discussions or meetings between UMLLC and the University and to put forward all comments and questions provided to it by the Concessionaire in respect of the subject matter of the relevant discussions or meetings. UMLLC will not agree with the University on any matter at meeting in which the Concessionaire is not present and which could impact the obligations of the Concessionaire under this Agreement without the prior written consent of the Concessionaire.
- (e) In certain sections of this Agreement, there are references to or acknowledgements of the University Lease or portions thereof and the absence of such a reference or acknowledgement in any other particular section of this Agreement will not be construed for or against either party in interpreting this Agreement.

Section 1.21. Equivalent Project Relief.

- (a) Except to the extent any entitlement of UMLLC under the University Lease (including any rights, remedies or relief) does not, in any way, relate to the rights or obligations of the Concessionaire under this Agreement, the Concessionaire will be entitled to receive the benefit of such entitlement from UMLLC (in accordance with and subject to the provisions of Section 1.21(c)), including the benefit of:
 - (i) any compensation, damages or other payment of any kind on the same or substantially the same grounds as UMLLC is entitled to compensation, damages or other payment of any kind under the University Lease, including compensation on termination;
 - (ii) any other relief (including any extension of time) from the performance of its obligations under, or from termination of, this Agreement on the same or substantially the same grounds as UMLLC is entitled to be relieved from performance of equivalent obligations under, or from termination of, the University Lease;

- (iii) any entitlement of the Concessionaire under this Agreement in respect of which any provision of this Agreement states that the Pass-Down Provisions are to apply; and
- (iv) any certificate, consent, or approval granted under this Agreement, the University Lease or any other agreement, statute, bylaw or regulation in regard to any matter relating to the Concessionaire, including any entitlement of UMLLC to request or apply for such certificate, consent, or approval from the University, or any other Person under this Agreement or the University Lease,

including, for greater certainty, any benefit to UMLLC arising out of any modification implemented or required because of a University Directive pursuant to the University Lease, any Compensation Event, Delay Event, Force Majeure, or remedies or compensation in respect of any University Default (as defined in the University Lease) in respect of which UMLLC is entitled to relief, compensation or benefit under the University Lease in respect of UMLLC's obligations, but excluding any specific loss, cost or expense incurred by UMLLC to which the relevant compensation expressly relates and which is not included in any amount claimed by the Concessionaire.

UMLLC's entitlement under the University Lease in respect of the matters set out in this Section 1.21 is referred to in this Agreement as "Equivalent Project Relief".

- (b) The Concessionaire will not be entitled to any relief from, or waiver in respect of, performance of its obligations under this Agreement other than:
 - (i) to the extent UMLLC receives Equivalent Project Relief; or
 - (ii) to the extent expressly provided for in this Agreement.
- (c) The Concessionaire will be entitled to the benefit of any Equivalent Project Relief to the extent that UMLLC is or becomes entitled under the University Lease only if, when and to the same extent that UMLLC has received Equivalent Project Relief from the University under the University Lease.
- (d) For purposes of UMLLC asserting a claim under the University Lease against the University in respect of Equivalent Project Relief, where the Concessionaire has suffered Losses or otherwise claims relief in respect of any event or circumstance in respect of which UMLLC is entitled to claim Equivalent Project Relief, UMLLC acknowledges that it will be obligated to include such Losses or relief claimed by the Concessionaire in its claim against the University and to make such claim against the University under the University Lease, provided that the Concessionaire's recourse against UMLLC and UMLLC's liability to the Concessionaire in respect of any such Losses or relief will be subject to, and strictly limited by, the provisions of Sections 1.21(a) through 1.21(c) above and that UMLLC will not be required to reimburse the Concessionaire to the extent that such Losses or relief arise as a result of any failure on the part of the University to

perform its obligations under the University Lease, unless UMLLC has received compensation from the University under the University Lease in respect of such University failure, in which case the Pass-Down Provisions shall apply.

Section 1.22. Enforcement of Parallel Issues.

- (a) UMLLC will preserve, protect, and pursue under the University Lease such rights, remedies, and relief as may relate to the Concessionaire's rights and obligations hereunder, including any claim for Equivalent Project Relief, (a "Parallel Issue") in order to secure a favorable resolution of the Parallel Issue, provided that:
 - (i) UMLLC has received written notice from the Concessionaire of the Parallel Issue;
 - (ii) the Concessionaire will not be entitled to recover from UMLLC any Losses or claims arising out of or in connection with UMLLC pursuing resolution of a Parallel Issue on the Concessionaire's behalf other than any amounts received from the University in respect of such Parallel Issue; and
 - (iii) the Concessionaire will indemnify UMLLC in respect of any Losses arising out of or in connection with UMLLC pursuing resolution of a Parallel Issue on the Concessionaire's behalf in accordance with this Section 1.22(a), including reimbursing UMLLC for any deduction from, reduction of or exercise of set-off, compensation or similar right against any amount payable by the University associated therewith, provided that such indemnification will, unless UMLLC has no entitlement to any amount received in respect of such Parallel Issue, be proportionate to the ultimate entitlements of each party derived from pursuing resolution of such Parallel Issue.
- (b) Subject to Section 1.22(c), UMLLC consents to the Concessionaire pursuing the rights, remedies and relief under the University Lease described in Section 1.22(a) of this Agreement, including any entitlement to compensation on termination, in the name of UMLLC, which may, subject to the provisions of Section 12.4 of the University Lease, include the defense of claims where the Concessionaire is required to provide an indemnity to UMLLC in accordance with this Agreement. The Concessionaire will be responsible for the cost and expense of pursuing such rights, remedies and relief, provided that, if the Concessionaire is successful in pursuing any claim in respect thereof, such cost and expense will be allocated equitably between the Parties in proportion to their ultimate entitlements to same. UMLLC will, at the sole cost and expense of the Concessionaire, use commercially reasonable efforts to provide assistance, including providing documents, data, and information, as the Concessionaire may reasonably request in connection with the pursuit of such Parallel Issue by the Concessionaire.
- (c) No later than seven (7) days following receipt of the notice referred to in Section 1.22(a)(i), UMLLC may take conduct of the Parallel Issue and pursue the rights,

remedies and relief under the University Lease described in Section 1.22(a) of this Agreement on behalf of the Concessionaire and in accordance with the reasonable directions of the Concessionaire.

- (d) UMLLC will not enter into any compromise or settlement of a Parallel Issue with the University which affects, in any respect, the Concessionaire's obligations, rights, remedies or relief hereunder without the prior written consent of the Concessionaire, in its sole discretion.
- (e) Where UMLLC pursues a Parallel Issue in accordance with this Section 1.22, the Concessionaire will be kept informed of UMLLC's progress under this Section 1.22 and will be given the opportunity to comment on all submissions (written or oral) which are to be put forward by UMLLC in accordance with this Section 1.22.
- (f) The Concessionaire will, at its own cost and within the time frame contemplated by any relevant dispute resolution procedure, use commercially reasonable efforts to provide assistance, including providing documents, data, and information, as UMLLC may reasonably request in connection with the pursuit of any Parallel Issue.
- (g) Any claims in respect of a Parallel Issue and any recoveries obtained by UMLLC or the Concessionaire in respect of any Parallel Issue under the University Lease will be subject to the provisions of Section 1.21 in respect of Equivalent Project Relief.

Section 1.23. Pass-Down Provisions. The Parties acknowledge and agree that all provisions of this Agreement including the provisions of each Schedule hereto will be subject to the provisions of Section 1.20 through Section 1.22 of this Agreement (the "Pass-Down Provisions"), and the absence of any specific reference to the Pass-Down Provisions will not preclude the application of the Pass-Down Provisions to any provision of this Agreement.

Section 1.24. Communications with the University and Third Parties.

- (a) To the extent that any written notice, information, consent, claim, request, response, submission, or other communication (a "Communication") is required or permitted to be given or made by the Concessionaire directly to the University or any other third party under this Agreement, the Concessionaire will provide a copy of the same to UMLLC at the same time as giving or making the Communication to the University or such third party.
- (b) Except as otherwise specifically set out in this Agreement, UMLLC hereby gives permission to the Concessionaire to provide all Communications directly to the University.
- (c) UMLLC will make all Communications required to be made by UMLLC to the Concessionaire under this Agreement in a timely manner so as to permit the Concessionaire to comply with its obligations under this Agreement and will

consult with the Concessionaire in respect of all Communications with the University.

- (d) The Concessionaire will make all Communications required to be made by the Concessionaire to UMLLC under this Agreement in a timely manner so as to permit UMLLC to comply with its obligations under this Agreement.

Section 1.25. Louisiana Defined Terms. As used in this Agreement, the term “lien” will also mean a privilege, mortgage, security interest, assignment, or other encumbrance. The term “real property” or “real estate” will mean “immovable property” as that term is used in the Louisiana Civil Code. The term “personal property” will mean “movable property” as that term is used in the Louisiana Civil Code. The terms “fee simple interest” shall mean “full ownership interest” as that term is used in Louisiana law. The term “easement” will mean “servitude” as that term is used in the Louisiana Civil Code. The term “building” will also include “other constructions” as that term is used in the Louisiana Civil Code. The term “intangible” will mean “incorporeal” as that term is used in Louisiana law. The term “tangible” will mean “corporeal” as that term is used in Louisiana law. The term “condemnation” will include “expropriation” as that term is used in Louisiana law. The term “receiver” will include “keeper” as that term is used in Louisiana law. The term “fixtures” will mean component parts of the Land and/or the improvements.

ARTICLE 2

THE TRANSACTION; CONDITIONS PRECEDENT; COVENANTS

Section 2.1. Grant of Concession. Upon the terms and subject to the conditions of this Agreement, effective at the Time of Turnover:

- (a) UMLLC demises and subleases the Property to the Concessionaire free and clear of Encumbrances other than Permitted UMLLC Encumbrances and on an exclusive basis, other than as expressly provided in this Agreement, for and during the term (the “Term”) commencing on the Turnover Date and expiring on the thirtieth (30th) anniversary thereof (or such later date as may be required to effect a Delay Event Remedy but subject to earlier termination as provided in this Agreement), provided that such demise and sublease of the Utility Facilities and Utility System Assets other than those located on the Utility System Land shall not prevent UMLLC, the University, or any Governmental Authority from using, occupying, developing, leasing, or otherwise enjoying the real property and the improvements other than the land on which the Utility Facilities and Utility System Assets are located without the payment of any fee, charge or rent to the Concessionaire, and
- (b) UMLLC (i) grants the Concessionaire a non-exclusive license during the Term, appurtenant to the leasehold interest described in clause (a) above, to access the Public Way and other portions of the University Campus (subject to Section 3.2(b)), solely in order to operate, maintain, repair, replace, improve, and service the Utility Facilities and Utility System Assets located therein or thereon to the extent permitted or required under this Agreement, and (ii) grants the Concessionaire, free and clear of any Encumbrances (other than Permitted UMLLC Encumbrances) for

and during the Term, except as expressly provided in this Agreement (including as provided in Section 3.21 and Section 4.1), (x) an exclusive right to perform the Capital Improvements that are Approved pursuant to Section 4.3, (y) an exclusive right to design, build, and finance the Initial Modernization Project, subject to UMLLC's approval rights as set forth herein, and (z) an exclusive right to operate the Utility System (and any expansions, improvements or replacements thereto) and to provide Utility Services on the University Campus (except as expressly provided herein), and in connection therewith (A) to use, possess, control, operate, manage, modify, maintain, and rehabilitate the Utility System; and (B) to charge the Utility Fee (collectively, the "Transaction").

Section 2.2. Turnover.

- (a) The commencement of the rights and obligations of the Parties hereunder (the "Turnover") shall occur on the date on which the Turnover occurs which date shall be the date hereof (the "Turnover Date"). The Turnover shall be held at the University, [●], Baton Rouge, Louisiana, or such other place agreed to in writing by UMLLC and the Concessionaire.
- (b) All Prorated Items shall be prorated between UMLLC and the Concessionaire as of 11:59 p.m. on the Day immediately preceding the Turnover Date based upon the actual number of Days in the month and a three hundred sixty-five (365) -Day year and the required payment resulting from such proration shall be made by the relevant Party to the other as follows:
 - (i) On or prior to the Time of Turnover, UMLLC will provide to the Concessionaire an itemized statement of such Prorated Items, estimated in good faith as of the Turnover and reasonably based on relevant billing information from third parties or (in the absence of such information) UMLLC's or the University's financial statements as of [●], and such statement shall be the basis of proration of any Prorated Items at the Time of Turnover;
 - (ii) Within forty-five (45) Business Days after the Turnover, UMLLC will provide to the Concessionaire a revised good-faith accounting of such Prorated Items as of the Turnover in the form of an itemized statement of such Prorated Items (the "Revised Proration Statement");
 - (iii) Within fifteen (15) Business Days after the Concessionaire's receipt of the Revised Proration Statement, the Concessionaire will review the Revised Proration Statement and will notify UMLLC of any adjustments made by the Concessionaire to the Revised Proration Statement in good faith;
 - (iv) To the extent UMLLC disagrees with any of the Concessionaire's adjustments to the Revised Proration Statement, UMLLC shall provide notice to the Concessionaire within fifteen (15) Business Days after

UMLLC's receipt of the Concessionaire's adjustments, and any disagreement shall be resolved in accordance with Article 18; and

- (v) Upon final resolution with respect to the proration of each such Prorated Item (whether by agreement of the Parties or in accordance with Article 18), the Party that is determined to owe money pursuant to the proration of that Prorated Item shall pay to the other party the amount owed within ten (10) Business Days of such determination.
- (c) At the time of the first closing of the Concessionaire's financing of the Initial Modernization Project, the Concessionaire shall pay to the University in readily available funds (according to instructions provided by the University to the Concessionaire not later than three (3) Days prior to such closing) an amount equal to the University Reimbursable Amount.

Section 2.3. Conditions Precedent to Turnover.

- (a) *Conditions for the Benefit of the Concessionaire.* The Concessionaire shall be obligated to complete the Turnover only if each of the following conditions has been satisfied in full at or before the Time of Turnover, unless waived by the Concessionaire:
 - (i) the representations and warranties of UMLLC set forth in Section 9.1 shall be true and correct in all material respects as of the Time of Turnover;
 - (ii) UMLLC shall have (A) delivered to the Concessionaire a legal opinion of counsel to UMLLC, substantially in the form attached hereto as Schedule 8A, and (B) executed and delivered the Employee Services Agreement in the form of Schedule 4B (which shall also have been executed by the University);
 - (iii) all Campus-Wide Permits set forth on Schedule 18 are in full force and effect;
 - (iv) UMLLC shall have obtained and delivered to the Concessionaire, at the expense of the Concessionaire, a commitment effective at the Time of Turnover for a leasehold title policy or policies, in form and substance reasonably acceptable to the Concessionaire (which will include an endorsement with the terms of the leasehold coverage), proposing to insure the leasehold interest of the Concessionaire in the Utility System Land, to the extent of such leasehold interest, subject only to (A) Permitted UMLLC Encumbrances, (B) Permitted Concessionaire Encumbrances (other than the Permitted Concessionaire Encumbrances specified in clause (iv), clause (vii), and clause (ix) of the definition of "Permitted Concessionaire Encumbrances" as it pertains to clause (iv) of this Section 2.3(a)) and (C) any Encumbrances the Concessionaire is required to remove pursuant to Section 3.5(a) (the "Title Commitment") from the Title Company, from which Title Company the Concessionaire shall purchase any leasehold title

insurance policies (or any other title policies related to the Transaction) that it elects to purchase at Concessionaire's cost in connection with the Transaction or any Leasehold Mortgage; and

- (v) UMLLC shall have delivered to the Concessionaire a certificate confirming that each of the conditions set forth in Section 2.3(a)(i) through Section 2.3(a)(iv) has been satisfied in full by UMLLC (except for any condition that has been waived by the Concessionaire) at or before the Time of Turnover.
- (b) *Conditions for the Benefit of UMLLC.* UMLLC shall be obligated to complete the Turnover only if each of the following conditions precedent has been satisfied in full at or before the Time of Turnover, unless waived by UMLLC:
- (i) the representations and warranties of the Concessionaire set forth in Section 9.2 shall be true and correct in all material as of the Time of Turnover;
 - (ii) the Concessionaire shall have (A) delivered to UMLLC a legal opinion of outside counsel to the Concessionaire, substantially in the form attached hereto as Schedule 8B, and (B) executed and delivered the Employee Services Agreement;
 - (iii) the Concessionaire shall have delivered to UMLLC a certificate confirming that the Concessionaire has engaged TEP as the IMP Contractor to perform substantially all of the Initial Modernization Project pursuant to the Drop-Down DB Contract; and
 - (iv) the Concessionaire shall have delivered to UMLLC a certificate confirming that each of the conditions set forth in Section 2.4(b)(i) through Section 2.4(b)(iii) has been satisfied in full by UMLLC (except for any condition that has been waived by UMLLC) at or before the Time of Turnover.
- (c) *Mutual Conditions.* In addition, UMLLC and the Concessionaire shall be obligated to complete the Turnover only if each of the following conditions precedent has been satisfied in full at the Time of Turnover, unless waived by both UMLLC and the Concessionaire:
- (i) there shall be no preliminary or permanent injunction or temporary restraining order or other order issued by a Governmental Authority of competent jurisdiction or other legal restraint or prohibition enjoining or preventing the consummation of the Transaction;
 - (ii) there shall be no action taken, or any Law enacted, entered, enforced or deemed applicable to the Transaction by any Governmental Authority of competent jurisdiction that, in any such case, has resulted or (in the case of any pending review or proceeding, if adversely determined) could reasonably be expected to result in such Governmental Authority conditioning or restricting the consummation of the Transaction in a manner

that would impose a material impairment on the Transaction or make the consummation of the Transaction illegal; and

- (iii) UMLLC and the Concessionaire shall have approved in writing the Preliminary Design for the Initial Modernization Project in the form of Schedule 7 (which shall also have been approved in writing by the University).

Section 2.4. Covenants.

- (a) *Cooperation.* The Parties shall cooperate with each other in consummate the Transaction as provided in this Agreement.
- (b) *Reasonable Efforts.* Each Party shall use all reasonable efforts (i) to take, or cause to be taken, all actions necessary to comply promptly with all requirements under this Agreement and all legal requirements which may be imposed on such Party to consummate the Transaction as promptly as practicable, including making any necessary filings, and (ii) to obtain (and to cooperate with the other Party to obtain) any Consent of any Governmental Authority or any other public or private third party which is required to be obtained or made by such Party in connection with the consummation of the Transaction. Each Party shall promptly cooperate with and promptly furnish information to the other Party at such other Party's reasonable request in connection with any such efforts by, or requirement imposed upon, any of them in connection with the foregoing.
- (c) *Injunctions.* If any Governmental Authority of competent jurisdiction issues a preliminary or permanent injunction or temporary restraining order or other order which would prohibit or materially restrict or hinder the Transaction, each Party shall use all reasonable efforts to have such injunction, decree or order dissolved or otherwise eliminated or to eliminate the condition that formed the basis for such injunction or order, in each case as promptly as possible.
- (d) *Operation of the Utility System After the Time of Turnover.* The Concessionaire shall be fully responsible for performing the Utility Services under the terms of this Agreement, and for observing and performing all other obligations of the Concessionaire hereunder, from and after the Time of Turnover.
- (e) *Access to Information and Inspections.* The Concessionaire shall hold and shall cause its Representatives to hold in strict confidence all Documents and information concerning the Utility System to the extent and in accordance with the terms and conditions of the confidentiality agreement between UMLLC and the Concessionaire in connection with the Transaction. The Concessionaire shall, at the request of UMLLC, in connection with claims or actions brought by or against third parties based upon events or circumstances concerning the Utility System, (A) provide reasonable assistance in the collection of information or Documents and (B) make the Concessionaire's employees available when reasonably requested by UMLLC; *provided, however*, that UMLLC shall reimburse the Concessionaire for

all out-of-pocket and documented costs and expenses incurred by the Concessionaire in providing said assistance and will not unduly interfere with the Concessionaire's operations.

(f) *Final Design of Initial Modernization Project; Approved Budgeted Amount.* As quickly and efficiently as reasonably possible after the date hereof, the Parties shall cooperate and work collaboratively with each other and the University to develop and approve (x) the Final Design of the Initial Modernization Project based on the Preliminary Design and (y) the proposed Approved Budgeted Amount for the Initial Modernization Project (which shall include the University Reimbursable Amount plus the Concessionaire Cost of Finance); *provided* the proposed Approved Budgeted Amount for the Initial Modernization Project shall not exceed [(\$111,880,557)] (such amount, plus the Concessionaire Cost of Finance, the "Maximum Budgeted IMP Amount"). The Concessionaire shall have the right to request Approval of the Final Design and the Approved Budgeted Amount for the Initial Modernization Project at any time, which UMLLC shall consider in good faith, by submitting a request to UMLLC, or an office or person designated by UMLLC Liaison, containing detailed plans for the Final Design and the proposed Approved Budgeted Amount based on such detailed plans, which shall include, in addition to such other commercially reasonable detail as UMLLC shall require (which may include, at UMLLC's discretion, such information and detail as contemplated by Section 4.3 below as if the Initial Modernization Project were a Capital Improvement or Material Change contemplated thereby): (A) total costs for construction and installation of the Initial Modernization Project, including all hard and soft costs, any financing costs, and any applicable sales or use tax, which shall be presented on an Open Book Basis; (B) an explanation of all relevant assumptions, variables, and data sources used to develop the proposed Final Design and the proposed Approved Budgeted Amount; and (C) the proposed schedules, process, and other technical and logistics details associated with the proposed Final Design and the proposed Approved Budgeted Amount. Upon receipt of the Concessionaire's request for approval of the Final Design and the Approved Budgeted Amount for the Initial Modernization Project, including all supporting information and detail therefor as described in this Section 2.4(f), UMLLC shall review such request and, in its discretion:

- (i) Approve such request in accordance with the terms of such request after having undertaken all such necessary action and secured all authorizations, consents, and approvals required to be obtained by UMLLC with respect to such Approval at such time, unless the Concessionaire's written request submitted to UMLLC explicitly requested that UMLLC respond only pursuant to Sections 2.4(f)(ii) or (iii);
- (ii) provide a written response requiring that the Concessionaire (1) perform additional work with respect to such proposed Final Design to provide further information regarding the scope, design, or cost thereof and/or multiple alternative designs therefor to UMLLC, which additional work may include procuring any details contemplated by this Section 2.4(f) that

were previously unavailable, and (2) after performing such additional work, submit a revised request for Approval by UMLLC pursuant to this Section 2.4(f), which revised request UMLLC shall consider; or

- (iii) (1) provide the Concessionaire with comments on such proposed Final Design or such proposed Approved Budgeted Amount, as applicable, including comments on any details provided in the Concessionaire's proposal, and (2) require that the Concessionaire incorporate such comments and re-submit a revised request for Approval pursuant to this Section 2.4(f).

The foregoing submittal and approval process shall continue until such time as the proposed Final Design and the proposed Approved Budgeted Amount has been Approved in accordance with Section 2.4(f)(i) above. Following UMLLC's approval of the proposed Approved Budgeted Amount in accordance with this Section 2.4(f), such amount shall constitute the Approved Budgeted Amount for the Initial Modernization Project, for purposes of this Agreement, including the calculation of the Utility Fee hereunder.

- (g) *Policies of Insurance.* UMLLC and the Concessionaire shall be responsible for obtaining insurance for the Utility System in accordance with the terms hereof.
- (h) *Employees.* The Concessionaire shall interview (or use its reasonable efforts to cause the Operator to interview) each University Utility System Employee individually. If either the Concessionaire or the Operator makes any offer of employment to any such individual, such offer shall contain only the terms and conditions of employment that the Concessionaire or the Operator, as the case may be, deems to be appropriate in its discretion, except that the Concessionaire or the Operator, as the case may be, shall include wages, benefits and other terms and conditions of employment that are at a minimum, comparable to other similarly-situated employees of the Concessionaire or the Operator, as the case may be, reasonably adjusted based upon the metropolitan statistical area of Baton Rouge, Louisiana. Any and all employees of the Concessionaire and the Operator shall have met all reasonable background inspection and security requirements of the University, as promulgated from time to time. With respect to University Utility System Employees who elect to remain a University employee and elect not to become an employee of the Concessionaire, the Concessionaire, UMLLC, and the University shall enter into the Employee Services Agreement pursuant to which the University shall continue to pay all salaries, wages, and benefits of such University Utility System Employees (including payment of employer contributions to the Louisiana State Employees' Retirement System pursuant to La. R.S. 11:441, the Louisiana Deferred Compensation Plan, social security, or other retirement systems, as applicable, for each such University Utility System Employee, in each case meeting the University's employer contribution rate as determined each year by the State) subject to reimbursement from the Concessionaire for all such salaries, wages and benefits. Nothing in this Agreement shall be construed or is otherwise intended to create joint employment by UMLLC or the University and the

Concessionaire and/or the Operator, as the case may be, of the employees of the Concessionaire or the Operator; the Concessionaire or the Operator, as the case may be, shall have the right and obligation to supervise and direct the work of its employees. UMLLC and the Concessionaire agree that the work to be performed by the Concessionaire and/or the Operator pursuant to or as a result of this Agreement is part of the trade, business, or occupation of UMLLC and is an integral part of and essential to the ability of UMLLC to generate its goods, products or services. Accordingly, and in accordance with La. R.S. § 23:1032 and § 23:1061, UMLLC shall be considered the statutory employer of the Concessionaire's and/or the Operator's, and their respective Representative's employees who perform part of the Utility Services or provide services in connection with or as a result of this Agreement, and the Concessionaire the Operator shall require their Representatives to agree that UMLLC shall be considered the statutory employer of such Representative's employees who perform work or provide services in connection with or as a result of this Agreement. It is the express intention of UMLLC and the Concessionaire and/or the Operator that UMLLC, as the statutory employer, shall, in accordance with La. R.S. 23:1061, be granted the exclusive remedy protections of La. R.S. 23:1032. In the event UMLLC is required as the statutory employer to pay any amounts, including any workers' compensation benefits, to any of the Concessionaire's and/or the Operator's, and their respective Representative's employees who perform part of the Utility Services in connection with or as a result of this Agreement, it shall be entitled to indemnity from the Concessionaire and/or the Operator for such payments.

- (i) *Excluded Utility System Projects.* UMLLC shall undertake the construction of the Excluded Utility System Projects, in accordance with applicable Law, until they have been completed in substantial accordance with the plans for such Excluded Utility System Projects, provided that UMLLC may, upon written notice to the Concessionaire, abandon or modify any or all Excluded Utility System Projects. To the extent that the construction or completion of any Excluded Utility System Project requires access to the Utility System, the Concessionaire hereby grants a non-exclusive license to UMLLC and its Representatives to so access the Utility System as necessary to complete such Excluded Utility System Projects (and UMLLC shall use reasonable efforts to avoid undue interference with the operation of the Utility System) and shall reasonably cooperate with UMLLC and its Representatives with respect to the completion of the Excluded Utility System Projects, which cooperation shall include (i) providing UMLLC with notice if the Concessionaire becomes aware of any deviation from UMLLC's approved plans and specifications for the applicable Excluded Utility System Project and (ii) directing UMLLC's Contractors to stop any work on the Excluded Utility System Project if the Concessionaire reasonably believes that continuing such work would constitute an Emergency. Upon completion of an Excluded Utility System Project, UMLLC shall (i) deliver the Concessionaire written notice thereof, and, at such time, that Excluded Utility System Project shall become part of the Utility System and the Concessionaire shall be granted a leasehold interest therein, (ii) either (A) assign to the Concessionaire (or one or more third parties at the Concessionaire's direction,) all contractors' warranties held by UMLLC with respect to such

Excluded Utility System Project or (B) to the extent UMLLC chooses not to so assign such warranties or such warranties are not assignable, cooperate with the Concessionaire to provide the benefit of such warranties to the Concessionaire (or one or more third parties at the Concessionaire's direction), and (iii) the Capped O&M Amount shall be increased for the Fiscal Year in which such Excluded Utility System Project is placed into service by the additional annual operation and maintenance costs (determined reasonably in accordance with GAAP) that the Concessionaire is required to incur due to the placement into service of such Excluded Utility System Project, provided that the Concessionaire provides reasonable proof of such additional costs and that such additional costs were unavoidable. UMLLC shall name the Concessionaire as an additional insured on its insurance policies with respect to those Excluded Utility System Projects. For the avoidance of doubt, Excluded Utility System Projects shall not be considered New Approved Capital Improvements. If UMLLC elects to abandon an Excluded Utility System Project, the Capped O&M Amount shall be increased for the Fiscal Year in which such Capital Improvement is abandoned by the additional annual operation and maintenance costs (determined reasonably in accordance with GAAP) that the Concessionaire is required to incur due to the abandonment of such Excluded Utility System Project, provided the Concessionaire provides reasonable proof of such additional costs and that such additional costs were unavoidable.

Section 2.5. Turnover Deliverables. At the Time of Turnover, each Party shall execute and deliver all assets, agreements, endorsements, instruments, and Documents as are reasonably necessary in the opinion of the other Party to effect the Transaction (and in form and substance that are reasonably satisfactory to such other Party).

Section 2.6. Memorandum of Sub-Lease. At the Time of Turnover, the Parties shall execute and deliver a Memorandum of Sub-Lease (the "Memorandum of Sub-Lease") in the form attached hereto as Schedule 13, which the Concessionaire shall cause to be recorded in the Recorder's Office of the East Baton Rouge Parish, Louisiana. To the extent that changes are made to this Agreement with respect to the Term, leased property or other material matters set forth in the recorded Memorandum of Sub-Lease, including the removal of property from service by the Utility System in accordance with Section 5.3, the Parties shall timely (and in no event longer than 10 Days after a request therefor) execute, deliver and record an amendment to the recorded Memorandum of Sub-Lease reflecting such changes. The Parties acknowledge that for purposes of recordation, a description of certain portions of the Utility System constituting Utility Facilities that are a real property interest, are depicted specifically but are recorded generally against the lot or parcel on which such Utility Facility is located. Each party shall have the right, from time to time, at its cost and expense to further refine by a metes and bounds legal description the specific location of the applicable Utility Facility, and subject to the other Parties' reasonable approval, may modify the Memorandum of Sub-Lease by recording an amendment thereto that shows the refined location description. In such instance, the modification to the Memorandum of Sub-Lease is subject to the other Party's reasonable approval, and both Parties shall sign a consent to the recording of the Memorandum of Sub-Lease upon its approval. The Parties agree not to record this Agreement itself.

ARTICLE 3
TERMS OF THE CONCESSION

Section 3.1. Quiet Enjoyment and Present Condition.

- (a) *Quiet Enjoyment.* UMLLC agrees that, subject to UMLLC's remedies upon a Concessionaire Default, the Concessionaire shall, at all times during the Term, be entitled to and shall have quiet enjoyment of the Utility System and the rights and privileges granted to the Concessionaire hereunder, subject to the provisions contained in this Agreement. UMLLC and the Concessionaire acknowledge that the Concessionaire's rights to use, control, and possess the Utility System and to collect and retain the Utility Fee are subject to the right of UMLLC, in accordance with the terms of this Agreement, to monitor compliance with this Agreement to ensure that the Utility System is used and operated as required by this Agreement. Any entry by UMLLC or its Representatives into the Utility System required or permitted under this Agreement shall not constitute a reentry, trespass, or a breach of the covenant for quiet enjoyment contained in this Agreement. UMLLC shall, at all times during the Term, defend its fee or leasehold interest title, as the case may be, to the Utility System, the Concessionaire's leasehold interest in and to the Utility System and the rights granted to the Concessionaire hereunder, or any portion thereof, against any Person claiming any interest adverse to UMLLC or the Concessionaire in the Utility System, or any portion thereof, except where such adverse interest arises as a result of the act, omission, negligence, or willful misconduct of, or violation of applicable Law by, the Concessionaire, its Affiliates or their respective Representatives.
- (b) *Present Condition.* Subject to Section 2.4(g) and except as specifically set forth herein, the Concessionaire understands, agrees, and acknowledges that the Concessionaire (i) by the execution of this Agreement, agrees to accept the Utility System "AS IS" at the Time of Turnover and (ii) has inspected the Utility System and is aware of its condition and acknowledges that UMLLC neither has made nor is making any representation or warranty, other than as expressly set forth herein, express or implied, regarding the condition of the Utility System (or any part thereof), the absence of latent or apparent defects in the Utility System (or any part thereof), or its suitability for the Concessionaire's proposed use, provided that nothing in this Section 3.1(b) shall preclude the Concessionaire from making repairs or replacements or Capital Improvements to the Utility System in accordance with the terms of this Agreement (including, for the avoidance of doubt, the provisions regarding Approval of Capital Improvements set forth in Section 4.3 and the provisions regarding inclusion of New Approved Capital Improvements and operations and maintenance costs (reasonably determined in accordance with GAAP) in the calculation of the Utility Fee in accordance with Schedule 5) as a result of the Utility System's condition at the Time of Turnover. Upon the Turnover, the Concessionaire shall be deemed to have inspected and shall assume responsibility for the condition of the Utility System consistent with provisions of La R.S. 9:3221.

- (c) *Legal Title to Real Property and Improvements.* For the avoidance of doubt, and notwithstanding anything to the contrary contained herein, all real estate and improvements now or hereafter forming part of the Utility System shall be the fee-owned property of the University for GAAP and State law purposes, and are subject to the terms and conditions of this Agreement.

Section 3.2. Utility System Operations.

- (a) *Use.* Except as otherwise specifically provided herein, the Concessionaire shall, at all times during the Term, (i) be responsible for all aspects of the Utility System Operations, including providing the Utilities from temporary sources for construction projects and special events as identified by UMLLC and (ii) maintain and operate the Utility System and cause the Utility System Operations to be performed in accordance with the provisions of this Agreement, including the Performance Standards, Prudent Industry Practices, and applicable Law. Upon UMLLC's request, the Concessionaire shall provide an estimate for the costs associated with providing Utilities from temporary sources for construction projects or special events identified by UMLLC. In connection with such maintenance, the Concessionaire may contract with a third party for certain tasks, such as janitorial services. Except for such additional purposes permitted pursuant to Section 3.15(c), the Concessionaire shall, at all times during the Term, cause the Utility System to be used exclusively for the Utility System Purposes and continuously open and operational for the Utility System Purposes in accordance with the Performance Standards. Notwithstanding the foregoing, the Concessionaire may cease keeping the Utility System or a portion thereof continuously open and operational for the Utility System Purposes (A) as specifically permitted under this Agreement, (B) as required by applicable Law, (C) as necessary to comply with any other requirement of this Agreement (including closures related to the performance of Capital Improvements or maintenance or repair activities as required by the Performance Standards), (D) as necessary for a Delay Event, or (E) as necessary for temporary closures required to address Emergencies or public safety; provided, however, that in the event of any temporary suspension of Utility System Operations pursuant to any of clauses (A) through (E) of this Section 3.2(a), such suspension shall be limited as much as practicable so as to allow all other Utility System Operations to continue.
- (b) *University Campus.* Notwithstanding anything to the contrary contained herein, the Concessionaire shall operate the Utility System and provide the Utility Services in a manner that does not interfere with or impair the operation of the University Campus or any other real property owned by UMLLC, including any special events conducted on the University Campus. Except in the case of an Emergency or as otherwise provided for in Section 3.2(e) or Section 3.2(j), if the Concessionaire, in performing the Utility System Operations, determines it is reasonably necessary to access or disturb any portion of the University Campus or any other real property owned by the University or UMLLC, excluding Utility System Land, it shall, to the extent possible given the circumstances, provide UMLLC at least thirty (30) Days' prior written notice and the Concessionaire shall comply with any reasonable

requirements or restrictions on such disturbance imposed by UMLLC, including limiting the time in which the Concessionaire can so access and/or disturb the portion of the University Campus or any other real property owned by the University or UMLLC to specific hours. In accessing any portion of the University Campus or any other real property owned by the University or UMLLC pursuant to the license granted hereunder, the Concessionaire shall also abide by any restrictions and requirements generally imposed by UMLLC on such access, as communicated to the Concessionaire from time to time. To the extent that, in operating and maintaining the Utility System, the Concessionaire damages any portion of the University's or UMLLC's real or personal property, including the landscape of the University Campus, the University's or UMLLC's information technology network or any other real property owned by the University or UMLLC, the University's or UMLLC's outdoor lighting, traffic signals, irrigation equipment and communications equipment and such damage was neither (i) Approved by UMLLC in accordance with this Agreement nor (ii) included as part of the scope of work Approved by UMLLC related to such operations and maintenance, then the Concessionaire shall, in coordination with UMLLC personnel, promptly cause such property to be repaired to substantially the same or, solely at the Concessionaire's election, better condition that existed prior to such damage, and the cost incurred therewith shall not be recovered as a part of the Utility Fee or otherwise provided, however, that the Concessionaire shall be entitled to make a claim on any applicable Concessionaire Required Coverage.

- (c) *Costs and Expenses.* Except as otherwise specifically provided herein, the Concessionaire shall, at all times during the Term, pay or cause to be paid all costs and expenses of the Utility System Operations as and when the same are due and payable.
- (d) *Assumed Liabilities and Excluded Liabilities.* The Concessionaire agrees to assume and discharge or perform when due all debts, liabilities, and obligations whatsoever relating to the Utility System or the Utility System Operations that occur, arise out of or relate to, or are based on facts or actions occurring during the Term but only to the extent such debts, liabilities, or obligations do not arise from or relate to any breach by UMLLC of any covenant, representation, or warranty set forth in this Agreement (collectively, the "Assumed Liabilities"); *provided, however*, that the Assumed Liabilities shall not include, and UMLLC shall perform or cause to be performed and discharge or cause to be discharged as and when due, any debts, liabilities, and obligations (i) with respect to UMLLC's obligations under this Agreement, (ii) arising out of the Utility System or any Utility System Operations (including with respect to any Utility System Employee) prior to the Time of Turnover, (iii) arising under any Environmental Law and related to (1) the ownership, operation or condition of the Utility System prior to the Time of Turnover or (2) the Release on or from, presence on or in, or other existence on the Utility System or its subsurface of any Hazardous Substance at any time prior to the Time of Turnover and including (A) the abatement, handling, disposal, or removal of any asbestos or other Hazardous Substances present at the Time of Turnover in the Utility System as required by any Environmental Law in

connection with the repair, maintenance, operation, or construction activities permitted or required to be performed under this Agreement and (B) any known or unknown environmental conditions relating to the Utility System or its subsurface that existed prior to the Time of Turnover the manifestation of which occurs following the Time of Turnover, which environmental obligations UMLLC shall perform and discharge when due, except in any case to the extent exacerbated by the Concessionaire or its Representatives or caused by any action of the Concessionaire or its Representatives, (iv) arising out of UMLLC's rights under this Agreement to test, inspect, audit, repair, maintain, or operate the Utility System without impairment of UMLLC's remedies for a Concessionaire Default and (v) with respect to the Excluded Utility System Projects that have not yet become a part of the Utility System in accordance herewith (collectively, the "Excluded Liabilities").

- (e) *Right of Entry and Access to the Public Way.* Subject to Section 3.19, UMLLC hereby grants to the Concessionaire and its Representatives a non-exclusive license to enter upon, in, under, over, and across the Public Way to such extent and at such times as shall be necessary or desirable for the Concessionaire to access the Utility System in order to conduct Utility System Operations, including operating, maintaining, inspecting, repairing, and managing Utility System properties, including the Utility System Assets and all supporting structures and appurtenances thereto, and installing monitoring or observation technology or equipment reasonably necessary for Utility System Operations. The rights granted pursuant to this Section 3.2(e) do not include the right to block, impede, or otherwise obstruct traffic on the Public Way, and the Concessionaire shall, enter, access, and perform work in, on or over the Public Way in accordance with the Performance Standards. The rights granted to the Concessionaire under this Section 3.2(e) neither create an interest in real property nor do they create a priority in favor of the Concessionaire over any other user of such areas and are subject to the Performance Standards and all provisions of Law relating to the conduct of a private business or franchise in the Public Way.
- (f) *Mapping and Marking.* The Concessionaire shall be responsible for marking and mapping all portions of the Utility System in accordance with the Performance Standards.
- (g) *Deemed Planned Outage.* The Concessionaire shall have the right to propose to shut down a portion of the Utility System such that such portion shall not transmit Utilities provided by that portion of the Utility System if the Concessionaire reasonably believes that such a shutdown will avoid additional costs in excess of the costs of such shutdown or lengthier shutdowns of the Utility System or a portion thereof later. If UMLLC Liaison agrees to such shut down (which agreement must be in writing or by e-mail from UMLLC Liaison), then it shall be treated as a Planned Outage. UMLLC Liaison shall consider such proposed shut down in good faith. If UMLLC Liaison does not Approve such shutdown, then it will be considered an Unplanned Outage if the Concessionaire elects to proceed with such shutdown.

- (h) *Emergency Shutdown.* If there is a circumstance where the continued operation of a portion of the Utility System creates an Emergency (other than an Unplanned Outage), then the Concessionaire shall have the right, directly or through its automatic protection system or the Operator, to shut down the applicable portion of the Utility System to address such circumstance, provided that the Concessionaire shall comply with the provisions of Section 8.1 and the relevant portion of the Performance Standards, as if such shutdown were an Unplanned Outage. The Concessionaire shall perform the corrective action to address such circumstance as soon as reasonably practicable. Within ten (10) Business Days after the shutdown and repair of the applicable portion of the Utility System, the Concessionaire shall provide UMLLC with pertinent information on such circumstance and such other relevant information within the Concessionaire's possession or control that is requested by UMLLC, and UMLLC shall determine, in its reasonable judgment, whether such shutdown shall constitute an Unplanned Outage for purposes of determining the applicable Key Performance Indicator. For the avoidance of doubt, such determination shall not affect the Concessionaire's obligation to treat such shutdown as an Unplanned Outage for purposes of compliance with the Performance Standards.
- (i) *Other Public Streets.* To the extent that the performance of the Utility System Operations requires access to streets, alleys, driveways, or sidewalks owned or controlled by a Governmental Authority, UMLLC shall, at no out-of-pocket cost to UMLLC, use commercially reasonable efforts to cooperate, and cause the University to cooperate, with the Concessionaire to secure such access from the applicable Governmental Authority consistent with UMLLC's and the University's past practice.

Section 3.3. Operator.

- (a) *Engagement.* The Utility System Operations shall, at all times during the Term, be under the direction and supervision of an active operator with the expertise, qualifications, experience, competence, skills, and know-how to perform the Utility System Operations in accordance with this Agreement, Prudent Industry Practices and applicable Law (an "Operator") who may be (but is not required to be) the Concessionaire itself. The Operator on the first Day of the Term shall be [CenTrio Energy South LLC] unless the Concessionaire has designated another Person to be the Operator and such Person has been Approved in accordance with Section 3.3(b). The Concessionaire shall not engage or appoint a replacement Operator unless UMLLC has Approved such Operator and the terms (including fees charged by such replacement Operator) of any such engagement are commercially reasonable; *provided, however*, that a Change in Control of an Operator shall be deemed to be the appointment of a replacement Operator subject to UMLLC's Approval; *provided, further*, that for purposes of this Section 3.3(a), the definition of "Equity Participant" and clauses (a) through (g) of the definition of "Change in Control" shall be read and apply as though "Operator" were substituted for the "Concessionaire"; *provided, further*, that if UMLLC does not provide the Concessionaire with the relevant Approval, the Concessionaire shall be entitled to

appoint an interim Operator for a period of up to one hundred eighty (180) Days from the date of appointment of such interim Operator. This interim Operator may be selected without Approval by UMLLC so long as the Concessionaire reasonably determines that the interim Operator meets the following criteria: (A) the interim Operator has experience in operating Comparable Utility Systems and (B) the interim Operator (or any guarantor of its obligations) has a tangible net worth reasonably sufficient to carry out its obligations and responsibilities as Operator. The Concessionaire shall not extend the term of any interim Operator beyond one hundred eighty (180) consecutive Days or appoint a successor interim Operator after such one hundred eighty (180) -Day period. The Operator shall at all times be subject to the direction, supervision, and control (by ownership, contract, or otherwise) of the Concessionaire, and any delegation to an Operator shall not relieve the Concessionaire of any obligations, duties or liability hereunder. The Concessionaire shall immediately notify UMLLC upon the termination or resignation of an Operator. The rights of the Operator regarding the continued operation of the Utility System shall terminate without penalty at the election of UMLLC or the Operator upon five (5) Business Days' notice to such Operator or UMLLC, as applicable, upon the termination of this Agreement. Except as otherwise expressly set forth herein, the Operator shall have no interest in, or rights under, this Agreement or the Utility System unless the Operator is the Concessionaire itself.

- (b) *Approval.* UMLLC has the right, acting reasonably, to withhold Approval of any removal of the Operator or a proposed replacement Operator, including for any of the following reasons: (i) UMLLC reasonably determines that the engagement of such proposed Operator is prohibited by applicable Law or this Agreement; or (ii) UMLLC reasonably determines that such proposed Operator is not capable of performing the Utility System Operations in accordance with this Agreement and Prudent Industry Practices, which determination may be based upon one or more of the following factors: (A) the ability of the proposed Operator to operate the Utility System in a manner that complies with the Performance Standards; (B) the financial strength, capitalization, and integrity of the proposed Operator, its direct or indirect beneficial owners and some or all of their respective Affiliates providing a guaranty of the Operator's obligations (which guaranty shall not be required to run to the benefit of UMLLC); (C) the experience of the proposed Operator in operating Comparable Utility Systems; (D) the background and reputation of the proposed Operator, its direct or indirect beneficial owners, each of their respective officers, directors and employees and each of their respective Affiliates (including the absence of criminal, civil or regulatory claims or actions against any such Person and the quality of any such Person's past or present performance on other projects); and (E) the proposed terms of the engagement of the proposed Operator, including the fee being charged by the Operator, length of the term of the engagement and any restrictions on transfer by the Operator of its obligations and change in control of the proposed Operator.
- (c) *Removal.*

- (i) If the Operator fails to operate the Utility System in compliance with the Performance Standards or fails to meet the Target for any Key Performance Indicator, and:

(A) If such failure is the material breach of a material requirement of the Performance Standards other than a requirement that is also a Key Performance Indicator, UMLLC may provide written notice to the Operator and the Concessionaire setting forth such failure. If the Operator does not cure such failure within thirty (30) Days of said written notice (or, if such cure or correction cannot reasonably be accomplished during such thirty (30) -Day period, within such longer period is as reasonably required to accomplish such cure or correction, provided the Concessionaire, either directly or through the Operator, has commenced such cure or correction within thirty (30) Days of said written notice and diligently prosecutes the same to completion), then (i) UMLLC may, upon notice to the Concessionaire (A) cure such failure and (B) the Concessionaire shall reimburse UMLLC any and all costs related to such cure and/or correction; and (ii) UMLLC may direct that the Concessionaire remove the Operator pursuant to the written order of senior UMLLC officials designated by the President of the University (or his or her designee) in writing for such purpose or otherwise with respect to assessing the performance of the Operator (the “Senior Officials”).

(B) If such failure results in an Emergency, then UMLLC may, upon notice to the Concessionaire, (i) immediately cure any such failure after endeavoring to provide the Concessionaire notice appropriate under the circumstances (which may include telephone notice) and (ii) the Concessionaire shall reimburse UMLLC any and all direct costs related to such cure and/or correction.

- (ii) Notwithstanding the foregoing, if:

(A) within any Operator Evaluation Period, at least three (3) Repetitive Failures occur;

(B) a Major KPI Event for the same Key Performance Indicator occurs for five (5) consecutive Fiscal Years;

(C) five (5) Major KPI Events occur in any given Fiscal Year; or

(D) the amount of KPI Compensation (such amount to be calculated without regard to any reduction in KPI Compensation pursuant to Section 15.5(e) or Section 12.11(a)) incurred by the Concessionaire equals or exceeds the maximum amount of annual KPI Compensation for which the Concessionaire may be liable in accordance with Section 15.5 in any two (2) Fiscal Years out of any five (5) consecutive Fiscal Years,

then, in addition to its right to KPI Compensation, UMLLC may direct that the Concessionaire remove the Operator pursuant to the written order of the Senior Officials.

- (iii) UMLLC shall provide the Concessionaire and the Operator with no less than thirty (30) Days' prior written notice of the time, date, place, and subject matter of any meeting of the Senior Officials at which a decision to remove the Operator will be considered, and both the Concessionaire and the Operator shall be afforded a reasonable opportunity to present testimony and evidence at such meeting and to present to the Senior Officials written objections to any proposed removal determination. Any written order of the Senior Officials removing the Operator shall contain written determinations as to the reasons for removal of the Operator. Within thirty (30) Days following the effective date of such decision, the Concessionaire shall (x) provide UMLLC with a transition plan to remove the then current Operator and replace such Operator with either (A) a new Operator that is Approved by UMLLC pursuant to Section 3.3(b), (B) an interim Operator in accordance with Section 3.3(a) or (C) to the extent the Concessionaire was not the removed Operator, the Concessionaire, and then (y) carry out such transition plan within 30 Days following the delivery thereof.
- (iv) For the avoidance of doubt, if there is a dispute as to whether there has been a failure to meet the Performance Standards or the Target for any Key Performance Indicator, such dispute shall be subject to resolution in accordance with Article 18.
- (d) *Sole Remedy*. Other than UMLLC's right to KPI Compensation pursuant to Article 15, notwithstanding anything to the contrary contained herein, UMLLC's right to remove the Operator pursuant to Section 3.3(c) shall constitute the Concessionaire's sole and exclusive liability and UMLLC's sole and exclusive remedy relating to a failure to meet a requirement of the Performance Standards or a KPI Event.

Section 3.4. Authorizations; Qualifications.

- (a) *Compliance*. The Concessionaire shall obtain, comply with, promptly renew and maintain in good standing all Authorizations, and UMLLC shall use commercially reasonable efforts to assist the Concessionaire in obtaining, complying with, renewing, and maintaining in good standing all such Authorizations, including those that UMLLC was not required to obtain in connection with its operation of the Utility System prior to the Time of Turnover. If UMLLC reasonably expects to incur any out-of-pocket costs in connection with providing assistance to the Concessionaire as provided in the preceding sentence, it shall have no obligation to provide such assistance until the Concessionaire commits to the prompt reimbursement of such out-of-pocket costs in writing. Nothing in this Agreement, including Section 2.1, shall be deemed to waive or modify any Authorization required to be obtained by the Concessionaire or any other Person in connection

with the Utility System, the Utility System Operations, or any activities generating the Utility Fee.

- (b) *Qualifications.* The Concessionaire shall, at all times during the Term, maintain in full force and effect its existence and all qualifications necessary to carry on its business pertaining to the Utility System Operations, including all rights, franchises, licenses, privileges, and qualifications required in connection with the Utility System Operations.

Section 3.5. No Encumbrances.

- (a) *By the Concessionaire.* The Concessionaire shall not do any act or thing that will create any Encumbrance (other than a Permitted Concessionaire Encumbrance) against the Utility System and shall promptly remove any Encumbrance (other than a Permitted Concessionaire Encumbrance) against the Utility System, unless the Encumbrance came into existence as a result of an act of or omission by UMLLC, the University, or a Person claiming through either of them which in turn was not caused by an act or omission of the Concessionaire. The Concessionaire shall not be deemed to be in default hereunder if the Concessionaire continuously, diligently and in good faith contests any such Encumbrance, or the validity thereof (or causes such contest), by appropriate legal proceedings that shall operate to prevent the foreclosure of any such Encumbrance; provided that the Concessionaire has (i) given advance notification to UMLLC that it is the intent of the Concessionaire to contest the validity or collection thereof or cause such contest and (ii) unless a bond or other security is provided in connection with such proceedings, given a satisfactory indemnity to UMLLC or deposited with UMLLC a Letter of Credit, indemnity bond, surety bond, cash, or Eligible Investment reasonably satisfactory to UMLLC in an amount equal to the amount of the claim or Encumbrance, plus such interest and penalties, court costs, or other charges as UMLLC may reasonably estimate to be payable by the Concessionaire at the conclusion of such contest or as is required to provide insurance over any potential Encumbrance; *provided, however,* that unless the Concessionaire is required by GAAP to maintain any security in favor of a purported beneficiary of such Encumbrance, in the event such Letter of Credit bond, cash or Eligible Investment shall be so deposited, the same shall be held by UMLLC until such claim or other imposition shall have been released and discharged and shall thereupon be promptly returned to the Concessionaire, less any amounts reasonably expended by UMLLC to procure such release or discharge or any loss, cost, damage, reasonable attorneys' fees or expense incurred by UMLLC by virtue of the contest of such Encumbrance.
- (b) *By UMLLC.* UMLLC shall not do any act or thing that will create any Encumbrance (other than a Permitted UMLLC Encumbrance) against the Utility System (and UMLLC shall cause the University not to do any act or thing that will create any Encumbrance (other than a Permitted UMLLC Encumbrance)) and shall promptly remove any Encumbrance (other than a Permitted UMLLC Encumbrance) against the Utility System that came into existence as a result of an act of or omission by UMLLC or the University or a Person claiming through either of them. UMLLC

shall not be deemed to be in default hereunder if UMLLC continuously, diligently, and in good faith contests any such Encumbrance, or the validity thereof (or causes such contest), by appropriate legal proceedings that shall operate to prevent the foreclosure of any such Encumbrance; provided that UMLLC has given advance notification to the Concessionaire that it is the intent of UMLLC to contest the validity or collection thereof or cause such contest.

- (c) *Removal.* Each Party, if requested by the other Party and at such other Party's costs and expense, shall use its reasonable efforts to assist such other Party in attempting to remove any Encumbrance that has come into existence as a result of an act of or omission by such other Party (other than a Permitted UMLLC Encumbrance or a Permitted Concessionaire Encumbrance); *provided* that nothing herein shall obligate UMLLC to waive, modify, or otherwise limit or affect the enforcement by UMLLC of any applicable rule, procedure or policy of UMLLC whether or not with respect to the Utility System.

Section 3.6. Single Purpose Covenants. Subject to Section 3.15(c), the Concessionaire shall, at all times during the Term: (i) be formed and organized solely for the purpose of (A) owning the Concessionaire Interest, (B) owning, leasing, operating, improving, using, possessing, controlling, and otherwise dealing with the Utility System, (C) collecting from UMLLC the Utility Fee in consideration of providing the services hereunder to UMLLC and any fees from third parties to which it provides services to the extent permitted by Section 3.15(c), (D) financing its interest in the Utility System, and (E) carrying out the Utility Services and other activities permitted pursuant to this Agreement (and any activities reasonably incidental thereto); (ii) not engage in any business unrelated to clause (i) above; (iii) not have any assets other than those related to its activities in accordance with clauses (i) and (ii) above; (iv) except as appropriate for Tax reporting purposes, maintain its own separate books and records and its own accounts; (v) observe all corporate, limited partnership or limited liability company, as applicable, formalities and do all things necessary to preserve its existence; (vi) not guarantee or otherwise obligate itself with respect to the debts of any other Person; (vii) except as expressly permitted hereby or by any Leasehold Mortgage, or in the ordinary course of business of the Utility System, not pledge its assets for the benefit of any other Person; and (viii) maintain adequate capital in light of its contemplated business operations.

Section 3.7. Rights of UMLLC to Access and Perform Work on the Utility System and Utilize Space for Energy Resources and Research Purposes.

- (a) *Reservation of Rights.* UMLLC reserves (for itself and the University and any of their respective Representatives, grantees, tenants, contractors, mortgagees, licensees, concessionaires, and others claiming by, through, or under UMLLC or the University) and shall, at all times during the Term, have the right to enter the Utility Facilities and have access to the Utility System in response to any of the following events or circumstances or for any of the following purposes, *provided* that (x) with respect to Section 3.7(a)(i) and Section 3.7(a)(ii), such right is to be exercised at all reasonable times upon reasonable prior notice to the Concessionaire, (y) with respect to Section 3.7(a)(iii), such right is to be exercised at all reasonable times upon reasonable prior notice to the Concessionaire if

practicable under the circumstances, and (z) with respect to Section 3.7(a)(iv), Section 3.7(a)(v), Section 3.7(a)(vi), and Section 3.7(a)(vii) such right is to be exercised at all reasonable times with UMLLC to request, with reasonable prior notice, the Concessionaire's consent to the exercise of such right, which consent shall not be unreasonably withheld, conditioned or delayed, provided that if the Concessionaire has not responded to such request within five (5) Business Days, it shall be deemed to have consented to such exercise:

- (i) to inspect the Utility System, including performance of an assessment of the condition of the Utility System or any component thereof, or determine whether or not the Concessionaire is in compliance with its obligations under this Agreement or applicable Law pursuant to Section 8.3;
- (ii) if a Concessionaire Default then exists, subject to the cure rights of any Leasehold Mortgagee under Section 19.3, to make any necessary repairs to the Utility System and perform any work therein pursuant to Section 16.1(b)(iii) in accordance with Prudent Industry Practices;
- (iii) in the event of an Emergency or danger that threatens to cause injury to individuals (or damage to property) or to materially impair the continuous operation of the Utility System and if the Concessionaire is not then taking all necessary steps to rectify or deal with said Emergency or danger, to take actions as may be reasonably necessary to rectify such Emergency or danger in accordance with Prudent Industry Practices, in which event UMLLC shall promptly give the Concessionaire written notice of such measures taken by UMLLC;
- (iv) at its own cost and expense, to (A) install, design, manage, maintain, repair, and rehabilitate any existing or future safety measures for the University Campus (whether provided by UMLLC or third parties at UMLLC's instruction) in, on, under, across, over, or through the Utility System (including surveillance equipment and other safety equipment), (B) grant easements and rights on, over, under, or within the Utility System for the benefit of suppliers or owners of any such measures, and (C) use the Utility System in connection with any such installation, design, management, maintenance, repair, or rehabilitation (provided that notwithstanding the foregoing clauses (A), (B), and (C), the Concessionaire shall have the right, at all times during the Term, to install, design, manage, maintain, repair, and rehabilitate safety measures for its own account (and not for lease, resale, or service to third parties) to the extent that the said safety measures are necessary for the Utility System Operations or as otherwise permitted under this Agreement);
- (v) at its own cost and expense, to (A) install, design, manage, maintain, repair, and rehabilitate any existing or future utilities or similar services (whether provided by UMLLC or third parties at UMLLC's instruction) that are not part of the Utility System and do not provide Utilities in, on, under, across,

over, or through the Utility System (including water lines, sewer lines, fiber optic cable, other communications and other equipment), and (B) grant easements and rights on, over, under, or within the Utility System for the benefit of suppliers or owners of any such utilities or services that are not part of the Utility System (provided that notwithstanding the foregoing clauses (A) and (B), the Concessionaire shall have the right, at all times during the Term, to install, design, manage, maintain, repair and rehabilitate utilities or other services for its own account (and not for lease, resale, or service to third parties) to the extent that the said utilities or services are (x) necessary for the Utility System Operations and (y) not otherwise Excluded Utility System Projects);

- (vi) at its own cost and expense, to (A) design and install any Excluded Utility System Project, and (B) grant easements and rights on, over, under, or within the Utility System for the benefit of contractors with respect to such Excluded Utility System Project; and
- (vii) at its own cost and expense (except as otherwise expressly provided in this Agreement) and solely in accordance with the terms hereof, to do any other act or thing that UMLLC may be obligated to do or have a right to do under this Agreement;

provided, however, that UMLLC shall (A) not be obligated to make any payments to the Concessionaire for such access (other than Concession Compensation to the extent required by the next proviso) and UMLLC shall use reasonable efforts to minimize interference with the Utility System Operations in connection with any entry on the Utility System pursuant to this Section 3.7(a), (B) not have access to any software or other intangibles of the Concessionaire, and (C) comply with the Concessionaire's reasonable safety protocols and requirements to the extent provided in writing in advance to UMLLC; *provided, further*, that any entry into the Utility System pursuant to clauses (v), (vi), or (vii) of this Section 3.7(a) shall be a Compensation Event.

- (b) *Access Rights.* UMLLC and any of its Representatives, grantees, tenants, contractors, mortgagees, licensees, concessionaires, and others claiming by, through, or under UMLLC, during the progress of any work referred to in this Section 3.7 shall have all necessary easement and access rights to the Utility System. To the extent that UMLLC undertakes work or repairs in the Utility System under this Section 3.7 or any other provision of this Agreement, such work or repairs shall be commenced and diligently completed in a good and professional manner, in accordance with any applicable Performance Standards and the Concessionaire's reasonable safety protocols and procedures to the extent provided in writing in advance to UMLLC and in such a manner as not to unreasonably interfere with the Concessionaire's conduct of business in or use of such space.
- (c) *Renewable and Other Energy Resources.* The Concessionaire and UMLLC recognize the value of exploring the use of renewable energy, energy storage, and other energy resources, and, consistent therewith, UMLLC reserves the right to use

portions of the Utility System for the installation, operation, replacement, and repair of energy apparatus, equipment, or improvements, including solar panels as well as collection and distribution facilities in accordance with Prudent Industry Practices and applicable Law. UMLLC shall have the right to install or replace such energy apparatus, equipment, or improvement. Prior to any such installation, UMLLC shall provide the Concessionaire written notice that includes the plans and schedule for completing such installation or replacement or, alternatively, UMLLC may provide the Concessionaire a written notice requiring it to complete such installation or replacement as part of a UMLLC Directive, which notice shall include the plans, specifications, schedule (including the liquidated damages for failure to meet such schedule), and cost therefor. If the Concessionaire is directed to install or replace such energy apparatus, equipment, or improvement, (i) it shall do so in accordance with the terms and conditions of UMLLC's notice and (ii) to the extent such energy apparatus, equipment, or improvement is a Capital Improvement, it shall, to the extent the costs therefor are incurred by the Concessionaire, be deemed to be a Capital Improvement Approved in accordance with Section 4.3(c)(i) (including the budgeted costs and liquidated damages set forth in such notice), and, once installed, shall be deemed part of the Utility System. Any such access contemplated by this Section 3.7(c) shall comply with the access right requirements set forth above in Section 3.7(b). In connection therewith, upon the request of UMLLC, the Concessionaire agrees that it shall cause any such energy apparatus, equipment, or improvement to be connected to, or become part of, the Utility System in a manner that complies with the Concessionaire's reasonable interconnection and generation standards and is in accordance with Prudent Industry Practices and applicable Law, and that the Concessionaire will use any energy resources generated or stored by such apparatus, equipment, or improvement in the operation of the Utility System to the extent such energy is made available for use in the Utility System. To the extent that the Concessionaire incurs costs for such interconnections (including any costs of installation, operation, replacement and repair), such costs shall be Uncapped O&M Costs.

- (d) *Effect of Reservation.* Any reservation of a right by UMLLC and any of its Representatives, grantees, tenants, contractors, mortgagees, licensees, concessionaires, and others claiming by, through, or under UMLLC to enter the Utility System and to make or perform any repairs, alterations, Restoration, or other work in, to, above, or about the Utility System which is the Concessionaire's obligation pursuant to this Agreement, shall not be deemed to (i) impose any obligation on UMLLC to do so, (ii) render UMLLC liable to the Concessionaire or any other Person for the failure to do so, or (iii) relieve the Concessionaire from any obligation to indemnify UMLLC as otherwise provided in this Agreement. Nothing in this Agreement shall impose any duty upon the part of UMLLC to do any work required to be performed by the Concessionaire hereunder and performance of any such work by UMLLC and any of its Representatives, grantees, tenants, contractors, mortgagees, licensees, concessionaires, and others claiming by, through or under UMLLC shall not constitute a waiver of the Concessionaire's default in failing to perform the same. For the avoidance of doubt and notwithstanding any other provision of this Agreement, access to the Utility System

by UMLLC and its staff, students and Representatives shall be subject to and in accordance with the Concessionaire's reasonable access and safety protocols to the extent provided in writing in advance to UMLLC.

- (e) *Energy Research and Education.* The Concessionaire acknowledges that energy research and education is a significant focus of the University. The University and its energy industry research partners recognize the value of conducting applied energy research in real-world settings, and, consistent therewith, UMLLC reserves the right to use portions of the Utility Facilities for the installation, evaluation, testing, operation, and replacement of energy apparatus, equipment, or improvements to serve research and academic purposes. Any such access contemplated by this Section 3.7(e) shall (i) comply with the access right requirements set forth above in Section 3.7(b), (ii) be in accordance with Prudent Industry Practices and applicable Law, and (iii) comply with the Concessionaire's reasonable safety protocols and procedures to the extent provided in writing in advance to UMLLC. In connection therewith, upon the request of UMLLC, the Concessionaire agrees that it shall cooperate and take all reasonable actions to cause any such energy research apparatus, equipment, or improvement to be connected to the Utility Systems, including associated data collection apparatus, equipment, or improvement, in a manner that complies with the Concessionaire's reasonable interconnection standards, provided that, unless disclosure is required by applicable Law, UMLLC shall maintain any information received by UMLLC in connection therewith confidential in accordance with Section 8.2(b) if the Concessionaire has identified such information as a trade secret. The Concessionaire agrees that any intellectual property, including copyrights, patents, trade secrets, and trademarks, created or generated by or related to any of UMLLC's actions under this Section 3.7(e) shall not be considered owned or created by the Concessionaire, notwithstanding that UMLLC or its energy industry research partners may access or use the Utility System with respect thereto, and the Concessionaire shall have no rights with respect thereto unless UMLLC enters into a separate agreement with the Concessionaire granting such rights. To the extent that the Concessionaire incurs costs for such connections, such costs shall be Uncapped O&M Costs. The Concessionaire also acknowledges that as part of UMLLC's research, UMLLC may request information regarding the Utility System, which information shall be provided pursuant to Section 3.12(a).

Section 3.8. Payment of Taxes. The Concessionaire shall pay when due all Taxes payable during the Term in respect of the use of, operations at, occupancy of, or conduct of business in or from the Utility System, including any Property Taxes in respect of the Utility System, subject to this Section 3.8. The Parties acknowledge that, as of the Turnover Date, the Utility System is exempt from Property Taxes. To the extent the Utility System or any portion thereof becomes not exempt from any Property Taxes due to any cause other than acts or omissions of the Concessionaire or its Representatives, the actual costs of any resulting Property Taxes payable during the Term shall be an Uncapped O&M Cost; otherwise such costs shall be borne and paid by the Concessionaire. The Concessionaire may contest any Taxes for which it is responsible pursuant to this Section 3.8 provided that (i) no such contest may involve a reasonable possibility of forfeiture or sale of the Utility System, and (ii) upon the final determination of any

such contest, if the Concessionaire has not already done so, the Concessionaire shall pay any amount found to be due, together with any costs, penalties and interest. UMLLC shall, at no out-of-pocket cost to UMLLC, reasonably cooperate with the Concessionaire in any reasonable attempt by the Concessionaire to reduce or eliminate the Concessionaire's Tax liability. Notwithstanding anything contained herein to the contrary, it shall never be deemed an Adverse Action if the Utility System or any portion thereof becomes not exempt from any Property Taxes.

Section 3.9. Utilities.

- (a) *Charges.* Unless otherwise directed by UMLLC in writing, the Concessionaire shall ensure that contracts for utilities (other than those utilities that constitute Supplies, which is addressed in Section 7.3) provide that invoices for all charges (including all applicable Taxes and fees) for such utilities and services used in the Utility System Operations during the Term are remitted to the Concessionaire, which the Concessionaire shall pay. UMLLC does not warrant that any utility services will be free from interruptions caused by war, insurrection, civil commotion, riots, acts of God, government action, terrorism, repairs, renewals, improvements, alterations, strikes, lockouts, picketing, whether legal or illegal, accidents, inability to obtain fuel or supplies, or any other causes, and any such interruption of utility services in and of itself shall never be deemed an Adverse Action or an eviction or disturbance of the Concessionaire's use of the Utility System or any part thereof, or render UMLLC liable to the Concessionaire for damages or, unless the same constitutes a Delay Event, relieve the Concessionaire from performance of the Concessionaire's obligations under this Agreement.
- (b) *Utility Coordination.* Subject to Section 7.3, the Concessionaire shall coordinate all Utility System Operations with utilities and Persons having service lines, pipelines, transmission lines and other equipment, cables, systems and other apparatus in, on, under, over, adjacent to or otherwise interconnecting with the Utility System. The Concessionaire shall notify UMLLC in writing prior to communicating with any such utilities or Persons and shall take UMLLC's direction in connection therewith, provided such direction is in accordance with Prudent Industry Practices and applicable Law. If the Concessionaire follows the direction of UMLLC pursuant to the immediately preceding sentence, it shall be deemed to have satisfied its obligations with respect to this Section 3.9(b) solely with respect to the matter to which such direction by UMLLC relates. In connection with its obligations under this Section 3.9(b), the Concessionaire shall cause provision to be made for the removal or temporary or permanent relocation and restoration of utilities and other services and any lines, equipment, cables, systems and other apparatus not used in connection with Utility System Operations that intersect, interfere with, interface with or otherwise affect the Utility System Operations and shall arrange for temporary rights of entry and access to utilities and other services to be made available that are necessary in connection with the Utility System Operations or as may exist under this Agreement or applicable Law; *provided* that UMLLC shall cooperate with the Concessionaire with respect to the Concessionaire's obligations under this Section 3.9(b).

- (c) *No Interference.* The Parties understand and agree that nothing in Section 3.9(b) is in any way intended to interfere with the Utility System Operations by the Concessionaire, and UMLLC shall cooperate with the Concessionaire in minimizing any effect that the obligations of the Concessionaire under Section 3.9(b) and this Section 3.9(c) may have on the Utility System Operations, including reasonable efforts to schedule any such works outside of the academic term or on weekends.
- (d) *Communications Systems.* To the extent that the Concessionaire utilizes or connects with UMLLC's communications systems, the Concessionaire shall be responsible for the operation and maintenance of its telecommunications systems up until the point of connection with UMLLC's system in accordance with the Performance Standards.

Section 3.10. Notices of Defaults and Claims.

- (a) *Notice by the Concessionaire.* The Concessionaire shall promptly give notice to UMLLC (i) if the Concessionaire becomes aware that a Concessionaire Default has occurred under this Agreement (provided, however, that the failure to give such notice shall not constitute an independent Concessionaire Default) and (ii) of all material claims, proceedings, disputes (including labor disputes), or litigation in respect of the Concessionaire pertaining to the Utility System, the Utility System Operations, or UMLLC (whether or not such claim, proceeding or litigation is covered by insurance) of which the Concessionaire is aware (other than as a result of a notice to the Concessionaire from UMLLC). The Concessionaire shall provide UMLLC with all reasonable information requested by it from time to time concerning the status of such claims, proceedings or litigation.
- (b) *Notice by UMLLC.* UMLLC shall promptly give notice to the Concessionaire (i) if UMLLC becomes aware that a UMLLC Default has occurred under this Agreement (provided, however, that the failure to give such notice shall not constitute an independent UMLLC Default) and (ii) of all material claims, proceedings, disputes (including labor disputes), or litigation in respect of UMLLC pertaining to the Utility System, the Utility System Operations or the Concessionaire (whether or not such claim, proceeding or litigation is covered by insurance) of which UMLLC is aware (other than as a result of a notice to UMLLC from the Concessionaire). UMLLC shall provide the Concessionaire with all reasonable information requested by it from time to time concerning the status of such claims, proceedings or litigation.

Section 3.11. Assignment of Operating Agreements and Plans; Project Intellectual Property.

- (a) *Operating Agreements and Plans.* At the request of UMLLC, the Concessionaire shall collaterally assign, to the extent reasonably practicable and subject to the terms and conditions herein, to UMLLC, in form and substance satisfactory to UMLLC, all of the right, title and interest of the Concessionaire in, to, and under

all or any of the Operating Agreements and all present and future specifications, plans, drawings, information, and any other documentation (except Project Intellectual Property) in relation to the Utility System Operations regardless as to whether any of the foregoing involve proprietary information (collectively, the “Operating Agreements and Plans”) as collateral security to UMLLC for the observance and performance by the Concessionaire of its covenants and obligations under this Agreement. The Concessionaire covenants that it shall cause all of the right, title, and interest of the Concessionaire in, to, and under all Operating Agreements and Plans entered into or created after the Time of Turnover to be collaterally assignable and transferable to UMLLC as provided in this Section 3.11(a). UMLLC acknowledges and agrees that the Operating Agreements and Plans may also be assigned as security to a Leasehold Mortgagee and that each of UMLLC and such Leasehold Mortgagee shall be entitled to use the Operating Agreements and Plans in enforcing their respective security interests as hereinafter provided. Without limiting the generality of the foregoing, UMLLC shall be entitled to use the Operating Agreements and Plans in the event of, and as necessary to, remedy a Concessionaire Default under this Agreement for so long as such Concessionaire Default is continuing and has not been cured. Notwithstanding the foregoing, in the event that any such Leasehold Mortgagee has entered into possession or is diligently enforcing and continues to diligently enforce its security, whether by way of appointment of a receiver or manager, foreclosure or power of sale in accordance with Article 19 or otherwise, or has entered (or is in process to enter) into a New Agreement under Section 19.5 and is using the Operating Agreements and Plans in respect of the Utility System Operations, UMLLC shall not be entitled to use the Operating Agreements and Plans in enforcing its security, it being acknowledged that any assignment of the Operating Agreements and Plans to a Leasehold Mortgagee shall have priority at all times (other than if UMLLC is enforcing its rights to cure under Section 3.3(c)(i)(B) or, if the Leasehold Mortgagee’s extended cure period under Section 19.3, if any, has expired and the Leasehold Mortgagee has not commenced any action to effect a cure in accordance therewith, Section 16.1(b)(iii)) over any assignment of the Operating Agreements and Plans to UMLLC. The Concessionaire shall promptly deliver to UMLLC, at the sole cost and expense of the Concessionaire, forthwith after completion or execution and delivery, a copy of each item of the Operating Agreements and Plans. UMLLC agrees that (i) it shall bear all risks associated with the use of the Operating Agreements and Plans, (ii) it may not rely on the Operating Agreements and Plans, and (iii) under no circumstances will the Concessionaire be liable in any way with respect to UMLLC’s use of, or for any loss or damage of any kind incurred as a result of the use of, the Operating Agreements and Plans.

- (b) *Project Intellectual Property.* Each of UMLLC and the University shall have and is hereby granted a nonexclusive, transferable, irrevocable, perpetual, fully paid up right and license to use, exploit, reproduce, modify, adapt, and disclose, and sublicense others to use, reproduce, modify, adapt, and disclose, the intellectual property (including business systems and patents) of the Concessionaire, the IMP Contractor, or the Operator solely used in connection with the Utility System (the “Project Intellectual Property”), subject to the following:

- (i) Each of UMLLC and the University shall have the right to exercise such license only in connection with the Utility System and Utility System Operations;
- (ii) Each of UMLLC and the University shall have the right to exercise such license only at the following times: (A) from and after the expiration or earlier termination of the Term for any reason whatsoever; (B) during any time that UMLLC is exercising its rights pursuant to Section 3.7(a)(ii) or Section 3.7(a)(iii); and (C) during any time that a receiver is appointed for the Concessionaire, or during any time that there is pending a voluntary or involuntary proceeding in bankruptcy in which the Concessionaire is the debtor;
- (iii) Neither UMLLC nor the University shall at any time use, reproduce, modify, adapt and disclose, or allow any party to use, reproduce, modify, adapt and disclose, any such Project Intellectual Property for any other purpose;
- (iv) the right to transfer the license is limited to any Person that succeeds to the power and authority of UMLLC or the University generally or with respect to the Utility System, and all such transfers shall be subject to Section 3.11(b)(v);
- (v) the right to sublicense is limited to concessionaires, contractors, subcontractors, employees, attorneys, consultants, and agents that are retained by or on behalf of UMLLC and the University in connection with the Utility System, and all such sublicenses shall be subject to Section 3.11(b)(v); and
- (vi) except to the extent required by Law, UMLLC will ensure that it and the University (A) shall not disclose any Project Intellectual Property to any Person other than authorized transferees and sublicensees who agree to be bound by any confidentiality obligations of UMLLC relating thereto; (B) shall enter into a commercially reasonable confidentiality agreement if requested by the Concessionaire with respect to the licensed Project Intellectual Property; and (C) include, or where applicable require the contract with the transferee or sublicensee to include, a covenant to employ sound business practices no less diligent than those used for its own confidential information, and no less diligent than required by commercially reasonable standards of confidentiality, to protect all Project Intellectual Property of the Concessionaire and other materials provided under the license or sublicense, as the case may be, against disclosure to third parties not in receipt of a license or sublicense, as applicable, and to use the license or sublicense only for the permitted purposes;

provided that: (A) for the avoidance of doubt, the Concessionaire shall continue to have a full and complete right to use any and all duplicates or other originals of its

Project Intellectual Property in any manner it chooses, and (B) UMLLC agrees that if it uses any Project Intellectual Property (x) it shall bear all risks associated with the use of the Project Intellectual Property, (y) it may not rely on the Project Intellectual Property, and (z) under no circumstances will the Concessionaire be liable in any way with respect to UMLLC's use of, or for any loss or damage of any kind incurred as a result of the use of, the Project Intellectual Property.

Section 3.12. Use of Information and Records.

- (a) Unless prohibited by applicable Law and to the extent reasonably necessary, UMLLC shall be entitled to access all reasonable records, electronic data, and other information collected and retained by the Concessionaire with respect to the Utility System and the Utility System Operations, including utility usage data, consumption pattern information, and other utility data, and the Concessionaire shall maintain such records, data, and other information in a format that is readily accessible to UMLLC in order to facilitate UMLLC's efforts with respect to energy efficiency, sustainability, environmental impact and research. UMLLC shall use commercially reasonable efforts to provide at least two (2) Business Days' written notice prior to accessing such records. At least thirty (30) Days prior to the Turnover Date, the Concessionaire shall deliver to UMLLC for its Approval a proposed policy for the maintenance and retention of all records related to the operation and maintenance of the Utility System (once Approved, the "Record Retention Policy"). If UMLLC does not Approve the Record Retention Policy, it shall provide the Concessionaire a reasonably detailed explanation for its disapproval, and the Concessionaire shall, promptly thereafter, submit a revised Record Retention Policy intended to address UMLLC's comments, and this process shall continue until UMLLC Approves a Record Retention Policy. Following the Approval of the Record Retention Policy, the Concessionaire shall maintain all records related to the operation and maintenance of the Utility System in accordance with such Record Retention Policy. UMLLC covenants and agrees that it will implement safeguards to protect against the disclosure or misuse of any such Concessionaire information that is in its care or custody and will promptly inform the Concessionaire if there is any breach or suspected breach of security related to such information, subject to Section 8.2(b).
- (b) Unless prohibited by applicable Law, the Concessionaire shall be entitled to access all reasonable records, electronic data, and other information collected and retained by UMLLC to the extent reasonably required for, and only for the purpose of, the Concessionaire's performance of its obligations under this Agreement and the Performance Standards, including the maintenance of any Authorization. UMLLC shall promptly make such records, data, and information available to the Concessionaire as reasonably requested by the Concessionaire. Unless disclosure is required by applicable Law, the Concessionaire shall keep confidential any information obtained from UMLLC or its Representatives, including any information obtained through its performance of the Utility System Operations. The Concessionaire covenants and agrees that it will implement safeguards to protect against the disclosure or misuse of any such UMLLC information that is in

its care or custody and will promptly inform UMLLC if there is any breach or suspected breach of security related to such information. If any information obtained from UMLLC or its Representatives is provided by the Concessionaire, or UMLLC on behalf of the Concessionaire, to any third party, including any equity member of the Concessionaire, the Operator or any Contractor, then (i) the Concessionaire shall cause such third party to comply with the provisions of this Section 3.12(b) and (ii) the Concessionaire shall be liable for the disclosure or use of such information by such third party as if the Concessionaire had disclosed or used it.

Section 3.13. Standard of Operation and Maintenance of the Utility System; Warranty Period Utility System Projects. At all times during the Term, the Concessionaire shall be required to maintain and operate the Utility System in accordance with the Performance Standards and Prudent Industry Practices. In the event any maintenance, repair, or replacement is required in respect of any Warranty Period Utility System Project, other than in connection with an Emergency (in which case, only to the extent of such Emergency), the Concessionaire shall consult with UMLLC prior to undertaking any such maintenance or repair. If such maintenance, repair, or replacement could be covered by the warranty provided by the contractor that completed such Warranty Period Utility System Project, as determined by UMLLC acting in good faith, then UMLLC shall make a warranty claim to the contractor providing such warranty and shall use commercially reasonable efforts to pursue such claim and cause the contractor providing such warranty to perform such maintenance, repair or replacement pursuant to such warranty, provided that if UMLLC is unsuccessful in causing such contractor to do so, then the Concessionaire shall perform such maintenance, repair, or replacement. The foregoing obligation shall expire for each Warranty Period Utility System Project contemporaneously with the expiration of the applicable warranty period from such contractor, and UMLLC shall provide notice to the Concessionaire of such expiration. Any Excluded Utility System Projects that remain under warranty following their completion by UMLLC and delivery to the Concessionaire shall be treated as Warranty Period Utility System Projects until the expiration of the applicable warranty period for such Excluded Utility System Project.

Section 3.14. Payments by UMLLC. The Concessionaire acknowledges and agrees that if UMLLC is required under applicable Law of general application to withhold a portion of any payment that UMLLC is obligated to make to the Concessionaire under this Agreement and to pay such amount to a Governmental Authority, UMLLC will be deemed to have satisfied such payment obligation to the Concessionaire to the extent of such withholding by UMLLC and payment to the appropriate Governmental Authority. If any such withheld amounts are permitted to be paid to the Concessionaire, UMLLC shall pay such amounts to the Concessionaire whenever permitted by Law. Any items and payment amounts that, to the Actual Knowledge of UMLLC ten (10) Business Days prior to the Turnover Date, it is legally required to withhold from the Concessionaire as of the Turnover Date will be listed in Schedule 14 and agreed to by the Concessionaire, acting reasonably, prior to Turnover as a condition of Turnover, provided that regardless of whether any payment is listed on Schedule 14, UMLLC shall always have the right to withhold payments pursuant to this Section 3.14 if required by Law and shall not be in breach of this Agreement. Prior to withholding any portion of any payment hereunder, UMLLC shall give reasonable prior notice to the Concessionaire of the proposed withholding, and the Concessionaire shall promptly notify UMLLC of any challenge by the Concessionaire to such proposed withholding. For the avoidance

of doubt, any payment obligation of a UMLLC's department, office or center required by this Agreement is a payment obligation of UMLLC for purposes of this Agreement, and UMLLC shall either cause such department, officer or center to pay the payment obligation or shall satisfy the payment obligation itself.

Section 3.15. Naming and Signage Rights, Other Revenue Activities and Commercial Advertisements and Activities.

- (a) Due to the importance of having uniform signage on the University Campus for safety and aesthetic purposes, the Concessionaire shall have no right to name or modify the name of the Utility System or any portion thereof or, unless required to do so by applicable Law, to install signage of any kind thereon, without UMLLC's Approval, which may be withheld in its discretion.
- (b) UMLLC shall have the right, in its discretion, to install, replace, display, and maintain signage (i) that relates to identification or naming of the Utility System, the Utility Facilities, portions thereof, or surrounding areas or (ii) for informational or educational purposes; *provided* that (A) the Concessionaire shall have no obligation under the Performance Standards to replace or maintain any signage installed by UMLLC for advertising purposes, and (B) UMLLC shall not install any signage that relates to naming of the Utility System, the Utility Facilities, portions thereof, or surrounding areas for a Person that competes directly with the Concessionaire or the Operator.
- (c) The Concessionaire shall not, without UMLLC's Approval, provide utility services to customers other than the University or UMLLC or make market-based sales of electricity. To the extent UMLLC Approves any such activities, the Concessionaire shall be liable to UMLLC for, and reimburse UMLLC for, any Losses incurred by UMLLC as a result thereof, including any increase or additional Property Taxes imposed upon UMLLC or the Utility System, the cost of which may not be included in any component of the Utility Fee, provided that UMLLC's Approval shall not be required to explore and investigate such additional sources of revenue so long as the Concessionaire does not implement such additional sources of revenue and the Concessionaire is liable for any Losses to UMLLC as a result of such exploration and investigation. To the extent possible, the Concessionaire shall pay any increased or additional Property Taxes resulting from such additional sources of revenue directly to the applicable Governmental Authority.
- (d) Notwithstanding anything to the contrary contained herein, due to the importance of having uniform nutritional choices on the University Campus, UMLLC hereby reserves the right to install and operate vending machines in any portion of the Utility System and to access the Utility System for the purposes thereof, and UMLLC shall be entitled to the revenue generated by such vending machines.
- (e) UMLLC and the Concessionaire agree that they shall execute on Turnover a trademark license agreement in the form attached hereto as Schedule 20.

Section 3.16. Reversion of Utility System. On the Reversion Date, the Concessionaire shall surrender and deliver to UMLLC all of its rights, title, and interest in the Utility System (including all improvements to the Utility System, the Utility System Assets and all tangible and intangible personal property of the Concessionaire (including inventories) that is included in the Utility System and used in connection with the Utility System Operations) subject, however, as to any intellectual property included in the Utility System, to any restrictions or prohibitions to disclosure, transfer, or sharing thereof and any other rights of third parties with respect thereto, all in accordance with the provisions of Section 16.3. With respect to any third party or proprietary software utilized by the Concessionaire in the operation of the metered Utility System at the time of the Reversion Date, the Concessionaire and UMLLC will negotiate in good faith appropriate license rights and terms for UMLLC's continued use of the software following reversion.

Section 3.17. Police, Fire, Emergency and Public Safety Access Rights. Notwithstanding any other provision of this Agreement, at all times during the Term and without notice or compensation to the Concessionaire: (i) any police, fire, and emergency services and any other security or emergency personnel retained by or on behalf of UMLLC shall have access, as required by such services or personnel, to the Utility System; (ii) UMLLC shall have access to the Utility System as necessary for the protection of public safety; and (iii) any Governmental Authority with jurisdiction over the Utility System shall have access to the Utility System as necessary for inspection, emergency management, and homeland security purposes, including the prevention of or response to a public safety emergency (so long as any exercise of such jurisdiction, to the extent effected by UMLLC, shall be strictly in accordance with the terms hereof).

Section 3.18. Negotiations with Third Parties. Prior to entering into any agreement with any third party, including any Governmental Authority, in connection with the Utility System Operations (a "Third Party Agreement") that extends or could extend beyond the Term or pursuant to which UMLLC may incur any liability whatsoever thereunder, the Concessionaire shall submit such Third Party Agreement for Approval by UMLLC (which Approval may be withheld, conditioned, or delayed in the discretion of UMLLC) prior to the execution and delivery thereof (except with respect to Third Party Agreements the absence of which may cause the Concessionaire or Utility System Operations to fail to be in compliance with applicable Law or this Agreement, in which case the Concessionaire may enter into such Third Party Agreement upon notice to UMLLC provided that the Concessionaire indemnifies UMLLC for any Losses relating thereto).

Section 3.19. Administration of the Public Way. The Concessionaire acknowledges and accepts that UMLLC holds and administers the Public Way for the non-discriminatory benefit of all Persons and interests, including the Concessionaire and the Concessionaire Interest. The rights granted to the Concessionaire under this Agreement do not create a priority in favor of the Concessionaire over any other user of the Public Way, and such rights are subject to the Performance Standards and all provisions of Law.

Section 3.20. Rights to Adjacent Space. Subject to the approval of the University, UMLLC hereby reserves, and is not demising or leasing to the Concessionaire, the right or easement to construct and reconstruct and forever maintain the air rights with respect to the Utility Facilities and other property within the Utility System and the right to construct, use or occupy any of the space not directly occupied by the Utility System, including (i) any and all space located

above, below or adjacent to any such property, and (ii) any and all space located above, below or adjacent to any improvements within the Utility System as of the date hereof, provided that such construction, use or occupancy does not materially impair the Utility System Operations. For the avoidance of doubt, to the extent that any Utility Facility is buried below the surface of any part of the University Campus, UMLLC shall have the right to construct any building, structure or other improvement on that part of the University Campus, provided such construction does not damage or alter such buried Utility Facilities. UMLLC's exercise of its rights hereunder shall not be subject to any of the terms and conditions of Section 3.7(a).

Section 3.21. Sole Utility Provider. UMLLC covenants that, during the Term, it will not, and it will not contract or agree with any third party to, provide any Utility or Utility Services on the University Campus, except with respect to the following circumstances or activities: (a) as of the Turnover Date, a third party is providing the relevant Utility or Utility Services to a portion of the University Campus, in which case UMLLC may continue to have that third party or a successor thereto or a replacement thereof provide such Utility or Utility Services during the Term on only that portion of the University Campus; (b) as of the Turnover Date, any district utility systems within the University Campus which are generating or distributing Utilities beyond the lines of demarcation identified in the Performance Standards; (c) UMLLC installs systems, equipment or materials for the distribution of Utilities beyond the lines of demarcation identified in the Performance Standards, which shall be performed by or on behalf of UMLLC; (d) the performance of any Capital Improvements described in Section 4.1(b); or (e) the performance of any work on the Building Mechanical Systems.

Section 3.22. Adjustments to the Location or Configuration of the Utility System. UMLLC shall have the right, upon notice to the Concessionaire, to cause the Concessionaire to alter the location or configuration of the Utility System or to designate alternative real property for the Utility System Land to the extent UMLLC deems it necessary or useful in the operation and use of the University Campus, including in connection with the reconstruction of a Utility Facility following a fire or other casualty. Except as provided in Section 13.4 with respect to any modifications in connection with a casualty, to the extent such alteration or designation of alternative real property is a Capital Improvement, it shall be considered a New Approved Capital Improvement for a budgeted cost and an increase in the Capped O&M Amount reasonably approved by the Concessionaire and UMLLC, but, to the extent such alteration or designation of alternative real property is not a Capital Improvement, the costs incurred by the Concessionaire or the Operator as a result of UMLLC's exercise of its right under this Section 3.22 shall be considered an Uncapped O&M Cost in accordance with the definition thereof. If UMLLC directs the Concessionaire to relocate the Utility System to a location to which it does not have a right to access pursuant to this Agreement, UMLLC shall grant occupancy rights to the Concessionaire sufficient for the Concessionaire to meet its obligations hereunder. If UMLLC designates alternative real property for the Utility System Land, then, upon such designation, (i) such alternative real property shall be deemed Utility System Land for purposes of this Agreement, (ii) the Concessionaire shall return the prior Utility System Land and all improvements and Utility Facilities thereon to UMLLC in the condition required under Section 16.3, at no additional cost to UMLLC, other than out-of-pocket costs incurred by the Concessionaire in connection with such transfer (including the cost of recording the conveyance documentation and the cost of a title policy for the alternative real property for the Utility System Land in the event that the Concessionaire received a title policy with respect to the original Utility System Land), and (iii) in accordance

with UMLLC's designation of alternative real property, the Concessionaire shall relocate the Utility Facilities then existing on the prior Utility System Land to the alternative real property. The Concessionaire shall have the right to amend the Memorandum of Sub-Lease to reflect any changes resulting from UMLLC's exercise of its right under this Section 3.22, and UMLLC shall reasonably cooperate in such amendment and shall pay the out-of-pocket costs incurred by the Concessionaire in connection therewith. In connection with alteration as set forth in this Section 3.22, the Concessionaire and UMLLC shall adjust the Key Performance Indicators in light of such alteration.

Section 3.23. Sales to Individual Customers on the University Campus. The Concessionaire shall not be permitted to sell any fuels or Supplies to individual customers on the University Campus. To the extent that the Concessionaire supplies fuels or Supplies to UMLLC for distribution to individual customers, UMLLC shall control the distribution of such fuels or Supplies. The Concessionaire shall have no interests or rights to charge or collect any payments from UMLLC or such individual customers for the provision of such fuels or Supplies.

Section 3.24. University Master Plan. The Concessionaire shall reasonably cooperate with the University and UMLLC in connection with the University's master plan (including in connection with the development of the Master Plan to the extent relevant to the Utility System) and shall attend any University and/or UMLLC meetings regarding such plan if requested by the University or UMLLC.

Section 3.25. Utility System Tours. The Concessionaire shall provide tours of the Utility System or any portion thereof to UMLLC and its Representatives upon reasonable request by UMLLC, provided that (i) the Concessionaire shall have the right to refuse to give any tour if such tour would unreasonably interfere with the operation of the Utility System or any of the Concessionaire's other obligations hereunder and (ii) all tour participants shall be required to comply with the Concessionaire's reasonable safety protocols and requirements to the extent provided in writing to UMLLC.

Section 3.26. Uniforms. To aid the University's provision of security and safety measures to the University Campus, the Concessionaire and Operator personnel working on the University Campus shall wear a uniform (and other insignia) that is standard across the Utility System and clearly identifies such personnel as the Concessionaire and Operator personnel and not employees of the University.

Section 3.27. Sustainability. The Concessionaire acknowledges that UMLLC and the University have a long-term commitment to operating the University Campus in a sustainable manner and that the Utility System Operations are an integral part of that commitment. As such, consistent with Prudent Industry Practices and subject to obtaining any required UMLLC Approvals for Capital Improvements and Material Changes, the Concessionaire agrees that, in connection with the Utility System Operations, it will reasonably cooperate with UMLLC to operate the Utility System in a manner consistent with the University's larger goal to promote a sustainable campus and to acknowledge stewardship of the natural environment and resources by UMLLC and its stakeholders. The Concessionaire will use commercially reasonable efforts to implement any changes to the Utility System Operations requested by UMLLC in the form of a UMLLC Directive to increase the sustainability of the Utility System Operations that do not

materially and adversely affect the Concessionaire's ability to meet its obligations hereunder, including the obligation to meet the Performance Standards. In addition, the Concessionaire will use commercially reasonable efforts throughout the Term to propose Capital Improvements and Material Changes pursuant to Article 4 that are reasonably intended to increase the sustainability of the Utility System Operations and the University Campus, including reduction of emissions, Utility use, and other impacts on the environment. Further, the Concessionaire shall attend any UMLLC meetings regarding sustainability planning on the University Campus if requested by UMLLC. Further, the Parties acknowledge that what constitutes "sustainability" may evolve over the Term and that the Parties intend that, for purposes of this Section 3.27, "sustainable" and "sustainability" shall have the then-current generally accepted utility industry meaning of the term, which, as of the date of this Agreement, includes undertaking measures to (i) reduce energy and water consumption, (ii) become a net-negative energy use, (iii) reduce the impact of operations on the environment, (iv) recycle and reuse resources, (v) purchase goods and services derived in a sustainable manner, and (vi) employ goods and services that protect the environment. For the avoidance of doubt, the Concessionaire shall not be required to incur costs that would otherwise be Uncapped O&M Costs to comply with this Section 3.27 unless such costs are included in an Approved Five-Year Plan.

Section 3.28. Student Educational Experiences. During the Term and at the request of UMLLC, the Concessionaire shall discuss, or shall cause the Operator to discuss, with UMLLC in good faith the development and maintenance of the following programs of the Concessionaire or the Operator, as the case may be: (i) a program for the employment of students of the University in connection with the Utility System Operations; (ii) an internship program for University students to gain hands-on, practical experience with structured educational and mentorship opportunities either with respect to the Utility System or other utility systems owned, leased, operated, or maintained by the Concessionaire, the Operator, or any of their Affiliates; (iii) a program for employment of apprentices serving industrial and skilled trades of boiler makers in connection with the Utility System Operations; and (iv) structured educational and mentorship opportunities either with respect to the Utility System or other utility systems owned, lease, operated, or maintained by the Concessionaire, the Operator or any of their Affiliates; in each case which shall be on such reasonable terms and conditions as determined by the Concessionaire or the Operator, as applicable.

Section 3.29. Office Space. To the extent requested by the Concessionaire in writing, the Parties shall use reasonable efforts to enter into a commercially reasonable license agreement with respect to the temporary license of office space (not to exceed [●] square feet) by UMLLC to the Concessionaire within a location on the University Campus at no additional cost. UMLLC shall not be required to provide such space if it determines, in its sole discretion, that it does not wish to provide such space based on its current use, and it may terminate such license or may cause such licensed space to be moved to a new location at any time upon Notice to the Concessionaire and may require the Concessionaire to abide by reasonable rules and regulations, including limiting the hours of access thereto.

Section 3.30. Utility System Space in Larger Buildings. The Concessionaire acknowledges that each of [●] (the "Shared Spaces") are not separate buildings but are spaces within larger buildings that the University owns. As such, UMLLC shall retain the responsibility, either by UMLLC employees or Contractors at UMLLC's direction, to maintain, repair, replace,

and keep in good order and condition the structural and building-system components of the buildings in which the Shared Spaces are located, including the roof, load-bearing walls, and foundations of each of the foregoing, except to the extent any maintenance, repair or replacement is caused by the negligence or willful misconduct of, or violation of applicable Law by, the Concessionaire or its Representatives, in which case the Concessionaire shall be responsible therefor and shall perform such maintenance, repair or replacement as promptly as reasonably practicable. Subject to UMLLC's rights under Section 3.22, if a building in which a Shared Space is located is damaged by a fire or other casualty of any kind or nature, then UMLLC shall restore such building to the condition in which it existed prior to such fire or other casualty but shall not, for the avoidance of doubt, be responsible for repairing or restoring the furniture, fixtures or equipment within the Shared Space that are part of the Utility System. The Concessionaire shall abide by any reasonable rules and regulations promulgated by UMLLC and provided to the Concessionaire in writing with respect to the buildings in which the Shared Spaces are located, and the Concessionaire shall have non-exclusive access to any common areas of the larger buildings (as identified by UMLLC) in which those Shared Spaces are a part. The Concessionaire shall not be obligated to pay any additional rent with respect to the Shared Spaces.

ARTICLE 4 CAPITAL IMPROVEMENTS AND MATERIAL CHANGES

Section 4.1. Concessionaire Responsibility for Capital Improvements.

- (a) Other than the Excluded Utility System Projects, the Concessionaire shall be responsible for all Capital Improvements with respect to the Utility System required to be completed by it during the Term in accordance with the terms of this Agreement, including as required by the Performance Standards. For the avoidance of doubt, improvements or upgrades to the Building Mechanical Systems shall not be considered Capital Improvements with respect to the Utility System pursuant to this Agreement.
- (b) Notwithstanding anything in this Agreement to the contrary, UMLLC and the University reserve the right to procure Capital Improvements to the Utility System from any Person other than the Concessionaire pursuant to a competitive bid or other public procurement if and to the extent that such Capital Improvements are approved by the State through the University's capital outlay plan, and such State approval of such Capital Improvements and the funds budgeted therefor are contingent on a competitive bid or other public procurement process therefor; *provided* that, in such a circumstance, to the extent allowed by Law and subject to any conditions imposed by the State on the use of the relevant capital outlay funds, (i) the Concessionaire shall be allowed to participate in the procurement and delivery process (including drafting performance specifications and oversight of project delivery) for such Capital Improvements to ensure that Key Performance Indicators and Performance Standards are not impacted by the project's design and delivery, and (ii) to the extent reasonably practicable, as part of such competitive bid or other public procurement process, the Parties shall endeavor to procure Utility-related equipment of such brands, models or types that will ensure system compatibility and maximize future repair and maintenance efficiencies (provided

that there shall be no exclusivity with respect to the procurement of Utility-related equipment). In the event that (i) UMLLC or the University procures a Capital Improvement from any Person other than the Concessionaire pursuant to a competitive bid or other public procurement process, as provided in this Section 4.1(b), (ii) such Capital Improvement is funded by moneys sourced from a capital outlay from the State in an amount equal to or greater than fifty percent (50%) of the total capital cost of such Capital Improvement, (iii) the total capital cost of such Capital Improvement exceeds one million dollars (\$1,000,000) in the aggregate, and (iv) UMLLC designates the Concessionaire (or its Affiliate) the representative of UMLLC or the University, as the case may be, with respect to such Capital Improvement on terms acceptable to the Concessionaire (acting reasonably), then UMLLC shall pay the Concessionaire a development fee equal to two and one-half percent (2.5%) of the total capital costs of such Capital Improvement that were funded by such capital outlay from the State upon the substantial completion thereof.

Section 4.2. Authorizations Related to Capital Improvements. The Concessionaire's obligation to perform Capital Improvements shall be subject to the issuance by Governmental Authorities and UMLLC of any and all Authorizations required to be issued by such parties with respect thereto, and UMLLC agrees (i) not to unreasonably withhold, condition or delay the issuance of any Authorization to be issued by UMLLC for an Approved Capital Improvement and (ii) to use its reasonable efforts to assist the Concessionaire in obtaining any Authorizations required to be issued by Governmental Authorities, provided that the Concessionaire shall reimburse UMLLC in a timely manner for any reasonable out-of-pocket costs incurred by UMLLC in providing such assistance. Without limiting the generality of the foregoing, UMLLC agrees that it will reasonably assist and cooperate with the Concessionaire in obtaining any and all Authorizations (including any required rights of access over real property that is owned or controlled by UMLLC) in order for the Concessionaire to perform an Approved Capital Improvement, which assistance shall include providing the Concessionaire reasonable access to the areas of the University Campus where the Approved Capital Improvement will be located, subject to the reasonable conditions and restrictions of UMLLC, provided that the Concessionaire shall reimburse UMLLC in a timely manner for any reasonable out-of-pocket costs incurred by UMLLC in providing such assistance.

Section 4.3. Approval of Capital Improvements and Material Changes.

- (a) The Concessionaire shall not have the right to make any (i) Capital Improvements or (ii) Material Changes, except those Capital Improvements or Material Changes which either (A) constitute the Initial Modernization Project or (B) are otherwise Approved pursuant to Section 4.3(c). For the avoidance of doubt, the Approval of Final Design and the performance and delivery of the Initial Modernization Project shall be governed by the specific provisions of this Agreement relating to the Initial Modernization Project (including Section 2.4(f), Article 21, and Article 22). In addition, subject to the proviso of this Section 4.3(a), TEP shall be: (x) the Contractor responsible for the design, construction, and completion of any Capital Improvements or Material Changes which are Approved pursuant to Section 4.3(c); and, in such capacity, (y) under the direction, supervision and control (by

ownership, contract or otherwise) of the Concessionaire, and no delegation by the Concessionaire to TEP with respect to such Capital Improvement or Material Change shall relieve the Concessionaire of any obligations, duties or liability hereunder; [provided that the Concessionaire shall have the right to appoint a Contractor other than TEP for the purposes of designing, constructing, and completing any Capital Improvements or Material Changes which are Approved pursuant to Section 4.3(c), as jointly determined by the University, UMLLC and CenTrio, taking into consideration, among other relevant factors, TEP's prior performance and TEP's proposed costs or other terms.]¹

- (b) The Concessionaire shall have the right to request Approval of (I) a proposed Capital Improvement or Material Change or (II) a change in the scope or cost of a previously Approved Capital Improvement or Material Change at any time (and shall identify whether an item requested for Approval or any portion thereof is a Capital Improvement or Material Change or a combination thereof), but UMLLC shall not be obligated to consider any such requests for Approval except those requests (i) (A) contained in a proposed Five-Year Plan submitted in accordance with Section 7.2 and (B) proposed to be commenced in the first (1st) full Fiscal Year in such proposed Five-Year Plan; (ii) required to address an Emergency, a change in Law or a change in a Performance Standard; (iii) required in connection with a UMLLC Directive; or (iv) required due to Force Majeure, all of which UMLLC shall consider in good faith.
- (c) The Concessionaire shall request Approval of one or more proposed Capital Improvements or Material Changes or Approval of a proposed change in the scope or cost of a previously Approved Capital Improvement or Material Change by (1) submitting a request to UMLLC, or an office or person designated by UMLLC Liaison, containing a detailed description of each proposed Capital Improvement or Material Change or proposed change in the scope or cost of a previously Approved Capital Improvement or Material Change or (2) submitting a proposed Five-Year Plan in accordance with Section 7.2 containing a detailed description of each proposed Capital Improvement or Material Change proposed to be commenced in the first (1st) full Fiscal Year in such proposed Five-Year Plan or each proposed change in the scope or cost of a previously Approved Capital Improvement or Material Change, provided that, in each case, such detailed description shall include: (A) total costs for construction and installation thereof, including all hard and soft costs, any financing costs and any applicable sales or use tax, which shall be presented on an Open Book Basis; (B) forecasted annual operations and maintenance costs therefor; (C) any proposed modification to the Recovery Period (if applicable) for such Capital Improvement; (D) an explanation of all relevant assumptions, variables, and data sources, used to develop the proposal; (E) the proposed schedules, process, and other technical and logistics details associated with the proposed Capital Improvement and/or Material Change proposal, including any liquidated damages if the Concessionaire fails to meet the proposed schedule; (F) how such proposed Capital Improvement and/or Material

¹ **Note to CenTrio:** LSU will conform the bracketed language to the CEA once finalized.

Change will improve the sustainability of the Utility System Operations or the University Campus; (G) any actual or anticipated tax credits or other benefits that will accrue to the Concessionaire as a result thereof of which the Concessionaire has knowledge, and a description thereof as well as a description as to how such credits or benefits will be incorporated into the Capital Improvement Cost (if Approved); (H) any fee or charge payable to the Contractor in connection with such Capital Improvement or Material Change; (I) any proposed change to the limits on the professional liability insurance coverage for the professionals providing services with respect to such Capital Improvement or Material Change and the associated change in the premium associated therewith; (J) any potential increase or reduction in Supply Costs or consumption of Supplies that would result from such Capital Improvement or Material Change; and (K) the terms of any payment and/or performance security required by Law or otherwise required hereunder in order to undertake such Capital Improvement or Material Change; *provided* that, (x) to the extent any of the details set out in clauses (A) through (K) above are unavailable or inapplicable, the Concessionaire shall describe the reason for such unavailability or inapplicability and (y) to the extent that the Concessionaire has explicitly requested that UMLLC respond only pursuant to Sections 4.3(c)(ii), (iii), or (iv), the Concessionaire may include an indicative estimate or estimate range with respect to Sections 4.3(c)(A) or (B). To the extent UMLLC elects to, or is required to, consider a request for Approval of a proposed Capital Improvement or Material Change or a change in the scope or cost of a previously Approved Capital Improvement or Material Change, UMLLC shall review such request and, in its discretion:

- (i) Approve such request in accordance with the terms of such request after having undertaken all such necessary action and secured all authorizations, consents and approvals required to be obtained by UMLLC with respect to such Approval at such time, unless the Concessionaire's written request submitted to UMLLC explicitly requested that UMLLC respond only pursuant to Sections 4.3(c)(ii), (iii), or (iv); or
- (ii) provide a written response requiring that the Concessionaire (1) perform additional work with respect to such proposed Capital Improvement or Material Change or proposed change in the scope or cost of a previously Approved Capital Improvement or Material Change to provide further information regarding the scope, design or cost thereof and/or multiple alternative designs therefor to UMLLC, which additional work may include procuring design services or a quotation for a guaranteed maximum price or lump sum contract from a contractor or multiple contractors for the proposed Capital Improvement or Material Change or proposed change in the scope or cost of a previously Approved Capital Improvement or Material Change or procuring any details set out in clauses (A) through (K) of Section 4.3(c)(2) that were previously unavailable, provided that the cost of such additional work shall be subject to UMLLC's prior Approval, and (2) after performing such additional work, submit a revised request for Approval by UMLLC pursuant to this Section 4.3(c), which revised request,

if the initial request was made in connection with the submission of a proposed Five-Year Plan, UMLLC shall consider with respect to the same proposed Five-Year Plan, if submitted within fifteen (15) Days before the commencement of the first (1st) Fiscal Year of such Five-Year Plan; or

- (iii) (1) provide the Concessionaire with comments on such proposed Capital Improvement or Material Change or proposed change in the scope or cost of a previously Approved Capital Improvement or Material Change, including comments on any details provided in the Concessionaire's proposal, which may include comments from UMLLC intended to align the proposal with the larger University Campus capital improvement plans existing at such time or disagreeing with its characterization as a Capital Improvement or Material Change, and (2) require that the Concessionaire incorporate such comments and submit a revised request for Approval pursuant to this Section 4.3(c); *provided* that if UMLLC elects to exercise its rights under this Section 4.3(c)(iii), then the Concessionaire shall have the right, upon written notice to UMLLC, to withdraw its request for Approval; or
- (iv) (1) reject such proposed Capital Improvement or Material Change or proposed change in the scope or cost of a previously Approved Capital Improvement or Material Change and (2) if such proposed Capital Improvement or Material Change or change to the scope of a previously Approved Capital Improvement or Material Change is necessary to comply with Prudent Industry Practices, applicable Law, or the Performance Standards, provide the Concessionaire with a reasonably detailed explanation for such rejection, provided that UMLLC shall not be permitted to reject such proposal under this Section 4.3(c)(iv) if (w) such proposal is required to cause the Utility System to comply with any new Law or change in Law existing as of the Turnover Date and the Concessionaire has received written notice from the applicable Governmental Authority that the Utility System is not in compliance therewith, (x) the Concessionaire has reasonably investigated any potential alternatives to such proposal and provided UMLLC with reasonable evidence of such investigation, (y) the Concessionaire has discussed in good faith with UMLLC and reasonably considered any potential viable alternatives to such proposal and (z) UMLLC has provided no reasonable alternative that would address such new or changed Law, as applicable, that UMLLC has confirmed that it would Approve.

Notwithstanding anything to the contrary in the foregoing, if a single request for Approval pursuant to this Section 4.3(c) includes multiple discrete proposed Capital Improvements or Material Changes or changes in the scope or cost of a previously Approved Capital Improvement or Material Change, UMLLC shall have the right to provide different responses with respect to each proposal included in such request.

- (d) To the extent that the Concessionaire elects to abandon a proposed Capital Improvement or Material Change after it has been Approved by UMLLC, which the Concessionaire may do so upon Notice to UMLLC, unless such Capital Improvement or Material Change is the subject of a UMLLC Directive, the Concessionaire shall be obligated to promptly restore the Utility System and any other affected area of the University Campus to the condition that existed prior to the commencement of such Capital Improvement or Material Change. As a condition of its Approval of any proposed Capital Improvement or Material Change or proposed change in the scope or cost of a previously Approved Capital Improvement or Material Change, UMLLC may require certain payments of liquidated damages by the Concessionaire to UMLLC if the Concessionaire does not meet the timeframe set forth in the applicable Approval regardless of the abandonment of such Capital Improvement or Material Change, but only to the extent such liquidated damages are proposed in the Concessionaire's most recent request for Approval thereof. To the extent that UMLLC elects to suspend or cancel a Capital Improvement or Material Change after such Capital Improvement or Material Change has been approved by UMLLC, then (i) in the case of a suspension, any such suspension shall be treated as a UMLLC Directive in accordance with Article 5 and (ii) in the case of a cancellation, (A) any Capital Improvement Costs incurred by the Concessionaire prior to the date of cancellation (including all reasonable and documented demobilization and contractor breakage costs) nonetheless shall be included in the Unrecovered Balance and (B) any costs incurred with respect to such Material Change prior to the date of cancellation (including all reasonable and documented demobilization and contractor breakage costs) nonetheless shall be included in the Uncapped O&M Costs.
- (e) To the extent a proposed Capital Improvement or proposed change in a previously Approved scope or cost of a Capital Improvement is Approved, the Concessionaire shall have the right to (i) deem the cost of such Capital Improvement (up to the Approved amount) or the change in such cost (up to the Approved amount), as applicable, a New Approved Capital Improvement Cost in accordance with Schedule 5 and (ii) include the out-of-pocket costs incurred by the Concessionaire in connection with preparing and submitting a revised request for Approval of such Capital Improvement pursuant to Section 4.3(c)(ii) (if applicable) as part of such New Approved Capital Improvement Cost. The Approved out-of-pocket costs incurred by the Concessionaire pursuant to Section 4.3(c)(ii)(1) in connection with a proposed Capital Improvement or a proposed change in the scope or cost of a previously Approved Capital Improvement that is not Approved shall be included in Uncapped O&M Costs. For any proposed Material Change that is not a Capital Improvement or any proposed change in the scope or cost of a previously Approved Material Change, the out-of-pocket costs incurred by the Concessionaire pursuant to Section 4.3(c)(ii) shall be included in Uncapped O&M Costs.
- (f) After Approval of a proposed Capital Improvement or Material Change or a proposed change in the scope or cost of a previously Approved Capital Improvement or Material Change, the Concessionaire shall make such Capital

Improvement or Material Change in accordance with this Agreement, but subject to Section 4.3(d).

- (g) Notwithstanding anything to the contrary contained in this Section 4.3, to the extent that the Concessionaire incurs any out-of-pocket costs that qualify as operation or maintenance costs (as reasonably determined in accordance with GAAP) in the exercise of its rights and performance of its obligation pursuant to this Section 4.3, the Concessionaire shall have the right to request that UMLLC Approve those costs as a Capital Improvement, and such request shall be a considered a request for Approval of a proposed Capital Improvement; *provided* that, for the avoidance of doubt and without limitation, UMLLC may Approve such costs as a Capital Improvement on the condition that the Capped O&M Amount is equitably reduced to account for the Concessionaire's recovery of such costs by means of the Variable Fee Component instead of the Capped O&M Amount.
- (h) The cost of (i) any Approved Material Changes and (ii) any Approved Capital Improvements that are less than one hundred thousand dollars (\$100,000) (Adjusted for Inflation) will be classified as Uncapped O&M Costs for purposes of calculating the Utility Fee, unless otherwise indicated by UMLLC, in its discretion, in its Approval thereof.

Section 4.4. UMLLC's Capital Plan. The Concessionaire shall reasonably cooperate with UMLLC in the development, modification, and discussion of UMLLC's and the University's capital plans and energy conservation initiatives, including participating with UMLLC's and the University's capital planning and capital plan forecasting processes, attending planning meetings, and, as requested by UMLLC, attending and participating in meetings related to UMLLC's or the University's capital plans.

Section 4.5. Distribution System; Distribution System Capital Improvements.

- (a) *Status of Distribution System as of Turnover Date.* As of the Turnover Date, (i) except as set forth in the definition of Distribution Bottlenecks, the Distribution System is not included in the Utility System or Utility Facilities and (ii) the Utility Services do not include any services in respect of the Distribution System.
- (b) *Initiation of Consideration of Distribution System Capital Improvements.* Either Party may initiate the process by which UMLLC and the Concessionaire will engage with respect to a Distribution System Capital Improvement, as set forth below.
 - (i) *By the Concessionaire.* At any time during the Term, the Concessionaire may, by written notice to UMLLC, request UMLLC to consider whether to invite a proposal from the Concessionaire for Approval of a Distribution System Capital Improvement. Within thirty (30) days of the receipt of such request by the Concessionaire, UMLLC shall determine whether to invite a proposal from the Concessionaire pursuant to Section 4.5(c), which determination shall be made in UMLLC's discretion.

- (ii) *By UMLLC.* At any time during the Term, UMLLC may, by written notice to the Concessionaire, initiate a request for the Concessionaire to prepare a proposal for a Distribution System Capital Improvement pursuant to Section 4.5(c).
- (c) *Proposal for Distribution System Capital Improvement.* Upon the initiation of the request to the Concessionaire to prepare a proposal as set forth in Section 4.5(b), the Concessionaire shall, within sixty (60) days of such request from UMLLC, deliver a proposal to UMLLC requesting Approval of such Distribution System Capital Improvement. The scope of such request for Approval shall be consistent with the requirements for requests for Approval of Capital Improvements as set forth in Section 4.3 as if such proposal was in respect of a Capital Improvement.
- (d) *Negotiation Period.* Following UMLLC's receipt of the proposal for Approval of the Distribution System Capital Improvement pursuant to Section 4.5(c), the Parties shall negotiate in good faith concerning UMLLC's consideration for Approval of such Distribution System Capital Improvement for a period of not less than ninety (90) Days. If the Parties, after such good faith negotiations, do not reach an agreement concerning such Distribution System Capital Improvement, UMLLC shall have the right to pursue such Distribution System Capital Improvement through other means, subject to the rights of the Concessionaire set forth in Section 4.5(e).
- (e) *Concessionaire Right of First Refusal.* If, following the expiration of the good faith negotiation period set forth in Section 4.5(d), UMLLC elects to pursue the financing, funding or construction of such Distribution System Capital Improvement through other means, UMLLC shall have (and shall cause the University to have), prior to entering into any agreement to construct or permit the construction of such Distribution System Capital Improvement, an ongoing obligation (i) to give the Concessionaire notice of the intention to enter into a separate agreement for the construction of such Distribution System Capital Improvement and (ii) to provide the Concessionaire the option to enter into an agreement under substantially the same economic terms (or terms otherwise acceptable to UMLLC, in its discretion) within forty-five (45) Days of such notice.
- (f) *Approval of Distribution System Capital Improvement.* To the extent any Distribution System Capital Improvement is Approved by UMLLC, the cost of such Distribution System Capital Improvement shall be included as a New Approved Capital Improvement Cost in accordance with the terms of Schedule 5. To the extent that any Distribution System Capital Improvement is the subject of an agreement of UMLLC and the Concessionaire pursuant to Section 4.5(e), UMLLC shall pay such compensation to the Concessionaire as set forth in such separate agreement.
- (g) *Addition of Distribution System to Utility System.* Each relevant component of the Distribution System that is constructed or improved as the result of a Distribution System Capital Improvement upon substantial completion of each such

Distribution System Capital Improvement shall be (i) deemed to be part of the Utility System and Utility Facilities for purposes of this Agreement and (ii) included in the Utility System to be operated and the Utility Services to be performed by the Concessionaire under the terms of this Agreement. In addition, with respect to any Distribution System Capital Improvement, the Concessionaire and UMLLC shall determine in good faith the forecasted annual ongoing operations and maintenance costs associated with such Distribution System Capital Improvement and the associated component of the Distribution System that would be then added to the Utility System (or any reductions in current annual ongoing operations and maintenance costs associated therewith), and the Capped O&M Amount shall be increased (or decreased) by such amount.

- (h) Notwithstanding anything in this Agreement to the contrary, UMLLC reserves for itself and the University the right to procure any Distribution System Improvement funded through the capital outlay process outlined in Section 4.1(b) above or in response to an Emergency, in each case without regard to this Section 4.5.
- (i) For the avoidance of doubt, UMLLC shall not be required to comply with this Section 4.5(e) to the extent such compliance by UMLLC would violate applicable Law (in the reasonable opinion of UMLLC, subject to dispute resolution under Article 18).

ARTICLE 5 MODIFICATIONS

Section 5.1. UMLLC Directives. UMLLC may, at any time during the Term, issue a UMLLC Directive to the Concessionaire, which may include (i) the construction of Capital Improvements and the addition to or removal from the Utility System of buildings or other improvements owned, leased, or operated by UMLLC or its Affiliates or (ii) the design, demolition, project management, construction, repair, replacement, remodeling, renovation, reconstruction, enlargement, addition, alteration, painting, or structural or other improvements not included in the Utility Facilities but related thereto. No UMLLC Directive shall have the effect of reducing the components of the Variable Fee Component. Subject to the Concessionaire having obtained (with the cooperation of UMLLC) all relevant Authorizations from all relevant Governmental Authorities required for the relevant work, the Concessionaire shall perform the work required to implement such UMLLC Directive. Utility Facilities constructed as the result of a UMLLC Directive shall be (a) deemed to be part of the Utility System for purposes of this Agreement and (b) included in the Utility System to be operated by the Concessionaire under the terms of this Agreement. To the extent any UMLLC Directive requires the construction of a Capital Improvement, the cost of such Capital Improvement shall be included as a New Approved Capital Improvement Cost up to the Approved cost of such Capital Improvement set forth in UMLLC Directive. To the extent any UMLLC Directive requires the construction of anything other than a Capital Improvement, the costs associated therewith shall be Uncapped O&M Costs in accordance with the definition thereof. In addition, with respect to any UMLLC Directive, the Concessionaire and UMLLC shall determine in good faith the forecasted annual ongoing operations and maintenance costs associated with such UMLLC Directive (or any reductions in current annual ongoing operations and maintenance costs associated therewith), and the Capped

O&M Amount shall be increased or decreased by such amount. To the extent that that an order or directive would be a UMLLC Directive but for the operation of sub-paragraph (4)(y) of the definition of “UMLLC Directive”, and in the event that the Concessionaire notifies UMLLC in writing that it is not willing to carry out such order or directive for such reason: (A) UMLLC may elect to engage a third party to perform the relevant order or directive, and (B) if UMLLC so elects, UMLLC and the Concessionaire shall determine in good faith any corresponding adjustments to the Utility Fee and other provisions of the Concession Agreement that may be required to put the Parties in substantially the same economic position as they were prior to such actions being taken, provided UMLLC shall not be required to compensate the Concessionaire for any benefit that the Concessionaire would have received if it undertook UMLLC Directive. Notwithstanding the foregoing, UMLLC may not issue a UMLLC Directive requiring the construction of a Capital Improvement to the extent that such Capital Improvement was previously the subject of a proposal for Approval submitted by the Concessionaire pursuant to Section 4.3 for a period of twenty-one (21) months following the initial submission of the proposal for Approval of such Capital Improvement; *provided* that this sentence shall apply only to the first such proposal by the Concessionaire and no other proposal with respect to the same or substantially the same Capital Improvement shall restrict UMLLC from issuing a UMLLC Directive hereunder; *provided, however,* nothing in this sentence shall restrict UMLLC from issuing a UMLLC Directive in response to an Emergency.

Section 5.2. Performance of Modifications. Subject to the other provisions of this Article 5, the Concessionaire shall ensure that UMLLC Directives are performed in a good and professional manner and diligently complied with and implemented in accordance with Prudent Industry Practices.

Section 5.3. Addition, Removal and Lease of Property.

- (a) If, after the Turnover Date, the University sells, conveys, leases for a period of time longer than the remaining Term, or otherwise transfers ownership of any real property within the University Campus to a third party unaffiliated with the University, then, contemporaneously with such transfer, the Concessionaire shall disconnect such real property from the Utility System and remove or abandon in place all Utility Facilities and Utility System Assets thereon and shall not be permitted to serve such real property, except if Approved in accordance with Section 3.15(c). However, if UMLLC or the University elects to enter into a concession agreement, ground lease, management agreement, or similar agreement with a third party to operate and maintain any real property that had been part of the University Campus, the Concessionaire shall not be required to disconnect such real property from the Utility System. If such disconnection causes a Capital Improvement that is or had been a New Approved Capital Improvement to be removed from the Utility System, the Capital Improvement shall continue to be included in the Variable Fee Component in accordance with this Agreement as if not removed from the Utility System. The Concessionaire shall reasonably cooperate with UMLLC and the transferee of such real property in such disconnection. In connection therewith, UMLLC and the Concessionaire shall cooperate in good faith to make any reasonably necessary adjustments to the Key

Performance Indicators and the Performance Standards as a result of such sale, conveyance, or lease.

- (b) Due to the fact that the Concessionaire is agreeing to service the University Campus throughout the Term, if, after the Turnover Date, UMLLC or the University currently or thereafter leases, sub-leases, or otherwise provides a leasehold interest in real property served by the Utility System for less than or equal to the period of time remaining in the Term to a third party unaffiliated with the University, then, to the extent that it would not be prohibited by Law, the Concessionaire shall continue to provide Utilities to such real property in accordance with this Agreement, and UMLLC shall remain obligated to pay the Utility Fee attributable to such real property. The Concessionaire is only entitled to the continued receipt of the Utility Fee attributable to such real property and shall have no interests or rights to charge or collect additional payments from UMLLC, the lessees or sub-lessees for the provision of Utilities to such real property.
- (c) UMLLC, at its discretion, may, pursuant to a UMLLC Directive, cause the Concessionaire to provide Utility Services to any portion of the University Campus not served by the Utility System at that time and may expand the definition of the University Campus.

ARTICLE 6 PERFORMANCE STANDARDS

Section 6.1. Compliance with Performance Standards. The Concessionaire shall, at all times during the Term, cause the Utility System Operations to comply with and implement the Performance Standards in all material respects (including any changes or modifications to the Performance Standards pursuant to the terms of this Agreement); *provided* that the Concessionaire shall have a reasonable period of time to comply with the introduction of changes or modifications to the Performance Standards that are made from time to time in accordance with the terms of this Agreement. From and after the date on which the Concessionaire is required to have an Operations Plan pursuant to the Performance Standards, the Concessionaire shall have in place at all times during the Term an Operations Plan. Except as specifically set forth herein, the Concessionaire shall perform all work required to comply with and implement the Performance Standards (including the Capital Improvements described therein) as part of the Utility System Operations and at its sole cost and expense.

Section 6.2. Proposed Performance Standards. If the Concessionaire, at its cost and expense, wishes to implement and use performance standards for the operation of the Utility System other than the Performance Standards, the Concessionaire must provide notice of such proposed performance standards to UMLLC for Approval. The Concessionaire's proposed performance standards must be accompanied by an explanation of the Concessionaire's rationale for making its proposal and all relevant supporting information, certificates, reports, studies, investigations and other materials as are necessary to demonstrate that the Concessionaire's proposed performance standards are reasonably designed to achieve or improve upon the intent of the applicable Performance Standards and are in compliance with Prudent Industry Practices and applicable Laws. UMLLC may request any additional supporting information, certificates,

reports, studies, investigations, and other materials as are reasonably required by UMLLC to determine if the Concessionaire's proposed performance standards are reasonably designed to achieve or improve upon the objectives of the applicable Performance Standards. Until UMLLC provides its Approval for the implementation of the Concessionaire's proposed performance standards, the Concessionaire shall not implement the proposed performance standards and shall implement and comply with the Performance Standards. The Concessionaire's proposed performance standards shall be deemed incorporated into the Performance Standards upon Approval by UMLLC in accordance with the terms hereof. It shall be unreasonable for UMLLC to withhold its Approval if the proposed performance standards are reasonably designed to achieve or improve upon the intent of the applicable Performance Standards in a manner that does not unreasonably increase the cost to UMLLC. If UMLLC refuses to Approve any proposed performance standards and the Concessionaire disagrees with such refusal, the Concessionaire's sole remedy shall be to submit such dispute to the procedures set forth in Article 18.

Section 6.3. Modified Performance Standards.

- (a) The Parties acknowledge that the services provided hereunder by the Concessionaire to UMLLC may impact the quality of life on the University Campus. Because of the importance of maintaining high standards with respect to such campus life, UMLLC shall have the right, at any time during the Term, to modify or change the Performance Standards upon notice to the Concessionaire to (i) comply with any new Law or change in Law applicable to the Utility System Operations, (ii) conform the Performance Standards to standards or practices generally adopted with respect to Comparable Utility Systems or Prudent Industry Practices, or (iii) conform the Performance Standards to a change in the University's design standards after the date hereof of which the Concessionaire did not have, or could not reasonably be expected to have, notice prior to such change taking effect; any such modification shall not constitute a Compensation Event. In the event UMLLC modifies the Performance Standards in accordance with the immediately preceding sentence, the Concessionaire shall promptly perform all work required to implement and shall comply with all such modifications and changes and in no event shall the Concessionaire be excused from compliance with any such modification or change, except as otherwise expressly provided in this Agreement. The cost of such modification or change shall be included in Uncapped O&M Costs (but only to the extent of the costs incurred to cause the Utility System to initially comply with such modification or change) or New Approved Capital Improvement Costs (if such modifications or changes are Capital Improvements). If (x) any such modification or change is a New Approved Capital Improvement and the Concessionaire and UMLLC determine in good faith the amount of the forecasted annual operations and maintenance costs for such New Approved Capital Improvement or (y) such modification or change is not a New Approved Capital Improvement and the Concessionaire and UMLLC determine in good faith the amount of the forecasted annual operations and maintenance costs for such modification or change, then, in either case, the Capped O&M Amount shall increase by such amount. The Concessionaire shall have the right to challenge, pursuant to Article 18, any modified Performance Standard on the grounds that it does not meet the requirement of this Section 6.3(a). In connection with a change

in the Performance Standards under this Section 6.3(a), UMLLC and the Concessionaire shall cooperate in good faith to make any reasonably necessary adjustments to the Key Performance Indicators and any other Performance Standards as a result thereof.

- (b) If, during the Term, UMLLC is of the opinion that a modification or change to the Performance Standards is necessary or desirable but such modification or change is not required by Section 6.3(a), UMLLC may upon reasonable written notice to the Concessionaire modify or change the Performance Standards; *provided, however*, that any such change(s) or modification(s) in the aggregate in a Fiscal Year shall constitute a Compensation Event only if such change(s) or modification(s) (i) are not in response to any action or omission on the part of the Concessionaire or the Operator and (ii) result in an increase, during any Fiscal Year, in operating expenses attributable to compliance with such change(s) or modification(s) (taking into account all such previous changes or modifications applicable in such Fiscal Year or any previous Fiscal Year) in excess of seventy-five thousand dollars (\$75,000) (annually Adjusted for Inflation) which cannot be charged through to UMLLC as an Uncapped O&M Cost or recovered as a New Approved Capital Improvement Cost. At UMLLC's request, the Concessionaire shall perform all work required to implement and shall comply with all such modifications and changes, and in no event shall the Concessionaire be excused from compliance with any such modification or change.
- (c) UMLLC shall have the right to undertake the work necessary to ensure implementation of and compliance with any such modification or change to the Performance Standards if the Concessionaire fails to do so within a reasonable period of time; *provided, however*, that to the extent that such work is undertaken by UMLLC, the Concessionaire shall pay to UMLLC within ten (10) Business Days following demand therefor, or UMLLC may offset from amounts owing to the Concessionaire in connection with such modification or change, (i) with respect to changes pursuant to Section 6.3(a), all costs to comply with such Performance Standard and (ii) with respect to Section 6.3(b), the costs of the portion of the work performed in order to comply with the Performance Standards existing immediately prior to such modification or change, and UMLLC shall be responsible only for the incremental costs of the additional work required in order to implement such proposed modification or change to the Performance Standards and, without duplication with the foregoing, the Concession Compensation with respect to such modification or change.

ARTICLE 7

UTILITY FEE, FIVE-YEAR PLAN, AND ENERGY SUPPLY

Section 7.1. Utility Fee.

- (a) As compensation for the services provided hereunder by the Concessionaire to UMLLC in connection with the Utility System, UMLLC shall pay to the Concessionaire the Utility Fee for each Fiscal Year or portion thereof during the

Term, as determined in accordance with the formula described in Schedule 5 and in the manner set forth in this Section 7.1. At least one hundred eighty (180) Days prior to the commencement of any Fiscal Year during the Term (other than the first (1st) Fiscal Year), the Concessionaire shall provide a forecast of the Utility Fee (as determined in accordance with Schedule 5, and subject to the limitations therein) to UMLLC for the upcoming Fiscal Year (the “Forecast Utility Fee”), provided that the Concessionaire shall, by notice to UMLLC (i) on or before ninety (90) Days prior to the commencement of any Fiscal Year and (ii) again at least ten (10) Days and no more than thirty (30) Days prior to the commencement of such Fiscal Year, adjust such Forecast Utility Fee as necessary, as determined by the Concessionaire in its good faith and reasonable discretion; provided, with respect to the Fiscal Year commencing on the first (1st) July 1 to occur after the Turnover Date, the Concessionaire shall provide the Forecast Utility Fee to UMLLC by the later of one hundred eighty (180) Days before the commencement of the next Fiscal Year and thirty (30) Days after the Turnover Date. UMLLC shall pay the Forecast Utility Fee in twelve (12) equal monthly installments, payable on the first (1st) Day of every month during the Fiscal Year, provided that if the Term expires on a date that is not the last day of a Fiscal Year, the Forecast Utility Fee for that last partial Fiscal Year shall be prorated based on the number of Days in that last Fiscal Year, provided, further, that the first (1st) payment of the Utility Fee shall be made no sooner than one (1) month after the Turnover Date. The Forecast Utility Fee for the first (1st) Fiscal Year of the Term shall be \$[3,360,851.18] prorated based on the number of Days remaining in the first Fiscal Year after the Turnover and payable in equal monthly installments over the number of months remaining in such Fiscal Year. For purposes of providing the Forecast Utility Fee for any Fiscal Year after the first (1st) Fiscal Year, the Parties shall meet in advance and, acting in good faith, shall agree on the methodology for determining the Forecast Utility Fee, including, but not limited to, estimations of the CPI Index for the current Fiscal Year.

- (b) Within sixty (60) Days after the end of each Fiscal Year, the Concessionaire shall deliver to UMLLC a statement (the “Reconciliation Statement”) which states the actual Utility Fee (as determined in accordance with Schedule 5, and subject to the limitations therein) for such Fiscal Year and provides a detailed accounting of each component of the Utility Fee in such Fiscal Year, in each case calculated in a form and with such detail as may be reasonably requested by UMLLC for the determination of the Utility Fee set forth in the Reconciliation. If the Reconciliation Statement reveals that the Utility Fee for a Fiscal Year (as determined in accordance with Schedule 5, and subject to the limitations therein) is more than the Forecast Utility Fee for that Fiscal Year, UMLLC agrees to pay the Concessionaire the difference in a lump sum within thirty (30) Days after receipt of the Reconciliation Statement. If the Reconciliation Statement reveals that the Utility Fee for such Fiscal Year is less than the Forecast Utility Fee for that Fiscal Year, the Concessionaire will pay UMLLC the difference in a lump sum within thirty (30) Days after receipt of the Reconciliation Statement. In addition to the foregoing, the Concessionaire shall deliver to UMLLC the quarterly reporting described in Section 8.1(d).

- (c) The records that the Concessionaire maintains with respect to the calculation of the actual Utility Fee shall be retained by the Concessionaire for a period of five (5) Fiscal Years following the Fiscal Year to which such Utility Fee applied. UMLLC shall have the right, through its Representatives, to examine, copy and audit such records at reasonable times, upon not less than five (5) Business Days' prior notice, at such place within the City of Baton Rouge, Louisiana as the Concessionaire shall reasonably designate from time to time for the keeping of such records. All costs of any such audit shall be borne by UMLLC; *provided, however*, that if such audit establishes that the Utility Fee for the applicable Fiscal Year was lower than the final determination thereof as set forth in the Reconciliation Statement, by at least one percent (1%), then the Concessionaire shall pay the cost of such audit. If, as a result of such audit, it is determined that UMLLC has overpaid the Concessionaire on account of the Utility Fee, then the Concessionaire shall reimburse UMLLC for any (i) undisputed amounts within thirty (30) Days after such determination and (ii) amounts which have been determined to be due pursuant to Article 18 within thirty (30) Days after such determination. If the Concessionaire disputes the results of an audit conducted pursuant to this Section 7.1(c), the Concessionaire's sole remedy shall be to submit such dispute to the procedures set forth in Article 18.
- (d) In addition, if an audit conducted pursuant to Section 7.1(c) establishes that the Utility Fee for the applicable Fiscal Year was lower than the final determination thereof, as set forth in the Reconciliation Statement, by at least three percent (3%), then in addition to paying the cost of such audit and reimbursing UMLLC for the payments in accordance with Section 7.1(c), the Concessionaire shall pay, as liquidated damages, three (3) times the amount of the difference between the Utility Fee and the amount set forth in the Reconciliation Statement. UMLLC and the Concessionaire agree that it would be impracticable and extremely difficult to fix the actual damage to UMLLC if the actual Utility Fee was lower than the amount shown in the Reconciliation Statement by at least three percent (3%). UMLLC and the Concessionaire therefore agree that, in such instance, three (3) times the amount of the difference between the Utility Fee and the amount set forth in the Reconciliation Statement is a reasonable estimate of UMLLC's damages and that UMLLC shall be entitled to said sum as liquidated damages. If the Concessionaire disputes the results of an audit conducted pursuant to Section 7.1(c), the Concessionaire's sole remedy shall be to submit such dispute to the procedures set forth in Article 18.

Section 7.2. Five-Year Plan.

- (a) The Concessionaire shall submit to UMLLC a proposed Initial Five-Year Plan on or before ninety (90) Days following the Turnover Date and shall thereafter submit to UMLLC a proposed Five-Year Plan at least one hundred eighty (180) Days prior to the end of each Fiscal Year during the Term. Each proposed Five-Year Plan shall include the Capital Improvements and Material Changes (and shall identify whether an item requested for Approval is a Capital Improvement or Material Change or a combination thereof) that the Concessionaire proposes to make in each Fiscal Year in such proposed Five-Year Plan as well as anticipated Uncapped O&M

Costs, and the anticipated types of Supplies that will be used for each such Fiscal Year, including the estimated usage pattern over the course of the first Fiscal Year. The initial Five-Year Plan can include, and UMLLC will consider in accordance with Section 4.3, proposed Capital Improvements and Material Changes to the Utility System to address any conditions of the Utility System existing prior to the Turnover Date. Each proposed Five-Year Plan shall be submitted in a format reasonably acceptable to UMLLC as of the date of submission.

- (b) UMLLC shall review and provide comments to the Concessionaire on the proposed Five-Year Plan, provided that to the extent pertaining to proposed Capital Improvements or Material Changes relating to the first full Fiscal Year in the proposed Five-Year Plan, such review and comments shall be conducted and provided in accordance with Section 4.3(c), and provided further that, subject to Section 7.2(c), if UMLLC shall have previously Approved any such Capital Improvement or Material Change included in the proposed Five-Year Plan, UMLLC shall not have the right to modify or rescind such prior Approval to the extent of such prior Approval. The Concessionaire shall promptly incorporate and use UMLLC's comments on the proposed Five-Year Plan to prepare a revised version thereof and submit such revised version to UMLLC. This process shall continue until UMLLC Approves all components of the proposed Five-Year Plan, including the estimated usage of Supplies over the first Fiscal Year in such Five-Year Plan.
- (c) The proposed Five-Year Plan Approved by UMLLC shall become the Approved Five-Year Plan as of the commencement of the first (1st) Fiscal Year in such proposed Five-Year Plan (or, in the case of the proposed Initial Five-Year Plan, as of the date of UMLLC's Approval); *provided, however*, that no portion of an Approved Five-Year Plan related to the second (2nd) through fifth (5th) full Fiscal Years therein shall be deemed Approved by UMLLC, except to the extent that a Capital Improvement or Material Change is scheduled pursuant to such Approved Five-Year Plan to be started in the first (1st) full Fiscal Year and completed in the second (2nd) through fifth (5th) full Fiscal Years therein. For the avoidance of doubt, the Approval of a Five-Year Plan that includes a Capital Improvement or Material Change that is not scheduled to be commenced until the second Fiscal Year therein at the earliest shall not be deemed an Approval of such Capital Improvement or Material Change for purposes of Article 4 or this Article 7.
- (d) If the Concessionaire does not accommodate or otherwise resolve any comment provided by UMLLC pursuant to Section 7.2(b), the Concessionaire shall deliver to UMLLC, within ten (10) Days after receipt of UMLLC's comments, a written explanation as to why accommodation or other resolution of such comment would not allow the Concessionaire to meet the requirements of Section 3.2(a)(ii). The explanation shall include the facts, analyses and reasons that support the conclusion regarding such comment. Any dispute between the Concessionaire and UMLLC over such comment shall be resolved pursuant to the procedures set forth in Article 18.

- (e) If a proposed Five-Year Plan or a portion thereof is not Approved by the commencement of the first (1st) Fiscal Year in such proposed Five-Year Plan, the Approved Five-Year Plan or relevant portion thereof shall continue in effect until a new proposed Five-Year Plan is Approved, provided that in the case of the proposed Initial Five-Year Plan, no Approved Five-Year Plan shall be in effect until the proposed Initial Five-Year Plan is Approved, and provided further that nothing in this Section 7.2 shall permit the Concessionaire to make a Capital Improvement or Material Change except if it is Approved in accordance with Section 4.3(c). Until the initial Five-Year Plan is Approved following the Turnover Date, the Concessionaire shall operate the Utility System in accordance with this Agreement and otherwise in substantially the same manner it had been operated immediately prior to Turnover provided that nothing in this Section 7.2 shall permit the Concessionaire to make a Capital Improvement or Material Change except if it is Approved in accordance with Section 4.3(c).
- (f) For the avoidance of doubt, the Concessionaire's right to receive the Utility Fee, subject to the limitations contained herein and in Schedule 5, shall not be modified or superseded by the Approved Five-Year Plan.
- (g) Except as otherwise provided in Section 7.2(c), the contents of any Approved Five-Year Plan shall not be binding on any future Five-Year Plan.
- (h) Notwithstanding anything to the contrary in this Agreement, the Parties acknowledge and agree that all payments to the Operator pursuant to any agreement between the Concessionaire and the Operator to operate the Utility System that have been previously Approved by UMLLC on or prior to the Turnover Date, shall be deemed Approved and shall require no further Approval for any Five-Year Plan, provided that such payments do not materially differ from the payments or payment mechanics that were Approved by UMLLC in its Approval of the Operator or otherwise.
- (i) In acknowledgement of the importance of the Utility System to the operation of the University Campus and the integrated delivery of services to students, employees, staff, faculty and visitors of the University Campus, UMLLC Liaison and other UMLLC Representatives selected by UMLLC will meet with a representative of the Concessionaire and the Operator on a quarterly basis in order to discuss and assess the implementation of the then-current Five-Year Plan, including any delays or failures to meet the then-current Five-Year Plan and discuss the development of the immediately subsequent Five-Year Plan.

Section 7.3. Energy and Water Supply.

- (a) The Concessionaire shall assist UMLLC with the procurement of sufficient electricity, natural gas, biomass, or other energy supply inputs and domestic water necessary to fully operate the Utility System as set forth in the Performance Standards (the "Supplies"). At UMLLC's direction, assistance may include, but not be limited to, identification and development of Supply procurement

opportunities, provision of market analysis and advice regarding the same, acting on behalf of UMLLC to negotiate or assist in negotiating Supply purchases, acting on behalf of UMLLC, or assisting UMLLC in the operation of bidding mechanisms to procure competitive retail Supplies. UMLLC shall be responsible for paying all Supply Costs directly to the vendor of such Supplies. UMLLC, in connection with its commitment to sustainability, minimization of environmental impact, responsible energy procurement, and its rights and responsibilities as the energy Supply customer of record, shall enter into any contracts with a third party for providing Supplies to the Utility System (each, a “Supply Contract”); *provided* that UMLLC shall have made a reasonable determination that each such Supply Contract is consistent with the then-current Approved Five-Year Plan or has issued a UMLLC Directive with respect to such Supply Contract. UMLLC shall, in its sole discretion, determine the types and sources of the Supplies and the appropriate entity (among the Concessionaire, the Operator and UMLLC) to execute each Supply Contract and, if applicable, any Authorization related to Supplies, with the Concessionaire or Operator executing pursuant to a power of attorney, and the Concessionaire shall operate the Utility System consistent with the types and sources of Supplies determined by UMLLC. In any case, regardless of which entity executes a Supply Contract, the University will be considered as the exclusive customer of the Supplies procured pursuant to this Section 7.3(a) or used for the operation of the Utility System. Notwithstanding the foregoing, the Parties acknowledge that as of the Time of Turnover, there shall be in place certain Supply Contracts to provide Supplies as described in Schedule 6, and the Concessionaire’s obligations under this Section 7.3(a) with respect to the Supplies which are the subject of such Supply Contract shall be met by managing those Supply Contracts until their expiration or termination, at which time the Concessionaire shall be responsible for assisting UMLLC with the procurement of those Supplies for the University Campus as provided herein immediately following the expiration or termination of those Supply Contracts. For the avoidance of doubt, if the third-party supplier of the Supplies fails to deliver such Supplies pursuant to the applicable Supply Contract, (i) such failure shall be a Delay Event (except with respect to any failure to deliver Supplies on UMLLC or University locations outside of the University Campus), (ii) the Concessionaire acting on behalf of UMLLC shall use commercially reasonable efforts to cause such third-party supplier to deliver such Supplies as soon as reasonably practicable, and (iii) as necessary, assist UMLLC with the prompt replacement of such third-party supplier.

- (b) The Concessionaire shall, upon written notice from UMLLC, be responsible for assisting UMLLC with the procurement, billing and/or management of Supplies to UMLLC or its Affiliates on UMLLC or University locations outside of the University Campus, and such assistance with the procurement, billing and/or management of Supplies shall be deemed part of the Utility System Operations. For clarification purposes, the Concessionaire shall be responsible for assisting UMLLC with the management of Supplies under any existing Supply Contract described in Schedule 6 as provided in Section 7.3(a).

- (c) The Concessionaire shall ensure that any Supply Contracts negotiated by the Concessionaire provide that invoices are remitted to the Concessionaire, if so requested by UMLLC in writing, or to such other entity as identified by UMLLC. Promptly after receipt of such an invoice for Supply Costs from a third party but in no event more than five (5) Business Days after receipt thereof, the Concessionaire shall forward the supplier's invoice to UMLLC, and the Concessionaire shall have no obligation to pay such Supply Costs.
- (d) The Concessionaire shall cause the Utility System to be operated using a mix of Supplies supported by the then-current Supply Contracts and the Approved Five-Year Plan. The Concessionaire shall consult UMLLC with respect to any adjustments to the mix of Supplies required to operate the Utility System in accordance with this Agreement and any such adjustments shall only be made upon Approval from UMLLC, which may be withheld in its sole discretion.

Section 7.4. Energy Use Intensity Reduction and Energy Conservation Measures.

In furtherance of the objectives set forth in Section 3.27, within two (2) Years after the Turnover Date, UMLLC shall have the right to request in writing that the Concessionaire diligently prepare and provide to UMLLC a detailed study with recommendations and proposals for opportunities to reduce the energy use intensity on the University Campus, and the Concessionaire shall in good faith discuss with UMLLC the Concessionaire implementing such recommendations and proposals. In addition, in connection with each Five-Year Plan, the Concessionaire may propose certain measures or improvements on the University Campus, including energy conservation measures, buying strategies in connection with Supplies, or such other improvements anticipated to achieve an energy use intensity reduction. UMLLC may consider such proposals in its discretion in connection with reviewing such Five-Year Plan and any Approval of the same may include a shared savings of costs with respect thereto.

**ARTICLE 8
REPORTING; AUDITS; INSPECTIONS**

Section 8.1. Reports; Environmental Incident Management.

- (a) *Incident Management and Notifications.* The Concessionaire shall (i) provide notice to UMLLC of all Emergencies as promptly as possible, and, in any event, not later than six (6) hours after the Concessionaire or the Operator becomes aware of the Emergency, and (ii) promptly provide notice to UMLLC of all material accidents and incidents occurring with respect to the Utility System and of all claims in excess of twenty-five thousand dollars (\$25,000) annually made by or against the Concessionaire or potential claims in excess of twenty-five thousand dollars (\$25,000) annually that the Concessionaire reasonably expects to make against, or to be made against it by, third parties.
- (b) *Environmental Incident Management and Notifications.* The Concessionaire shall provide notice to UMLLC as promptly as possible, and, in any event, not later than six (6) hours after the Concessionaire becomes aware of the Release (accidental or otherwise) of any reportable quantity, as defined under applicable Environmental

Law, of Hazardous Substances occurring with respect to the Utility System or otherwise on the University Campus or any part thereof, which notice shall include the time of such Release, the agencies involved, the damage that has occurred and the remedial action taken. The Concessionaire shall be financially responsible and shall pay the costs and expenses of any remediation required as a result of any such Release of Hazardous Substances caused by the willful misconduct or negligent action of, or permitted by the negligent inaction of, the Concessionaire or any of its Representatives, which costs shall not be recoverable by the Concessionaire as part of the Utility Fee or otherwise pursuant to this Agreement, and the Concessionaire shall not be financially responsible for other Releases of Hazardous Substances from the Utility System. Regardless of the foregoing, unless such Release is an Excluded Liability, the Concessionaire shall be responsible for the remediation of any Releases of Hazardous Substances from the Utility System. The Concessionaire shall not be financially responsible for the actions or inactions of third parties except for (i) those actions or inactions with respect to which the Concessionaire or any of its Representatives shall have had prior knowledge of and could have used commercially reasonable efforts to prevent or mitigate and (ii) those actions or inactions consented in writing to or directed in writing by the Concessionaire or any of its Representatives. As between UMLLC and the Concessionaire, UMLLC shall be designated the generator for the disposal of all Hazardous Substances or other contamination, except for any Hazardous Substances that were Released by the willful misconduct or negligent action of, or permitted by the negligent inactions of, the Concessionaire, the Operator or any of their respective Representatives.

- (c) *Financial Reports.* The Concessionaire shall deliver to UMLLC within one hundred twenty (120) Days after the end of each Fiscal Year a copy of the audited balance sheets of the Concessionaire at the end of each such Fiscal Year and the related audited statements of income, changes in equity and cash flows for such Fiscal Year, including, in each case, the notes thereto, together with the report thereon of the independent certified public accountants of the Concessionaire, in each case in a manner and containing information consistent with the Concessionaire's current practices and certified by the Concessionaire's chief financial officer that such financial statements fairly present the financial condition and the results of operations, changes in equity and cash flows of the Concessionaire as of the respective dates of and for the periods referred to in such financial statements, all in accordance with GAAP or IFRS, provided that if such financial statements are prepared in accordance with IFRS, such financial statements shall include a reconciliation statement setting forth any material discrepancies between IFRS and GAAP reporting with respect to the subject matter thereof. The Concessionaire's independent certified public accountants shall be subject to UMLLC's Approval.
- (d) *Utility Fee Reports.* The Concessionaire shall deliver to UMLLC within thirty (30) Days after the end of each Quarter during a Fiscal Year a report showing (i) the calculation of the Variable Fee Component for that Quarter, (ii) the amount of Uncapped O&M Costs incurred to date for such Fiscal Year, and (iii) the

anticipated expenditures on Capital Improvements and Material Changes for the remainder of such Fiscal Year.

- (e) *Regular Reports.* The Concessionaire shall deliver to UMLLC all reports and information as set forth in the Performance Standards in the time and format described in the Performance Standards.

Section 8.2. Information.

- (a) *Furnish Information.* At the request of UMLLC, the Concessionaire shall, at the Concessionaire's cost and expense and at any and all reasonable times during the Term: (i) make available or cause to be made available (and, if requested by UMLLC, furnish or cause to be furnished) to UMLLC all information relating to the Utility System Operations, this Agreement or the Utility System as may be specified in such request and as shall be in the possession or control of the Concessionaire or its Representatives, and (ii) permit UMLLC, after giving ten (10) Business Days' prior notice to the Concessionaire (which notice shall identify the Persons UMLLC requests to be present for an interview and describe with reasonable specificity the subject matter to be raised in the interview) to request the Concessionaire's approval, which approval shall not be unreasonably withheld, conditioned, or delayed, to discuss the obligations of the Concessionaire under this Agreement with any of the directors, officers, employees or managers of the Concessionaire, the Operator or their respective Representatives at times and places on the University Campus acceptable to all attendees (it being agreed that the Concessionaire shall have the right to be present during any such discussions with the Operator or Representatives of the Concessionaire or the Operator), for the purpose of enabling UMLLC to determine whether the Concessionaire is in compliance with this Agreement. For the avoidance of doubt, this Section 8.2(a) does not impose a requirement to retain information not otherwise retained in the normal course of business or required to be retained by applicable Law.
- (b) *Confidentiality.* Unless disclosure is required by applicable Law, UMLLC shall keep confidential any information obtained from the Concessionaire or its Representatives that constitutes a "trade secret" as defined by applicable Law, as determined by UMLLC in its reasonable discretion. In the event that the Concessionaire seeks to defend an action seeking the disclosure of information that the Concessionaire determines to be confidential pursuant to this Section 8.2(b), UMLLC shall use commercially reasonable efforts to cooperate in such action at no out-of-pocket cost to UMLLC, provided that UMLLC shall not be required to institute any legal action against the requesting party. Notwithstanding anything to the contrary herein, UMLLC and the Concessionaire may disclose the United States federal tax treatment and tax structure of the Transaction.

Section 8.3. Inspection, Audit and Review Rights of UMLLC.

- (a) *Audit Right.* In addition to the rights set out in Section 7.1(c) and Section 8.2, UMLLC may, at all reasonable times, upon ten (10) Business Days' prior notice,

cause a Representative designated by it to carry out an Audit and Review of the information required to be maintained or delivered by the Concessionaire under this Agreement in connection with the performance of the Utility System Operations for the purpose of verifying the information contained therein verifying Utility System Operations and to otherwise track utility usage patterns and shall be entitled to make copies thereof and to take extracts therefrom, at UMLLC's expense but, in any event, subject to Section 8.2(b). The Concessionaire shall, at reasonable times, make available or cause to be made available to UMLLC or its designated Representative such information and material as may reasonably be required by UMLLC or its designated Representative for its purposes and otherwise provide such cooperation as may be reasonably required by UMLLC in connection with the same. Such audits may be made on either a continuous or a periodic basis or both, and may be conducted by (1) employees of the University and/or UMLLC, (2) by independent auditors retained by the University and/or UMLLC, or (3) to the extent required by Law (including La. R.S. 24:511 *et seq.*), by or on behalf of the Louisiana Legislative Auditor or by the Office of the Governor or Division of Administration of the State of Louisiana.

- (b) *Inspection Right.* UMLLC and its Representatives shall, at all reasonable times and upon reasonable prior notice and subject to the Concessionaire's reasonable safety requirements and protocols, have access to the Utility System, the D&C Work, and every part thereof, and the Concessionaire, at the reasonable cost and expense of the Concessionaire, shall and shall cause its Representatives to furnish UMLLC with every reasonable assistance for inspecting the Utility System, the D&C Work, and the Utility System Operations for the purpose of Auditing and Reviewing the information relating to the Utility System Operations and the D&C Work or ascertaining compliance with this Agreement and applicable Law subject to reasonable restrictions on access to confidential and proprietary information as determined by the Concessionaire.
- (c) *Tests.* UMLLC and its Representatives shall, with the prior consent of the Concessionaire, which consent shall not be unreasonably withheld, conditioned or delayed, be entitled, at the sole cost and expense of UMLLC and at any time and from time to time, to perform or cause to be performed, in accordance with Prudent Industry Practices, any test, study or investigation in connection with the Utility System, the D&C Work, or the Utility System Operations as UMLLC may reasonably determine to be necessary in the circumstances, and the Concessionaire, at the cost and expense of the Concessionaire, shall, and shall cause its Representatives to, furnish UMLLC or its Representatives with reasonable assistance in connection with the carrying out of such tests, procedures, studies and investigations.
- (d) *No Waiver.* Failure by UMLLC or its Representatives to inspect, review, test or Audit and Review the Concessionaire's responsibilities under this Agreement or any part thereof, or the performance by the Concessionaire of the Utility Services, or the information relating to the Utility System Operations, shall not constitute a waiver of any of the rights of UMLLC hereunder or any of the obligations or

liabilities of the Concessionaire hereunder. Inspection, review, testing or Audit and Review not followed by a notice of Concessionaire Default shall not constitute a waiver of any Concessionaire Default or constitute an acknowledgement that there has been or will be compliance with this Agreement and applicable Law.

- (e) *No Undue Interference.* In the course of performing its inspections, reviews, tests, and Audits and Reviews hereunder, UMLLC shall minimize the effect and duration of any disruption to or impairment of the Utility System Operations or the Concessionaire's rights or responsibilities under this Agreement, having regard to the nature of the inspections, reviews, tests, and Audits and Reviews being performed, except as necessary in the case of investigations of possible criminal conduct or UMLLC ordinance violations.

Section 8.4. Audits, Assistance, Inspections and Approvals. Wherever in this Agreement reference is made to UMLLC or its Representatives providing assistance, services, Approvals, or consents to or on behalf of the Concessionaire or its Representatives or to UMLLC or its Representatives performing an Audit and Review or inspecting, testing, reviewing, or examining the Utility System, the Utility System Operations or any part thereof or the books, records, Documents, budgets, proposals, requests, procedures, certificates, plans, drawings, specifications, contracts, agreements, schedules, reports, lists, or other instruments of the Concessionaire or its Representatives, such undertaking by UMLLC or its Representatives shall not relieve or exempt the Concessionaire from, or represent a waiver of, any requirement, liability, Concessionaire Default, covenant, agreement, or obligation under this Agreement or at law or in equity and shall not create or impose any requirement, liability, covenant, agreement, or obligation (including an obligation to provide other assistance, services, or Approvals) on UMLLC or its Representatives not otherwise created or imposed pursuant to the express provisions of this Agreement.

Section 8.5. Review and Audit of Costs Relating to D&C Work. Prior to making any progress payments or final payment to the D&C Contractor in respect of the D&C Work pursuant to the terms of the Drop-Down DB Contract, the Concessionaire shall provide UMLLC and its Representatives with the opportunity to review and comment on the relevant draw or payment request from the D&C Contractor for purposes of verifying that the payment amount requested corresponds with the D&C Work performed during the relevant period. UMLLC and its Representatives, as applicable, will provide comments on the relevant draw or payment request within five (5) Business Days of the receipt of same from the Concessionaire. The Concessionaire shall not make payment to the D&C Contractor until UMLLC's comments on the relevant draw or payment request, if any, have been resolved to the satisfaction of UMLLC, acting reasonably. Following IMP Final Acceptance and final payment to the D&C Contractor, UMLLC or its Representatives shall be entitled to carry out an Audit and Review of all payments in respect of the D&C Work made by the Concessionaire to the D&C Contractor pursuant to the terms of the Drop-Down DB Contract in order to, among other things, verify the Capital Improvement Cost of the Initial Modernization Project as compared to the Approved Budgeted Amount for the Initial Modernization Project. Such Audit and Review may be conducted by (1) employees of the University and/or UMLLC, (2) by independent auditors retained by the University and/or UMLLC, or (3) to the extent required by Law (including La. R.S. 24:511 *et seq.*), by or on behalf

of the Louisiana Legislative Auditor or by the Office of the Governor or Division of Administration of the State of Louisiana.

ARTICLE 9 REPRESENTATIONS AND WARRANTIES

Section 9.1. Representations and Warranties of UMLLC. UMLLC makes the following representations and warranties to the Concessionaire and acknowledges that the Concessionaire and its Representatives are relying upon such representations and warranties in entering into this Agreement:

- (a) *Organization.* UMLLC is Louisiana limited liability company.
- (b) *Power and Authority.* UMLLC has (i) duly authorized and approved the execution and delivery of this Agreement and (ii) duly authorized and approved the performance by UMLLC of its obligations contained in this Agreement. UMLLC has the power and authority to enter into this Agreement and to do all acts and things and execute and deliver all other documents as are required hereunder to be done, observed or performed by it in accordance with the terms hereof.
- (c) *Enforceability.* This Agreement has been duly authorized, executed, and delivered by UMLLC and constitutes a valid and legally binding obligation of UMLLC, enforceable against UMLLC in accordance with the terms hereof, subject only to applicable bankruptcy, insolvency, and similar laws affecting the enforceability of the rights of creditors generally and to general principles of equity.
- (d) *Title.* UMLLC has good and sufficient leasehold interest in, pursuant to the University Lease, the Utility Facilities, the Utility System Land, and the Utility System Assets necessary for the Utility System Operations pursuant to this Agreement, subject only to Permitted UMLLC Encumbrances, and is able to transfer or grant such interest to the Concessionaire as provided in this Agreement. Subject to any and all Permitted UMLLC Encumbrances and to the Actual Knowledge of UMLLC, there is no recorded or unrecorded agreement, contract, option, commitment, right, privilege, or other right of another binding upon, or which at any time in the future may become binding upon, UMLLC to sell, transfer, convey, subject to lien, charge, grant a security interest in, or in any other way dispose of or materially encumber the Utility System. Subject to any and all Permitted UMLLC Encumbrances and to the Actual Knowledge of UMLLC, the recorded or unrecorded restrictions, exceptions, easements, rights of way, reservations, limitations, interests, and other matters that affect title to the Utility System (or any portion thereof) do not materially adversely affect the Concessionaire's ability to operate the Utility System in accordance with the terms hereof. No indebtedness for borrowed money of UMLLC is or will be secured by any right or interest in the Utility System or the revenues or income therefrom, and no Person will have any claim or right to, or interest in, any income, profits, rents, or revenue derived by the Concessionaire from or generated with respect to the Utility System (other than the Concessionaire and any claims, rights, or interests

granted by or otherwise relating to the Concessionaire); *provided, however*, the foregoing shall not apply to (i) revenues to which UMLLC is or may be entitled to under this Agreement, (ii) revenues or income derived after the End Date, (iii) revenues or income received by UMLLC from students, or (iv) revenues or income received by UMLLC from third parties as reimbursement for Utilities received by such parties.

- (e) *No Conflicts.* The execution and delivery of this Agreement by UMLLC, the consummation of the Transaction (including the operation of the Utility System in accordance with the terms of this Agreement), and the performance by UMLLC of the terms, conditions, and provisions hereof have not and will not contravene or violate or result in a breach of (with or without the giving of notice or lapse of time, or both) or acceleration of any material obligations (A) of UMLLC under (i) any applicable Law, (ii) any agreement, instrument, or document to which UMLLC is a party or by which it is bound, or (iii) UMLLC's governing documents and (B) to the Actual Knowledge of UMLLC, or the University under (i) any applicable Law, (ii) any agreement, instrument, or document to which the University is a party or by which it is bound, or (iii) the University's governing documents.
- (f) *Consents.* No Consent that has not already been obtained is required to be obtained by UMLLC or, to the Actual Knowledge of UMLLC, the University, from, and no notice or filing that has not already been given is required to be given by UMLLC or, to the Actual Knowledge of UMLLC, the University, to or made by UMLLC or the University with, any Person (including any Governmental Authority) in connection with the execution, delivery, and performance by UMLLC of this Agreement or the consummation of the Transaction, except for such consents which have been obtained and notices which have been given.
- (g) *Compliance with Law; Litigation; Environmental Matters.*
 - (i) UMLLC is not in breach of any applicable Law that would reasonably be expected to have a Material Adverse Effect or a material adverse effect on the Concessionaire. To the Actual Knowledge of UMLLC, (A) UMLLC and the University are in compliance, in all material respects, with the terms and conditions of all Authorizations from Governmental Authorities, (B) no claim has been made by any Governmental Authority to the effect that an Authorization that UMLLC or the University has not obtained is necessary in respect of the operation of the Utility System, and (C) no additional Authorizations from any Governmental Authority are necessary for the operation of the Utility System as currently being operated.
 - (ii) Neither UMLLC nor, to the Actual Knowledge of UMLLC, the University has been served with notice of any action, suit, or proceeding, at law or in equity, or before or by any Governmental Authority, and to the Actual Knowledge of UMLLC, there is no such action, suit, or proceeding pending or threatened against UMLLC or the University, which would reasonably be expected to have a Material Adverse Effect or a material adverse effect

on the Concessionaire. As of the date hereof, there is no action, suit, or proceeding, at Law or in equity, or before or by any Governmental Authority, pending nor, to the Actual Knowledge of UMLLC, threatened against UMLLC or the University which could materially affect the validity or enforceability of this Agreement or the University Lease.

- (iii) To the Actual Knowledge of UMLLC, (a) there is no pending investigation by a Governmental Authority concerning any Release of Hazardous Substances in connection with the Utility System or the Utility Facilities and (b) there has been no Release of Hazardous Substances in connection with the Utility System or the Utility Facilities that could reasonably result in liability to the Concessionaire.
- (h) *Historical Financial Information.* The financial information relating to the Utility System attached hereto as Schedule 9, which identifies operational costs for the periods that ended June 30, 20[●] through June 30, 20[●], to the Actual Knowledge of UMLLC, fairly presents the financial information disclosed thereon in accordance with standard accounting procedures of the University with respect to the Utility System, and is adjusted for anticipated expenditures the Concessionaire will incur to operate the Utility System as it is currently operated.
- (i) *Absence of Changes.* To the Actual Knowledge of UMLLC, since June 30, 20[●], there has not been any transaction or occurrence that has resulted or is reasonably likely to result in a Material Adverse Effect or a material adverse effect on UMLLC.
- (j) *Brokers.* There is no investment banker, broker, finder, or other intermediary which has been retained by or is authorized to act on behalf of UMLLC who might be entitled to any fee or commission from UMLLC in connection with the Transaction. There is also no investment banker, broker, finder, or other intermediary which has been retained by or is authorized to act on behalf of UMLLC who might be entitled to any fee or commission from the Concessionaire in connection with the Transaction.
- (k) *Accuracy of Information.* To the Actual Knowledge of UMLLC, the factual and past historical information regarding the Utility System that UMLLC or the University provided to the Concessionaire through [●] was accurate in all material respects at the time such information was prepared, except to the extent UMLLC removed, revised, or replaced such information prior to the Turnover Date.
- (l) *Undisclosed Defects.* To the Actual Knowledge of UMLLC, there are no material defects of the Utility System that could reasonably be expected to prevent the Utility System from being operated in accordance with the Performance Standards and Prudent Industry Practices.

Section 9.2. Representations and Warranties of the Concessionaire. The Concessionaire makes the following representations and warranties to UMLLC (and

acknowledges that UMLLC is relying upon such representations and warranties in entering into this Agreement):

- (a) *Organization.* The Concessionaire is duly organized, validly existing, and in good standing under the laws of the state of its organization. The capital stock, units, partnership or membership interests, and other equity interests or securities of the Concessionaire (including options, warrants, and other rights to acquire any such equity interests) are owned by the Persons set forth in the written certification that the Concessionaire delivered to UMLLC prior to the date hereof.
- (b) *Power and Authority.* The Concessionaire has the power and authority to enter into this Agreement and to do all acts and things and execute and deliver all other documents as are required hereunder to be done, observed, or performed by it in accordance with the terms hereof.
- (c) *Enforceability.* This Agreement has been duly authorized, executed, and delivered by the Concessionaire and constitutes a valid and legally binding obligation of the Concessionaire, enforceable against it in accordance with the terms hereof, subject only to applicable bankruptcy, insolvency, and similar laws affecting the enforceability of the rights of creditors generally and to general principles of equity.
- (d) *No Conflicts.* The execution and delivery of this Agreement by the Concessionaire, the consummation of the Transaction, and the performance by the Concessionaire of the terms, conditions, and provisions hereof have not and will not contravene or violate or result in a material breach of (with or without the giving of notice or lapse of time, or both) or acceleration of any material obligations of the Concessionaire under (i) any applicable Law, (ii) any material agreement, instrument or document to which the Concessionaire is a party or by which it is bound, or (iii) the articles, bylaws, or governing documents of the Concessionaire.
- (e) *Consents.* No Consent that has not already been obtained is required to be obtained by the Concessionaire from, and no notice or filing that has not already been given is required to be given by the Concessionaire to, or made by the Concessionaire with, any Person (including any Governmental Authority) in connection with the execution, delivery, and performance by the Concessionaire of this Agreement or the consummation of the Transaction, except for such consents which have been obtained and notices which have been given.
- (f) *Compliance with Law; Litigation.* The Concessionaire is not in breach of any applicable Law that could have a Material Adverse Effect. Neither the Concessionaire nor any Affiliate of the Concessionaire is (a) listed on any of the following lists maintained by the Office of Foreign Assets Control of the U.S. Department of the Treasury, the Bureau of Industry and Security of the U.S. Department of Commerce, the Department of State, or their successors or on any other list of Persons with which UMLLC is prohibited from engaging in business under applicable Law: the Specially Designated Nationals and Blocked Persons List; the Sectoral Sanctions Identifications List; the Denied Persons List; the

Unverified List; the Entity List; and solely with respect to the Concessionaire and its parent, the Debarred List; or (b) controlled or fifty percent (50%) or more owned, directly or indirectly, individually or in the aggregate, by one (1) or more Persons on a list identified in clause (a). The Concessionaire has not been served with notice of any suit or proceeding, at law or in equity, or before or by any Governmental Authority, and to the best of the Concessionaire's knowledge, there is no such action, suit, or proceeding threatened against the Concessionaire, which will have a material adverse effect on (i) the Transaction or (ii) the validity or enforceability of this Agreement.

- (g) *Prohibited Tax Shelter Transaction.* The Concessionaire has not entered into, and will not enter into, any lease, sublease, concession, management agreement, operating agreement, or other similar arrangement or other transaction that would cause UMLLC to become a party to a "prohibited tax shelter transaction" within the meaning of Section 4965 of the Code, including by virtue of the execution of this Agreement or any lease, sublease, concession, management agreement, operating agreement, or other similar arrangement or other transaction to which UMLLC has consented to pursuant to the arrangements contemplated by this Agreement.
- (h) *Accuracy of Information.* To the actual knowledge of the Concessionaire, (i) all information regarding the Concessionaire or the Operator provided to UMLLC by or on behalf of the Concessionaire or the Operator was accurate in all material respects at the time such information was provided, and (ii) all information set forth in *[document to be identified]* provided to UMLLC by or on behalf of the Concessionaire or the IMP Contractor was accurate in all material respects at the time such information was provided.
- (i) *Operator; IMP Contractor.*
 - (i) To the extent the Operator is not the Concessionaire, the Concessionaire represents and warrants as follows: (A) the Operator is duly organized, validly existing, and in good standing under the laws of the state of its organization; (B) the capital stock or other equity interests of the Operator (including options, warrants, and other rights to acquire capital stock) is owned by the Persons set forth in the written certification that the Concessionaire delivered to UMLLC prior to the date hereof; (C) the Operator has the power and authority to do all acts and things and execute and deliver all other documents as are required hereunder to be done, observed or performed by it in connection with its engagement by the Concessionaire; (D) the Operator has all necessary expertise, qualifications, experience, competence, skills, and know-how to perform the Utility System Operations in accordance with this Agreement; (e) the Operator is not in breach of any applicable Law that would have a Material Adverse Effect; and (f) is authorized to do business in the State of Louisiana, and, except the extent such licenses and permits are set forth on Schedule 18, has all licenses and permits required to perform its obligations hereunder, which

representations shall be only to the best knowledge of the Concessionaire in the event that the Operator is not an Affiliate of the Concessionaire.

- (ii) To the actual knowledge of the Concessionaire (following reasonable investigation by the Concessionaire), the Concessionaire represents and warrants as follows: (A) the IMP Contractor is duly organized, validly existing, and in good standing under the laws of the state of its organization; (B) the capital stock or other equity interests of the IMP Contractor (including options, warrants and other rights to acquire capital stock) is owned by the Persons set forth in the written certification that the Concessionaire delivered to UMLLC prior to the date hereof; (C) the IMP Contractor has the power and authority to do all acts and things and execute and deliver all other documents as are required hereunder to be done, observed or performed by it in connection with its engagement by the Concessionaire; (D) the IMP Contractor has all necessary expertise, qualifications, experience, competence, skills, and know-how to perform the D&C Work in accordance with this Agreement; (E) the IMP Contractor is not in breach of any applicable Law that would have a Material Adverse Effect; and (F) is authorized to do business in the State of Louisiana, and, except the extent such licenses and permits are set forth on Schedule 18, has all licenses and permits required to perform its obligations hereunder.
- (j) *Brokers.* There is no investment banker, broker, finder, or other intermediary which has been retained by or is authorized to act on behalf of the Concessionaire or any of its Affiliates who might be entitled to any fee or commission in connection with the Transaction which could become a claim on, a liability of, or an Encumbrance on, the Utility System.

Section 9.3. Non-Waiver. No investigations made by or on behalf of any Party at any time shall have the effect of waiving, diminishing the scope of, or otherwise affecting any representation or warranty made by the other Party in this Agreement or pursuant to this Agreement. No waiver by a Party of any condition, in whole or in part, shall operate as a waiver of any other condition.

Section 9.4. Survival.

- (a) *UMLLC's Representations and Warranties.* The representations and warranties of UMLLC contained in Section 9.1 shall survive and continue in full force and effect for the benefit of the Concessionaire as follows: (i) as to the representations and warranties contained in Sections 9.1(a) through 9.1(g), inclusive, without time limit; and (ii) as to all other matters, for a period of twenty-four (24) months following the Turnover Date unless a bona fide notice of a Claim shall have been given, in writing, in accordance with Section 20.1, prior to the expiry of that period, in which case the representation and warranty to which such notice applies shall survive in respect of that Claim until the final determination or settlement of that Claim, provided such determination or settlement is being pursued diligently and in good faith by the applicable Party.

- (b) *Concessionaire's Representations and Warranties.* The representations and warranties of the Concessionaire contained in Section 9.2 shall survive and continue in full force and effect for the benefit of UMLLC as follows: (i) as to the representations and warranties contained in Sections 9.2(a) through 9.2(i), inclusive, without time limit; and (ii) as to all other matters, for a period of twenty-four (24) months following the Turnover Date unless a bona fide notice of a Claim shall have been given, in writing, in accordance with Section 20.1, before the expiry of that period, in which case the representation and warranty to which such notice applies shall survive in respect of that Claim until the final determination or settlement of that Claim, provided such determination or settlement is being pursued diligently and in good faith by the applicable party.
- (c) *Modification of Statutes of Limitations.* The survival periods set forth in this Section 9.4 shall apply with respect to all Claims notwithstanding any statute of limitations or prescriptive period that would be applicable to such Claims under applicable Law. The Parties acknowledge and agree that they intend to modify the statutes of limitations and prescriptive periods with respect to all Claims to the extent such statutes of limitations or prescriptive periods would conflict with the provisions set forth in this Section 9.4.

ARTICLE 10 FINANCE OBLIGATIONS

Section 10.1. Concessionaire's Obligations. The Concessionaire shall be responsible for obtaining any financing for the performance of its obligations under this Agreement, which financing shall comply with all requirements of this Agreement. The Concessionaire shall be permitted to issue additional Leasehold Mortgage Debt or refinance existing Leasehold Mortgage Debt at any time during the Term provided that, as a condition thereof, the Concessionaire must comply with Section 3.6 in connection therewith.

Section 10.2. UMLLC's Obligations. UMLLC shall, to the extent consistent with applicable Law and at the sole cost and expense of the Concessionaire, cooperate with the Concessionaire with respect to documentation reasonably necessary to obtain, maintain, and replace financing for the performance of the obligations of the Concessionaire hereunder. UMLLC's cooperation may include reviewing, Approving, and executing documents which substantiate the terms of this Agreement (including any consents or agreements necessary to confirm that the debt evidenced by the relevant financing constitutes a Leasehold Mortgage Debt) and making information and material relating to the Utility System Operations available to any of the Concessionaire's lenders or proposed lenders to facilitate financing to the extent permitted by applicable Law and contractual obligations with third parties and to the extent reasonable in the circumstances, provided that such lenders and potential lenders shall hold such information in confidence (provided that such lenders and potential lenders may disclose such information to Affiliates and their respective officers, employees, agents, advisors, stockholders, partners, members, accountants, and attorneys to the extent the foregoing agree to maintain such information as confidential in accordance with this Section 10.2 or as may be compelled in a judicial, regulatory (including any self-regulatory organization), or administrative proceeding or as otherwise required by applicable Law or required by any Governmental Authority having jurisdiction over the lender)

and the Concessionaire shall be liable for any disclosure by such lenders or potential lenders in breach thereof. If requested in writing to do so by the Concessionaire, UMLLC shall, at the sole cost and expense of the Concessionaire, use its commercially reasonable efforts to cause UMLLC's independent public accountants to reasonably cooperate in connection with the Concessionaire's public or private offering of securities, as the case may be. In addition, UMLLC shall, promptly upon the request of the Concessionaire or any Leasehold Mortgagee, execute, acknowledge, and deliver to the Concessionaire, or any of the parties specified by the Concessionaire, standard consents and estoppel certificates with respect to this Agreement which may be qualified, after reasonable diligence, to the best of the knowledge and belief of a designated Representative of UMLLC. Nothing herein shall require UMLLC to incur any additional obligations or liabilities (unless UMLLC shall have received indemnification, as determined in UMLLC's discretion, with respect thereto), to take any action or give any consent or enter into any document inconsistent with the provisions of this Agreement.

Section 10.3. Concessionaire's Obligation for Estoppel Certificates. The Concessionaire shall, promptly upon the request of UMLLC, execute and deliver to UMLLC, or any of the parties specified by UMLLC, standard consents and estoppel certificates with respect to this Agreement which may be qualified to the best of the knowledge and belief of a designated Representative of the Concessionaire. Nothing herein shall require the Concessionaire to incur any additional obligations or liabilities or to take any action, give any consent, or enter into any document inconsistent with the provisions of this Agreement or applicable Law.

Section 10.4. Prohibited Tax Shelter Transactions. Consistent with Section 9.2(g), the Concessionaire covenants and agrees that it shall not enter into any lease, sublease, concession, management agreement, operating agreement, or other similar arrangement or other transaction that would cause UMLLC to become a party to a "prohibited tax shelter transaction" within the meaning of Section 4965 of the Code. A violation of this Section 10.4 or a breach of the representation set forth in Section 9.2(g) by the Concessionaire shall entitle UMLLC to (a) recover from the Concessionaire the amount of any Tax liability, penalty, or loss to which UMLLC or any UMLLC official is subject and (b) require the Concessionaire, at the Concessionaire's expense, to prepare timely all statements and returns, and to maintain all lists and similar information that UMLLC becomes obligated to disclose, file, or maintain with any taxing authority or participant or otherwise as a result of such transaction.

ARTICLE 11 COMPLIANCE

Section 11.1. Compliance with Laws. The Concessionaire must at all times at its own cost and expense (but subject to the Concessionaire's express rights hereunder with respect to such costs and expenses, including its right to include the reasonable cost of compliance with any Law enacted after the Turnover Date in the Uncapped O&M Costs in accordance with the definition thereof) observe and comply, in all material respects, and cause the Utility System Operations to observe and comply, in all material respects, with all applicable Laws now existing or later in effect, including those Laws expressly enumerated in this Article 11, and those that may in any manner apply with respect to the performance of the Concessionaire's obligations under this Agreement. For the avoidance of doubt, any costs incurred to comply with applicable Law as a result of any Capital Improvement or other alteration to the Utility System undertaken by the

Concessionaire, shall be at the Concessionaire's cost (subject to inclusion in the Utility Fee as part of the Variable Fee Component or Uncapped O&M Costs, if and as applicable). The Concessionaire shall notify UMLLC within seven (7) Days after receiving written notice from a Governmental Authority that the Concessionaire or the Operator may have violated any Laws.

Section 11.2. Non-Discrimination.

- (a) *Non-Discrimination Requirements.* The Concessionaire shall comply with, and maintain employment policies in a manner consistent with, all applicable Laws regarding equal employment opportunity and non-discrimination in employment, including: (i) the Civil Rights Act of 1964, 42 U.S.C. § 2000 et seq. (1981); (ii) the Civil Rights Act of 1991, P.L. 102-166; (iii) Executive Order Number 11246, 30 Fed. Reg. 12,319 (1965), reprinted in 42 U.S.C. § 2000(e) note, as amended by Executive Order Number 11375, 32 Fed. Reg. 14,303 (1967) and by Executive Order Number 12086, 43 Fed. Reg. 46,501 (1978); (iv) the Age Discrimination Act, 42 U.S.C. §§ 6101-6106 (1981); (v) the Age Discrimination in Employment Act, 29 U.S.C. §§ 621-34 (1967); (vi) the Rehabilitation Act of 1973, 29 U.S.C. §§ 793-794 (1981); (vii) the Americans with Disabilities Act, 42 U.S.C. § 12101 et seq. (1990); (viii) the Uniformed Services Employment and Reemployment Rights Act, 38 U.S.C. § 4301 et seq.; (ix) the Louisiana Human Rights Act, La. R.S. 51:2231 et seq.; and (ix) the Louisiana Employment Discrimination Law, La. R.S. 23:301 et seq.
- (b) *Contract Provisions.* The Concessionaire shall cause all Contractors to comply with each of the federal Laws and Louisiana Laws referenced in this Section 11.2, and shall include a provision to such effect in each contract entered into with any Contractor.

Section 11.3. Compliance with Wage and Hour Laws. The Concessionaire shall comply with all applicable Laws governing employment and/or employee wages and hours, including: (i) the Fair Labor Standards Act, 29 U.S.C. § 201 et seq.; and (ii) the Louisiana Payment of Employees Statute, La. R.S. 23:631 et seq.

Section 11.4. Safety Laws. The Concessionaire shall comply with and maintain employment policies in a manner consistent with all applicable Laws regarding workplace safety, including the Occupational Safety and Health Act of 1970, 29 U.S.C. § 651 et seq.

Section 11.5. Immigration Laws. The Concessionaire shall comply with and maintain employment policies in a manner consistent with all applicable Laws regarding lawful employment of U.S. citizens and non-U.S. citizens, including taking reasonable steps to verify the employment eligibility of all employees as required under such Laws.

Section 11.6. Labor Disputes. The Concessionaire shall take all reasonable steps to resolve any alleged or actual labor dispute between it or the Operator and any representative of its or the Operator's employees; further, any work stoppage or strike resulting from such labor dispute shall not excuse the Concessionaire's performance under this Agreement. The Concessionaire shall use good faith efforts and take immediate steps to effect the limitation and/or removal, by

lawful means, of any pickets or picketing that are the result of an alleged or actual labor dispute between it and any representative of its employees; provided however, if such pickets or picketing results in the obstruction of ingress or egress of any Public Way or UMLLC facility, the Concessionaire shall immediately seek injunctive relief to terminate such pickets or picketing that may be available under applicable Laws.

Section 11.7. Employee Conduct and Performance. The Concessionaire shall ensure that it and the Operator have workplace conduct policies for their employees providing services under this Agreement that are at least as stringent as substantially similar policies and enforcement provisions as those of the University's and UMLLC's general policies for conduct in the workplace and are in accordance with Prudent Industry Practices. These policies shall include policies related to workplace behavior; anti-harassment; weapons; confidentiality; security and safety; possession of alcohol; illegal drugs or weapons in the workplace; violation of criminal statutes that have a direct relationship to work performed by the employee; negligent or incompetent performance of work hereunder; gross misconduct related to work; conduct or interactions with University or UMLLC employees, students or visitors that impair or prejudice the University or UMLLC or their relationship with such persons; and unsafe practices or work performance that create a risk of harm to the employee, other persons or property.

Section 11.8. Non-Collusion. By signing this Agreement, the Concessionaire duly swears, affirms, and warrants that it is the contracting party, and that it has not, nor has any other member, employee, Representative, agent, or officer of the firm, company, corporation, or partnership represented by it, directly or indirectly entered into or offered to enter into any combination, conspiracy, collusion, or agreement to receive or pay any sum of money or other consideration for the execution of this Agreement other than that which appears upon the face of this Agreement.

Section 11.9. Conflict of Interest. The Concessionaire certifies and warrants to UMLLC that neither it nor any of its agents, Representatives, or employees who will participate in any way in the performance of the Concessionaire's obligations hereunder has or, for so long as any such person continues in such capacity, will have any conflict of interest, direct or indirect, with UMLLC during the performance of this Agreement, other than in respect of any disputes that may arise hereunder or in connection herewith.

Section 11.10. Drug-Free Workplace Certification. The Concessionaire hereby covenants and agrees to make a good faith effort to provide and maintain a drug-free workplace. The Concessionaire will give written notice to UMLLC within seven (7) Days after receiving actual notice that the Concessionaire or an employee of the Concessionaire has been convicted of a criminal drug violation occurring in the Concessionaire's workplace.

Section 11.11. Diverse Businesses. The Concessionaire and its Representatives shall use good faith and commercially reasonable efforts to provide opportunities to minority- and women-owned and small and historically underutilized businesses (collectively, "Diverse Businesses") that are either certified by the State or another certifying entity in a diverse category as a contractor, subcontractor, supplier, or capital provider. The Concessionaire and its Representatives shall (i) implement the Diversity, Inclusion and Equity Plan attached hereto as Schedule 17 (the "Diversity Plan"), which Diversity Plan outlines the Concessionaire's commitment and obligation to provide

opportunities to Diverse Businesses, (ii) provide to UMLLC and the University on a quarterly basis during the Term a list of all Diverse Businesses engaged or utilized in connection with any Capital Improvements, including but not limited to the Initial Modernization Project, which list shall identify as to each Diverse Business contained thereon (A) the legal name thereof, (B) the principal office or address thereof, (C) ownership thereof, and (D) the services or good provided or supplied (or to be provided or supplied) and the value of the goods or services procured therefrom, and (iii) following written notice from UMLLC or the University, take all reasonable measures required by the University to ensure accountability, compliance, and transparency in complying with the commercially reasonable, the University system-wide disadvantaged business enterprise goals or policies established by the University's Office of Supplier Diversity. To the extent that any Law would require that this Section 11.11 or comparable language in this Agreement be modified or voided, the Parties agree that such provision can be amended or severed from any such agreement without affecting any of the other terms thereof.

Section 11.12. Accreditation. The Concessionaire shall ensure that the Utility System provides a sufficient quantity of Utilities in a timeframe sufficient such that the University and UMLLC may maintain any third-party accreditation or other third-party standard of which the University or UMLLC have provided the Concessionaire notice prior to the Turnover Date.

Section 11.13. Permits and Other Campus-Wide Authorizations. The Concessionaire acknowledges and agrees that, in connection with the Campus-Wide Permits: (i) UMLLC or the University, as applicable, will continue to be the "owner" identified in the Campus-Wide Permits during the Term; (ii) the Concessionaire will become the "operator" of permitted emission sources from the Utility System identified in the Campus-Wide Permits during the Term, to the extent applicable; (iii) the Concessionaire shall be responsible for operating all emission sources in compliance with all permit and regulatory requirements and meeting all monitoring, recordkeeping and reporting requirements related to such permitted emission sources; (iv) the Concessionaire shall promptly provide to the University's Office of Environmental Health and Safety, as the responsible UMLLC official for communications with the Louisiana Department of Environmental Quality ("DEQ"), all records that the DEQ inspectors request the University or UMLLC provide with respect to the Utility System; and (v) the Concessionaire shall provide to UMLLC (a) complete drafts of all required reports with respect to the Utility System portion of the Campus-Wide Permits for UMLLC to review and Approve at least 15 Business Days prior to the deadline to submit such reports, (b) any information regarding utility operations required for reports related to the Campus-Wide Permits by the later of (1) ten (10) Days after the end of the applicable reporting period and (2) (A) thirty (30) Days prior to the applicable submission deadline or (B) ten (10) Days after a UMLLC request not related to a submission deadline, (c) information to be submitted in connection with the renewal of the regulatory permits or any portion thereof within the time period reasonably established by UMLLC and (d) applications for new permits or modifications to any Campus-Wide Permit for review and Approval at least thirty (30) Days prior to submission to a regulatory agency; and (v) the Parties shall reasonably cooperate with each other in connection with any matters relating to the Campus-Wide Permits. The Concessionaire shall comply with all Campus-Wide Permits to the extent applicable to the Utility System or Utility System Operations.

Section 11.14. Financial and Audit Standards. The Concessionaire shall comply, and its financial statements shall be prepared in accordance, with GAAP or IFRS, provided that if such

financial statements are prepared in accordance with IFRS, such financial statements shall include a reconciliation statement setting forth any material discrepancies between IFRS and GAAP reporting with respect to the subject matter thereof.

Section 11.15. Pay If Paid; Non-Appropriation and Termination.

- (a) *Pay If Paid.* Notwithstanding anything to the contrary contained in this Agreement, whenever a provision in this Agreement provides (i) that the Concessionaire shall only be entitled to compensation in the event and only to the extent that UMLLC receives the corresponding compensation under the University Lease, (ii) that the Concessionaire's entitlement to compensation shall be conditional upon and only to the extent that UMLLC receives the corresponding compensation under the University Lease, (iii) that a payment or other compensation obligation of UMLLC is subject to the Pass-Down Provisions, or (iv) other similar language providing that a payment to the Concessionaire is conditional upon receipt of the relevant amount by UMLLC from the University, including without limitation for purposes of [Section 1.1 "Concessionaire Compensation", Section 2.4(h), Section 3.7(a), Section 3.7(c), Section 3.7(d), Section 3.14, Section 3.21, Section 3.26(d), Section 3.26(g), Section 3.26(h), Section 3.26(i), Section 3.30, Section 4.3(e), Section 4.3(g), Section 5.1, Section 5.3(b), Section 6.3, Section 7.1(b), Section 12.2, Section 13.3, Section 14.1(d), Section 14.2(a), Section 15.1, Section 16.3, Section 16.4, and Section 19.7] of this Agreement, payment of the amount in question by the University to UMLLC pursuant to the University Lease will be strict conditions precedent to the obligation of UMLLC to make a payment to the Concessionaire under the relevant provision of this Agreement.
- (b) *Non-Appropriation.* The Concessionaire acknowledges and agrees that the University's ability to make payments to UMLLC pursuant to the University Lease, and UMLLC's corresponding ability to make payments to the Concessionaire pursuant to this Agreement (including with respect to payment of the Utility Fee), require that the Legislature appropriate to the University funds sufficient therefor and to make such funds available to the University following appropriation. UMLLC (i) has the right, pursuant to the University Lease, to cause the University to include in the University's annual budget request to the Legislature for each fiscal year of the University the funds necessary for payment of the amounts payable by the University to UMLLC pursuant to the University Lease and (ii) agrees to use its best efforts to enforce such right to cause the University to include such amounts in its annual budget request to the Legislature; but makes no representations, warranties or covenants, express or implied, that the Legislature will make such appropriations.
- (c) *Termination.* In the event the Legislature fails to appropriate sufficient moneys that would enable the University to pay its obligations to UMLLC to provide for the continuation of the University Lease and this Agreement, this Agreement shall terminate on the last day of that fiscal year, and the UMLLC shall adopt resolutions stating that there has been an event of non-appropriation. Such termination shall be without penalty or expense to the University or UMLLC; *provided, however,*

that UMLLC shall pay to the Concessionaire the amounts payable to the Concessionaire for termination pursuant to Section 16.4. In such event and for the avoidance of doubt, UMLLC agrees to use its reasonable efforts to cause the University to include in one or more of the University's annual budget request(s) to the Legislature the funds necessary for any such refunds and/or termination fees due the Concessionaire pursuant to this Agreement until such refunds and/or termination fees are paid in full.

ARTICLE 12 PAYMENT OBLIGATIONS

Section 12.1. Certain Payment Obligations of the Concessionaire. To the extent permitted by Law, the Concessionaire shall have a payment obligation to UMLLC and each of its Representatives with respect to the full amount of any Losses actually suffered or incurred (as they are suffered or incurred) by UMLLC or any such Representative, based upon, arising out of, related to, occasioned by or attributable to (i) any failure by the Concessionaire, the Operator, or each of their respective Representatives to comply with, observe, or perform any of the covenants, obligations, agreements, terms, or conditions in this Agreement or, subject to the expiration of the survival period specified in Section 9.4(b), any breach by the Concessionaire of its representations or warranties set forth herein, (ii) any Assumed Liabilities, (iii) any Tax or recording charge attributable to any Transfer of the Concessionaire Interest or any part thereof by the Concessionaire, (iv) any increase in Property Taxes payable by UMLLC that is not included in the definition of Uncapped O&M Costs, or (v) any claim for brokerage commissions, fees, or other compensation by any Person who acted on behalf of the Concessionaire or its Representatives in connection with this Agreement, any Transfer of the Concessionaire Interest or any part thereof, or any other matter affecting the Utility System; *provided, however*, that, except with respect to Claims resulting from Third Party Claims, subject to Section 12.5 Claims shall be made in writing within a period of three (3) Years following the expiration of the Term or earlier termination of this Agreement or within such shorter period as may be prescribed by the applicable statute of limitations or prescriptive period. The Parties agree that the Representatives of UMLLC are intended to be third party beneficiaries of the obligations of the Concessionaire pursuant to this Article 12.

Section 12.2. Certain Payment Obligations of UMLLC. To the extent permitted by Law, and without limiting any other remedy under this Agreement (including Concession Compensation or AA-Compensation as provided in this Agreement) UMLLC shall have a payment obligation to the Concessionaire and each of its Representatives with respect to any Losses actually suffered or incurred by the Concessionaire or any such Representative, based upon, arising out of, related to, occasioned by, or attributable to (i) any failure by UMLLC or any of its employees, officers, or agents (collectively, the "UMLLC Responsible Parties") to comply with, observe, or perform any of the covenants, obligations, agreements, terms, or conditions in this Agreement or, subject to the expiration of the relevant survival period specified in Section 9.4(a), any breach by UMLLC of its representations or warranties set forth herein, (ii) any Excluded Liabilities, (iii) any claim for brokerage commissions, fees, or other compensation by any Person who acted on behalf of UMLLC or any UMLLC Responsible Party in connection with this Agreement or any other matter affecting the Utility System or (iv) any payment of Property Taxes with respect to the Utility System that are not the result of the actions or omissions of the Concessionaire and therefore not

paid to the Concessionaire as Uncapped O&M Costs; *provided, however*, that, except with respect to Claims resulting from Third Party Claims, subject to Section 12.5 Claims are made in writing within a period of three (3) Years following the expiration of the Term or earlier termination of this Agreement or within such shorter period as may be prescribed by the applicable statute of limitations or prescriptive period. The Parties agree that the Representatives of the Concessionaire are intended to be third party beneficiaries of the obligations of UMLLC pursuant to this Article 12.

Section 12.3. Agency for Representatives. Each of UMLLC and the Concessionaire agrees that it accepts each payment obligation contemplated in this Article 12 in favor of any of its Representatives as agent and trustee of that Representative and agrees that each of UMLLC and the Concessionaire may enforce a payment obligation in favor of its Representatives on behalf of that Representative. For purposes of this Section 12.3, the term “Representative”, in the case of the Concessionaire, includes the Leasehold Mortgagee.

Section 12.4. Third Party Claims.

- (a) *Notice of Third Party Claim.* If an Obligee receives notice of the commencement or assertion of any Third Party Claim, the Obligee shall give the Obligor reasonably prompt notice thereof, but in any event no later than 30 Days after receipt of such notice of such Third Party Claim. Such notice to the Obligor shall describe the Third Party Claim in reasonable detail (and include a copy of any complaint or related documents) and shall indicate, if reasonably practicable, the estimated amount of the Loss that has been or may be sustained by the Obligee.
- (b) *Defense of Third Party Claim.* The Obligor may participate in or assume the defense of any Third Party Claim by giving notice to that effect to the Obligee not later than thirty (30) Days after receiving notice of that Third Party Claim (the “Notice Period”). The Obligor’s right to do so shall be subject to the rights of any insurer or other Party who has potential responsibility with respect of that Third Party Claim. The Obligor agrees to pay all of its own expenses of participating in or assuming each defense. The Obligee shall cooperate in good faith in the defense of each Third Party Claim, even if the defense has been assumed by the Obligor and may participate in such defense assisted by counsel of its own choice at its own expense. If the Obligee has not received notice within the Notice Period that the Obligor has elected to assume the defense of such Third Party Claim, the Obligee may assume such defense, assisted by counsel of its own choosing and the Obligor shall be responsible for all reasonable costs and expenses paid or incurred in connection therewith and any Loss suffered or incurred by the Obligee with respect to such Third Party Claim.
- (c) *Assistance for Third Party Claims.* The Obligor and the Obligee will use all reasonable efforts to make available to the Party which is undertaking and controlling the defense of any Third Party Claim (the “Defending Party”), (i) those employees whose assistance, testimony, and presence is necessary to assist the Defending Party in evaluating and in defending any Third Party Claim, and (ii) all Documents, records and other materials in the possession of such Party reasonably

required by the Defending Party for its use in defending any Third Party Claim, and shall otherwise co-operate with the Defending Party. The Obligor shall be responsible for all reasonable expenses associated with making such Documents, records and materials available and for all expenses of any employees made available by the Obligee to the Obligor hereunder, which expense shall not exceed the actual cost to the Obligee associated with such employees.

- (d) *Settlement of Third Party Claims.* If an Obligor elects to assume the defense of any Third Party Claim in accordance with Section 12.4(b), the Obligor shall not be responsible for any legal expenses subsequently incurred by the Obligee in connection with the defense of such Third Party Claim. However, if the Obligor fails to take reasonable steps necessary to defend diligently such Third Party Claim within thirty (30) Days after receiving notice from the Obligee that the Obligee believes on reasonable grounds that the Obligor has failed to take such steps, the Obligee may, at its option, elect to assume the defense of and to compromise or settle the Third Party Claim assisted by counsel of its own choosing and the Obligor shall be responsible for all reasonable costs and expenses paid or incurred in connection therewith. However, the Obligee shall not settle or compromise any Third Party Claim without obtaining the prior written consent of the Obligor unless such settlement or compromise is made without any responsibility to, and does not require any action on the part of, the Obligor and does not in any way affect the Obligor. In the event that the Obligee is UMLLC, in no event may the Obligor settle or compromise any Third Party Claim without obtaining the prior written consent of the Obligee.

Section 12.5. Direct Claims. Any Direct Claim shall be asserted by giving the Obligor reasonably prompt notice thereof, but in any event not later than sixty (60) Days after the Obligee becomes aware of such Direct Claim. The Obligor shall then have a period of thirty (30) Days within which to respond in writing to such Direct Claim. If the Obligor does not so respond within such thirty (30) -Day period, the Obligor shall be deemed to have rejected such Direct Claim, and in such event the Obligee may submit such Direct Claim to the dispute resolution process set forth in Article 18.

Section 12.6. Failure to Give Timely Notice. A failure to give timely notice in accordance with this Article 12 shall not affect the rights or obligations of any Party except and only to the extent that, as a result of such failure, a Party which was entitled to receive such notice was deprived of its right to recover any payment under its applicable insurance coverage or was otherwise directly and materially damaged as a result of such failure. However, this Section 12.6 shall have no effect whatsoever on the survival provisions set out in Section 9.4 and the rights of the Parties with respect thereto.

Section 12.7. Reductions and Subrogation. If the amount of any Loss incurred by an Obligee at any time subsequent to the making of a payment hereunder on account of such Losses (an “Obligation Payment”) is reduced by any recovery, settlement, or otherwise under or pursuant to any insurance coverage, or pursuant to any claim, recovery, settlement, or payment by or against any other Person, the amount of such reduction (less any costs, expenses (including Taxes) or premiums incurred in connection therewith), together with interest thereon from the date of such

recovery, settlement, or reduction at the Bank Rate, shall promptly be repaid by the Obligee to the Obligor. Upon making a full Obligation Payment, the Obligor shall, to the extent of such Obligation Payment, be subrogated to all rights of the Obligee against any third party in respect of the Loss to which the Obligation Payment relates. Until the Obligee recovers full payment of its Loss, any and all claims of the Obligor against any such third party on account of such Obligation Payment shall be postponed and subordinated in right of payment to the Obligee's rights against such third party.

Section 12.8. Payment and Interest. All amounts to be paid by an Obligor hereunder, not including deductibles or self-insured retentions or insurance proceeds, shall bear interest at a rate per annum equal to the Bank Rate, calculated annually and payable monthly, both before and after judgment, from the date that the Obligee disbursed funds, suffered damages or losses, or incurred a loss or expense in respect of a Loss for which the Obligor is responsible to make payment pursuant to this Article 12, to the date of payment by the Obligor to the Obligee.

Section 12.9. Limitation on Certain Claims. To the extent permitted by Law and without limiting any other remedy under this Agreement (including Concession Compensation, AA-Compensation, or KPI Compensation as provided in this Agreement), the maximum aggregate liability of UMLLC to the Concessionaire or its Representatives, in respect of Losses pursuant to this Article 12 shall not exceed the Maximum Budgeted IMP Amount; *provided* that this Section 12.9 shall not apply to Claims for: (i) breach of the representations or warranties in Sections 9.1(a), (b), (c), (d), (e), (f), (g), and (j); (ii) fraud, intentional misrepresentation, or intentional breach of the representations or warranties in Section 9.1; (iii) for any Excluded Liabilities referred to in Section 3.2(d)(iii)(2); (iv) payment of the Utility System Concession Value; and (v) payment of the Utility Fee. To the extent permitted by Law and without limiting any other remedy under this Agreement, the maximum aggregate liability of the Concessionaire to UMLLC and its Representatives, in respect of Losses pursuant to this Article 12 shall not exceed the Maximum Budgeted IMP Amount; *provided further* that this Section 12.9 shall not apply to Claims for the breach of the representations or warranties in Section 9.2(a), (b), (c), (d), (e), (f), (g) and (j) or Section 12.1(iv) or to Claims for fraud, intentional misrepresentation, or intentional breach of the representations or warranties in Section 9.2. Neither Party shall have any liability to the other Party or its Representatives for Losses to the extent resulting from fraudulent actions or gross negligence of the other Party or its Representatives (or UMLLC Responsible Parties in the case of UMLLC). Notwithstanding anything herein to the contrary, the provisions of this Agreement do not waive or abrogate, nor are they intended to waive or abrogate, any limitation of liability for the University or UMLLC provided by Louisiana law, including without limitation under La. R.S. 13:5106.

Section 12.10. Other Matters.

- (a) *Waiver of Limits.* With respect to claims by the Concessionaire's employees, the Concessionaire waives its immunity, if any, to which it is entitled or would be entitled, as a complying employer under the applicable worker's compensation law, but only to the extent that such immunity would bar or affect recovery under or enforcement of the Concessionaire's obligations to defend, indemnify, hold harmless, or contribute to any sums due under any Losses.

- (b) *Losses Net of Insurance.* For purposes of this Article 12, the amount of any Losses for which payment is provided hereunder shall be net of any amounts recovered by the Obligee under insurance policies with respect to such Losses, it being understood that the obligations of the Obligee hereunder shall not be so reduced to the extent that any such recovery results in an increase in the Obligee's insurance premiums, or results in any other additional cost or expense to any such Obligee.

Section 12.11. Offset Rights; Limitations on Certain Damages.

- (a) Each Party's obligations under this Agreement are subject to, and each Party shall have the benefit of, all defenses, counterclaims, rights of offset or recoupment, or other claims and rights, including the right to deduct payments due to the other Party hereunder that are not subject to dispute (collectively, "Offsets"), which such Party may have at any time against such other Party (or any of their respective successors and assigns) or any transferee or assignee of any such other Party's rights as against such Party or any part thereof or interest therein contingent or otherwise, and no transfer or assignment of this Agreement or any other obligation of such other Party, or of any rights in respect thereof, pursuant to any plan of reorganization or liquidation or otherwise shall affect or impair the availability to each Party of the Offsets.
- (b) In no event shall any Party be liable to the other Party under this Agreement for consequential, indirect, exemplary or punitive damages (except for claims for fraud or for intentional misrepresentation or intentional breach).

Section 12.12. Governmental Immunity. Notwithstanding anything herein to the contrary, the Parties acknowledge and agree that UMLLC and its officers, employees, and agents are relying on, and do not waive or intend to waive by any provision of this Agreement, the monetary limitations or any other rights, immunities, and protections provided by Law or otherwise available to UMLLC and its officers, employees, and agents.

Section 12.13. Survival. This Article 12 shall remain in full force and effect in all circumstances and shall not be terminated by any breach (fundamental, negligent or otherwise) by any Party of its representations, warranties or covenants hereunder or by any termination or rescission of this Agreement by any Party.

**ARTICLE 13
INSURANCE**

Section 13.1. Insurance Coverage Required – Concessionaire. The Concessionaire and any sub-contractors of the Concessionaire shall provide and maintain at the Concessionaire's own expense (without limitation of the Concessionaire's right to recover any Uncapped O&M Cost pursuant to clause (o) of the definition thereof), or cause to be maintained, during the Term and during any time period following expiration if the Concessionaire is required to return and perform any additional work, commercially reasonable insurance coverage in accordance with Prudent Industry Practices, including, at a minimum, the insurance coverages and requirements specified below, insuring the Utility System and all Utility System Operations (the

“Concessionaire Required Coverages”). For the avoidance of doubt, Concessionaire Required Coverages may be provided and maintained as part of a corporate insurance program of a direct or indirect holder of equity in the Concessionaire and each of the insurance coverage limits set out in Section 13.1(b), Section 13.1(c), and Section 13.1(d) may be achieved through a combination of primary, excess, and/or umbrella coverage. Any coverage provided under a self-insured program *MUST* first be approved in writing by UMLLC and the University.

- (a) *Workers’ Compensation and Employer’s Liability.* The Concessionaire shall provide or cause to be provided statutory Workers’ Compensation Insurance, to cover liability imposed by Federal and State statutes having jurisdiction over the Concessionaire’s employees engaged in the performance of this Agreement and Employer’s Liability Insurance coverage with limits of not less than \$1,000,000 each employee disease, \$1,000,000 each accident, \$1,000,000 each disease policy limit.
- (b) *Commercial General Liability.* The Concessionaire shall provide or cause to be provided Commercial General Liability Insurance or equivalent with limits of not less than \$1,000,000 per occurrence and \$2,000,000 in the annual aggregate. Coverage shall include the following: bodily injury and property damage including personal injury, coverage for contractual employees (excluding any employees of UMLLC), all premises and on going and completed operations, including blanket contractual and products/completed operations, explosion, collapse, mobile equipment not suitable for roadways, underground, separation of insureds, and liability assumed under an insured contract and shall be written on ISO form CG 00 01 12-07 or its equivalent.
- (c) *Commercial Automobile Liability.* When any motor vehicles (owned, non-owned or hired) are used in connection with work to be performed, the Concessionaire shall provide or cause to be provided Commercial Automobile Liability Insurance with limits of not less than \$1,000,000 combined single limit each accident for bodily injury and property damage. The policy shall be endorsed with CA 99 48 and MCS 90 (or their equivalents), if such exposure exists. The employee versus employee exclusion shall be removed.
- (d) *Umbrella Liability.* The Concessionaire shall provide or cause to be provided follow form Umbrella Liability Insurance with a minimum limit of \$50,000,000 per occurrence and shall apply in excess of the coverages for the Concessionaire Required Coverages set forth in Section 13.1(a), Section 13.1(b) and Section 13.1(c). In the event that such Umbrella Liability Insurance applies in excess of the coverages for the Concessionaire Required Coverage in Section 13.1(e), then the minimum limit for the Concessionaire Required Coverage in Section 13.1(e) shall be \$12,000,000 rather than \$15,000,00, and in the event that such Umbrella Liability Insurance applies in excess of the coverages for the Concessionaire Required Coverage in Section 13.1(g), then the minimum aggregate limit for the Concessionaire Required Coverage in Section 13.1(g) shall be \$10,000,000 rather than \$15,000,000.

- (e) *Professional Liability.* When any architects, engineers, construction managers, professional services providers or any other professional consultants perform work in connection with this Agreement, the Concessionaire shall maintain or require such architects, engineers, construction managers or other professional consultants to maintain Professional Liability Insurance, with limits not less than \$15,000,000 per claim and in the aggregate or such other limit (whether lower or higher) as UMLLC and the Concessionaire may agree (each, acting reasonably) with respect to such policy for a particular Capital Improvement or Material Change, which other limit shall be included as part of the Approval of such Capital Improvement or Material Change in accordance with Section 4.3. The policy shall include: contingent bodily injury liability, rectification and punitive damages. The faulty workmanship exclusion should be modified to cover losses arising out of professional services. Should the Concessionaire self-perform any work of the nature noted in this Section 13.1(e), evidence of Professional Liability Insurance meeting the standards for such work set forth above shall be required. Such insurance *shall remain* in place following completion of turnover date through the timing set forth in the applicable statute of repose.
- (f) *Network Security and Privacy Insurance.* The Concessionaire shall also maintain Cyber Liability Insurance for network security and privacy liability with limits of not less than \$10,000,000 per claim and in the aggregate inclusive of cybersecurity event management. Additionally coverage shall include: naming UMLLC and the University as Additional Insureds, \$10,000,000 per claim/aggregate Business Income/Network Interruption coverage, system failure cover, cyber extortion full limits, and physical damage ensuing from a cyber attack. When policies are renewed or replaced, the policy retroactive date shall coincide with, or precede, start of work in connection with this Agreement.
- (g) *Pollution Legal Liability.* The Concessionaire shall provide Pollution Legal Liability Insurance and Site Pollution Insurance (third party or first party) or cause to be provided Pollution Legal Liability Insurance or Site Pollution Insurance (third party or first party) or equivalent, in each case with limits of not less than \$10,000,000 per incident and \$15,000,000 in the aggregate during any 3 year period for environmental and pollution damage liability arising out of pollution events occurring after the Turnover Date.
- (h) *Property.* The Concessionaire shall obtain All Risk Property Insurance at full replacement cost, covering all loss, damage or destruction to the Utility System (including improvements and betterments and excluding any building in which the Shared Spaces are located), which insurance may be provided on a blanket basis with reported building values, which shall include the value of the coverage for the Utility System; provided, however, that the limits of such coverage may be based on replacement cost value agreed by UMLLC and the University and the Concessionaire acting reasonably or on a probable maximum loss analysis, subject to UMLLC's and the University's approval of such probable maximum loss analysis by an independent third party that is reasonably acceptable to UMLLC. Coverage shall include the following, but not be limited to: equipment breakdown,

collapse, water including overflow, leakage, sewer backup or seepage, utility interruption, debris removal, business ordinance or law for increased cost of construction, extra expense, boiler and machinery, valuable papers and, to the extent commercially available, earthquake, flood, ground up terrorism (certified and non-certified) and named wind including storm surge. Coverage shall include flood insurance with a sublimit of not less than \$10,000,000 in the aggregate. UMLLC and the University and any Leasehold Mortgagee shall be named as Additional Insureds and as loss payees. The Concessionaire shall be responsible for any loss or damage to UMLLC property caused by the Concessionaire or its Representatives at full replacement cost, except to the extent such loss or damage is covered by the insurance described in Section 13.2(c), in which case the Concessionaire shall be responsible for the deductible only in accordance with Section 13.2(c) as well as any uninsured damages resulting from direct or indirect peril.

- (i) *All Risk Builder's Risk.* When the Concessionaire undertakes, pursuant to this Agreement, any construction, maintenance or repairs to the Utility System (including Capital Improvements, Material Changes and betterments), the Concessionaire shall provide or cause to be provided, All Risk Builder's Risk Insurance at replacement cost for materials, supplies, equipment, machinery and fixtures that are or will be part of the Utility System. Coverage shall include, but not be limited to, the following: right to partial occupancy, boiler and machinery, business income, valuable papers, ground up terrorism (including certified and non-certified incidents), and other consequential loss, when applicable with aggregate sublimits for catastrophic perils of earthquake, flood and named wind including storm surge which are the best available on commercially reasonable terms. UMLLC and the University and any Leasehold Mortgagee may be named as Additional Insured and as loss payees and included in any claim payment for signature prior to execution of the payment.
- (j) The Concessionaire's insurance, including Contractors and sub-contractors shall be primary and any insurance or self-insurance carried by UMLCC and/or the University shall not contribute with it. Any limits carried by the Concessionaire in excess of the required limits shown herein shall be available to UMLCC and the University..

Section 13.2. Insurance Coverage Required – UMLLC. UMLLC shall provide and maintain at UMLLC's own expense, or cause to be maintained, during the Term and during any time period following expiration if the Concessionaire is required to return and perform any additional work, the following insurance coverages and requirements specified below (the "UMLLC Required Coverages" together with the Concessionaire Required Coverages, the "Required Coverages").

- (a) *Workers' Compensation.* UMLLC shall provide or cause to be provided Workers' Compensation coverage, as prescribed by applicable Law, covering all UMLLC employees who agree to provide a service under this Agreement.

- (b) [*UMLLC Liability Coverage.* UMLLC's liability coverage administered by the State's Office of Risk Management.]
- (c) *Property.* UMLLC shall obtain All Risk Property Insurance at full replacement cost, covering all loss, damage or destruction to UMLLC's or the University's owned property (other than any property leased to the Concessionaire hereunder), including improvements and betterments and the buildings in which the Shared Spaces are located, which insurance may be provided on a blanket basis with reported building values, which shall include the value of the coverage for UMLLC's owned property required hereunder; provided, however, that the limits of such coverage may be based on replacement cost value. Coverage shall include the following: equipment breakdown, collapse, water including overflow, leakage, sewer backup or seepage, utility interruption, debris removal, business ordinance or law for increased cost of construction, extra expense, boiler and machinery, valuable papers and, to the extent commercially available, earthquake and named wind. Coverage shall include flood insurance with limits which are commercially available. The Concessionaire shall be responsible for the property deductible payable by UMLLC and/or the State of Louisiana for any loss or damage to UMLLC property caused by the Concessionaire or its Representatives.

Section 13.3. Additional Requirements.

- (a) *Evidence of Insurance.* The Parties shall deliver or cause to be delivered to each other's Representative designated in writing by each Party and to the University's representative as noticed to the Concessionaire, an original, latest edition standard ACORD form Certificates of Insurance, or equivalent documentation acceptable to the Parties, evidencing the Concessionaire Required Coverages or UMLLC Required Coverages, as applicable, on or before the Turnover Date, and shall provide or cause to be provided, promptly following renewal and not more than 14 Business Days following renewal of the then current coverages (or such other period as is agreed to by the Parties), Renewal Certificates of Insurance, or such similar evidence, if such coverages have an expiration or renewal date occurring during the Term. The receipt of any certificate does not constitute agreement by the receiving party that the insurance requirements in this Agreement have been fully met or that the insurance policies indicated on the certificate are in compliance with all requirements of this Agreement. The failure of either Party to obtain certificates or other insurance evidence from the other Party shall not be deemed to be a waiver by such Party. Non-conforming insurance shall not relieve either Party of the obligation to provide insurance as specified herein.
- (b) *Notice of Cancellation or Violation.* Each carrier shall be required to notify the Certificate Holder, including the University, of notice of cancellation in accordance with policy provisions, and each Party to this contract shall notify the other Party in writing 30 Days (or in the case of cancellation for non-payment of premiums, 10 Days) prior to cancellation, non-renewal or any material change of any UMLLC Required Coverages (in the case of UMLLC) or Concessionaire Required Coverages (in the case of the Concessionaire). Without limiting Section 13.3(g),

UMLLC shall be permitted (but not obligated) to pay any delinquent premiums before the cancellation date specified by the insurer in any notice of cancellation for non-payment of premium in order to maintain such coverage in full force and effect and the Concessionaire shall reimburse UMLLC for any delinquent premiums paid by UMLLC on demand without any Days of grace and without prejudice to any other rights and remedies of the Parties hereunder.

- (c) *Deductibles.* All deductibles or self-insured retentions for Concessionaire Required Coverages or Concessionaire Contractors in excess of \$200,000 (Adjusted for Inflation annually) shall not exceed amounts approved by UMLLC in writing. Except as expressly provided herein, any and all deductibles or self-insured retentions on Required Coverages shall be borne by the purchasing Party or its Contractors, who shall be responsible for its own deductibles and/or self-insured retentions unless the Party is at fault for a loss to the other Party in which case the at fault party will pay the other Party's deductible or self-retention.
- (d) *Adjustment of Insurance Coverages.* The amounts of coverage required by Section 13.1 and Section 13.2 shall be reasonably adjusted, as agreed by UMLLC, the University and the Concessionaire, based on limits maintained for comparable property each succeeding fifth anniversary of the Turnover Date, but in no event shall the amounts of coverage be less than specified in Section 13.1 and Section 13.2.
- (e) *Waiver of Subrogation.* Each of the Required Coverages provided by the Concessionaire pursuant to this agreement (other than those set forth in Section 13.2(a) and Section 13.2(b)) shall, where legally or customarily permitted, include a waiver by the insurer of its rights of subrogation against the other, its employees, elected officials, agents or Representatives (and, in the case of the Concessionaire Required Coverages, against the State of Louisiana; UMLLC, the University, their agents, officials, and employees. The Concessionaire shall cause each of its Contractors and subcontractors to waive all their rights of subrogation against the State of Louisiana; UMLLC, the University their agents, officials, and employees.
- (f) *UMLLC's Right to Insure.* Without limiting Section 13.3(b), if the Concessionaire fails to obtain and maintain or cause to be obtained and maintained the Concessionaire Required Coverage in accordance with this Article 13, UMLLC shall have the right (without any obligation to do so), upon 2 Business Days' notice to the Concessionaire in a non-emergency situation or forthwith in an emergency situation and without assuming any obligation in connection therewith, to effect such insurance and all costs and expenses in connection therewith shall be payable by the Concessionaire on demand without any Days of grace and without prejudice to any other rights and remedies of UMLLC hereunder. Such insurance taken out by UMLLC shall not relieve the Concessionaire of its obligations to insure hereunder and UMLLC and the University shall not be liable for any loss or damage suffered by the Concessionaire in connection therewith.

- (g) *No Limitation as to Concessionaire Liabilities.* The Concessionaire expressly understands and agrees that any coverages and limits furnished by the Concessionaire shall in no way limit the Concessionaire's liabilities and responsibilities specified within this Agreement or by Law.
- (h) *No Contribution by UMLLC.* The Concessionaire expressly understands and agrees that any insurance or self-insurance programs maintained by UMLLC, the State of Louisiana, or the University shall not contribute with insurance provided by the Concessionaire under this Agreement.
- (i) *Insurance Requirements of Contractors.* The Concessionaire shall require in each contract with any Contractor that such Contractor obtain coverages reasonably comparable to the Concessionaire Required Coverages that are reasonably appropriate in their limits and other terms and conditions, in each case to the nature of the contract with the Contractor. Such coverages shall insure the interests of the State of Louisiana, UMLLC, the University, their agents, officials, and employees (provided that such agents, officials or employees shall not be included if not permitted by applicable Law or commercially available), the Concessionaire and any other Contractors in respect of the applicable work being performed and shall be subject to the same (or comparable) coverage and administrative requirements as are imposed on the Concessionaire pursuant to this Agreement, specifically requiring such Contractor to name the State of Louisiana, the University, UMLLC, their agents, officials and employees as Additional Insureds and requiring such Contractor's insurance to include a waiver of subrogation as described in Section 13.3(f). When requested to do so by UMLLC or the University, the Concessionaire shall provide, or cause to be provided, to UMLLC Certificates of Insurance with respect to such insurance coverages or such other evidence of insurance, as may be reasonably acceptable in form and content to UMLLC.
- (j) *Cooperation.* UMLLC and the Concessionaire shall do all acts, matters and things as may be reasonably necessary or required to expedite the adjustment of any loss or damage covered by insurance hereunder so as to expedite the release and dedication of proceeds of such insurance in the manner and for the purposes herein contemplated.
- (k) *Joint Venture and Limited Liability Company Policies.* If the Concessionaire or any Contractor required to obtain an insurance policy hereunder is a joint venture or limited liability company, all insurance policies required to be obtained by the Concessionaire or such Contractor shall specifically name the joint venture or limited liability company as a named insured. If the Concessionaire contracts operations to a third party, the Concessionaire will be an additional insured on any liability policy.
- (l) *Other Insurance Obtained by Concessionaire.* If the Concessionaire or its Contractors desire coverages in addition to the Concessionaire Required Coverages, the Concessionaire and each Contractor shall be responsible for the acquisition and cost of such additional coverages. If the Concessionaire or its

Contractors obtain any property, liability or other insurance coverages that will relate to the Utility System or the Utility System Operations in addition to the Concessionaire Required Coverages (“Additional Coverages”), then the Concessionaire or its Contractors shall (i) notify UMLLC as to such Additional Coverages at least 10 Business Days in advance of purchasing such Additional Coverages and make such modifications as UMLLC may reasonably require so that such Additional Coverage does not conflict with UMLLC’s insurance coverages, (ii) provide UMLLC with any documentation relating to the Additional Coverages, including Certificates of Insurance, that UMLLC reasonably requests and (iii) at UMLLC’s election, acting reasonably, cause the State of Louisiana, the University, UMLLC, their agents, officials and employees, to be named as additional insureds under such Additional Coverages, if that is normally allowed in accordance with good industry practice.

- (m) *UMLLC’s Right to Modify.* UMLLC shall have the right, acting reasonably, to request to modify, delete, alter or change insurance coverage requirements set forth in Section 13.1 and this Section 13.3. Notwithstanding anything to the contrary herein, (i) any change to the types or limits of contractually required insurance coverage shall be subject to mutual agreement of the Parties, each acting reasonably, and (ii) if any insurance (including the limits or deductibles thereof) required to be maintained under this Agreement shall not be available at commercially reasonable rates, the Concessionaire’s obligation to obtain or maintain such insurance shall be waived by UMLLC for as long as such insurance shall not be available at commercially reasonable rates, provided that during the period of such waiver, the Concessionaire maintains the maximum amount of such insurance otherwise available at commercially reasonable rates.
- (n) *Commercial Availability.* To the extent any of the Required Coverages are not available on a commercially reasonable basis or on commercially reasonable terms, the Party responsible for obtaining such Required Coverage shall obtain insurance that is available on a commercially reasonable basis or on commercially reasonable terms that best approximates the applicable Required Coverages, but said substitute coverage shall, at the other Party’s request, be subject to review of an independent insurance consultant, and such independent insurance consultant shall have delivered to UMLLC and the Concessionaire its opinion to the effect that the substitute coverages meet the above-stated criteria.
- (o) *Endorsements.* All Concessionaire Required Coverages (except for the professional liability, workers’ compensation and employer’s liability policies) shall be endorsed to include the State of Louisiana, UMLLC, the University, their agents, officials, and employees as Additional Insureds, in each case to the extent permitted by Law and commercially available. For the avoidance of doubt, Blanket Additional Insured endorsements that provide coverage “where required by contract” shall be acceptable for this purpose. The General Liability Additional Insured provisions will include both on-going and completed operations and confirmed accordingly in the Certificates of Insurance.

- (p) *Concessionaire Required Coverage Requirements.* All Concessionaire Required Coverages and UMLLC's All Risk Property Insurance described in Section 13.2(c) shall be issued by reputable insurance companies duly authorized to engage in the insurance business in the State of Louisiana, with an A.M. Best's rating of A-, VII or better, be primary noncontributory coverage and contain severability of interests provisions.
- (q) *Defense of Coverage Outside Limits of Liability.* All Concessionaire Required Coverages shall include defense coverage outside the limits of liability, except for the Professional Liability Insurance required to be carried by the Concessionaire.
- (r) *Requirements for Concessionaire Required Coverages for Liability Policies.* All Concessionaire Required Coverages that are liability policies shall be occurrence-based, except where not commercially available, in which case they shall be on a claims-made basis, provided that such policies shall extend for a period of 5 years after the expiration or earlier termination of this Agreement, which obligation shall survive the expiration or earlier termination of this Agreement.
- (s) *Payment for Insurance Coverage.* To the extent that UMLLC and the Concessionaire determine that it would be in the best interests of both Parties for any of the Concessionaire Required Coverages to be purchased by and held in the name of UMLLC, then UMLLC shall be responsible for purchasing those certain Concessionaire Required Coverages, which shall satisfy the Concessionaire's obligation to do so hereunder. UMLLC shall name the Concessionaire and the Leasehold Mortgagee as additional insureds thereunder.

Section 13.4. Damage and Destruction.

- (a) *Obligations of Concessionaire.* If all or any part of any of the Utility System shall be destroyed or damaged during the Term in whole or in part by fire or other casualty of any kind or nature (including any casualty for which insurance was not obtained or obtainable), ordinary or extraordinary, foreseen or unforeseen, the Concessionaire shall:
 - (i) give UMLLC notice thereof promptly after the Concessionaire receives actual notice of such casualty;
 - (ii) at its sole cost and expense, whether or not insurance proceeds, if any, shall be equal to the estimated cost of repairs, alterations, restorations, replacement and rebuilding (the "Casualty Cost"), which for the avoidance of doubt shall not be included in the Utility Fee, proceed diligently to repair, restore or rebuild the same to the condition existing prior to the happening of such fire or other casualty or with such modifications, including as to location or configuration, as directed by UMLLC provided such modifications shall not materially and adversely affect the Concessionaire's ability to perform the Utility System Operations once completed and such

cost shall be included in the Casualty Costs (any such activity being a “Restoration”); and

- (iii) if the Casualty Cost cumulatively exceeds \$1,000,000, deposit all insurance proceeds received by the Concessionaire in connection with the relevant Restoration with the Depository selected by UMLLC pursuant to Section 13.4(b); provided, however, that if at any time the Casualty Cost exceeds the net insurance proceeds then deposited with the Depository, then the Concessionaire shall also deposit with the Depository such cash as is sufficient to cover the difference between the Casualty Cost and the net insurance proceeds deposited pursuant to this Section 13.4(a)(iii) and Section 13.4(b) (the “Restoration Shortfall Amount”), except to the extent such difference is caused by the negligence or willful misconduct of, or violation of applicable Law by, UMLLC or is the result of any modifications made by UMLLC pursuant to Section 13.4(a)(ii) in which case UMLLC shall be responsible to make such deposit (collectively, with (A) any insurance proceeds received by the Concessionaire with respect to such Casualty not on deposit with the Depository and (B) any interest earned on all such funds, the “Restoration Funds”).

Any Restoration undertaken pursuant to this Section 13.4 shall be undertaken in accordance with and subject to the terms of this Agreement. Prior to the commencement of Restoration work, the Concessionaire shall submit to UMLLC for Approval by UMLLC the plans for the Restoration work and such work shall not be undertaken unless the plans for such work have been Approved by UMLLC in writing. For the avoidance of doubt, and notwithstanding any direction by UMLLC to modify the location or configuration of the Utility System pursuant to Section 13.4(a)(ii), the Restoration Shortfall Amount shall not be considered a New Approved Capital Improvement Cost.

- (b) *Rights of UMLLC.* If (i) the Concessionaire shall fail or neglect to commence the diligent Restoration of the Utility System or the portion thereof so damaged or destroyed, (ii) having so commenced such Restoration, the Concessionaire shall fail to diligently complete the same in accordance with the terms of this Agreement or (iii) prior to the completion of any such Restoration by the Concessionaire, this Agreement shall expire or be terminated in accordance with the terms of this Agreement, UMLLC may, but shall not be required to, complete such Restoration at the Concessionaire’s expense and shall be entitled to be paid out of the Restoration Funds, but such payment shall not limit the Concessionaire’s obligation to pay UMLLC’s reasonable Restoration expenses, less amounts received by UMLLC from such Restoration Funds. In any case where this Agreement shall expire or be terminated prior to the completion of the Restoration, the Concessionaire shall (x) account to UMLLC for all amounts spent in connection with any Restoration which was undertaken, (y) pay over or cause the Depository to pay over to UMLLC within 30 Days after demand therefor, the remainder, if any, of the Restoration Funds received by the Concessionaire prior to such termination or cancellation and (z) pay over or cause the Depository to pay over to UMLLC,

for allocation to UMLLC, within 30 Days after receipt thereof, any Restoration Funds received by the Concessionaire or the Depository subsequent to such termination or cancellation. The Concessionaire's obligations under this Section 13.4(b) shall survive the expiration or termination of this Agreement.

- (c) *Payment of Restoration Funds to Concessionaire.* Subject to the satisfaction by the Concessionaire of all of the terms and conditions of this Section 13.4, the Depository shall pay to the Concessionaire from time to time, any Restoration Funds then held by the Depository, but not more than the amount actually collected by the Depository upon the loss, together with any interest earned thereon, after reimbursing itself therefrom, as well as UMLLC, to the extent, if any, of the reasonable expenses paid or incurred by the Depository and UMLLC in the collection of such monies, to be utilized by the Concessionaire solely for the Restoration, such payments to be made as follows:
- (i) prior to commencing any Restoration, the Concessionaire shall furnish UMLLC with an estimate of the cost of such Restoration, prepared by an architect or engineer;
 - (ii) the Restoration Funds then held by the Depository shall be paid to the Concessionaire in installments as the Restoration progresses, subject to Section 13.4(c)(iii), based upon requisitions to be submitted by the Concessionaire to the Depository and UMLLC in compliance with Section 13.4(d), showing the cost of labor and materials purchased for incorporation in the Restoration, or incorporated therein since the previous requisition, and due and payable or paid by the Concessionaire; provided, however, that if any lien (other than a Permitted Concessionaire Encumbrance) is filed against the Utility System or any part thereof in connection with the Restoration, the Concessionaire shall not be entitled to receive any further installment until such lien is satisfied or discharged (by bonding or otherwise); provided further that notwithstanding the foregoing, but subject to the provisions of Section 13.4(c)(iii), the existence of any such lien shall not preclude the Concessionaire from receiving any installment of Restoration Funds so long as such lien will be discharged with funds from such installment and at the time the Concessionaire receives such installment the Concessionaire delivers to UMLLC and the Depository a release of such lien executed by the lienholder or and in recordable form;
 - (iii) the amount of any installment to be paid to the Concessionaire shall be the amount of Restoration Funds incurred by the Concessionaire in connection therewith, less 10% of such amount as a retainage (which 10% retainage shall (i) be reserved without duplication of any retainage reserved by the Concessionaire under its contracts for the Restoration work and (ii) shall be released to the Concessionaire upon completion of the Restoration work), except that such retainage shall not include any amounts for architects' or engineers' fees or permitting or other governmental fees in connection with the Restoration or with respect to each Contractor upon the final completion

of each such Contractor's respective work, provided that the unapplied portion of the funds held by the Depository are sufficient to complete the Restoration; provided, however, that all disbursements to the Concessionaire shall be made based upon an architect's or engineer's certificate for payment in accordance with industry standards, and disbursements may be made for advance deposits for materials and Contractors to the extent that such disbursements are customary in the industry and provided that the unapplied portion of the funds held by the Depository are sufficient to complete the Restoration; and

- (iv) except as provided in Section 13.4(b) and subject to Section 13.4(h), upon completion of and payment for the Restoration by the Concessionaire, the Depository shall pay the balance of the Restoration Funds, if any, to the Concessionaire; provided, however, that if the insurance proceeds are insufficient to pay for the Restoration (or if there shall be no insurance proceeds), the Concessionaire shall nevertheless be required to make the Restoration, provided the deficiency in funds necessary to complete the Restoration is provided in accordance with Section 13.4(a)(iii).

For the avoidance of doubt, the costs incurred for Capital Improvements made as part of the Restoration shall not be considered Capital Improvement Costs for purposes of Schedule 5 or otherwise included in the calculation of the Utility Fee.

- (d) *Conditions of Payment.* The following shall be conditions precedent to each payment made to the Concessionaire as provided in Section 13.4(c):
 - (i) at the time of making such payment, no Concessionaire Default exists, except if such Concessionaire Default is the result of the damage or destruction for which such payment is being made;
 - (ii) the Restoration shall be carried out under the supervision of the architect or engineer, and there shall be submitted to the Depository and UMLLC the certificate of the architect or engineer (or other evidence reasonably satisfactory to UMLLC) stating that (A) the materials and other items which are the subject of the requisition have been delivered to the Utility System (except with respect to requisitions for advance deposits permitted under Section 13.4(c)(iii)), free and clear of all Encumbrances, and no unsatisfied or unbonded mechanic's liens or other Encumbrances have been claimed, except for any mechanic's lien for claims that will be discharged, by bonding or otherwise, with funds to be received pursuant to such requisition (provided that a release of such lien is delivered to the Depository in accordance with Section 13.4(c)(ii)), or insured over by title insurance reasonably acceptable to UMLLC, (B) the sum then requested to be withdrawn either has been paid by the Concessionaire or is due and payable to Contractors, engineers, architects or other Persons (whose names and addresses shall be stated), who have rendered or furnished services or materials for the work and giving a brief description of such services and

materials and the principal subdivisions or categories thereof and the several amounts so paid or due to each of such Persons in respect thereof, and stating in reasonable detail the progress of the work up to the date of such certificate, (C) no part of such expenditures has been made the basis, in any previous requisition (whether paid or pending), for the withdrawal of Restoration Funds or has been made out of the Restoration Funds received by the Concessionaire, (D) the sum then requested does not exceed the value of the services and materials described in the certificate, (E) the work relating to such requisition has been performed in accordance with this Agreement, (F) the balance of the Restoration Funds held by the Depository will be sufficient upon completion of the Restoration to pay for the same in full, and stating in reasonable detail an estimate of the cost of such completion and (G) in the case of the final payment to the Concessionaire, the Restoration has been completed in accordance with this Agreement.

- (e) *Payment and Performance Bonds.* If the Concessionaire obtains payment or performance bonds related to a Restoration (which the Concessionaire may or may not obtain in its discretion), the Concessionaire shall name the State of Louisiana, UMLLC, their agents, officials, and employees, the Concessionaire and the Leasehold Mortgagee, as their interests may appear as additional obligees, and shall deliver copies of any such bonds to UMLLC promptly upon obtaining them. The claims of any such additional obligee with respect to such payment of performance bonds shall rank *pari passu* in priority with the claims of all other additional obligees.
- (f) *Benefit of UMLLC.* The requirements of this Section 13.4 are for the benefit only of UMLLC, and no Contractor or other Person shall have or acquire any claim against UMLLC as a result of any failure of UMLLC actually to undertake or complete any Restoration as provided in this Section 13.4 or to obtain the evidence, certifications and other documentation provided for herein.
- (g) *Investment of Restoration Funds.* Restoration Funds deposited with a Depository shall be invested and reinvested in Eligible Investments at the direction of the Concessionaire, and all interest earned on such investments shall be added to the Restoration Funds.
- (h) *Lien of Leasehold Mortgage.* Any Restoration Funds not used for the Restoration shall be subject to the lien of the applicable Leasehold Mortgage, but only after such Restoration is complete.
- (i) *Personal Property.* The Concessionaire shall be responsible for all loss or damage to personal property (including materials, fixtures/contents, equipment, tools and supplies) of the Concessionaire unless caused by UMLLC.

Section 13.5. Additional UMLLC Requirements.

- (a) The Concessionaire shall submit, at the Concessionaire's cost and expense, all design documents for proposed Capital Improvements to the Utility System to the standard UMLLC design and construction review process, including, but not limited to submitting documents to the University's Facilities and Property Oversight Department, c/o the Associate Vice President, Facility & Property Oversight, and UMLLC's property insurance carrier for a plan review.
- (b) The Concessionaire shall cooperate and participate, at the Concessionaire's cost and expense, in any and all Utility System Land visits or site inspections by or for any UMLLC insurance carrier.

ARTICLE 14 ADVERSE ACTIONS

Section 14.1. Adverse Action.

- (a) An "Adverse Action" shall occur if the City-Parish, the State of Louisiana, or any agency, political division, or unit or commission thereof, the University, or UMLLC, at any time during the Term, takes any action or actions and the effect of such action or actions, individually or in the aggregate, is reasonably expected (x) to be principally borne by the Concessionaire or by private sector utility concessionaires at universities and other public institutions in Louisiana, including the Concessionaire, and, in either case, not by other Persons and (y) to have a material adverse effect on the fair market value of the Concessionaire Interest (whether as a result of a decrease in the Utility Fee or other revenues, increased expenses that cannot be recovered pursuant to this Agreement, or both), except where such action is in response to any act or omission on the part of the Concessionaire that is illegal (other than an act or omission rendered illegal by virtue of the Adverse Action) or such action is otherwise permitted under this Agreement; *provided, however*, that none of the following shall be an Adverse Action: (A) the development, redevelopment, construction, modification, or change in the operation of any existing or new utility facility (other than any Utility Facility) or utility (including a new source of energy or power) (other than the Utilities) whether or not it results in the reduction of the Variable Fee Component over time; (B) the imposition of a state or local Tax of general application or federal Tax or an increase in state or local Taxes of general application or federal Taxes; or (C) any action of the Louisiana Public Service Commission or the Federal Energy Regulatory Commission, or their respective successors, that subjects the Concessionaire to such agency's regulatory jurisdiction due solely to the Utility System Operations performed by the Concessionaire in accordance with this Agreement.
- (b) If an Adverse Action occurs, the Concessionaire may elect, subject to Section 14.2 and Section 14.3, to either (i) be paid by UMLLC the Concession Compensation with respect thereto (such Concession Compensation, the "AA-Compensation") or (ii) terminate this Agreement and be paid by UMLLC the Termination Damages, in either case by giving notice in the manner described in Section 14.1(c).

- (c) If an Adverse Action occurs, the Concessionaire shall give written notice (the “AA-Preliminary Notice”) to UMLLC within thirty (30) Days following the date on which the Concessionaire first became aware of the Adverse Action stating that an Adverse Action has occurred. Within one hundred eighty (180) Days following the date of delivery of the AA-Preliminary Notice, the Concessionaire shall give UMLLC another notice (the “AA-Notice”) setting forth (i) the details of the effect of the occurrence that is principally borne by the Concessionaire, (ii) details of the material adverse effect of the said occurrence on the fair market value of the Concessionaire Interest, (iii) a statement as to which right in Section 14.1(b) the Concessionaire elects to exercise, and (iv) if the Concessionaire elects to exercise the right to AA-Compensation under Section 14.1(b), the amount claimed as AA-Compensation and details of the calculation thereof. UMLLC shall, after receipt of the AA-Notice, be entitled by notice delivered to the Concessionaire no later than thirty (30) Days following the date of receipt of the AA-Notice, to require the Concessionaire to provide such further supporting particulars as UMLLC may reasonably consider necessary. If UMLLC wishes to dispute the occurrence of an Adverse Action or the amount of AA-Compensation, if any, claimed in the AA-Notice, UMLLC shall give written notice of dispute (the “AA-Dispute Notice”) to the Concessionaire within thirty (30) Days following the date of receipt of the AA-Notice stating in reasonable detail the grounds for such dispute. If neither the AA-Notice nor the AA-Dispute Notice has been withdrawn within thirty (30) Days following the date of receipt of the AA-Dispute Notice by the Concessionaire, the matter shall be submitted to the dispute resolution procedure in Article 18.
- (d) If the Concessionaire has elected to exercise its right to AA-Compensation pursuant to Section 14.1(b), UMLLC shall pay such AA-Compensation as Concession Compensation in accordance with Article 15.
- (e) Payment of the entire sum of the Termination Damages or the AA-Compensation, as the case may be, by UMLLC to the Concessionaire, shall constitute full and final satisfaction of all amounts that may be claimed by the Concessionaire for and in respect of the occurrence of an Adverse Action, as the case may be, and, upon such payment, UMLLC shall be released and forever discharged by the Concessionaire from any and all liability in respect of such Adverse Action, except if the Concessionaire elects to be paid AA-Compensation and the effect of the applicable Adverse Action continues to be borne after the Compensation Calculation Measuring Period in which it took place, in which case, the Concessionaire may make a claim for AA-Compensation in subsequent Compensation Calculation Measuring Periods to the extent the Concessionaire is affected by such Adverse Action in such Compensation Calculation Measuring Period, but the Concessionaire may not change its election to receive AA-Compensation with respect to such Adverse Action.

Section 14.2. Termination.

- (a) If the Concessionaire has elected to exercise its right to terminate this Agreement in connection with an Adverse Action pursuant to Section 14.1(b), then this

Agreement, subject to Section 14.3, shall terminate sixty (60) Days following the date of receipt of the AA-Notice by UMLLC, and UMLLC shall pay an amount equal to the aggregate of (i) the Utility System Concession Value as of the date of such termination (which shall be determined as if no Adverse Action has occurred, plus) (ii) without duplication, the unpaid Concession and KPI Compensation Balance (for the avoidance of doubt, including any Unrecovered Balances), plus (iii) without duplication, the out-of-pocket and documented costs and expenses incurred by the Concessionaire (which costs and expenses shall include reasonable payments due and payable by the Concessionaire to the Operator or other Contractors pursuant to an Operating Agreement or similar agreement) or the Operator as a result of such termination, plus (iv) the Concession Compensation calculated for the period between the date of the Adverse Action and the date of termination less (v) any insurance or condemnation proceeds received by the Concessionaire in respect of all or any portion of the Utility System as a result of such Adverse Action (collectively, the “Termination Damages”), together with any Taxes payable by the Concessionaire on the gross amount of such Termination Damages, to the Concessionaire on the Reversion Date or, if the Termination Damages are determined on a date subsequent to the Reversion Date, then not later than sixty (60) Days following the date of determination of the Termination Damages; *provided* that, subject to the right of the Concessionaire to receive interest at the Bank Rate on the payment owed by UMLLC from the date of receipt of the AA-Dispute Notice to the date on which payment is made, UMLLC may defer any such payment for an additional one hundred twenty (120) Days in UMLLC’s discretion; *provided, however*, that any amounts received by the Concessionaire or any Leasehold Mortgagee from any insurance policies payable as a result of damage or destruction to the Utility System that has not been remedied prior to the Reversion Date, shall, to the extent not used to remedy such effects, be deducted from the amount payable by UMLLC to the Concessionaire, so long as UMLLC has not received any such amounts pursuant to Section 13.4.

- (b) Any dispute arising out of the determination of the Termination Damages shall be submitted to the dispute resolution procedure in Article 18.
- (c) This Agreement shall not terminate pursuant to Section 14.2(a) unless the Concessionaire has first obtained and delivered to UMLLC the written consent of the Leasehold Mortgagee to such termination.

Section 14.3. Right of UMLLC to Remedy. If UMLLC wishes to remedy the occurrence of an Adverse Action (other than an Adverse Action by UMLLC that constitutes a breach of this Agreement, to which this Section 14.3 shall have no application without the written consent of the Concessionaire), including by reimbursing the Concessionaire such funds as are necessary to compensate the Concessionaire for the material adverse economic effect on the Concessionaire of such Adverse Action, UMLLC shall give written notice thereof to the Concessionaire within thirty (30) Days following the date of receipt of the AA-Notice. If UMLLC gives such notice it must remedy the applicable Adverse Action within one hundred twenty (120) Days following the date of receipt of the AA-Notice or, if a AA-Dispute Notice has been given, within one hundred twenty (120) Days following the final determination pursuant to Article 18

that an Adverse Action occurred; *provided, however*, that in the event of a remedy involving payment of funds to the Concessionaire, UMLLC shall be deemed to have remedied the applicable Adverse Action as of the date that UMLLC provides a written commitment to the Concessionaire to pay such funds from time to time as are necessary to compensate the Concessionaire as it is financially adversely affected by the applicable Adverse Action from time to time. If UMLLC elects to remedy the occurrence of an Adverse Action within the applicable period of time, the right of the Concessionaire shall be limited to a claim for AA-Compensation with respect to such Adverse Action.

Section 14.4. Other Actions by Governmental Authorities. In the event that any Governmental Authority proposes to take any action at any time during the Term (including enacting any Law) and the effect of such action is reasonably expected (i) to be principally borne by the Concessionaire or by private sector utility concessionaires at universities and other public institutions in Louisiana, including the Concessionaire (and not by others) and (ii) to have a Material Adverse Effect, except where such action is in response to any act or omission on the part of the Concessionaire that is illegal (other than an act or omission rendered illegal by virtue of an Adverse Action or such action by any such Governmental Authority), then at the request of the Concessionaire, UMLLC shall use its reasonable efforts to oppose and challenge such action by any such Governmental Authority; *provided, however*, that all reasonable out-of-pocket costs and expenses incurred by UMLLC in connection with such opposition or challenge shall be borne by the Concessionaire.

Section 14.5. Regulatory Filings. The Parties acknowledge and agree that they share a common interest in any regulatory proceedings that involve the Utility System Operations. Consistent therewith, the Parties agree that, to the extent that the Concessionaire or UMLLC is required to make any regulatory filing or submission with respect to a tariff or rate for the Utility System or the Utility Fee, the Concessionaire and UMLLC shall reasonably cooperate in connection with such required filing or submission and shall, collectively, only make one filing or submission with the applicable regulatory agency. Such cooperation shall include appearing at, and participating in, any regulatory proceeding at the request of the other Party. The Concessionaire and UMLLC shall also reasonably cooperate with respect to any required regulatory filings or submissions not involving a tariff or rate for the Utility System or the Utility Fee, to the extent practicable.

ARTICLE 15

DELAY EVENTS; CONCESSION COMPENSATION AND KPI COMPENSATION

Section 15.1. Delay Events.

- (a) If the Concessionaire is affected by a Delay Event, it shall give written notice as soon as practicable but in no event later than ten (10) Business Days following the date on which it first became aware of the effect of such Delay Event on the Concessionaire (provided that in the case of such Delay Event being a continuing cause of delay, only one notice shall be necessary), which notice shall include (i) a statement of which Delay Event the claim is based upon, (ii) details of the circumstances from which the delay arises, and (iii) an estimate of the delay in the performance of obligations under this Agreement attributable to such Delay Event

and information in support thereof, if known at that time. UMLLC shall, after receipt of any such notice, be entitled by notice to require the Concessionaire to provide such further supporting particulars as UMLLC may reasonably consider necessary.

- (b) The Concessionaire shall notify UMLLC within five (5) Business Days following the date on which it first became aware that a Delay Event has ceased.
- (c) Subject to the Concessionaire giving the notice required in Section 15.1(a), a Delay Event shall excuse the Concessionaire from whatever performance is prevented by the Delay Event referred to in such notice and, to the extent applicable, for such appropriate number of Days as UMLLC and the Concessionaire jointly determine, each acting reasonably. If UMLLC and the Concessionaire cannot agree upon the period of extension, then either Party shall be entitled to refer the matter to the dispute resolution procedure in Article 18. This Section 15.1(c) shall not excuse the Concessionaire from the performance and observance under this Agreement of all obligations and covenants not affected by the Delay Event. While a Delay Event is occurring, the Utility Fee shall be reduced by an amount equal to the Utility Fee multiplied by the percentage of the Utility System that is inoperable as a result of the Delay Event, as determined by UMLLC in its reasonable discretion (as determined by the reduction in delivery capacity as compared to the delivery capacity immediately preceding such Delay Event), provided that such Delay Event shall be deemed a Compensation Event. Notwithstanding the occurrence of a Delay Event, the Concessionaire shall continue its performance and observance under this Agreement of all of its obligations and covenants to the extent that it is reasonably able to do so and shall use its commercially reasonable efforts to minimize the effect and duration of the Delay Event. Nothing herein shall permit or excuse noncompliance with a change to applicable Laws.
- (d) Except as provided in the immediately following sentence, (i) if a Delay Event occurs that has the effect of causing physical damage or destruction to a material part of the Utility System that results in the Utility System being substantially unavailable to the Concessionaire or the Operator for the performance of obligations under this Agreement and such effect continues for a period in excess of one hundred twenty (120) continuous Days or one hundred twenty (120) non-continuous Days within a three hundred sixty (360) -Day period and has a Material Adverse Effect, for which the Concessionaire is not made whole through Concession Compensation, or (ii) if insurance policies payable (or that should have been payable but for the breach of an obligation to take out and maintain such insurance policy by the Concessionaire), condemnation or other similar proceeds are insufficient to restore the Concessionaire to the same economic position as it would have been in the absence of such event and the Concessionaire is not otherwise made whole through Concession Compensation, then, notwithstanding Section 2.1, in either case, the Concessionaire shall have the right, but not the obligation, by written notice to UMLLC within thirty (30) Days after the Delay Event Remedy is permitted to be elected, to extend the Term for a period that would be sufficient to compensate the Concessionaire and restore it to the same economic

position as it would have been in had such Delay Event not occurred (a “Delay Event Remedy”); *provided, however*, in no event shall the Term be extended if such extension is prohibited by Law or if the extended Term, when taking into account such extension, would subject the Concessionaire or UMLLC to a leasehold tax, conveyance fee or similar charge under applicable Law. If the Concessionaire timely elects to exercise the right to the Delay Event Remedy but such exercise is prohibited by Law or would subject the Concessionaire or UMLLC to a leasehold tax, conveyance fee or similar charge under applicable Law, (i) the Delay Event Remedy shall be modified such that the Term is extended only for such period as would not cause exercise of the Delay Event Remedy to be prohibited by Law or to subject the Concessionaire or UMLLC to a leasehold tax, conveyance fee or similar charge under applicable Law, and (ii) the relevant Delay Event shall be a Compensation Event to the extent necessary to compensate the Concessionaire and restore it to the same economic position as it would have been in, absent the modification to the Delay Event Remedy pursuant to clause (i) of this sentence.

- (e) If the Concessionaire elects to exercise the right to the Delay Event Remedy, within five (5) Business Days following the date on which the Concessionaire first became aware of its right to the Delay Event Remedy pursuant to Section 15.1(d)(i) or Section 15.1(d)(ii), the Concessionaire shall give written notice (a “Delay Event Remedy Notice”) to UMLLC setting forth (i) the details of the relevant Delay Event and its effect on either causing physical damage or destruction to the Utility System that results in the Utility System being substantially unavailable for the provision of Utility Services, (ii) the amount claimed to be required to restore the Concessionaire to the same economic position as it would have been in had such Delay Event not occurred (including the details of the calculation thereof), and (iii) the details of the relationship between such amount and the Concessionaire’s proposed extension of the Term. UMLLC shall, after receipt of the Delay Event Remedy Notice, be entitled by notice to require the Concessionaire to provide such further supporting particulars as UMLLC may reasonably consider necessary. If UMLLC wishes to dispute the occurrence of a Delay Event or the Delay Event Remedy claimed in the Delay Event Remedy Notice, UMLLC shall give written notice to dispute (the “Delay Event Remedy Dispute Notice”) to the Concessionaire within thirty (30) Days following the date of receipt of the Delay Event Remedy Notice stating the grounds for such dispute, and if neither the Delay Event Remedy Notice nor the Delay Event Remedy Dispute Notice has been withdrawn within thirty (30) Days following the date of receipt of the Delay Event Remedy Dispute Notice by the Concessionaire, the matter shall be submitted to the dispute resolution procedure in Article 18. For the avoidance of doubt, if the conditions set forth in Section 15.1(d)(i) and Section 15.1(d)(ii) occur with respect to the same Delay Event, the Concessionaire may have two (2) opportunities to provide a Delay Event Remedy Notice.

Section 15.2. Notice of Compensation Events and KPI Events. Except as provided elsewhere in this Agreement, if a Compensation Event occurs, the Concessionaire shall give written notice to UMLLC within forty-five (45) Days following the date on which the Concessionaire first became aware of the Compensation Event stating that a Compensation Event

has occurred. Except as provided elsewhere in this Agreement, if a KPI Event occurs, UMLLC shall give written notice to the Concessionaire within forty-five (45) Days following the date on which UMLLC first became aware of the KPI Event stating that a KPI Event has occurred.

Section 15.3. Payments of Concession Compensation and KPI Compensation.

- (a) Within fourteen (14) Days after each Compensation Calculation Date, the Concessionaire shall send UMLLC notice setting forth all Concession Compensation due for the immediately preceding Compensation Calculation Measuring Period, and UMLLC shall send the Concessionaire notice setting forth all KPI Compensation due for the immediately preceding Compensation Calculation Measuring Period. Each such notice shall set forth: (i) the amount claimed and details of the calculation thereof; (ii) details of the Compensation Event(s), Adverse Action(s), and KPI Event(s), as applicable, as a result of which Concession Compensation and KPI Compensation, as applicable, is claimed therein, including an explanation of the reasons that such event(s) constitute Compensation Event(s), Adverse Action(s) and KPI Event(s), as applicable, under the terms of this Agreement; and (iii) the amount claimed as Concession Compensation and KPI Compensation, as applicable, with respect to each such Compensation Event, Adverse Action and KPI Event, as applicable, and details of the calculation thereof.
- (b) If either Party wishes to dispute the occurrence of any Compensation Event(s), Adverse Action(s), or KPI Event(s) set forth in the notices described in Section 15.3(a) or the amounts claimed thereunder, then such Party shall give written notice of dispute (the “Dispute Notice”) to the other Party within thirty (30) Days following the date of receipt of the relevant notice stating the grounds for such dispute. If the Dispute Notice has not been withdrawn or the dispute otherwise resolved by the Parties within thirty (30) Days following the date of receipt of the Dispute Notice, the matter shall be submitted to the dispute resolution procedure set forth in Article 18.
- (c) UMLLC and the Concessionaire shall cooperate and assist in good faith in the determination of the Concession Compensation and KPI Compensation in accordance with this Section 15.3, including making available, to the extent reasonably necessary, books, records, work papers and personnel at such reasonable times as any Party shall request and permitting (at the expense of the requesting Party) the copying of any records or extracts thereof reasonably requested, subject to Section 3.12.
- (d) UMLLC shall have the right, prior to any payment of the Concession and KPI Compensation Balance, to include any Concession Compensation in the applicable Utility Fee as (i) a New Approved Capital Improvement if the Concession Compensation was incurred in connection with the construction of a Capital Improvement or (ii) an Uncapped O&M Cost payable over the next Fiscal Year in equal monthly installments.

- (e) Following the final determination of the Concession Compensation and KPI Compensation, (i) if the Concession and KPI Compensation Balance is positive, then UMLLC shall pay, within ninety (90) Days of such final determination, to the Concessionaire, the Concession and KPI Compensation Balance or add such amount to the immediately succeeding payment of the Utility Fee in accordance with Section 15.3(d), if applicable or (ii) if the Concession and KPI Compensation Balance is negative, then the Concessionaire shall pay, within ninety (90) Days of such final determination, to UMLLC, the absolute amount of the Concession and KPI Compensation Balance or, with UMLLC's consent, offset such amount against the immediately succeeding payment of the Utility Fee, if applicable.
- (f) For the determination of the Concession and KPI Compensation Balance for the Compensation Calculation Date that is the End Date, the Concession Compensation shall also include all Unrecovered Balances as of the End Date, unless this Agreement is terminated as a result of a Concessionaire Default, in which case no Unrecovered Balances shall be included in the Concession and KPI Compensation Balance.

Section 15.4. KPI Compensation. Other than UMLLC's right to cause the Concessionaire to remove the Operator pursuant to Section 3.3(c), the payment of KPI Compensation by the Concessionaire shall constitute the Concessionaire's sole and exclusive liability and UMLLC's sole and exclusive remedy for any KPI Event.

Section 15.5. Maximum Annual Amount of KPI Compensation. Notwithstanding anything to the contrary contained herein, the maximum amount of KPI Compensation for which the Concessionaire may be liable in any given Fiscal Year shall be the greater of (a) ten percent (10%) of the Utility Fee otherwise payable during such Fiscal Year, or (b) two million five hundred thousand dollars (\$2,500,000); *provided that* any KPI Compensation in excess of such cap in any Fiscal Year for which the Concessionaire would otherwise be liable shall become due and owing in the subsequent Fiscal Year (but subject to the same cap in such Fiscal Year) until the earlier of (x) the second (2nd) anniversary of the Fiscal Year in which the KPI Compensation was incurred and (y) the time that all such outstanding amounts are paid to UMLLC pursuant to this Section 15.5, and such deferred amounts shall accrue interest at a rate equal to the lesser of (A) the sum of the Bank Rate plus three percent (3%) per annum and (B) the maximum interest rate permitted by Law. For the avoidance of doubt, the limitation on the maximum amount of KPI Compensation shall not limit the number of KPI Events that have occurred, including the determination of the number of KPI Events in a Fiscal Year for purposes of Section 3.3 or the determination of future KPI Compensation.

ARTICLE 16 DEFAULTS

Section 16.1. Default by the Concessionaire.

- (a) *Events of Default.* The occurrence of any one or more of the following events during the Term shall constitute a "Concessionaire Default" under this Agreement:

- (i) the Concessionaire fails to comply with, perform or observe any material obligation, covenant, agreement, term, or condition in this Agreement (other than a breach of the Performance Standards, a KPI Event, or a breach of Section 21.1(a)), and such failure continues unremedied for a period of ninety (90) Days following notice thereof (giving particulars of the failure in reasonable detail) from UMLLC to the Concessionaire or for such longer period as may be reasonably necessary to cure such failure, provided, in the latter case, that the Concessionaire has demonstrated to the satisfaction of UMLLC, that (A) it is proceeding, and will proceed, with all due diligence to cure or cause to be cured such failure, (B) its actions can be reasonably expected to cure or cause to be cured such failure within a reasonable period of time acceptable to UMLLC, and (C) such failure is, in fact, cured within such period of time;
- (ii) the Concessionaire fails to remedy any Transfer of this Agreement or all or any portion of the Concessionaire Interest in contravention of Article 17 within ten (10) Business Days following notice thereof from UMLLC to the Concessionaire;
- (iii) the Concessionaire fails to comply with the requirements or directives of a final award in a matter submitted to dispute resolution in accordance with Article 18, and such failure continues unremedied for a period of [fifty (50)] Days following notice thereof from UMLLC to the Concessionaire, or for such longer period as may be reasonably necessary to cure such failure, provided, in the latter case, that the Concessionaire has demonstrated to the satisfaction of UMLLC, that (A) it is proceeding, and will proceed, with all due diligence to cure or cause to be cured such failure, (B) its actions can be reasonably expected to cure or cause to be cured such failure within a reasonable period of time acceptable to UMLLC, and (C) such failure is, in fact, cured within such period of time;
- (iv) the Concessionaire (A) admits, in writing, that it is unable to pay its debts as such become due, (B) makes an assignment for the benefit of creditors, (C) files a voluntary petition under Title 11 of the United States Code, or such petition is filed against it and an order for relief is entered, or the Concessionaire files any petition or answer seeking, consenting to or acquiescing in any reorganization, arrangement, composition, readjustment, liquidation, dissolution, or similar relief under the present or any future United States Bankruptcy Code or any other present or future applicable Law, or shall seek or consent to or acquiesce in or suffer the appointment of any trustee, receiver, custodian, assignee, sequestrator, liquidator, or other similar official of the Concessionaire or of all or any substantial part of its properties or of the Utility System or any interest therein, or (D) takes any corporate action in furtherance of any action described in this Section 16.1(a)(iv);

- (v) within ninety (90) Days after the commencement of any proceeding against the Concessionaire seeking any reorganization, arrangement, composition, readjustment, liquidation, dissolution, or similar relief under the present or any future United States Bankruptcy Code or any other present or future applicable Law, such proceeding has not been dismissed, or, within ninety (90) Days after the appointment, without the consent or acquiescence of the Concessionaire, of any trustee, receiver, custodian, assignee, sequestrator, liquidator or other similar official of the Concessionaire or of all or any substantial part of its properties or of the Utility System or any interest therein, such appointment has not been vacated or stayed on appeal or otherwise, or, within ninety (90) Days after the expiration of any such stay, such appointment has not been vacated;
 - (vi) a levy under execution or attachment has been made against all or any part of the Utility System or any interest therein as a result of any Encumbrance (other than a Permitted Concessionaire Encumbrance) created, incurred, assumed, or suffered to exist by the Concessionaire or any Person claiming through it, and such execution or attachment has not been vacated, removed or stayed by court order, bonding or otherwise within sixty (60) Days after the Concessionaire becomes aware of such levy, unless such levy resulted from actions or omissions of UMLLC or its Representatives;
 - (vii) the Concessionaire Abandons the Initial Modernization Project or otherwise repudiates in writing any of its material obligations under this Agreement;
 - (viii) the Concessionaire fails to achieve IMP Substantial Completion by the IMP Substantial Completion Long Stop Date, or the Concessionaire fails to achieve IMP Final Acceptance by the IMP Final Acceptance Long Stop Date, and in either case, such failure continues unremedied for a period of thirty (30) Days following notice thereof (giving particulars of the failure in reasonable detail) from UMLLC to the Concessionaire; or
 - (ix) the Concessionaire fails to obtain, provide, or maintain the D&C Security in accordance with the terms of this Agreement and such failure continues unremedied for a period of thirty (30) Days following notice thereof from UMLLC to the Concessionaire.
- (b) *Remedies of UMLLC upon Concessionaire Default.* Upon the occurrence, and during the continuance, of a Concessionaire Default, UMLLC may, by notice to the Concessionaire, declare the Concessionaire to be in default and may, subject to the provisions of Article 18 and Article 19, do any or all of the following as UMLLC, in its discretion, shall determine:
- (i) subject to the cure rights of the Leasehold Mortgagee set forth in Section 19.3, UMLLC may terminate this Agreement by giving fifty (50) Days' prior notice to the Concessionaire upon the occurrence of any Concessionaire Default; *provided, however*, that the Concessionaire shall

be entitled to cure a Concessionaire Default pursuant to Section 16.1(a)(i) or Section 16.1(a)(viii) by (i) agreeing within such fifty (50) -Day period to pay any Losses sustained as a result of such Concessionaire Default and (ii) providing UMLLC with a written work plan within such fifty (50) -Day period outlining the actions by which the Concessionaire will ensure future compliance with either (x) the obligation, covenant, agreement, term or condition in this Agreement or (y) the requirements or directives of the issued final award in accordance with Article 18 that the Concessionaire failed to perform or observe, which work plan is Approved by UMLLC, but any failure of the Concessionaire to comply in any material respect with such Approved work plan (other than as a result of a Delay Event) following thirty (30) Days' notice of such failure from UMLLC to the Concessionaire shall be deemed to be a Concessionaire Default described in Section 16.1(a)(i) or Section 16.1(a)(viii), as applicable, and the entitlement of the Concessionaire to cure such Concessionaire Default by the delivery of an Approved work plan shall not apply thereto;

- (ii) if the Concessionaire Default is by reason of the failure to pay any monies to another Person, UMLLC may (without obligation to do so) make payment on behalf of the Concessionaire of such monies unless such non-payment is due to a bona fide dispute, and any amount so paid by UMLLC shall be payable by the Concessionaire to UMLLC within three (3) Business Days after demand therefor;
- (iii) subject to the cure rights of the Leasehold Mortgagee set forth in Section 19.3, UMLLC may cure the Concessionaire Default (but this shall not obligate UMLLC to cure or attempt to cure a Concessionaire Default or, after having commenced to cure or attempted to cure a Concessionaire Default, to continue to do so), and all costs and expenses reasonably incurred by UMLLC in curing or attempting to cure the Concessionaire Default, shall be payable by the Concessionaire to UMLLC within three (3) Business Days after written demand therefor; *provided, however*, that: (A) UMLLC shall not incur any liability to the Concessionaire for any act or omission of UMLLC or any other Person in the course of remedying or attempting to remedy any Concessionaire Default unless resulting from UMLLC's recklessness, gross negligence or willful misconduct; (B) UMLLC's cure of any Concessionaire Default shall not affect UMLLC's rights against the Concessionaire by reason of the Concessionaire Default; and (C) UMLLC may seek specific performance, injunction, or other equitable remedies, it being acknowledged that damages are an inadequate remedy for a Concessionaire Default;
- (iv) UMLLC may seek to recover its Losses arising from such Concessionaire Default and any amounts due and payable under this Agreement and, in connection therewith, exercise any recourse available to any Person who is owed damages or a debt;

- (v) with respect to those Concessionaire Defaults that entitle UMLLC to terminate this Agreement pursuant to Section 16.1(b)(i), UMLLC may terminate the Concessionaire's right to use, operate, maintain, possess, control, and rehabilitate the Utility System and the Concessionaire's right to collect from UMLLC and retain the Utility Fee, and in such event, UMLLC or UMLLC's agents and servants may immediately or at any time thereafter take possession and control of the Utility System, by any available action under Law or proceeding at law or in equity, and with or without terminating this Agreement, and undertake any and all of the Utility System Operations; *provided, however*, that no such action by UMLLC shall be construed as an election on its part to terminate this Agreement unless a notice of such intention is given to the Concessionaire; and
- (vi) UMLLC may exercise any of its other rights and remedies provided for hereunder or at law or equity.

Section 16.2. Default by UMLLC.

- (a) *Events of Default.* The occurrence of any one or more of the following events during the Term shall constitute a "UMLLC Default" under this Agreement:
 - (i) UMLLC fails to pay the Utility Fee, the Forecast Utility Fee or the Concession and KPI Compensation Balance to the extent UMLLC is required to do so pursuant to Section 15.3(f), each in accordance herewith and such failure continues unremedied for a period of five (5) Business Days following notice thereof (giving particulars of the failure in reasonable detail) from the Concessionaire to UMLLC;
 - (ii) UMLLC fails to comply with or observe any material obligation, covenant, agreement, term, or condition in this Agreement (other than an Adverse Action or the payment of the Utility Fee, the Forecast Utility Fee or the Concession and KPI Compensation Balance to the extent UMLLC is required to do so pursuant to Section 15.3(f)) and such failure continues unremedied for a period of ninety (90) Days following notice thereof (giving particulars of the failure in reasonable detail) from the Concessionaire to UMLLC or for such longer period as may be reasonably necessary to cure such failure, provided, in the latter case, that UMLLC has demonstrated to the satisfaction of the Concessionaire, that (A) it is proceeding with all due diligence to cure or cause to be cured such failure, (B) its actions can be reasonably expected to cure or cause to be cured such failure within a reasonable period of time acceptable to the Concessionaire, and (C) such failure is, in fact, cured within such period of time;
 - (iii) UMLLC fails to comply with the requirements or directives of a final award in a matter submitted to dispute resolution in accordance with Article 18 and such default continues unremedied for a period of fifty (50) Days following notice thereof from the Concessionaire to UMLLC, or for such

longer period as may be reasonably necessary to cure such failure, provided, in the latter case, that UMLLC has demonstrated to the satisfaction of the Concessionaire, acting reasonably, that (A) it is proceeding, and will proceed, with all due diligence to cure or cause to be cured such failure, (B) its actions can be reasonably expected to cure or cause to be cured such failure within a reasonable period of time acceptable to the Concessionaire, acting reasonably and (C) such failure is, in fact, cured within such period of time;

- (iv) a levy under execution or attachment has been made against all or any part of the Utility System or the Concessionaire Interest as a result of any Encumbrance (other than a Permitted UMLLC Encumbrance) created, incurred, assumed or suffered to exist by UMLLC or any Person claiming through it, and such execution or attachment has not been vacated, removed or stayed by court order, bonding or otherwise within a period of sixty (60) Days, unless such levy resulted from actions or omissions of the Concessionaire or its Representatives or all or a material part of the Utility System shall be subject to a condemnation or similar taking by UMLLC or any agency thereof;
- (v) UMLLC (A) admits, in writing, that it is unable to pay its debts as such become due, (B) makes an assignment for the benefit of creditors, (C) files a voluntary petition under Title 9 of the United States Code, or such petition is filed against it and an order for relief is entered, or UMLLC files any petition or answer seeking, consenting to or acquiescing in any reorganization, arrangement, composition, readjustment, liquidation, dissolution, or similar relief under the present or any future United States Bankruptcy Code or any other present or future applicable Law, or shall seek or consent to or acquiesce in or suffer the appointment of any trustee, receiver, custodian, assignee, sequestrator, liquidator, or other similar official of UMLLC, or of all or any substantial part of its properties (in each case, to the extent applicable to a municipality), or (D) takes any action in furtherance of any action described in this Section 16.2(a)(v); or within ninety (90) Days after the commencement of any proceeding against UMLLC seeking any reorganization, arrangement, composition, readjustment, liquidation, dissolution, or similar relief under the present or any future United States Bankruptcy Code or any other present or future applicable Law, such proceeding has not been dismissed, or, within ninety (90) Days after the appointment, without the consent or acquiescence of UMLLC, of any trustee, receiver, custodian, assignee, sequestrator, liquidator, or other similar official of UMLLC or of all or any substantial part of its properties (in each case, to the extent applicable to a municipality), such appointment has not been vacated or stayed on appeal or otherwise, or, within ninety (90) Days after the expiration of any such stay, such appointment has not been vacated; or

- (vi) UMLLC repudiates in writing any of its material obligations under this Agreement.

- (b) *Remedies of Concessionaire Upon UMLLC Default.* Upon the occurrence, and during the continuance, of a UMLLC Default, the Concessionaire may by notice to UMLLC declare UMLLC to be in default and may, subject to the provisions of Article 18, do any or all of the following as the Concessionaire, in its discretion, shall determine:
 - (i) terminate this Agreement by giving ninety (90) Days' prior notice to UMLLC; *provided, however*, that UMLLC shall be entitled to cure a UMLLC Default pursuant to Section 16.2(a)(ii) or Section 16.2(a)(iii) by (i) agreeing within such sixty (60) -Day period to pay any Losses sustained as a result of such UMLLC Default or (ii) providing the Concessionaire with a written work plan within such sixty (60) -Day period outlining the actions by which UMLLC will ensure future compliance with either (x) the obligation, covenant, agreement, term, or condition in this Agreement that UMLLC failed to perform or observe or (y) the requirements or directives of the final award issued in accordance with Article 18 that UMLLC failed to perform or observe, which work plan is approved by the Concessionaire, but any failure of UMLLC to comply in any material respect with such approved work plan following thirty (30) Days' notice of such failure from the Concessionaire to UMLLC shall be deemed to be a UMLLC Default described in Section 16.2(a)(ii) and the entitlement of UMLLC to cure such UMLLC Default by the delivery of an approved work plan shall not apply thereto; and upon such termination, UMLLC shall be obligated to pay to the Concessionaire the Utility System Concession Value plus, without duplication, the unpaid Concession and KPI Compensation Balance (for the avoidance of doubt, including any Unrecovered Balances) and the out-of-pocket and documented costs and expenses incurred by the Concessionaire as a result of such termination together with any Taxes payable by the Concessionaire on the foregoing that exceed the Taxes the Concessionaire would have paid on future receipts of the Utility Fee if the termination of this Agreement pursuant to this Section 16.2(b)(i) had not occurred (using the Tax rates in effect when such damages would be payable);
 - (ii) exercise any of its rights or remedies at law or in equity;
 - (iii) seek to recover its Losses and any amounts due and payable under this Agreement and, in connection therewith, exercise any recourse available to any Person who is owed damages or a debt; and
 - (iv) seek specific performance, injunction or other equitable remedies, it being acknowledged that damages are an inadequate remedy for a UMLLC Default.

Section 16.3. Consequences of Termination or Reversion. Upon the termination or expiration of this Agreement, notwithstanding any claims the Parties may have against each other and subject to Section 16.2(b)(iii), the following provisions shall apply:

- (a) the Concessionaire shall, without action whatsoever being necessary on the part of UMLLC (other than any payment obligations of UMLLC with respect to such termination (including, for the avoidance of doubt, any payment obligations pursuant to Sections 14.2(a), 15.3(f) or 16.2(b)(i), if any, and the payment obligation set forth in this Section 16.3(a)), surrender, transfer and deliver to UMLLC the Utility System (including all improvements to the Utility System), the Utility System Assets and all tangible and intangible personal property of the Concessionaire (including inventories) that is included in the Utility System or used in connection with the Utility System Operations, in good order, condition and repair (reasonable wear and tear excepted), determined reasonably in accordance with the then applicable Performance Standards, free and clear of all Encumbrances other than (w) Permitted Concessionaire Encumbrances set forth in clauses (iv) and (vii) of the definition of that term, (x) Permitted UMLLC Encumbrances, (y) those created by or suffered to exist or consented to by UMLLC or any Person claiming through it, and (z) with respect to any property added to the Utility System after the Time of Turnover, title defects affecting such property in existence on the date such property is added to the Utility System, all in exchange for one dollar (\$1) paid by UMLLC on the Reversion Date;
- (b) the Concessionaire hereby waives any notice now or hereafter required by Law with respect to transfer of the Utility System on the Reversion Date;
- (c) UMLLC shall, as of the Reversion Date, assume full responsibility for the Utility System Operations, and as of such date, the Concessionaire shall have no liability or responsibility for Utility System Operations occurring after such date;
- (d) the Concessionaire shall be liable for all costs, expenses and other amounts for which it is liable or responsible hereunder incurred up to but not including the Reversion Date, and UMLLC shall be liable for all costs, expenses and amounts incurred in connection with the Utility System Operations on and after the Reversion Date;
- (e) UMLLC shall have the option, subject to the rights of any Leasehold Mortgagee, or its designee or nominee, to enter into a New Agreement with a third party, by providing notice to the Concessionaire requiring that the Concessionaire assign, without warranty or recourse to the Concessionaire, to the fullest extent permitted by Authorizations and applicable Law, all of its right, title and interest in, to and under (in each of the following cases, to the extent assignable) all or any of the Operating Agreements then in effect and all Authorizations to UMLLC or its nominee for the remainder of their respective terms; *provided, however*, that if UMLLC exercises such option, the right, title and interest of the Concessionaire in, to and under such Operating Agreements and Authorizations shall be assigned to UMLLC or its nominee as of the Reversion Date and the Concessionaire shall

surrender the Utility System to UMLLC and shall cause all Persons claiming under or through the Concessionaire to do likewise, and UMLLC shall assume in writing, pursuant to an assumption agreement satisfactory to the Concessionaire, the Concessionaire's obligations under the Operating Agreements that arise in respect of, or relate to, any period of time falling on and after the Reversion Date; *provided further*, that if UMLLC does not exercise such option, the Concessionaire shall take such steps as are necessary to terminate the Operating Agreements to the extent permitted thereunder and in accordance with the terms thereof;

- (f) the Concessionaire, at its sole cost and expense, shall promptly deliver to UMLLC copies of all records and other documents relating to the Utility Fee that are in the possession of the Concessionaire or its Representatives and all other then-existing records and information relating to the Utility System as UMLLC, acting reasonably, may request;
- (g) the Concessionaire shall execute and deliver to UMLLC transfer of title documents and other instruments reasonably required by UMLLC to evidence such termination;
- (h) the Concessionaire shall assist UMLLC in such manner as UMLLC may require to ensure the orderly transition of control, operation, management, maintenance and rehabilitation of the Utility System, and shall, if appropriate and if requested by UMLLC, take all steps as may be necessary to enforce the provisions of the Operating Agreements pertaining to the surrender of the Utility System;
- (i) UMLLC and the Concessionaire shall make appropriate adjustments, including adjustments relating to any Operating Agreements assigned to UMLLC, Utility Fee and other similar charges collected on and after the Reversion Date that are incurred prior to the Reversion Date, and utilities, and any adjustments and payment therefor shall be made by the appropriate Party on the Reversion Date, but shall be subject to readjustment if necessary because of error in matters such as information, calculation, payments and omissions that are identified within the period of one hundred eighty (180) Days following the Reversion Date; *provided, however*, that UMLLC and the Concessionaire acknowledge that certain adjustments or readjustments may have to be made when a third party provides to UMLLC or the Concessionaire a final adjustment amount in respect of a matter, and for such matters the adjustment and readjustment date shall each be correspondingly extended;
- (j) if this Agreement is terminated as a result of an Adverse Action, the payment by UMLLC to the Concessionaire of the amounts required under Article 14 or Article 18 shall constitute full and final settlement of any and all Claims the Concessionaire may have against UMLLC for and in respect of the termination of this Agreement and upon such payment, the Concessionaire shall execute and deliver all such releases and discharges as UMLLC may reasonably require to give effect to the foregoing;

- (k) all plans, drawings, specifications and models prepared in connection with construction at the Utility System and in the Concessionaire's possession and all "as-built" drawings shall become the sole and absolute property of UMLLC, and the Concessionaire shall promptly deliver to UMLLC all such plans, drawings, specifications and models and all such as-built drawings (but may keep copies of those plans, drawings, specifications and models that were developed by the Concessionaire or its Representatives); and
- (l) UMLLC and the Concessionaire shall undertake reasonable efforts to transition Concessionaire Utility System Employees to the University, UMLLC, or their designee, subject to the University's and/or UMLLC's then-applicable employment policies and legal requirements.

This Section 16.3 shall survive the expiration or any earlier termination of this Agreement.

Section 16.4. Termination Other than Pursuant to Agreement. If this Agreement (i) is terminated by UMLLC other than pursuant to Section 16.1, (ii) is canceled, rescinded or voided during the Term for any reason over the objection and without action by the Concessionaire, or (iii) terminates as provided in Section 11.15(c), then UMLLC shall (without limiting any payment obligations set forth in Section 15.3(f)) pay to the Concessionaire the Utility System Concession Value as of the date of such termination, cancellation, rescinding, or voiding, plus, without duplication, (A) unpaid Concession and KPI Compensation Balance (for the avoidance of doubt, including any Unrecovered Balances), and (B) the out-of-pocket and documented costs and expenses incurred by the Concessionaire or the Operator as a direct result of such termination, cancellation, rescinding, or voiding, and (C) any Taxes payable by the Concessionaire on the foregoing (A) through (B) that exceed the Taxes the Concessionaire would have paid on future receipts of the Utility Fee if the termination of this Agreement pursuant to this Section 16.4 had not occurred (using the Tax rates in effect when such damages would be payable). UMLLC hereby acknowledges and agrees that it may only terminate this Agreement in accordance with the express terms hereof and shall not, in any event, have the right to terminate this Agreement for convenience. The Concessionaire hereby acknowledges and agrees that it may only terminate this Agreement in accordance with the express terms hereof and shall not, in any event, have the right to terminate this Agreement for convenience or to challenge the validity or enforceability of this Agreement. For the avoidance of doubt, the termination of this Agreement as provided in Section 11.15(c) shall not constitute termination for convenience by either UMLLC or the Concessionaire.

ARTICLE 17 RESTRICTIONS ON TRANSFERS

Section 17.1. Transfers by the Concessionaire.

- (a) Subject in all respects to the collateral assignment of the Concessionaire Interest to the Leasehold Mortgagee, and exercise by the Leasehold Mortgagee of its rights pursuant to such assignment, including by foreclosure, as set forth in Article 19, the Concessionaire shall not:

- (i) Prior to the second (2nd) anniversary of the IMP Substantial Completion Date, Transfer, or otherwise permit the Transfer, of any part of the Concessionaire Interest to or in favor of a Transferee (other than a Transferee that is an Affiliate or a Leasehold Mortgagee under or nominee/designee of a Leasehold Mortgagee under Article 19);
- (ii) On or after the second (2nd) anniversary of the IMP Substantial Completion Date, Transfer, or otherwise permit the Transfer, of any part of the Concessionaire Interest to or in favor of a Transferee (other than a Transferee that is an Affiliate or a Leasehold Mortgagee under or nominee/designee of a Leasehold Mortgagee under Article 19) that would result in the Concessionaire directly owning fifty percent (50%) or less of the Concessionaire Interest granted to the Concessionaire as of the date hereof;

unless:

- (A) in the case of clause (i) of this Section 17.1(a), the UMLLC Liaison has Approved such Transfer in his or her sole discretion; and
- (B) in the case of clause (ii) of this Section 17.1(a), (x) the UMLLC Liaison has Approved (based upon a determination in accordance with Section 17.1(b)) such proposed Transferee, and the proposed Transferee (other than a Transferee that is an Affiliate or a Leasehold Mortgagee under Article 19) enters into an agreement with UMLLC in form and substance satisfactory to the UMLLC Liaison, acting reasonably, wherein the Transferee acquires the rights and assumes the obligations of the Concessionaire and agrees to perform and observe all of the obligations and covenants of the Concessionaire under this Agreement.
- (iii) Any Transfer made in violation of this Section 17.1(a) shall be null and void ab initio and of no force and effect.

In no event shall the Concessionaire permit a Transfer of the Concessionaire Interest to a Restricted Person.

- (b) Approval of a proposed Transfer pursuant to Section 17.1(a)(ii) may be withheld if the UMLLC Liaison reasonably determines that (i) such proposed Transfer is prohibited by applicable Law, (ii) such proposed Transferee's entering into this Agreement with UMLLC is prohibited by Law, (iii) such proposed Transfer would result in a violation of Law, (iv) such proposed Transfer would result in a Tax liability to UMLLC (unless UMLLC shall have received indemnification, as determined in the UMLLC Liaison's discretion, with respect thereto), or (v) such proposed Transferee is not capable of performing the obligations and covenants of the Concessionaire under this Agreement. Such determination shall be based upon and take into account the following factors, in each case assessed as of the date of such determination but after giving effect to the proposed Transfer together with any related transactions (including the proposed transfer of employees and other

resources to such Transferee in connection with such proposed Transfer and related transactions): (a) the financial strength and integrity of the proposed Transferee, its direct or indirect beneficial owners, any proposed managers or operating partners, and each of their respective Affiliates; (b) the experience of the proposed Transferee or the Operator engaged by the proposed Transferee in operating a Comparable Utility System and performing other relevant projects; (c) the background and reputation of the proposed Transferee, its direct or indirect beneficial owners, any proposed managers or operating partners, each of their respective officers, directors and employees and each of their respective Affiliates (including the absence of criminal, civil or regulatory claims or actions against any such Person and the quality of any such Person's past or present performance on other projects); and (d) the IMP Contractor or the Operator, as the case may be, engaged by the proposed Transferee, including the ability of the IMP Contractor or the Operator, as the case may be, to comply with, respectively, the Design Documents and the Performance Standards. If the Concessionaire disputes the UMLLC Liaison's determination under this Section 17.1(b), such dispute shall be resolved in accordance with Article 18.

- (c) If requested by the Concessionaire, the UMLLC Liaison shall, on a confidential basis (unless disclosure is required by applicable Law) and at the Concessionaire's sole cost and expense, evaluate one or more proposed Transferees (including as provided in Section 17.1(b), as applicable) and notify the Concessionaire within thirty (30) Business Days of its Approval or withholding of Approval with respect to such proposed Transferee(s).
- (d) No Transfer of all or any of the Concessionaire Interest (except for a Transfer to a Leasehold Mortgagee or its nominee upon its exercise of remedies under the Leasehold Mortgage and any subsequent transfer to the transferee of the Leasehold Mortgagee that has been Approved as provided in Section 17.1(a) and (as applicable) Section 17.1(b)) shall be made or have any force or effect if, at the time of such Transfer there has occurred a Concessionaire Default that has not been remedied or an event that with the lapse of time, the giving of notice or otherwise would constitute a Concessionaire Default.
- (e) Other than a Change in Control occasioned by the exercise by any Leasehold Mortgagee of its remedies under any pledge of shares, limited liability company interest or partnership interest:
 - (i) Prior to the second (2nd) anniversary of the IMP Substantial Completion Date, the Initial Investors, collectively, shall not cease to own one hundred percent (100%) of the ownership of the Concessionaire (or otherwise possess less than all of the power to direct or cause the direction of the management of the Concessionaire).
 - (ii) On or after the second (2nd) anniversary of the IMP Substantial Completion Date, a Change in Control of the Concessionaire shall be deemed to be a Transfer of the Concessionaire Interest for purposes of Section 17.1(a) (thus

requiring UMLLC's Approval) and shall be evaluated by the UMLLC Liaison (including as provided in Section 17.1(b) and Section 17.1(c), as applicable).

- (iii) Any transfer of an interest in a Person that, directly or indirectly, owns an interest in the Concessionaire to a Restricted Person shall be a violation of this Agreement, unless such transfer is made pursuant to a bona fide open market transaction on the New York Stock Exchange, NASDAQ, Toronto Stock Exchange, London Stock Exchange, or comparable U.S. or foreign securities exchange.
- (f) Nothing contained in the foregoing shall be deemed to prohibit or limit the Concessionaire from changing its name, organizational form or status (including a change from a limited liability company to a corporation or limited partnership), provided that such change in name, organizational form or status does not result in a Change in Control of the Concessionaire.

Section 17.2. Assignment by UMLLC. UMLLC shall have the right to Transfer any or all of its interest in the Utility System and this Agreement (a) without the Concessionaire's consent, to any Person that (i) is a successor to UMLLC or similarly organized under and operated for the tax-exempt purposes of the Foundation, (ii) has (A) the sources of funding available for the payment of Concession Compensation (including AA-Compensation) that are at least as adequate and secure as UMLLC's at the time of the assignment, and (B) has access to debt markets that is at least as adequate as UMLLC's at the time of the assignment, and (iii) is able to receive such assignment without causing, directly or indirectly, the Concessionaire to experience any adverse tax consequence as a result of such assignment, or (b) to others with the prior consent of the Concessionaire; *provided* that, in either of the foregoing clauses (a) or (b), UMLLC shall be jointly and severally liable with such proposed transferee for the performance and observance of the obligations and covenants of UMLLC under this Agreement, and any agreement entered into by UMLLC under this Agreement (including agreeing directly with any Leasehold Mortgagee to be bound by the agreement entered into in accordance with Section 19.3) and that any such Transfer by UMLLC shall not materially limit or reduce any of the Concessionaire's other rights, benefits, remedies, or privileges under this Agreement nor shall it materially impair UMLLC's ability to meet its obligations under this Agreement and, provided further, that any such Transfer shall be subject to the rights and Encumbrances of the Concessionaire and of the Leasehold Mortgagee under any Leasehold Mortgage. In the event that UMLLC (x) ceases to be organized and operated for the tax-exempt purposes of the Foundation or (y) no longer has access to substantially the same funding sources or debt markets as UMLLC had as of the Effective Date, then by notice from the Concessionaire to UMLLC and the University, a process by which UMLLC's rights to the Utility System and this Agreement will be Transferred to the University shall commence within thirty (30) days after the date of such notice and shall conclude with a Transfer that is otherwise in compliance with this Section 17.2 within ninety (90) days after such notice.

ARTICLE 18 DISPUTE RESOLUTION

Section 18.1. Scope. Any dispute arising out of, relating to, or in connection with this Agreement shall be resolved as set forth in this Article 18.

Section 18.2. Informal Dispute Resolution Procedures. The Parties shall attempt in good faith to resolve such dispute within fifteen (15) Business Days following receipt by one Party of notice of such dispute from the other Party. If the Parties are unable to resolve the dispute within such period of fifteen (15) Business Days, and upon notice by either Party to the other, the dispute shall be referred to the Designated Senior Person of each Party. The Designated Senior Persons shall negotiate in good faith to resolve the dispute, conferring as often as they deem reasonably necessary. Statements made by Representatives of the Parties during the dispute resolution procedures set forth in this Section 18.2 and in Section 18.3 and documents specifically prepared for such dispute resolution procedures shall be considered part of settlement negotiations and shall not be admissible as evidence in any litigation proceeding between the Parties without the mutual consent of the Parties.

Section 18.3. Mediation. Mediation of a dispute under this Agreement may not be commenced until the earlier of: (i) such time as both of the Designated Senior Persons, after following the procedures set forth in Section 18.2, conclude in good faith that amicable resolution through continued negotiation of the matter does not appear likely; or (ii) fifteen (15) Business Days after the notice referring the dispute to the Designated Senior Persons, pursuant to Section 18.2. If, after such time period, the dispute remains unresolved, the Parties shall attempt to resolve the dispute through mediation administered by the AAA under its Commercial Mediation Procedures before resorting to litigation, as provided by Section 18.4. The Parties agree that any period of limitation applicable to the assertion of a claim shall be deemed tolled during the conduct of informal dispute resolution under Section 18.2 and mediation under this Section 18.3, and that any claim of any Party shall be deemed not to have accrued until the mediation is terminated.

Section 18.4. Litigation. Unless the Parties otherwise agree, if mediation as set forth in Section 18.3 does not resolve the dispute within thirty (30) Business Days following a reference to mediation or such longer period as the Parties may mutually agree, then the Parties shall present the dispute to such court of competent jurisdiction as set forth in Section 20.7.

Section 18.5. Provisional Remedies. No Party shall be precluded from initiating a proceeding in a court of competent jurisdiction for the purpose of obtaining any emergency or provisional remedy to protect its rights that may be necessary and that is not otherwise available under this Agreement or to enforce or execute upon a judgment entered in accordance with this Agreement, including temporary, preliminary and permanent injunctive relief and restraining orders, writs of mandamus, and the appointment of a receiver or receiver and manager in connection with the collection and retention of the Utility Fee.

Section 18.6. Tolling. If a Party receiving a notice of default under this Agreement contests, disputes or challenges the propriety of such notice by making application to the dispute resolution procedure in this Article 18, any cure period that applies to such default shall be tolled for the time period between such application and the issuance of a final award or determination.

ARTICLE 19 LENDERS

Section 19.1. Leasehold Mortgages. The Concessionaire shall have the right, at its sole cost and expense, to grant one or more Leasehold Mortgages, if at the time any such Leasehold Mortgage is executed and delivered to the Leasehold Mortgagee, no Concessionaire Default exists and upon and subject to the following terms and conditions:

- (a) a Leasehold Mortgage may not cover any property of, or secure any debt issued or guaranteed by, any Person other than the Concessionaire or the Concessionaire Parent, but may cover shares or equity interests in the capital of the Concessionaire and any cash reserves or deposits held in the name of the Concessionaire;
- (b) no Person other than an Institutional Lender shall be entitled to the benefits and protections accorded to a Leasehold Mortgagee in this Agreement; *provided, however,* that lessors and lenders to the Concessionaire (and lenders to a Leasehold Mortgagee that is a Lessor) may be Persons other than Institutional Lenders so long as any Leasehold Mortgage securing the loans made by such Persons is held by an Institutional Lender acting as collateral agent or trustee;
- (c) no Leasehold Mortgage or other instrument purporting to mortgage, pledge, encumber, or create a lien, charge, or security interest on or against any or all of the Concessionaire Interest shall extend to or affect the fee simple interest in the Utility System, UMLLC's interest hereunder or UMLLC's or the University's reversionary interests and estates in and to the Utility System or any part thereof; in addition, any termination of this Agreement, following the expiration of the Leasehold Mortgagee's cure period in Section 19.3, if any, without a cure, by UMLLC shall simultaneously terminate the Leasehold Mortgage; *provided, however,* such termination of the Leasehold Mortgage and the Concessionaire's leasehold interest in the Utility System, shall not affect, modify or terminate the Concessionaire's obligations to the Leasehold Mortgagee with respect to the Leasehold Mortgage Debt;
- (d) UMLLC shall have no liability whatsoever for payment of the principal sum secured by any Leasehold Mortgage, or any interest accrued thereon or any other sum secured thereby or accruing thereunder, and, except for violation by UMLLC of express obligations set forth herein with respect to the Leasehold Mortgagee or in any other agreement with the Leasehold Mortgagee, the Leasehold Mortgagee shall not be entitled to seek any damages or other amounts against UMLLC for any or all of the same;
- (e) UMLLC shall have no obligation to any Leasehold Mortgagee in the enforcement of the rights and remedies of UMLLC under this Agreement or by Law, except as expressly set forth in this Agreement or in any agreement with the Leasehold Mortgagee and unless such Leasehold Mortgagee has provided UMLLC with notice of its Leasehold Mortgage in accordance with the Leasehold Mortgagee Notice Requirements;

- (f) each Leasehold Mortgage shall provide that if the Concessionaire is in default under the Leasehold Mortgage and the Leasehold Mortgagee gives notice of such default to the Concessionaire, then the Leasehold Mortgagee shall give written notice of such default to UMLLC;
- (g) subject to the terms of this Agreement and the terms of any direct consent agreement executed by and between UMLLC and Leasehold Mortgagee, all rights acquired by a Leasehold Mortgagee under any Leasehold Mortgage shall be subject and subordinate to all of the provisions of this Agreement and to all of the rights of UMLLC hereunder and the Leasehold Mortgagee shall agree to be bound by the terms of this Agreement to the extent applicable to the Leasehold Mortgagee;
- (h) notwithstanding any enforcement of the security of any Leasehold Mortgage, the Concessionaire shall remain liable to UMLLC for the payment of all sums owing to UMLLC under this Agreement and the performance and observance of all of the Concessionaire's covenants and obligations under this Agreement;
- (i) a Leasehold Mortgagee shall not, by virtue of its Leasehold Mortgage, acquire any greater rights or interest in the Utility System than the Concessionaire has at any applicable time under this Agreement, other than such rights granted expressly to such Leasehold Mortgagee pursuant to this Article 19, and each Leasehold Mortgagee, UMLLC, and the Concessionaire shall enter into a consent agreement in a form acceptable to all parties; provided that such consent agreement shall be in a customary form and shall include the rights and protections provided to the Leasehold Mortgagees in this Agreement;
- (j) a Leasehold Mortgagee shall, within ten (10) days after receipt of written request from UMLLC, execute an amendment to its recorded Leasehold Mortgage to conform the legal description of the real property encumbered by such Leasehold Mortgage to conform to the legal description in the Memorandum of Sub-Lease to the extent properly modified pursuant to Section 2.8; and
- (k) a Leasehold Mortgagee shall, within ten (10) days after receipt of written request from UMLLC, execute documentation reasonably acceptable to UMLLC releasing any land or other real property owned by UMLLC from the lien of any Leasehold Mortgage such that such land or real property may be conveyed to a third party without being subject to this Agreement or the Leasehold Mortgage, provided such request is accompanied by an affidavit from UMLLC that such land or other real property does not contain any Utility Facilities or Utility System Assets.

While any Leasehold Mortgage is outstanding, UMLLC shall not agree to any amendment or modification of this Agreement that could reasonably be expected to have a material adverse effect on the rights or interests of the Leasehold Mortgagee or agree to a voluntary surrender or termination of this Agreement by the Concessionaire without the consent of the Leasehold Mortgagee.

Section 19.2. Notices and Payments to Leasehold Mortgagees. Whenever a Leasehold Mortgage exists as to which UMLLC has been provided notice by the holder thereof in accordance with the Leasehold Mortgage Notice Requirements, UMLLC shall, simultaneously with providing the Concessionaire any required notice under this Agreement, provide a copy of such notice to such Leasehold Mortgagee, and no such notice to the Concessionaire shall be effective against the Leasehold Mortgagee until a copy thereof is duly provided to such Leasehold Mortgagee at its address specified in its notice given to UMLLC in accordance with the Leasehold Mortgage Notice Requirements (or any subsequent change of address notice given to UMLLC pursuant to the requirements of Section 20.1). With respect to a Leasehold Mortgage regarding which UMLLC has been provided notice in accordance with the Leasehold Mortgage Notice Requirements, unless the Leasehold Mortgagee has otherwise advised UMLLC in writing, all payments to the Concessionaire to be made by UMLLC under this Agreement shall be made to the institution acting as the collateral agent or depository under the financing secured by such Leasehold Mortgage to the extent UMLLC has been provided the name and mailing address of such institution.

Section 19.3. Leasehold Mortgagee's Right to Cure. The Leasehold Mortgagee shall have a period of ninety (90) Days with respect to any Concessionaire Default beyond any cure period expressly provided to the Concessionaire herein, in which to cure or cause to be cured any such Concessionaire Default; *provided, however*, that such ninety (90) -Day period shall be extended if the Concessionaire Default may be cured but cannot reasonably be cured within such period of ninety (90) Days, and the Leasehold Mortgagee begins to cure such default within such ninety (90) -Day period (or if possession is necessary in order to effect such cure, the Leasehold Mortgagee files the appropriate legal action to commence foreclosure on the liens of the Leasehold Mortgage (or takes other appropriate action to effect a transfer of title to the property subject to such liens) and take possession of the Utility System within such period) and thereafter proceeds with all due diligence to cure such Concessionaire Default (including by proceeding with all due diligence to effect such foreclosure and during such foreclosure action (to the extent practicable) and thereafter to effect such a cure) within a reasonable period of time acceptable to UMLLC, acting reasonably; *provided further* that if a Leasehold Mortgagee's right to cure a Concessionaire Default has not expired, and the Leasehold Mortgagee is acting to cure such Concessionaire Default in accordance with this Section 19.3, then UMLLC shall not exercise its right to terminate this Agreement by reason of such Concessionaire Default. In furtherance of the foregoing, UMLLC shall permit the Leasehold Mortgagee and its Representatives the same access to the Utility System as is permitted to the Concessionaire hereunder. UMLLC shall accept any such performance by a Leasehold Mortgagee as though the same had been done or performed by the Concessionaire. Any payment to be made or action to be taken by a Leasehold Mortgagee hereunder as a prerequisite to keeping this Agreement in effect shall be deemed properly to have been made or taken by the Leasehold Mortgagee if such payment is made or action is taken by a nominee, agent or assignee of the rights of such Leasehold Mortgagee. Any exercise of the Leasehold Mortgagee's rights to cure hereunder shall not result in the assumption by such Leasehold Mortgagee of the Concessionaire's obligations hereunder.

Section 19.4. Rights of the Leasehold Mortgagee.

- (a) Subject to the provisions of this Agreement, a Leasehold Mortgagee may (i) enforce its Leasehold Mortgage in any lawful way, (ii) acquire the Concessionaire Interest

in any lawful way, or (iii) take possession of in any lawful way and manage the Utility System in accordance with the terms of this Agreement. Upon foreclosure of (or without foreclosure upon exercise of any contractual or statutory power of sale under such Leasehold Mortgage or a deed in lieu) and subject to the provisions of Article 17 (applied to the Leasehold Mortgagee as if it were the Concessionaire, except that Section 17.1(c) will not apply), a Leasehold Mortgagee may Transfer the Concessionaire Interest; provided, however, that no Transfer by a Leasehold Mortgagee shall be effective unless the Transfer is made in accordance with Section 17.1. Any Person to whom the Leasehold Mortgagee Transfers the Concessionaire Interest (including such Leasehold Mortgagee) shall take the Concessionaire Interest subject to all of the Concessionaire's obligations under this Agreement.

- (b) Except as provided in Section 19.3, unless and until a Leasehold Mortgagee (i) forecloses or has otherwise taken ownership of the Concessionaire Interest or (ii) has taken possession or control of the Concessionaire Interest, whether directly or by an agent as a mortgagee in possession or a receiver or receiver and manager has taken possession or control of the Concessionaire Interest by reference to the Leasehold Mortgage, the Leasehold Mortgagee shall not be liable for any of the Concessionaire's obligations under this Agreement or be entitled to any of the Concessionaire's rights and benefits contained in this Agreement, except by way of security; *provided, however*, that the Leasehold Mortgagee shall be entitled to cure any Concessionaire Default that requires payment of money by paying such money on the Concessionaire's behalf, prior to the Leasehold Mortgagee taking possession, control or ownership of the Concessionaire Interest. If the Leasehold Mortgagee itself or by an agent or a receiver or a receiver and manager is the owner, or is in control or possession of, the Concessionaire Interest, it shall be bound by all liabilities and obligations of the Concessionaire under this Agreement (including the obligation to engage an Operator). Once the Leasehold Mortgagee goes out of possession or control of the Concessionaire Interest or Transfers the Concessionaire Interest to another Person in accordance with the provisions of this Agreement, the Leasehold Mortgagee shall cease to be liable for any of the Concessionaire's obligations under this Agreement accruing thereafter and shall cease to be entitled to any of the Concessionaire's rights and benefits contained in this Agreement, except, if the Leasehold Mortgage remains outstanding, by way of security.

Section 19.5. Termination of this Agreement; New Agreement.

- (a) Without prejudice to the rights of a Leasehold Mortgagee under Section 19.3, if this Agreement is terminated prior to the expiration of the Term due to a Concessionaire Default (in which case UMLLC shall notify the Leasehold Mortgagee of such termination) or if this Agreement is rejected or disaffirmed pursuant to any bankruptcy Law or proceeding or other similar Law or proceedings affecting creditors' rights generally with respect to a bankruptcy proceeding relating to the Concessionaire or otherwise, UMLLC agrees to enter into a new concession and lease agreement of the Utility System with the Leasehold Mortgagee (or its designee or nominee, provided that such designee or nominee either is controlled

by the Leasehold Mortgagee (or by the holders of the Leasehold Mortgage Debt)) or is Approved by UMLLC as Transferee under Section 17.1) for the remainder of the original stated Term upon all of the covenants, agreements, terms, provisions and limitations of this Agreement, without any charge, penalty, assessment or consideration not specifically provided for in this Section 19.5 (the “New Agreement”), effective as of the date of such termination, but only on and subject to the satisfaction of all of the following requirements and conditions: (i) such Leasehold Mortgagee commits in writing to UMLLC, in a notice delivered to UMLLC, within thirty (30) Days after UMLLC delivers the termination notice to Leasehold Mortgagee (or, if later, upon the termination of any cure period granted to the Leasehold Mortgagee pursuant to Section 19.3) or within thirty (30) Days after the effective date of such rejection or disaffirmance, as the case may be, that the Leasehold Mortgagee (or its designee or nominee) will enter into the New Agreement, which notice is accompanied by a copy of such New Agreement, duly executed and acknowledged by the Leasehold Mortgagee (or its designee or nominee); (ii) the Leasehold Mortgagee (or its designee or nominee) pays or causes to be paid to UMLLC, at the time of the execution and delivery of the New Agreement, all amounts which, at the time of the execution and delivery thereof, would have been past-due or due and payable in accordance with the provisions of this Agreement but for such termination; (iii) provided UMLLC furnishes a statement or invoice for such costs the Leasehold Mortgagee pays or causes to be paid to UMLLC all reasonable costs and expenses (including legal, advisory and other fees), Taxes, fees, charges and disbursements paid or incurred by UMLLC in connection with such Concessionaire Defaults and termination, the recovery of possession from the Concessionaire, and in connection with the preparation, execution and delivery of the New Agreement and related agreements and documents specified in such statement or invoice; and (iv) such Leasehold Mortgagee (or its designee or nominee), at the time of such written request, cures all Concessionaire Defaults under this Agreement (curable by the payment of money) existing immediately prior to the termination of this Agreement, or, if such Concessionaire Defaults cannot be cured by the payment of money, such Leasehold Mortgagee (or its designee or nominee) commits to UMLLC in the New Agreement to proceed both promptly and diligently, upon the execution of the New Agreement, to cure all such other Concessionaire Defaults to the extent such Concessionaire Defaults are capable of cure by a Person other than the original Concessionaire and, if possession is necessary in order to cure such other Concessionaire Defaults, to proceed both promptly and diligently to obtain the possession required to cure any such other Concessionaire Defaults (and such cure shall be a covenant in the New Agreement).

- (b) Nothing contained in this Section 19.5 shall be deemed to limit or affect UMLLC’s interests in and to such Utility System upon the expiration of the Term of the New Agreement. The provisions of this Section 19.5 shall survive the termination of this Agreement and shall continue in full force and effect thereafter to the same extent as if this Section 19.5 were a separate and independent contract made by UMLLC, the Concessionaire and the Leasehold Mortgagee and, if the Leasehold Mortgagee satisfies the conditions to execute a New Agreement, from the effective

date of such termination of this Agreement to the date of execution and delivery of the New Agreement, the Leasehold Mortgagee may use and enjoy the leasehold estate created by this Agreement without hindrance by UMLLC, but only on and subject to the terms and provisions of this Agreement.

- (c) If the circumstances described in Section 19.5(a) occur, and UMLLC determines, based on the written legal advice of counsel, that termination of this Agreement and the entry into a New Agreement by and among UMLLC and the Leasehold Mortgagee could violate applicable provisions of the Laws of the State of Louisiana governing procurement by UMLLC then, in lieu of entering in a New Agreement and in satisfaction of its obligations under this Section 19.5, UMLLC agrees to enter into an Assignment and Assumption Agreement pursuant to Section 19.8.

Section 19.6. Recognition of Leasehold Mortgagee. If there is more than one Leasehold Mortgagee, only that Leasehold Mortgagee (who, for the avoidance of doubt, may act on behalf of one or more lender groups as contemplated by Section 19.1), to the exclusion of all other Leasehold Mortgagees, whose notice was earliest received by UMLLC pursuant to the Leasehold Mortgagee Notice Requirements, shall have the right to exercise the rights as a Leasehold Mortgagee under this Article 19 vis-à-vis UMLLC, unless such Leasehold Mortgagee has designated in writing another Leasehold Mortgagee to exercise such rights in which case the other Leasehold Mortgagee may exercise such rights, provided that such requirement shall not limit such additional Leasehold Mortgagees' rights hereunder. Such Leasehold Mortgagee may act as agent for a group or syndicate of one or more Institutional Lenders and such Leasehold Mortgagee and Institutional Lenders may freely assign or sell interests and/or participations in the loans to any other Institutional Lender.

Section 19.7. UMLLC's Right to Purchase Leasehold Mortgages.

- (a) If any default by the Concessionaire has occurred under a Leasehold Mortgage and has not been cured within applicable cure periods, or any act, condition or event has occurred which would permit a Leasehold Mortgagee to declare all or part of the indebtedness secured by a Leasehold Mortgage to be immediately due and payable (or, in the case of a Leasehold Mortgage that is a lease, to terminate the lease), then UMLLC shall have thirty (30) Days after the date on which such Leasehold Mortgagee shall serve notice upon UMLLC in writing ("Leasehold Mortgagee's Notice") that such Leasehold Mortgagee intends to commence proceedings to foreclose the Leasehold Mortgage or, in the case of a Leasehold Mortgagee that is a Lessor to terminate the lease with the Concessionaire (stating the calculation of the purchase price pursuant to Section 19.7(c)), during which thirty (30) -Day period UMLLC shall have the right and option (the "UMLLC's Option") to purchase from all Leasehold Mortgagees their Leasehold Mortgages, upon the terms and subject to the conditions contained in this Section 19.7.
- (b) UMLLC's Option shall be exercised by notice served upon the Concessionaire and all Leasehold Mortgagees within such thirty (30) -Day period. If UMLLC's Option is duly and timely exercised, UMLLC shall purchase and all Leasehold Mortgagees shall assign their Leasehold Mortgages to UMLLC (or its designee) on the date

which is sixty (60) Days after the date on which a Leasehold Mortgagee's Notice is served upon UMLLC. The closing shall take place at a mutually convenient time and place.

- (c) The purchase price payable by UMLLC shall be equal to the aggregate amounts secured by such Leasehold Mortgages (including principal, interest, fees, premiums, Breakage Costs and other costs, expenses (including attorneys' fees) and any other amounts secured thereby) as of the closing date of the purchase. The purchase price shall be paid in full in cash at closing by wire transfer or other immediately available funds. The purchase price shall be paid by UMLLC to each respective Leasehold Mortgagee, to be applied by the Leasehold Mortgagee to the amounts secured by the Leasehold Mortgage owed to such Leasehold Mortgagee, subject to the priorities of lien of such Leasehold Mortgages.
- (d) At the closing and upon payment in full of the purchase price each Leasehold Mortgagee shall assign its Leasehold Mortgage to UMLLC, together with any security interest held by it in the Concessionaire Interest, without recourse, representations, covenants or warranties of any kind, provided that such Leasehold Mortgages and security interests shall be deemed modified to secure the amount of the aggregate purchase price paid by UMLLC to all Leasehold Mortgagees (rather than the indebtedness theretofore secured thereby) payable on demand, with interest and upon the other items referred to in this Section 19.7(d). Each such assignment shall be in form for recordation or filing, as the case may be. UMLLC shall be responsible for paying any Taxes payable to any Governmental Authority upon such assignment. Such assignment shall be made subject to such state of title of the Utility System as shall exist at the date of exercise of UMLLC's Option.
- (e) Any Leasehold Mortgage shall contain an agreement of the Leasehold Mortgagee to be bound by the provisions of this Section 19.7, and UMLLC shall have the right to receive all notices of default under any Leasehold Mortgage.

Section 19.8. Assignment and Assumption Agreement.

- (a) The provisions of this Section 19.8 shall be in effect whenever either (i) UMLLC has made the determination contemplated by Section 19.5(c) or (ii) UMLLC, with the written consent of the Leasehold Mortgagee, has determined to proceed under this Section 19.8 in lieu of under Section 19.5.
- (b) Without prejudice to the rights of a Leasehold Mortgagee under Section 19.3, if either (i) UMLLC has given a notice of termination of this Agreement due to Concessionaire Default pursuant to Section 16.1(b), or (ii) this Agreement is rejected or disaffirmed pursuant to any bankruptcy Law or proceeding or other similar Law or proceedings affecting creditors' rights generally with respect to a bankruptcy proceeding relating to the Concessionaire or otherwise, UMLLC agrees to cooperate with a Leasehold Mortgagee in order to effectuate such Leasehold Mortgagee's rights under the Leasehold Mortgage to step-in, assume or assign this Agreement, in accordance with the procedures, terms and conditions of this

Section 19.8 without any charge, penalty, assessment, or consideration not specifically provided for in this Section 19.8.

- (c) Upon notification and satisfaction of all of the conditions and requirements in Section 19.8(d), UMLLC agrees that this Agreement shall not be deemed terminated, but may be assumed by a Leasehold Mortgagee or by a designee or nominee of such Leasehold Mortgagee who is either controlled by the Leasehold Mortgagee (or by the holders of the Leasehold Mortgage Debt) or is Approved by UMLLC as a Transferee under Section 17.1, for the remainder of the original stated Term of this Agreement, and as evidence of such assignment and assumption UMLLC agrees to execute an amended and restated concession and lease agreement for the Utility System upon all of the covenants, agreements, terms, provisions and limitations of this Agreement (the “Assignment and Assumption Agreement”).
- (d) This Agreement may be so assigned and assumed pursuant to an Assignment and Assumption Agreement upon and subject to satisfaction of all of the following requirements and conditions:
 - (i) Such Leasehold Mortgagee must commit in writing to UMLLC, in a notice delivered to UMLLC within the later of thirty (30) Days after UMLLC delivers the termination notice to Leasehold Mortgagee or upon the termination of any cure period granted to such Leasehold Mortgagee pursuant to Section 19.3, or within thirty (30) Days after the effective date of any rejection or disaffirmance of this Agreement in a bankruptcy proceeding, as the case may be, that such Leasehold Mortgagee (or its designee or nominee) will assume this Agreement and enter into the Assignment and Assumption Agreement, which notice is accompanied by a copy of such Assignment and Assumption Agreement duly executed and acknowledged by such Leasehold Mortgagee (or its designee or nominee).
 - (ii) Such Leasehold Mortgagee (or its designee or nominee) shall pay or cause to be paid to UMLLC, at the time that the Assignment and Assumption Agreement is fully executed, all amounts which, at the time of the execution and delivery thereof, would have been past-due or due and payable in accordance with the provisions of this Agreement.
 - (iii) Such Leasehold Mortgagee (or its designee or nominee) shall pay or cause to be paid to UMLLC all reasonable costs and expenses (including legal fees), Taxes, fees, charges and disbursements paid or incurred by UMLLC in connection with such defaults and notice of termination, the recovery of possession from the Concessionaire, and in connection with the preparation, execution and delivery of the Assignment and Assumption Agreement and related agreements and documents. UMLLC shall provide an invoice to such Leasehold Mortgagee of such costs, and the Leasehold Mortgagee or its designee or nominee shall pay such invoiced costs within five (5) Days of the receipt of such invoice.

- (iv) Such Leasehold Mortgagee (or its designee or nominee), at the time of the notice provided under Section 19.8(d)(i), shall cure all Concessionaire Defaults under this Agreement (including all such Concessionaire Defaults curable by the payment of money) existing immediately prior to the notice of termination issued pursuant to Section 16.1(b), or, if such Concessionaire Defaults cannot be cured by the payment of money, such Leasehold Mortgagee (or its designee or nominee) shall commit to UMLLC in the Assignment and Assumption Agreement to proceed both promptly and diligently, upon the execution of the Assignment and Assumption Agreement, to cure all such other defaults to the extent such defaults are capable of cure by a Person other than the original Concessionaire and, if possession is necessary in order to cure such other Concessionaire Defaults, to proceed both promptly and diligently to obtain the possession required to cure any such other defaults (and such obligation to cure shall be a covenant in the Assignment and Assumption Agreement).
- (e) If a Leasehold Mortgagee gives UMLLC a notice as provided in Section 19.8(d)(i), UMLLC and Leasehold Mortgagee agree to cooperate with respect to taking any appropriate actions required to regain and transfer possession of the Utility System and the Utility System Assets, including (i) seeking surrender of possession in any bankruptcy proceedings; (ii) seeking relief from any automatic stay in bankruptcy provisions and pursuit of state law remedies to obtain possession and to foreclose on the Leasehold Mortgage interest and assume the Concessionaire's position as provided in Section 19.4 of this Agreement; *provided* that any costs incurred by UMLLC under this provision shall be reimbursed by the Leasehold Mortgagee (or its designee or nominee) as provided in Section 19.8(d)(iii).

Section 19.9. Right to Dispute Resolution. In each case specified in this Agreement in which resort to dispute resolution is authorized, a Leasehold Mortgagee shall have the right and privilege if an event of default under the Leasehold Mortgage then exists and notice has been given to UMLLC as contemplated by Section 19.1(f), in the Concessionaire's name, place and stead, to obtain and participate in such dispute resolution upon notice to UMLLC in accordance with Article 18; *provided* that the Leasehold Mortgagee agrees to be bound by the outcome of the dispute resolution process.

ARTICLE 20 MISCELLANEOUS

Section 20.1. Notice. All notices by the Concessionaire or UMLLC, approvals or consents by the Concessionaire, and Approvals by UMLLC (each, a "Notice") required or permitted by this Agreement shall be in writing, shall state specifically that they are being given pursuant to this Agreement, and shall be delivered by email, nationally recognized overnight courier service, or certified or registered mail (return receipt requested and postage prepaid) for the attention of the persons and to the addresses or email addresses shown below (or such other persons, address or email addresses as either Party may from time to time designate by a Notice to the other):

(a) in the case of UMLLC:

(i) for delivery by mail:

Utilities Modernization LLC
c/o LSU Real Estate and Facilities Foundation
Attn: Vice President & General Counsel
3796 Nicholson Drive
Baton Rouge, LA 70802

With a copy to:

[•]

(ii) for delivery by email:

Vice President & General Counsel (Foundation)
Email: lgreco@lsufoundation.org

With a copy to:

[•]

Email: [•]

(b) in the case of the Concessionaire:

(i) for delivery by mail:

[•]

With a copy to:

[•]

(ii) for delivery by email:

[•]

With a copy to:

[•]

Email: [•]

A Notice shall be deemed to have been sent and received (i) on the Day it is delivered, or if such Day is not a Business Day or if the Notice is received after ordinary office hours (time of place of receipt), the Notice shall be deemed to have been sent and received on the next Business Day, or (ii) on the fourth (4th) Business Day after mailing if sent by U.S. registered or certified

mail. Each Party shall use commercially reasonable efforts to deliver an electronic copy of each Notice provided by mail in accordance with the foregoing via email to the persons and email addresses designated pursuant to the foregoing to receive Notices provided by email.

All communications other than Notices that are required or permitted by this Agreement shall be in writing, shall state specifically that they are being given pursuant to this Agreement and shall be delivered by email to the persons and email addresses shown below (or such other persons or email addresses as either Party may from time to time designate by a Notice to the other):

(x) in the case of UMLLC:

[•]

Email: [•]

(c) in the case of the Concessionaire:

[•]

Email: [•]

Section 20.2. Entire Agreement. This Agreement constitutes the entire agreement between the Parties pertaining to the subject matter hereof and supersedes all prior agreements, negotiations, discussions, and understandings, written or oral, between the Parties. There are no representations, warranties, conditions, or other agreements, whether direct or collateral, or express or implied, that form part of or affect this Agreement, or that induced any Party to enter into this Agreement or on which reliance is placed by any Party, except as specifically set forth in this Agreement. The Parties acknowledge and agree that (i) each has substantial business experience and is fully acquainted with the provisions of this Agreement, (ii) the provisions and language of this Agreement have been fully negotiated, and (iii) no provision of this Agreement shall be construed in favor of any Party or against any Party by reason of such provision of this Agreement having been drafted on behalf of one Party rather than the other.

Section 20.3. Amendment. This Agreement may be amended, changed, or supplemented only by a written agreement signed by the Parties.

Section 20.4. Waiver of Rights. Any waiver of, or consent to depart from, the requirements of any provision of this Agreement shall be effective only if it is in writing and signed by the Party giving it, and only in the specific instance and for the specific purpose for which it has been given. No failure on the part of any Party to exercise, and no delay in exercising, any right under this Agreement shall operate as a waiver of such right. No single or partial exercise of any such right shall preclude any other or further exercise of such right or the exercise of any other right.

Section 20.5. Severability. Each provision of this Agreement shall be valid and enforceable to the fullest extent permitted by applicable Law. The invalidity of any one or more phrases, sentences, clauses, or sections contained in this Agreement shall not affect the remaining portions of this Agreement or any part thereof. If any provision of this Agreement or the application thereof to any Person or circumstance is held or deemed to be or determined to be

invalid, inoperative, or unenforceable in any particular case in any particular jurisdiction or jurisdictions because it conflicts with any other provision or provisions hereof or of any applicable Law, or public policy, or for any other reason, (i) such circumstance shall not have the effect of rendering the provision in question inoperative or unenforceable in any other case or circumstance, or rendering any other provision or provisions herein contained invalid, inoperative or unenforceable to any extent whatever, and (ii) the Parties shall negotiate in good faith to amend this Agreement to implement the provisions set forth herein. If the Parties cannot agree on an appropriate amendment, either Party may refer the matter for determination pursuant to the dispute resolution procedure in Article 18. If, by means of the dispute resolution procedure, the Parties are unable, as a result of applicable Law, to resolve the matter in a manner that effectively entitles UMLLC to have the same rights after the aforesaid determination of invalidity or unenforceability as before, UMLLC shall have the right to enact, and cause to come into force, any Law to provide for the same or substantially the same rights as were determined to be invalid or unenforceable.

Section 20.6. Governing Law; Waiver of Jury Trial. This Agreement shall be governed by, and interpreted and enforced in accordance with, the Laws in force in the State of Louisiana (excluding any conflict of laws rule or principle which might refer such interpretation to the Laws of another jurisdiction). **EACH OF THE PARTIES HEREBY IRREVOCABLY WAIVES ANY AND ALL RIGHT TO TRIAL BY JURY IN ANY LEGAL PROCEEDING ARISING OUT OF OR RELATED TO THIS AGREEMENT OR THE TRANSACTIONS CONTEMPLATED HEREBY.**

Section 20.7. Submission to Jurisdiction. Subject to Article 18, any action or proceeding against any Party relating in any way to this Agreement may be brought and enforced in the state courts in the State of Louisiana in the Parish of East Baton Rouge, and each of the Concessionaire and UMLLC hereby irrevocably submits to the jurisdiction of such courts with regard to any such action or proceeding, and irrevocably waives, to the fullest extent permitted by applicable Law, any objection it may have now or hereafter have to the laying of venue of any such action or proceeding in such courts and any claim that any such action or proceeding brought in any such court has been brought in an inconvenient forum. Service of process on the Concessionaire may be made either (i) by delivery to the Concessionaire's registered agent for service of process in the State of Louisiana, or (ii) by such other lawful means under the Laws of the State of Louisiana. Service of process on UMLLC may be made either (i) by delivery to UMLLC's registered agent for service of process in the State of Louisiana, or (ii) by such other lawful means under the Laws of the State of Louisiana. If the Concessionaire is presented with a request for Documents by any administrative agency or with a subpoena duces tecum regarding any Documents which may be in its possession by reason of this Agreement, the Concessionaire, unless prohibited by Law, shall give prompt notice to UMLLC. UMLLC may contest such process by any means available to it before such Documents are submitted to a court or other third party; *provided, however*, that the Concessionaire shall not be obligated to withhold such delivery beyond that time as may be ordered by the court or administrative agency or required by Law, unless the subpoena or request is quashed or the time to produce is otherwise extended.

Section 20.8. Further Acts. The Parties shall do or cause to be done all such further acts and things as may be reasonably necessary or desirable to give full effect to this Agreement. Without limiting the foregoing, each Party will, at any time and from time to time, execute and deliver or cause to be executed and delivered such further instruments and assurances and take

such further actions as may be reasonably requested by the other Party in order to cure any defect in the execution and/or delivery of this Agreement.

Section 20.9. Costs. Except as otherwise provided in this Agreement, each Party shall be responsible for its own costs and expenses incurred in connection with performing and observing its obligations and covenants under this Agreement.

Section 20.10. Interest. Any amount payable under this Agreement and not paid when due shall bear interest at a variable nominal rate per annum equal on each Day to the Bank Rate then in effect, from the date such payment is due until payment and both before and after judgment.

Section 20.11. Inurement and Binding Effect. This Agreement shall inure to the benefit of the Parties and their respective permitted successors and assigns and is binding upon the Parties and their respective successors and assigns.

Section 20.12. No Partnership or Third Party Beneficiaries. Except as expressly provided herein to the contrary, nothing contained in this Agreement shall constitute or be deemed to create a partnership, joint venture or principal and agent relationship between UMLLC and the Concessionaire, nor shall any term or provision hereof be construed in any way to grant, convey or create any rights or interests to any Person not a party to this Agreement, other than, in the case of Section 3.11, Section 10.2, Section 12.3, Section 13.4, Section 14.2, Section 16.3, Section 17.1, Section 17.2 and Article 19, any Leasehold Mortgagee.

Section 20.13. Cumulative Remedies. The rights, remedies, powers, and privileges herein provided are cumulative and not exclusive of any rights, remedies, powers, and privileges provided by Law, except for the remedies available to UMLLC for a breach of the Performance Standards or a KPI Event, which shall be limited to those expressly set forth herein. Notwithstanding the foregoing, where this Agreement provides for liquidated damages (except with respect to the liquidated damages described in Section 15.4 and Section 22.4), such liquidated damages shall be the sole exclusive remedy of UMLLC or the Concessionaire, as applicable, and UMLLC and the Concessionaire hereby irrevocably waive any right to assert a claim against the other party based on a legal theory that a remedy provided herein for such breach or act triggering the liquidated damages fails of its essential purpose.

Section 20.14. Counterparts; Electronic Execution. This Agreement may be executed in any number of counterparts which, taken together, shall constitute one and the same agreement. This Agreement shall be effective when it has been executed by each Party and delivered to both Parties. To evidence the fact that it has executed this Agreement, a Party may send a copy of its executed counterpart to the other Party by email or other means of electronic transmission. Such Party shall be deemed to have executed and delivered this Agreement on the date it sent such email or other means of electronic transmission. In such event, such Party shall forthwith deliver to the other Party an original counterpart of this Agreement executed by such Party.

Section 20.15. Time of the Essence. Time is of the essence for this Agreement.

ARTICLE 21 DESIGN AND CONSTRUCTION

Section 21.1. General Duties. In connection with the Initial Modernization Project, the Concessionaire shall:

- (a) furnish all design, engineering, and other services, provide construction management and all D&C Work, including the supply of all materials, equipment, labor, and installations, and undertake all efforts necessary or appropriate to construct the Initial Modernization Project and maintain it during construction, so as to achieve IMP Substantial Completion by the IMP Substantial Completion Long Stop Date and IMP Final Acceptance by the IMP Final Acceptance Long Stop Date;
- (b) perform the Construction Work in accordance with the approved Final Design;
- (c) ensure that the Concessionaire's Representative, or a designated person approved by the UMLLC, is present at the Initial Modernization Project at all times during performance of the Construction Work;
- (d) comply with, and require that all Contractors comply with, all requirements of all applicable Laws;
- (e) cooperate with UMLLC and any Governmental Authority with jurisdiction in all matters relating to the applicable portions of the D&C Work, including their review, inspection and oversight of the design and construction;
- (f) provide quality management and quality assurance of all the work in respect of the D&C Work in accordance with [●]; and
- (g) use commercially reasonable efforts to mitigate delay to design and construction of the Initial Modernization Project, including by re-sequencing, reallocating, or redeploying the Concessionaire's and its Contractors' forces to other work, as appropriate.

Section 21.2. Performance of D&C Work. The Concessionaire and its Contractor shall perform or cause to be performed the D&C Work in accordance with:

- (a) good industry practice;
- (b) the requirements, terms and conditions set out in this Agreement, including the approved Final Design;
- (c) all applicable Laws; and
- (d) the requirements, terms and conditions set forth in all Authorizations.

Section 21.3. Design Development and Construction Commencement. Except for the development of the Final Design in accordance with Section 2.4(f), neither the Concessionaire nor

its Contractor shall commence any D&C Work until authorized in accordance with Section 22.1(a), Section 22.1(b) and Section 22.1(c).

Section 21.4. Suspension of Construction Work.

- (a) UMLLC shall at any time have the right and authority to suspend, in whole or in part, the Construction Work by written order to the Concessionaire. Any such written order will be supported by UMLLC's reasons for the required suspension of the Construction Work.
- (b) Any suspension of the Construction Work by UMLLC pursuant to this Section 21.4 will entitle the Concessionaire to relief pursuant to Section 15.1(c) and constitute a Compensation Event except where the suspension order is made in response to:
 - (i) any failure by the Concessionaire to comply with any applicable Law, safety standard or Authorization (including failure to handle, preserve, and protect archaeological, paleontological, or cultural remains or failure to handle Hazardous Substances, in accordance with applicable Laws and Governmental Approvals);
 - (ii) the Concessionaire's failure to ensure skilled and experienced personnel are furnished for the proper performance of the Construction Work in accordance with the requirements set out in [•];
 - (iii) the Concessionaire's failure to provide UMLLC with proof of (i) insurance coverage and payment in accordance with Section 13.3(a) or (ii) the D&C Security; or
 - (iv) the existence of conditions unsafe for workers, other Initial Modernization Project personnel or the general public, including failures to comply with safety standards (but only if such condition does not arise as a direct result of a Compensation Event or an event that entitles the Concessionaire to relief pursuant to Section 15.1(c)).
- (c) Any suspension order made in response to matters referred to in Section 21.4(b) shall cease to apply as soon as the relevant matter has been rectified or remedied to the reasonable satisfaction of UMLLC.

Section 21.5. Removal of IMP Contractor.

- (a) The IMP Contractor shall, at all times in connection with the design, construction, delivery and completion of the Initial Modernization Project, be under the direction, supervision and control (by ownership, contract or otherwise) of the Concessionaire, and no delegation by the Concessionaire to the IMP Contractor

(including pursuant to the Drop-Down DB Contract) shall relieve the Concessionaire of any obligations, duties or liability hereunder.

- (b) The Concessionaire shall have the right, to the extent provided in the Drop-Down DB Contract or any other agreement between the Concessionaire and the IMP Contractor, to terminate and replace the IMP Contractor, provided that the Concessionaire shall not engage or appoint a replacement IMP Contractor unless UMLLC has Approved such replacement IMP Contractor and the terms of any such engagement. The Concessionaire shall immediately notify UMLLC upon the termination or resignation of the IMP Contractor. UMLLC shall have the right, acting reasonably, to withhold Approval of any proposed replacement IMP Contractor, including for any of the following reasons: (i) UMLLC reasonably determines that the engagement of such proposed IMP Contractor is prohibited by applicable Law or this Agreement; (ii) UMLLC reasonably determines that such proposed IMP Contractor is not capable of performing the Initial Modernization Project in accordance with this Agreement, which determination may be based upon one or more of the following factors: (1) the ability of the proposed IMP Contractor to construct and deliver the Initial Modernization Project in a manner that complies with the Final Design; (2) the financial strength, capitalization and integrity of the proposed IMP Contractor, its direct or indirect beneficial owners and some or all of their respective Affiliates providing a guaranty of the IMP Contractor's obligations (which guaranty shall not be required to run to the benefit of UMLLC); (3) the experience of the proposed IMP Contractor in performing work and projects substantially similar to the Initial Modernization Project; (4) the background and reputation of the proposed IMP Contractor, its direct or indirect beneficial owners, each of their respective officers, directors and employees and each of their respective Affiliates (including the absence of criminal, civil or regulatory claims or actions against any such Person and the quality of any such Person's past or present performance on other projects); and (5) the proposed terms of the engagement of the proposed IMP Contractor, including the fee being charged by the IMP Contractor, length of the term of the engagement and any restrictions on transfer by the IMP Contractor of its obligations and change in control of the proposed IMP Contractor. No termination or replacement of the IMP Contractor shall relieve the Concessionaire of any obligations, duties or liability hereunder or extend any time period for the Concessionaire's performance hereunder.
- (c) A Change in Control of the IMP Contractor shall be deemed to be the appointment of a replacement IMP Contractor subject to UMLLC's Approval pursuant to Section 21.5(b).

Section 21.6. Performance and Payment Security

- (a) Prior to the commencement of D&C Work, the Concessionaire shall furnish, [or cause the IMP Contractor to furnish,] the following:
- (i) a performance bond (substantially in the form of the most current version of The American Institute of Architects AIA Document 312) in an amount

equal to one hundred percent (100%) of the Approved Budgeted Amount for the Initial Modernization Project (the “Performance Bond”); and

- (ii) a payment bond (substantially in the form of the most current version of The American Institute of Architects AIA Document 312) in an amount equal to one hundred percent (100%) of the Approved Budgeted Amount for the Initial Modernization Project (the “Payment Bond”).
- (b) Each of the Performance Bond and the Payment Bond must be issued by a surety or an insurance company authorized to issue bonds in the State that is rated in the top two categories by two of the three nationally recognized rating agencies or at least “A” or better and “Class VIII” or better according to A.M. Best’s Financing Strength Rating and Financial Size Category and listed on U.S. Treasury Circular 570.
- (c) Each of the Performance Bond and the Payment Bond shall name the State of Louisiana, UMLLC, their agents, officials, and employees, the Concessionaire and the Leasehold Mortgagee, as their interests may appear as additional obligees. The claims of any such additional obligee with respect each of the Performance Bond and the Payment Bond shall rank *pari passu* in priority with the claims of all other additional obligees.
- (d) The Concessionaire shall maintain, or cause the IMP Contractor to maintain, each of the Performance Bond and the Payment Bond until the second (2nd) anniversary of the IMP Substantial Completion Date.

ARTICLE 22
NOTICES TO PROCEED; IMP SUBSTANTIAL COMPLETION; IMP FINAL
ACCEPTANCE

Section 22.1. Notices to Proceed. With respect to the Initial Modernization Project:

- (a) *Notice to Proceed – 1.*
 - (i) UMLLC anticipates issuing a notice to the Concessionaire (“NTP1”) promptly following approval of the Final Design and the Approved Budgeted Amount for the Initial Modernization Project in accordance with Section 2.4(f), and shall in any case issue NTP1 within three (3) Business Days after approval of the Final Design and such Approved Budgeted Amount.
 - (ii) Following issuance of NTP1, the Concessionaire is authorized to perform the works and activities specified in Section 1 (*NTP1 Conditions*) of Part 1 of Schedule 21.
- (b) *Notice to Proceed – 2.*

- (i) Upon satisfaction of the conditions precedent set out in Section 2 of Part 1 (*NTP2 Conditions*) of Schedule 21, UMLLC shall issue a notice to the Concessionaire (“NTP2”).
 - (ii) Following issuance of NTP2, the Concessionaire is authorized to perform the works and activities specified in Section 2 (*NTP2*) of Schedule 21.
- (c) *Notice to Proceed – 3.*
- (i) Upon satisfaction of the conditions precedent set out in Section 3 (*NTP3 Conditions*) of Part 1 of Schedule 21, UMLLC shall issue a notice to the Concessionaire (“NTP3”).
 - (ii) Following issuance of NTP3, the Concessionaire is authorized to commence all other work and activities pertaining to the Initial Modernization Project, subject to any requirement to obtain acceptance of applicable submittals in accordance with Section 3 (*NTP3 Conditions*) of Part 3 of Schedule 21.
 - (iii) If the Concessionaire has not satisfied all the conditions precedent set out in Section 3 (*NTP3 Conditions*) of Part 1 of Schedule 21, UMLLC may elect to issue a notice to the Concessionaire authorizing the Concessionaire to commence certain works prior to the satisfaction of the remaining conditions precedent, as specified and subject to any conditions in UMLLC’s notice.

Section 22.2. IMP Substantial Completion.

- (a) UMLLC will issue a written certificate that the Concessionaire has achieved IMP Substantial Completion upon satisfaction (or waiver by UMLLC, in its sole discretion) of each of the conditions set forth in Part 2 of Schedule 21 and in accordance with the terms of this Section 22.2. On the IMP Substantial Completion Date, the IMP shall be (i) deemed to be part of the Utility System and the Utility System Facilities for purposes of this Agreement, and (ii) included in the Utility System to be operated and the Utility System Services to be performed by the Concessionaire pursuant to this Agreement.
- (b) The Concessionaire shall prepare a detailed plan for the completion of all remaining D&C Work (“D&C Closeout Plan”), which shall include:
 - (i) the SC Punch List and the draft FA Punch List; and
 - (ii) the timetable for carrying out Construction Work, including:
 - (A) the activities to be carried out between IMP Substantial Completion and IMP Final Acceptance and included in the FA Punch List; and
 - (B) any other activities to be carried out after IMP Final Acceptance; and

The Concessionaire shall submit the D&C Closeout Plan to UMLLC at least ninety (90) days prior to the date on which the Concessionaire anticipates achieving IMP Substantial Completion.

- (c) The Concessionaire shall implement the accepted D&C Closeout Plan and regularly update the SC Punch List and the FA Punch List, provided that the Concessionaire will not transfer any items from the SC Punch List to the FA Punch List without the prior written acceptance of UMLLC.
- (d) The Concessionaire shall provide UMLLC with not less than thirty (30) days' prior written notification of the date the Concessionaire anticipates achieving IMP Substantial Completion.
- (e) During the thirty (30)-day period specified in Section 22.1(d):
 - (i) the Concessionaire and UMLLC shall meet and confer and exchange information on a regular cooperative basis and shall at a minimum meet twice a week;
 - (ii) UMLLC may conduct:
 - (A) an inspection of the entire Initial Modernization Project and its components;
 - (B) a review of the IMP Design Documents and Construction Documents; and
 - (C) such other investigation and review of reports, data and documentation as may be necessary to evaluate whether all of the conditions to IMP Substantial Completion have been satisfied; and
 - (iii) the Concessionaire and UMLLC shall agree the final FA Punch List.
- (f) Within five (5) Business Days of completion of the inspections, reviews and investigations specified in Section 22.1(e)(ii), UMLLC may either:
 - (i) issue the written certificate of IMP Substantial Completion (“Certificate of IMP Substantial Completion”); or
 - (ii) notify the Concessionaire in writing setting forth, as applicable, why the Initial Modernization Project has not reached IMP Substantial Completion.
- (g) If UMLLC issues a notice under Section 22.1(f)(ii) and the Concessionaire:
 - (i) does not dispute UMLLC’s assessment, then the processes set forth in Sections 22.2(d), 22.2(e) and 22.2(f) shall be repeated until UMLLC issues a Certificate of IMP Substantial Completion; or

- (ii) disputes UMLLC's assessment, the Concessionaire may refer the dispute for resolution in accordance with Section 18 and:
 - (A) where the dispute is determined in favor of the Concessionaire, UMLLC shall issue the Certificate of IMP Substantial Completion; or
 - (B) where the dispute is determined in favor of UMLLC, then the processes set forth in Sections 22.2(d), 22.2(e) and 22.2(f) shall be repeated.
- (h) If Sections 22.2(g)(i) or 22.2(g)(ii)(B) apply and UMLLC determines that it does not require the full thirty (30) day period under Section 22.2(e) to re-conduct relevant inspections and investigations, UMLLC may notify the Concessionaire that a shorter period will apply.
- (i) On the IMP Substantial Completion Date, the Concessionaire shall pay to the University in readily available funds (according to instructions provided by the University to the Concessionaire not later than three (3) Days prior to such date) the Unexpended Contingency Amount.

Section 22.3. IMP Final Acceptance.

- (a) UMLLC will issue a written certificate that the Concessionaire has achieved IMP Final Acceptance upon satisfaction (or waiver by UMLLC, in its sole discretion) of each of the conditions set forth in Part 3 of Schedule 21 and in accordance with the terms of this Section 22.3.
- (b) Promptly after achieving IMP Substantial Completion, the Concessionaire shall perform all remaining Construction Work for the Initial Modernization Project in accordance with the accepted D&C Closeout Plan, including completion of all FA Punch List items.
- (c) The Concessionaire shall provide UMLLC with not less than thirty (30) days' prior written notification of the date the Concessionaire anticipates achieving IMP Final Acceptance.
- (d) During the thirty (30) day period specified in Section 22.3(c):
 - (i) the Concessionaire and UMLLC shall meet and confer and exchange information on a regular cooperative basis; and
 - (ii) UMLLC may conduct:
 - (A) an inspection of the FA Punch List items;
 - (B) a review of the Record Design Documents; and

- (C) such other investigation as may be necessary to evaluate whether the conditions to IMP Final Acceptance are satisfied.
- (e) Within five (5) Business Days of completion of the inspections, reviews and investigations specified in Section 22.3(d)(ii), UMLLC may either:
 - (i) issue a certificate of IMP Final Acceptance (“Certificate of IMP Final Acceptance”); or
 - (ii) notify the Concessionaire in writing setting forth, as applicable, why IMP Final Acceptance has not been achieved in which case the processes set out in Sections 22.3(c), 22.3(d) and 22.3(e) shall be repeated until UMLLC issues a Certificate of IMP Final Acceptance.

Section 22.4. Liquidated Damages for Failure to Achieve IMP Substantial Completion or IMP Final Acceptance.

- (a) The Parties acknowledge and agree that breaches or failures by the Concessionaire of the kind identified in this Section 22.4 would cause significant harm to UMLLC and the University, including loss of use, enjoyment and benefit of the Initial Modernization Project, injury to the credibility and reputation of UMLLC and the University with policy makers and with the University community who depend on and expect availability of service, and additional costs of administering this Agreement (including engineering, legal, accounting, overhead and other administrative costs); and that such harm is incapable of being accurately determined. The Parties further acknowledge and agree that the liquidated damages stipulated in this Section 22.4 as remedies for such breaches or failures reasonably approximate the appropriate compensation for the anticipated harm.
- (b) UMLLC’s right to, and imposition of, liquidated damages pursuant to this Section 22.4 are in addition, and without prejudice, to any other rights and remedies available to UMLLC under this Agreement, at law or in equity respecting the breach, failure to perform or the Concessionaire Default that is the basis for the liquidated damages or any other breach, failure to perform or the Concessionaire Default, except for recovery of the monetary damage that the liquidated damages are intended to compensate. Liquidated damages are not intended to, and do not, liquidate the Concessionaire’s liability under the payment obligation provisions of Section 12, even though third-party claims against Indemnified Parties may arise out of the same event, breach or failure that gives rise to such liquidated damages. Permitting or requiring the Concessionaire to continue and finish the Construction Work or any part thereof after the Planned IMP Substantial Completion Date or IMP Final Acceptance Deadline shall not act as a waiver of UMLLC’s right to receive liquidated damages hereunder or any rights or remedies otherwise available to UMLLC.
- (c) The Concessionaire shall pay any liquidated damages owing under this Section 22.4 within thirty (30) days after UMLLC delivers invoice or demand therefor to the

Concessionaire. Liquidated damages shall be due and payable to UMLLC without right of offset, deduction, reduction or other charge.

- (d) The amounts set forth in this Section 22.4 shall be increased annually on July 1 of each year by a percentage equal to the percentage increase in the CPI Index between the CPI Index of the second (2nd) immediately preceding year and the CPI Index of the immediately preceding year (in no event shall the amount be less than the amount in effect during the immediately preceding year).
- (e) UMLLC shall be entitled to immediate and automatic liquidated damages from the Concessionaire equal to [twenty thousand dollars (\$20,000)] per day for each day that the IMP Substantial Completion Date is later than the Planned IMP Substantial Completion Date. Such liquidated damages shall constitute UMLLC's sole right to monetary damages for such delay.
- (f) UMLLC shall be entitled to immediate and automatic liquidated damages from the Concessionaire equal to [ten thousand dollars (\$10,000)] per day for each day that the IMP Final Acceptance Date is later than the IMP Final Acceptance Deadline. No liquidated damages shall be owing under this Section 22.4(f) for any day for which liquidated damages are owing under Section 22.4(e). Such liquidated damages shall constitute UMLLC's sole right to monetary damages for such delay.

[Signature page follows]

IN WITNESS WHEREOF, UMLLC and the Concessionaire have caused this Agreement to be signed by their respective officers thereunto duly authorized as of the date first written above.

Utilities Modernization LLC,
a Louisiana limited liability company

BY: _____
PRINTED: [•]
ITS: [•]

DRAFT

[•]

By: [•]

BY: _____

PRINTED:

ITS:

DRAFT

SCHEDULE 21
Notices to Proceed; Conditions to IMP Substantial Completion and IMP Final Acceptance
of Initial Modernization Project

PART 1 – NOTICES TO PROCEED

Section 1 NTP1 Conditions

(a) Approval by UMLLC of (i) the Final Design and (ii) the Approved Budgeted Amount with respect to the Initial Modernization Project pursuant to Section 4.3(f) of the Agreement;

(b) The D&C Security has been obtained (and copies thereof furnished to UMLLC) and is in full force and effect in accordance with Section 21.6 of the Agreement;

(c) [•]

Section 2 NTP2 Conditions

[•]

Section 3 NTP3 Conditions

[•]

PART 2 – IMP SUBSTANTIAL COMPLETION

1. COMPLETED D&C WORK

The Concessionaire has completed the D&C Work with respect to the Initial Modernization Project, including all SC Punch List items, in accordance with the approved Final Design, the D&C Closeout Plan, and the terms and conditions of this Agreement, except with respect to any FA Punch List items.

2. FUNCTIONAL UTILITY SYSTEM

- (a) The Utility System, as upgraded via the Initial Modernization Project, is fully operational and capable of being operated full-time, uninterrupted, and continuously in accordance with the [Final Design].
- (b) The Utility System, as upgraded via the Initial Modernization Project, meets the Performance Standards.
- (c) All ancillary items including equipment, supplies, spare parts and manuals are in place for the Utility System, as upgraded via the Initial Modernization Project.
- (d) The Concessionaire has updated the Operations Plan.
- (e) All establishment and commissioning procedures for the Utility System, as upgraded via the Initial Modernization Project, have been successfully completed in accordance with the testing and commissioning requirements set forth in [●].

3. INSURANCE

All Concessionaire Required Coverages required to be obtained under Section 13.1 (*Insurance Coverage Required – Concessionaire*) of the Agreement have been obtained and are in full force and effect in accordance with Section 13.1 (*Insurance Coverage Required – Concessionaire*) of the Agreement.

4. NO CONCESSIONAIRE DEFAULT

There exists no uncured Concessionaire Default that is the subject of a notice, unless the achievement of IMP Substantial Completion will effect its full and complete cure.

5. AUTHORIZATIONS

All Authorizations (if any) required to perform the Utility System Operations with respect to the Utility System, as upgraded via the Initial Modernization Project, are in place, have been provided to UMLLC, and are not subject to appeal.

6. FA PUNCH LIST

The Concessionaire and UMLLC shall have agreed the final FA Punch List.

7. PAYMENT OF THE UNEXPENDED CONTINGENCY AMOUNT

The Concessionaire shall have paid to the University the Unexpended Contingency Amount pursuant to Section 22.2(i).

PART 3 – IMP FINAL ACCEPTANCE

1. FA PUNCH LIST

The Concessionaire has achieved IMP Substantial Completion and completed all FA Punch List items in accordance with the approved Final Design, the D&C Closeout Plan, and the terms and conditions of this Agreement.

2. DEMOBILIZATION

All demobilization from the Property is complete, including the removal of temporary work and equipment used in the performance of the D&C Work, but not required for Utility System Operations.

3. NO CONCESSIONAIRE DEFAULT

There exists no uncured Concessionaire Default that is the subject of a notice, unless the achievement of IMP Final Acceptance will effect its full and complete cure.

4. RELEASE OF LIENS

The Concessionaire has provided evidence to UMLLC that all Contractors have waived any rights to liens against the Utility System and the Property.

5. INSURANCE

All Concessionaire Required Coverages required to be obtained under Section 13.1 (*Insurance Coverage Required – Concessionaire*) of the Agreement have been obtained and are in full force and effect in accordance with Section 13.1 (*Insurance Coverage Required – Concessionaire*) of the Agreement.

6. RECORD DRAWINGS

The Concessionaire has provided UMLLC with a complete set of [as-built drawings/final Construction Documents], in form and content required by [●].

7. PAYMENTS TO UMLLC

The Concessionaire has paid in full all [liquidated damages] arising or resulting from the D&C Work that are owing to UMLLC pursuant to the Agreement and are not in dispute.

DRAFT

SCHEDULE 2

PERFORMANCE STANDARDS

TABLE OF CONTENTS

Part I - GENERAL.....	1
Part II - PERFORMANCE STANDARDS – GENERAL OPERATIONS.....	3
1) General.....	3
2) Exterior Appearance of Utility Facilities.....	7
3) Utility Marking, GIS Mapping and Asset Management.....	7
4) Health and Safety.....	8
5) Emergency Response and Unplanned Outages.....	9
6) Procedures for Planned Outages.....	11
7) Design Standards.....	12
8) Material and Equipment Management.....	12
9) Personnel, Operations and Reporting.....	13
10) Environmental Compliance.....	15
11) Utility Office Functions.....	19
12) Interagency Cooperation and Coordination.....	20
13) University Department Office Cooperation.....	20
14) Public Relations and Media Interactions.....	21
15) Vehicle Use and Operation.....	21
16) Utility Service Inquiries.....	22
17) Safety Plans.....	23
18) Continuity Management Plan.....	23
19) Information Technology, Communications and Connectivity.....	24
Part III - PERFORMANCE STANDARDS – CHILLED WATER SYSTEM.....	27
1) Temperature Requirements.....	27
2) Pressure Requirements.....	27
3) Line of Demarcation between Concessionaire and University.....	27
4) Metering.....	27
5) Efficiency.....	28
6) Design Standards.....	28

7)	Unplanned Outage Notifications.....	29
8)	Redundancy.....	30
9)	Water Quality.....	31
Part IV - PERFORMANCE STANDARDS STEAM AND CONDENSATE SYSTEM		32
1)	Temperature Requirements.....	32
2)	Pressure Requirements.....	32
3)	Air Quality Permit with LDEQ.....	32
4)	Line of Demarcation between Concessionaire and University.....	32
5)	Metering.....	33
6)	Efficiency.....	34
7)	Design Standards	34
8)	Unplanned Outage	34
9)	Redundancy.....	36
10)	Energy Procurement.....	36
11)	Condensate water storage	37
Part V - PERFORMANCE STANDARDS – ELECTRIC SYSTEM		38
1)	Power Requirements	38
2)	Line of Demarcation; Concessionaire, University, and Electric Utility	38
3)	Metering.....	39
4)	Efficiency	40
5)	Design Standards	40
6)	Unplanned Outage	40
7)	Redundancy.....	41
8)	Distribution System Switching	42
Part VI - PERFORMANCE STANDARDS – UTILITY SCADA NETWORK SYSTEM.....		43
1)	Availability Requirements	43
2)	Line of Demarcation between Concessionaire and University.....	43
3)	Utility Network Components.....	43
4)	Unplanned Outage	44
5)	Redundancy.....	45

Part I - GENERAL

Introduction and Purpose of Performance Standards

These Performance Standards and any Appendices hereto are provided pursuant to Article 6 of the Long-Term Lease and Concession Agreement for the Louisiana State University Utility System (as modified, amended or restated, the "Concession Agreement") to which they are attached. These Performance Standards and the Appendices hereto are incorporated and made part of the obligations under the Concession Agreement.

The Utility System is comprised of 3 individual Utilities, specifically the: (i) the portion of the Utility System that generates, distributes and returns chilled water (the "Chilled Water System"); (ii) the portion of the Utility System that generates, distributes and returns steam, hot water, and condensate, which as of the date hereof is subject to Air Quality Tier I Operating Permit [●] (the "Steam and Condensate System"); and (iii) the portion of the Utility System that produces (to the extent applicable) and distributes electricity (the "Electric System").

The purpose of the Performance Standards is to: (A) provide the minimum general requirements for the operations and maintenance of the University's Utility System and provide standards governing Utility System Operations as required by the Concession Agreement, but are not inclusive of all of the Concessionaire's responsibilities; (B) aid in the development of an Operations Plan (as defined herein) to be developed annually by the Concessionaire for the Utility System; (C) incentivize the Concessionaire to minimize the time during which the Utility System experiences outages; and (D) ensure that the Utility System is operated and maintained in accordance with Prudent Industry Practices.

Terms used and not otherwise defined in these Performance Standards shall have the meanings ascribed to them in the Concession Agreement (and any other schedules attached thereto). Any approvals or consent required under these Performance Standards shall be governed by the procedure outlined in Section 1.15 of the Concession Agreement. Unless otherwise stated herein or in the Concession Agreement, any modification or change to the requirements set forth in these Performance Standards or the Appendices hereto, shall be governed by Section 6.3 of the Concession Agreement. Any references to a governmental entity, industry standard organization or University department shall include any successor to such entity, organization or department. Any references to "degrees" shall, unless otherwise specified herein, mean "degrees Fahrenheit." To the extent that any term or provision specified herein conflicts with any term or provision of the Concession Agreement, the Concession Agreement shall govern.

The Concessionaire shall perform all duties and tasks and all other responsibilities required by these Performance Standards in conformance with Prudent Industry Practices, and the Concessionaire shall keep the Utility System in good condition and repair throughout the Term of the Concession Agreement. If the Concessionaire fails to meet these Performance Standards, it shall be subject to the procedures in the Concession Agreement for addressing such failures.

If deficiencies or situations affecting minimum standards for performance develop during the Term that are not specifically noted herein, it is the Concessionaire's responsibility to correct the

deficiencies and manage such situations such that the Utility System will be maintained in the condition required by these Performance Standards.

DRAFT

Part II - PERFORMANCE STANDARDS – GENERAL OPERATIONS

1) General

- a) The Concessionaire shall propose a plan with respect to the Utility System in accordance with these Performance Standards and the Concession Agreement (the “Operations Plan”). The Operations Plan shall include and satisfy at a minimum, all requirements and all components of the Performance Standards and Prudent Industry Practices and shall include, in addition to the specific requirements set forth herein, the following: (1) the plan for the operation, repair, maintenance and replacement of the Utility Facilities and Utility System Assets; (2) any proposed or expected changes to the environmental permitting requirements or classifications of any portion of the Utility System for the upcoming 5 years, of which the Concessionaire has knowledge; (3) any proposed or expected requirements related to regulatory changes affecting the Utility System, of which the Concessionaire has knowledge; (4) the 1 year short term list of goals and expectations for the Utility System operations and 5 year list of strategic goals therefor as described in Section 1(d); (5) a detailed staffing plan, as described in Section 9(b); (6) the Safety Plans; (7) the Continuity Management Plan; (8) a maintenance management program, as described in Section 1(e); and, (9) operations and maintenance manuals for all Utility Facilities. The Concessionaire shall submit such Operations Plan to UMLLC for its review within [30] days after the date of the Concession Agreement and as further required herein. UMLLC will review the Operations Plan and where appropriate, will provide comments for Concessionaire’s consideration. The Concessionaire shall perform all components of the Operations Plan. The Operations Plan shall cover each Fiscal Year. The Operations Plan must include an appropriate 5-year cyclical maintenance and repair program/plan to provide a safe and satisfactory level of service and to maximize Utility System service life in accordance with these Performance Standards. To the extent that any term or provision of the Operations Plan conflicts with any term or provision of these Performance Standards, the Performance Standards shall govern.
- b) All operations, repairs, replacement and maintenance activities shall be carried out in a good and workmanlike manner so as to ensure continuous safety for users of the Utility System and to sustain the value of the Utility System as an asset. Condition assessments and inspections shall follow Prudent Industry Practices and recognized national standards as set forth herein. If UMLLC elects, at its sole cost and expense, to perform, or cause to be performed by a qualified engineering firm, any such assessment or inspection, then the Concessionaire covenants to address any failures to operate, repair or maintain the Utility System in accordance with these Performance Standards and the Concession Agreement, noted therein as promptly as reasonably practicable, and the Concessionaire shall reasonably cooperate with UMLLC and any qualified engineering firm engaged by UMLLC.
- c) Other than as set forth in Section 1(a) with respect to the first Operations Plan, the Concessionaire must update and submit its Operations Plan for the upcoming Fiscal Year to UMLLC no later than 120 days prior to the beginning of each Fiscal Year.

UMLLC will review and if necessary, comment on the Operations Plan. The Concessionaire shall submit an updated Operations Plan for the start of each Fiscal Year, which may be based on the prior Fiscal Year's Operations Plan. If the Concessionaire fails in its obligation to submit an Operations Plan by the commencement of such Fiscal Year, the Operations Plan for the preceding Fiscal Year shall remain in place until an updated Operations Plan is submitted, provided that such updated Operations Plan shall remain subject to UMLLC's right to review and comment as set forth above. Notwithstanding the above, any proposals subject to UMLLC Approval as part of the Concessionaire's Five Year Plan, must comply with Article 4 and Article 7 of the Concession Agreement.

- d) The Operations Plan shall specify how the Concessionaire has considered, trained personnel, addressed, and planned for all operational, repair, maintenance and replacement activities in connection with the Utility System and has established protocols, procedures, responsibilities, and minimum requirements to operate, repair, maintain and replace the Utility System in accordance with these Performance Standards, the Concession Agreement and Prudent Industry Practices. If UMLLC provides comments on the Operations Plan that are necessary for such Operations Plan to comply with these Performance Standards, the Concession Agreement or Prudent Industry Practices, then the Concessionaire shall implement such comments or provide some reasonable alternative that addresses the failure to comply with Performance Standards, the Concession Agreement or Prudent Industry Practices. The Operations Plan shall set out a list of goals (including strategic goals) for the Fiscal Year and the 5 Fiscal Years thereafter to indicate focus areas aligned with the above. The Operations Plan shall also include the Concessionaire's standard operating procedures for each Utility Facility in connection with its operation of the Utility System.
- e) As part of the Operations Plan, the Concessionaire shall include a maintenance management program for the Utility System. The maintenance management program shall, at a minimum, meet Prudent Industry Practices and shall include procedures and records for asset management that include critical equipment capacity identification/documentation, inspection and testing plans, PM and PdM (each as defined herein), maintenance workflow including work prioritization based on equipment criticality, planned outages, continuous improvement teams, and records management. Generally, the asset management program will be implemented in the current CMMS for the Utility System or utilize a maintenance management system of its own choosing, provided that the adoption of such system shall not qualify as a Capital Improvement. The Concessionaire shall indicate any major changes to the maintenance workflow in the prior Fiscal Year as well as planned improvements and/or changes aligned with provided goals in the Operations Plan.
- f) The Concessionaire shall maintain records related to its maintenance and operation of the Utility System in accordance with Section 3.12 of the Concession Agreement. The records regarding maintenance of the Utility System required to be retained by the Concessionaire shall include the following:

- i. Status of Utility System Assets with disposition of breakdowns, deteriorating conditions, failure to start, significant decrease in capacity or performance (> 5%);
 - ii. Any changes to the Utility System or Utility System Operations required or made due to environmental and regulatory changes required by Law or applicable Governmental Agency;
 - iii. One, three and six-year projection of life expectancies of equipment that would be considered Capital Improvements based upon maintenance performed and manufacturer's recommendations;
 - iv. State of Louisiana Certificate(s) and risk management for boilers;
 - v. Annual inspections required by the University Environmental Health and Safety Department or its successor department ("EHS") and documentation evidencing compliance with all applicable health and safety regulations; and
 - vi. The Preventive Maintenance (as defined herein) data specified in Section II 1(i) of these Performance Standards.
- g) The Concessionaire shall include in its Operations Plan a proposed plan for its expenditures to extend the useful life of any and all components of the Utility System, including planned replacements or any additions thereto. The proposed plan shall include any major system or specific equipment improvements planned for the next Fiscal Year, as well as indicate changes to existing environmental permitting requirements that may be needed to implement the improvements.
- h) Currently, maintenance activities are managed through [*insert system software name*]. The Concessionaire shall either continue to use such system for the Utility System and for any requests made pursuant to Section II 1(k) of these Performance Standards by the University or utilize a maintenance management system of its own choosing, provided that the adoption of such system not qualify as a Capital Improvement (a "CMMS").
- i) Maintenance Workflow
- i. The Concessionaire shall maintain an asset list with documented criticality in the CMMS.
 - ii. The Concessionaire shall train all personnel on utilization of the maintenance workflow described herein including work order generation, backlog reviews, work prioritization, outage management, schedule development, and work completion. The following defines the type of work orders:

1. “Corrective Maintenance” is defined as the specific maintenance actions performed on Utility System Assets or Utility Facilities (or a portion thereof), in the event that a Utility System Asset’s or a Utility Facility’s current condition is below the required standards as identified by a Preventive Maintenance, Predictive Maintenance (as defined herein), or technician observation.
 2. “Emergency Maintenance” is defined as the maintenance necessary to restore operation to equipment, systems, or components in the Utility System that have failed to operate as required.
- iii. The Concessionaire shall provide the Corrective Maintenance necessary to maintain the Utility System in good condition and repair and otherwise in accordance with Prudent Industry Practices.
 - iv. The Concessionaire shall perform all Emergency Maintenance as promptly as possible within time limits agreed to by the Parties and, if applicable, adhere to the Unplanned Outage (as defined herein) requirements set forth herein.
 - v. The Concessionaire shall develop or maintain Preventive Maintenance and Predictive Maintenance plans based on equipment criticality, in accordance with Prudent Industry Practices, including applicable operations and maintenance best practices industry manuals and shall include those plans in the Operations Plan.
 1. “Preventive Maintenance” or “PM” is defined as maintenance and/or inspections on a Utility System Asset or a Utility Facility or a portion thereof based on a pre-determined schedule or run time to reduce the probability of failure. A Corrective Maintenance work order shall be written to address any findings from a Preventive Maintenance task.
 2. “Predictive Maintenance” or “PdM” is defined as the tests performed on a Utility System Asset or a Utility Facility or a portion thereof to determine current condition and remaining life to reduce the probability of failure. A Corrective Maintenance work order shall be written to address any findings from a Predictive Maintenance task.
 - vi. The Concessionaire shall perform PM and PdM in accordance with the plans included in the Operations Plan. The Concessionaire shall keep records and track PM and PdM completion against planned schedules.
- j) In order to properly assist UMLLC in the comprehensive planning for, efficient management of, effective repair of, and controlled access to, the public ways on the University Campus and to lessen the public inconvenience of uncoordinated work in the Public Way while promoting the general public health, safety, and welfare,

the Concessionaire shall adhere to any University or municipality policies, including the Safety, Health and Environmental Policies attached as Appendix A (collectively, the “EHS Policies”), provided that, with respect to other University policies, the University has provided the Concessionaire with written notice thereof.

- k) Upon request of UMLLC, the Concessionaire shall perform such services for which the Concessionaire has a Concessionaire Charge Rate as requested by the University that are outside of the Utility Services and the Utility System Operations, in which case UMLLC shall pay to the Concessionaire the cost therefor by payment of the applicable Concessionaire Charge Rate within 30 Days after receipt of an invoice therefor.

2) **Exterior Appearance of Utility Facilities**

- a) The Concessionaire shall maintain the exterior appearance of Utility Facilities in accordance with the University’s design standards applicable to the University, provided in Appendix B, as may be updated from time to time (the “Design Standards”). Changes to the exterior appearances of Utility Facilities, including without limitation, the color and lighting of such Utility Facilities and any signage thereon, shall require prior Approval of UMLLC.

3) **Utility Marking, GIS Mapping and Asset Management**

- a) The Concessionaire shall provide utility marking of the Utility System in accordance with applicable Law and Prudent Industry Practices. The utility marking process shall include:
 - i. Support design activities during project planning and development;
 - ii. Provide pre-excavation marking for all construction and maintenance projects with 48-hours of notification;
 - iii. Provide line locating and elevation during installation of new equipment; and
 - iv. Contact “(X) (811)” for marking of buried Utility System distribution assets before commencing digging activity.
- b) The Concessionaire shall provide mapping updates to reflect modifications to the existing Geographic Information System (“GIS”) for the Utility System including mapping of all Utility System Assets that are abandoned and not removed during the Term. Such information and updates shall be provided in a format and include details as requested by UMLLC.
 - i. The Concessionaire shall reasonably cooperate with the University and UMLLC in connection with the GIS, which contains information regarding both Utility Facilities as well as other facilities which are not part of the

Utility System, in connection with any changes, updates or modifications to the Utility System.

- c) The Concessionaire shall be responsible for providing updates for the GIS to UMLLC and the University in a timely manner to accurately depict the state of the existing Utility System. Within 10 Business Days after any change to the state of the existing Utility System, the Concessionaire shall provide to UMLLC and the University the information necessary for the University to update the GIS for the Utility System due to any material change including addition, modification, repair, or abandonment of any portion of the Utility System. For purposes of providing updates for changes to the Utility System due to construction activities, a 'change' shall be deemed to occur when the improvement being constructed is deemed 'substantially complete' and or becomes actively employed in delivering Utility Services.
- d) The Concessionaire shall provide regular mapping update information to the University's team for the Utility System GIS (as designated by UMLLC to the Concessionaire), to include surface feature updates and repairs and non-material changes, every 6 months.

4) **Health and Safety**

- a) The Concessionaire shall develop and adhere to safety and security standards in performing Utility System Operations which standards, at a minimum, meet Prudent Industry Practices, applicable Law and EHS Policies. The Concessionaire shall develop and document policies and procedures to ensure the security and safety of the Utility System that, at a minimum, shall be consistent with Prudent Industry Practices and current emergency management policies or procedures provided in Appendix C (the "Facilities Emergency Management Plan") (See also Part II, Section 5(a)). Such policies and procedures shall be included or referenced in the Operations Plan. In addition, the electrical safety program shall be in compliance with all applicable Laws, including standards established by the United States Occupational Safety and Health Administration ("OSHA") as well as the National Fire Protection Association ("NFPA") (NFPA 70E), including applicable training and qualifications programs.
- b) The Concessionaire shall coordinate with the University's Department of Public Safety and local law enforcement, as appropriate.
- c) The Concessionaire shall secure the industrial control systems within the Utility System in accordance with Prudent Industry Practices and University policy then in effect.
- d) The Concessionaire shall promptly notify the University's Department of Public Safety and local law enforcement upon learning of suspected or alleged criminal activity concerning the Utility System.

- e) The Concessionaire shall abide by all regulations of the University's Department of Public Safety.
- f) The University's Department of Public Safety and EHS shall have access at all times (24 hours a day, 7 days a week) to all plants, buildings and any other Utility Facilities on the University Campus which are required to be maintained by the Concessionaire.
- g) The Concessionaire shall be responsible for ensuring that safety security alarms, including fire alarms which are part of the Utility System, are directly tied to the life and safety systems of the University.
- h) Except as otherwise provided in Concession Agreement, Concessionaire shall ensure that any and all cameras installed by Concessionaire in Utility Facilities shall provide a direct feed to the University's security office, use the University's network and meet the University's specifications for video surveillance as described in Appendix E.
- i) The University facilities are under the jurisdiction of the State Fire Marshall. Therefore, all Utility Facilities on the University Campus shall be subject to inspection by the State Fire Marshall, Environmental Health and Safety personnel, University Fire Protection personnel and the Department of Public Safety.
- j) The Concessionaire shall adhere to any and all applicable policies, practices and procedures set forth by the University, including the EHS Policies.
- k) As part of the Concessionaire's obligation to comply with all Laws, the Concessionaire shall comply with all OSHA requirements, including without limitation, documented safety training programs and injury reporting and logs.
- l) The Concessionaire and the Operator are required to maintain commercial and appropriate drug testing in accordance with all applicable Laws, including the requirements of the US Department of Transportation.

5) **Emergency Response and Unplanned Outages**

- a) The Concessionaire shall follow the current Facilities Emergency Management Plan in the event of an Emergency or other event described therein.
- b) The Concessionaire shall provide personnel to support all procedures and activities required by the University during an Emergency and or failure of the Utility System or any portion thereof which failure had not previously been approved by the University (each, an "Unplanned Outage"), as described in more detail for each Utility as set forth in Parts III through VI hereof, in order to provide the required Utility Services.
- c) During an Unplanned Outage, the Concessionaire shall work cooperatively with UMLLC until Utility Services are restored. During any Unplanned Outage, the

Concessionaire shall follow all communication procedures for an Emergency and all applicable Emergency response plans provided by the University, including working with a representative contact designated by the University's Assistant Vice President for Facilities (the "Communications Contact"). The Concessionaire shall provide status updates as soon as possible after any Emergency or Unplanned Outage to the Facilities Maintenance Front Desk to any designated University contacts using the communication medium designated by the University.

- d) The Concessionaire shall adhere to the procedures and requirements for an Unplanned Outage set forth in these Performance Standards for each individual component of the Utility System.
- e) The Concessionaire shall designate a representative to participate in the University's Critical Incident Management Team (the "CIMT"), which representative shall:
 - i. Attend meetings at the reasonable request of the University or UMLLC;
 - ii. Obtain training required by the University or UMLLC; and
 - iii. Assist in coordination with the University and UMLLC to respond during Emergencies.
- f) During any Unplanned Outage, the Concessionaire shall send prompt updates to the CIMT and the designated Communications Contact, if activated, in addition to the procedures and requirements for an Unplanned Outage set forth in these Performance Standards for each individual component of the Utility System.
- g) At least 48 hours before (i) any visit by a head of state or political dignitary, (ii) any significant political event, (iii) any home football game, (iv) move-in week for fall semester on the University Campus, (v) finals week for fall semester and spring semester for the University Campus (the exact dates of which shall be available on the University's website), (vi) graduation ceremonies or (vii) any other event which the University provides advance written notice of to the Concessionaire (each, a "Major Event"), the Concessionaire shall:
 - i. Prepare a response plan for an Unplanned Outage, in accordance with the University's then-existing mechanical and Electric System access and response practices and the Facilities Emergency Management Plan and promptly implement such plan as necessary; and
 - ii. Provide a subject matter expert as a resource to the University's Strategic Communications Department and the CIMT before and during such Major Event.
- h) If Concessionaire is not provided with advance notice of a Major Event sufficient to comply with the deadline set forth in Section 5(g), above, the Concessionaire shall provide the listed information as soon as practicable following notification of

any Major Event. If a Major Event recurs during a Fiscal Year, e.g., home football games, then the Concessionaire's responsibility shall be to provide such response plans and the subject matter expert for those Major Events, as a group, and the Concessionaire shall not be responsible for submitting separate information for each such Major Event within that group, unless the University or UMLLC so requests.

- i) In the event an Unplanned Outage impacts the University Campus, the Concessionaire shall, at the University's request, provide a subject matter expert as a resource to the University's Strategic Communications Department for the duration of the need arising from the Unplanned Outage.
- j) Promptly following any Unplanned Outage, and in any event within 15 Business Days thereafter, the Concessionaire shall provide to UMLLC a report on such Unplanned Outage, which shall include a reasonably detailed summary of the Unplanned Outage, including the apparent cause, and the corrective actions taken with respect thereto. As soon as reasonably practical thereafter, but in any event within 60 Days after the Unplanned Outage, the Concessionaire shall provide UMLLC with a root cause analysis of the Unplanned Outage and any recommended changes in operations or Capital Improvements that the Concessionaire recommends to prevent future, similar Unplanned Outages.
- k) The Concessionaire shall notify the Facilities Maintenance Front Desk as soon as reasonably practicable by calling [number] (the "University Front Desk Number") in the event of an Unplanned Outage.

6) **Procedures for Planned Outages**

- a) The Concessionaire shall develop and follow plans and procedures for communicating a planned outage of the Utility System (a "Planned Outage") in a form and manner reasonably acceptable to UMLLC. Failure to adhere to such requirements shall cause any outage of any part of the Utility System to be deemed an Unplanned Outage. In addition to the requirements set forth above, the Concessionaire shall provide notice of such Planned Outage at least 30 Business Days before the Planned Outage.
- b) Prior to a Planned Outage, the Concessionaire shall consult with the University and UMLLC to determine when temporary utility sources (such as electrical generators, boilers or chillers) are necessary to maintain building operations, and the Concessionaire shall provide such temporary utility sources as agreed with the University and UMLLC.
- c) The Concessionaire shall coordinate the restoration of Utility Services following a Planned Outage with the University and UMLLC.

7) **Design Standards¹**

- a) The Concessionaire shall follow the Design Standards for all portions of the Utility System, unless (i) otherwise provided for herein, (ii) the Utility System does not, as of the Turnover Date, comply with the Design Standards and then only with respect to such non-compliance or (iii) Approved by UMLLC, provided that UMLLC shall be reasonable in granting its Approval to a deviation from the Design Standards that is consistent with other deviations to the Design Standards then-existing with respect to the Utility System. The Concessionaire shall develop and document design standards for the Utility System or deviations from the existing Design Standards and shall submit them for Approval to UMLLC within 1 Year after the Turnover Date. UMLLC shall review such proposal and respond, either approving or disapproving such submission within 60 Days after receipt thereof. If UMLLC so disapproves, it shall provide a reasonably detailed explanation as to the reasons therefor, and the Concessionaire shall resubmit a revised submission addressing such reasons. Once such submission (or re-submission) is Approved by UMLLC, it shall be included in the Design Standards and apply to the Utility System. Future changes to those Design Standards for the Utility System shall be Approved by UMLLC before adoption.
- b) UMLLC retains the right to modify or update the Design Standards or (to the extent that such Design Standards relate to the Utility System) direct the Concessionaire to do so, which modification or update shall be deemed a modification of these Performance Standards under Section 6.3(a) of the Concession Agreement. The Concessionaire shall participate in and provide input on periodic updates to the Design Standards and shall provide proposed changes if requested by the University or UMLLC.

8) **Material and Equipment Management**

- a) The Concessionaire shall procure all necessary equipment and materials to properly operate the Utility System. Such equipment and material shall be appropriate for its use and, at a minimum, meet Prudent Industry Practices.
- b) The Concessionaire shall include in its Operations Plan its plan for materials management; which shall include:
 - i. A process for procuring materials for the operation of the Utility System;
 - ii. A process for maintaining adequate inventory levels to account for Planned Outages and Unplanned Outages;
 - iii. A plan for maintenance of the Concessionaire's storage facilities;

¹ NOTE TO DRAFT: Parties to discuss coordination of this provision with requirements for delivery of the Initial Modernization Project.

- iv. A method for staging materials; and
 - v. Minimum levels of certain materials identified as critical by the Concessionaire, below which the Concessionaire shall reorder such materials.
- c) In all events, the Concessionaire shall purchase materials and equipment for use in the Utility System that are:
- i. Fit and serviceable for the intended purpose and free of defects;
 - ii. UL-listed, if applicable at the time of purchase;
 - iii. Of the type and quality typically used in Comparable Utility Systems.
- 9) **Personnel, Operations and Reporting**
- a) Whenever the Concessionaire is required to utilize a qualified engineer, such engineer shall be subject to the UMLLC's prior Approval. The Concessionaire shall have the right to provide a list of qualified engineers to UMLLC on an annual basis for the UMLLC's approval in accordance with Louisiana Code. The Concessionaire shall then be permitted to utilize any engineer on such list.
- b) As part of its Operations Plan, the Concessionaire shall provide a high-level staffing plan, which shall include, at a minimum:
- i. Organizational chart(s);
 - ii. Any changes to shift planning for normal operations;
 - iii. Emergency response staffing and communications contact who is designated to work with the University (the "Concessionaire Communications Contact");
 - iv. New position descriptions;
 - v. Screenings / testing, which the Concessionaire shall provide to the University promptly after receipt thereof;
 - vi. High-level training and employee development plan;
 - vii. Employee credentials, licenses and other certifications;
 - viii. Diversity and inclusion;
 - ix. Rates of pay;
 - x. Overtime policies and practices for all employees; and

- xi. One year and five-year plans for staffing level increases or decreases, including organizational charts indicating the areas of staff addition or reduction.

- c) As part of its Operations Plan, the Concessionaire shall include a plan for providing personnel coverage during an Emergency, for both a short-term and long-term closure of the University. Such plan shall include a list of employees designated as serving in “essential,” “alternate,” or “standby” status during an Emergency, and identify the Concessionaire Communications Contact, for both short-term and long-term closures. The Concessionaire’s Emergency staffing and designations shall conform with then-current University policies for Emergency preparedness and for short-term and long-term closures.

- d) Within 10 days after the end of each month, the Concessionaire shall provide monthly plant data as outlined in the KPIs and as otherwise required by the Concession Agreement (including, without limitation, these Performance Standards).

- e) As part of the monthly meeting process documented in Schedule 15 of the Concession Agreement, the Concessionaire shall promptly provide information to UMLLC regarding the operations of the Utility System, including:
 - i. The results of the chemical, water treatment, and pre-treatment plans;
 - ii. Environmental and regulatory compliance;
 - iii. The implementation of safety programs;
 - iv. The effectiveness of utility data systems and IT network security;
 - v. Plant operating procedures;
 - vi. Peak Utility System loads and percentage of installed capacity; and
 - vii. Utility System operating efficiency metrics as outlined in Appendix G.
 - viii. Status of equipment to ensure N+1 redundancy.

- f) The Concessionaire shall support project design reviews with the University Architectural and Engineering Services for University Campus projects requiring utility services support and new utility connection planning, design and construction inspections.

- g) The Concessionaire shall plan and execute hot work and energized electrical equipment testing with respect to the Electric System per applicable safety standards including NFPA 70E.

- h) The Concessionaire shall develop and conduct electrical power system studies including load demand, short circuit, electrical coordination, and OSHA arc flash utilizing SKM software (or equivalent) and in compliance with all applicable IEEE standards. The Concessionaire will maintain University Campus SKM (or equivalent) arc flash modeling, incorporating facility and building studies as they are conducted and made available by the University (associated with the Main Plant and Highland Plants electrical infrastructure). The Concessionaire will provide utility point of interconnection fault current data to the University promptly after receipt of written notice from the University.
- i) The Concessionaire shall maintain Pipe-Flo and load models at or above the level existing as of the Turnover Date or develop mutually acceptable alternative models for the steam portion of the Steam and Condensate System that is designed for pressures of at least 120 psi and the Chilled Water System.
- j) The Concessionaire shall comply with the Utility Service Connection and Inspection Standards provided in the Design Standards.

10) **Environmental Compliance**

- a) In operating the Utility System, the Concessionaire shall comply with applicable Environmental Laws, all Authorizations related thereto (including all Campus-Wide Permits), EHS Policies, and any and all environmental or sustainability standards, policies or procedures adopted by the University and communicated to the Concessionaire.
- b) The Concessionaire shall instruct its employees and employees of the Operator to conduct all operation, repair, maintenance and replacement work in a manner so as to minimize exposure to Hazardous Substances. The Concessionaire shall notify the University of any planned activity that may disturb building materials containing Hazardous Substances and may require special handling pursuant to applicable Environmental Laws. If advance notice is not practicable, the Concessionaire shall notify the Facilities Maintenance Front Desk as soon as reasonably practicable by calling the University Front Desk Number after encountering building materials containing Hazardous Substances on or in the vicinity of the Utility System, and shall immediately cease any activity which would disturb or further disturb hazardous building materials until after Concessionaire has notified and consulted with the University regarding proper handling of such material. If the Concessionaire, in the course of its operation, repair, maintenance or replacement activities, creates a hazardous condition by disturbing or otherwise altering building materials containing Hazardous Substances, the Concessionaire shall manage such Hazardous Substances in accordance with all applicable Environmental Laws and in compliance with all University policies and programs including the EHS Policies and the Asbestos Management Program set forth in Appendix F.

- c) If the Concessionaire encounters or disturbs any Hazardous Substances in the course of its operations for which the University has retained liability pursuant to Section 3.2(d) of the Concession Agreement, the Concessionaire shall notify UMLLC in writing and shall also contact the Facilities Maintenance Front Desk and shall work with the University to facilitate any University action deemed necessary to comply with applicable Environmental Laws. In any case, the Concessionaire shall take measures to avoid causing, exacerbating, or contributing to any hazardous condition or any Release of a Hazardous Material encountered in the course of its operations. Further, whenever the Concessionaire becomes aware of any Release of any quantity of a Hazardous Substance, the Concessionaire must notify immediately UMLLC and comply with the notice requirements set forth in Section 8.1(b) of the Concession Agreement.
- d) The Concessionaire shall be responsible, at its sole cost and expense, for managing and remediating Hazardous Substances Released or encountered in the course of operations of the Utility System, in accordance with all applicable Environmental Laws but only to the extent that such are not otherwise considered to be excluded from liabilities and obligations of the Concessionaire pursuant to Section 3.2(d) of the Concession Agreement. The Concessionaire shall notify and coordinate with EHS before taking any non-emergency action to address a Release of a Hazardous Substance and shall include the University in any correspondence with regulatory officials regarding the management and remediation of the Hazardous Substances. If the University becomes aware of any Release or presence of Hazardous Substances in the Storm Water System, it shall promptly notify the Concessionaire, and the Concessionaire shall remediate such Hazardous Materials in accordance herewith.
- e) In addition to the obligations set forth in Section 11.13 of the Concession Agreement pertaining to the Campus-Wide Permits, the Concessionaire shall be responsible for coordinating with EHS for the completion of and filing all environmental reports and for environmental recordkeeping and monitoring pertaining to the operation of the Utility System as required by the University or UMLLC or as may be required under applicable Environmental Laws. In connection therewith, the Concessionaire shall provide immediately a copy of any report or communication submitted to a Governmental Authority by the Concessionaire or the Operator with respect to the Utility System related to Hazardous Substances or Environmental Laws.
- f) As part of its obligations under Section 3.12(a) of the Concession Agreement, the Concessionaire shall provide all necessary related operational and environmental data to the University for inclusion in campus-wide regulatory environmental reports and required records.
- g) The Concessionaire shall coordinate with the University, including EHS, regarding the development and implementation of the following plans/programs as required by applicable Environmental Laws:

- i. Spill Prevention Control, and Countermeasure Plan (“SPCC Plan”);
 - ii. Storm water management plan which complies with applicable National Pollutant Discharge Elimination System rules and University requirements, including the University’s Municipal Separate Storm Sewer System (MS4) permit;
 - iii. Petroleum storage and tank management program including inspections; and
 - iv. Refrigerant leak monitoring, reporting, and corrective action.
- h) The Concessionaire must certify annual compliance to UMLLC by certifying at least to the following on September 30 of each year:
- i. Certified recovery or recycling machines are used prior to disposal of appliances, except for MVACs and MVAC-like appliances. Certifications of machines are maintained on-site and available for review.
 - ii. Certified recovery or recycling machines are used when maintaining, servicing, or repairing appliances, except for MVACs. Certifications of machines are maintained on-site for review.
 - iii. Certified technicians verify that the applicable level of evacuation has been reached prior to opening.
 - iv. Records are maintained on-site for review showing compliance with the less than 15 or 35 percent loss of refrigerant within a 12-month period for appliances containing more than 50 pounds of refrigerant.
 - v. Certification of training for technicians is maintained on-site for review.
 - vi. Technician certification is provided to the wholesaler when purchasing Class I or Class II refrigerants.
 - vii. Service records are kept for appliances containing more than 50 pounds of refrigerant and are maintained on-site for review.
 - viii. All records shall be maintained at the refrigeration shop and accessible for inspection by UMLLC and Department of Environmental Quality or its successor agency (“Louisiana DEQ”).
- i) Hazardous Substances
- i. The Concessionaire shall not be allowed to use, dispose, treat or store any Hazardous Substances, other than those used in its ordinary course of operations, without written consent by the University.

- ii. The Concessionaire shall manage all wastes resulting from its operations in accordance with EHS Policies and applicable Environmental Laws. All applications, certifications and notifications required for the generation, storage and disposal of Hazardous Substances shall be provided to UMLLC at least 10 Business Days in advance of their submission, and the Concessionaire shall, in good faith, discuss with UMLLC any proposed changes thereto.
- j) Wastewater
 - i. Industrial discharge from operation of the Utility System shall meet the requirements of all Laws, including Environmental Laws and any directives provided by Governmental Authorities.
 - ii. Wastewater discharge permits and wastewater discharge operating requirements shall be coordinated with the University
- k) The Concessionaire shall be responsible for evaluation, recycling and/or disposing of waste generated in the course of Utility System Operations, in compliance with applicable Environmental Laws and in alignment with University policies. The Concessionaire shall collaborate in good faith with EHS in determining the foregoing.
- l) Environmental Emergency
 - i. In the event that the Concessionaire has become aware of a Release of Hazardous Substances into the environment due to Utility System Operations, the Concessionaire shall immediately notify UMLLC and the appropriate Governmental Authority in accordance with applicable Laws and applicable University policy.
 - ii. The Concessionaire shall also take immediate steps to remediate any release of Hazardous Substances and to minimize further Release of Hazardous Substances into the environment.
- m) Construction in Flood Plain. Concessionaire shall be responsible for obtaining (on its own behalf or on behalf of the University, as applicable) any required Flood Plain Permits from the US Army Corps of Engineers and Louisiana Department of Environmental Quality (LDEQ) via the Joint Application process for the Utility System (including any Capital Improvements or Material Changes) and the Utility Facilities, and shall adhere to all requirements from permits issued by those authorities. The Concessionaire shall reasonably cooperate with UMLLC for obtaining any required Flood Plain Permits from the US Army Corps of Engineers and LDEQ via the Joint Application process for property outside of the Utility System and the Utility Facilities (or involving a combination of property within and outside the Utility System and the Utility Facilities).

- n) Chemical Inventory. The Concessionaire shall be responsible for complying with the Resources Conservation and Recovery Act (RCRA) and the Emergency Planning and Community Right-to-Know Act (EPCRA) with respect to the Utility System Operations and the Utility System including all relevant chemical inventories and reporting requirements. Furthermore, the Concessionaire shall comply with the University's Hazard Communication Program attached hereto as part of the Safety Health and Environment Policy in Appendix A.
- o) Permits to Construct. If the Concessionaire undertakes any work that requires a permit to construct application to the LDEQ and/or the State Department of Health, it shall provide UMLLC all required materials to be submitted with respect thereto, including any application fees (the cost of which are Capped O&M Costs), and UMLLC shall have the right to review and Approve or disapprove such application within 10 Business Days. If Approved, UMLLC shall submit such application.
- p) If in connection with any Authorizations, including the Campus-Wide Permits, any fees or charges are incurred with respect to the Utility System or the Utility System Operations, the Concessionaire shall pay such amounts to UMLLC within 10 Business Days after request, and the cost thereof may be considered a Capped O&M Cost. With respect to the Title V Permit, the Concessionaire shall pay the annual emission inventory fees as calculated by the EHS and Louisiana DEQ officials. The Concessionaire shall provide the responsible official from UMLLC with all information pertaining to the annual emissions inventory. Notwithstanding the foregoing, to the extent that any fee, charge, penalty or other amount is payable in connection with any Authorization due to a failure to comply with a specified limit or other condition of such Authorization, the Concessionaire shall only be liable to pay a portion of such amount to the extent that its actions contributed to such failure.
- q) Underground Storage Tanks. Neither the Concessionaire nor the Operator will install any underground storage tanks on the Utility System Land or anywhere on the University Campus
- r) Aboveground Storage Tanks. Neither the Concessionaire nor the Operator will install any aboveground storage tanks on the Utility System Land or anywhere on the University Campus without the approval of the University's Department of Environmental Health and Safety

11) **Utility Office Functions**

The Concessionaire shall establish an office of the Utility System (the "Utility Office"), which shall be staffed by the Utility System Operator personnel and shall have a head of the Utility Office which shall serve as the lead of the Utility Office. The Utility Office is the primary point of contact for UMLLC regarding information on the Utility System and Utility System Operations, including Planned Outages, Unplanned Outages, general campus information and event-specific information related to the Utility Facilities and Utility Services.

12) **Interagency Cooperation and Coordination**

- a) The Concessionaire is required to cooperate with any and all local, state and federal governmental, regulatory and law enforcement agencies. As part of such cooperation, the Concessionaire shall expect, and reasonably accommodate, planned and unplanned inspections by applicable local, state and federal officials.
- b) The Concessionaire's required cooperation may include, but not be limited to:
 - i. Providing access to the Utility Facilities;
 - ii. Closing Utility Facilities for public safety purposes;
 - iii. Disconnecting Utility Services or a portion thereof due to an Emergency or law enforcement situation;
 - iv. Providing access to information contained in any surveillance system;
 - v. Attending planning and operational meetings;
 - vi. Providing a representative in the CIMT in the event of a large-scale or critical situation that involves any aspect of the Utility Facilities or the Concessionaire's responsibilities; or
 - vii. Any other action that is deemed necessary to ensure public safety.

13) **University Department Office Cooperation**

- a) The Concessionaire will work collaboratively with departments, offices or other entities of UMLLC for efficient, safe and effective Utility System Operations pursuant to the Concession Agreement and these Performance Standards or as may reasonably requested from time to time by the University.
- b) The Concessionaire's involvement with these departments as it relates to the Utility System may include, but not be limited to:
 - i. Participation in appropriate campus planning meetings including working with UMLLC to coordinate responses to media or other inquiries;
 - ii. Coordination of information and logistical activities to ensure customer utility needs are met;
 - iii. Coordination between Concessionaire construction projects and other construction activities being conducted by the University;
 - iv. Participation on work teams to plan impacts under numerous scenarios related to planned and unplanned events;
 - v. Campus Emergency coordination;

- vi. On- and off-campus construction; and
- vii. Working with University stakeholders to execute plans.

14) **Public Relations and Media Interactions**

- a) The Concessionaire shall have procedures in place for working with UMLLC and also for interacting with the University community, to the extent requested by the University. All communications about the Utility System directed to the University Campus constituents, or other University stakeholders must be coordinated with and Approved by UMLLC. The Concessionaire shall work with the designated University Communications Contact.
- b) The Concessionaire shall work with the University administration to engage the University community and media before, during and after any material event impacting or involving the Utility System or Utility Service, which plan shall be implemented following Approval by UMLLC.
- c) The Concessionaire may be contacted by members of the University community and media regarding information pertaining to the Utility System or Utility Service, and the Concessionaire shall, at UMLLC's option, either provide a referral to the appropriate entity (which may include a designated University representative) or a knowledgeable individual to respond directly to the University community and media. UMLLC reserves the right to take any and all action necessary to ensure effective communication.

15) **Vehicle Use and Operation**

The Concessionaire will be permitted to utilize service vehicles to facilitate the operations of the Utility System. The Concessionaire shall cause all of the operators of those vehicles to be trained in accordance with any applicable state and local requirements. In addition, because the Concessionaire's service vehicles will also represent the image and character of the University, the following guidelines must be followed for the use of service vehicles:

- a) The Concessionaire must ensure such service vehicles are in good operating condition and must maintain a sufficient inventory of service vehicles to meet the obligations of the Concessionaire at all times.
- b) The Concessionaire shall be responsible for ensuring the safe operation of all service vehicles.
- c) Insurance must be secured and maintained in accordance with the Concession Agreement.
- d) All service vehicles utilized by the Concessionaire must be clean, safe and regularly maintained to ensure safe operation.

- e) The vehicle body must be relatively free from damage. If damage occurs, it must be repaired within a reasonable period of time.
- f) Annual safety inspections must be performed and documented.
- g) All vehicles in use must have a cumulative fleet MPG average which meets applicable Federal fuel-efficiency standards, and must otherwise comply with all Laws and applicable University sustainability standards.
- h) All service vehicles will be clearly identified and bear uniform markings on both sides of the vehicle. These include, but are not limited to:
 - i. Company name; and
 - ii. Vehicle (fleet) number located on the rear of each vehicle.
- i) The Concessionaire shall develop and implement service vehicle user requirements and procedures including, but not limited to, the following:
 - i. Employees must be properly trained on proper and safe use of service vehicles;
 - ii. The Concessionaire must provide standards and procedures for screening service vehicle drivers and maintaining driver records;
 - iii. Service vehicle operators shall not permit unauthorized passengers to utilize the service vehicles at any time; and
 - iv. The Concessionaire shall report all service vehicle accidents on University property to UMLLC within one (1) Business Day following any accident.
- j) Service vehicles are subject to all University parking regulations and procedures.
- k) Service vehicles shall be licensed and authorized to use public roads.

16) **Utility Service Inquiries**

- a) The Concessionaire shall establish and implement a process for recording in the CMMS any University questions and comments about Utility System Operations and Utility Services (“Service Inquiries”). Service Inquiries shall be recorded as they are received. The Concessionaire shall maintain a record of Service Inquiries which shall include:
 - i. Specific Utility Service referred to in each Service Inquiry;
 - ii. Details of the Service Inquiry;
 - iii. A description of actions taken by the Concessionaire in response to the Service Inquiry, including corresponding date of actions taken; and

- iv. Details of how the Service Inquiry was resolved.
- b) The database of Service Inquiries shall be provided to UMLLC upon request.
- c) The Concessionaire shall respond to all non-outage related Service Inquiries within one (1) Business Day of receipt thereof and shall resolve all Service Inquiries in a timely manner.
- d) The Concessionaire must accept and respond to University Service Inquiries and outage reports on a 24-hour basis.

17) **Safety Plans**

- a) As part of its Operations Plan, the Concessionaire shall include a Fire Safety Plan, Evacuation Plan and Building Emergency Action Plan (collectively, “Safety Plans”) for the emergency response for Utility Facilities in the event of an Emergency that permits staff to quickly and safely evacuate each Utility Facility or take other applicable emergency measures to protect life and property. The Safety Plans must be in the same format as all other University building emergency action plans and include, in at least one of the Safety Plans, at a minimum, the following:
 - i. Evacuation procedures and roles;
 - ii. Evacuation routes;
 - iii. Shelter-in-place location(s);
 - iv. Emergency communications;
 - v. Training and drill schedules; and
 - vi. Emergency Utility Facility contact.
- b) The Safety Plans will be created in conjunction with the CM Plan, as defined below. The Safety Plans shall be submitted to UMLLC for the UMLLC’s comment, but UMLLC approval is not required. These plans must be evaluated on an annual basis and updated as needed. The Concessionaire shall make personnel and other resources available to conduct fire drills, Emergency drills or Emergency planning required by UMLLC as requested.
- c) The personnel training program shall include training on all Emergency activities and procedures required by Law. Documentation of enrollment and satisfactory completion shall be supplied to UMLLC and updated at least annually.

18) **Continuity Management Plan**

- a) As part of the Operations Plan, the Concessionaire shall include a Continuity Management Plan (“CM Plan”) to establish procedures and protocols in relation to

continuing or recovering services following an Emergency. This CM Plan must include, at a minimum, the following:

- i. Plan overview, scope, and assumptions document;
 - ii. Response teams with named individuals assigned to each team;
 - iii. An initial call tree;
 - iv. Contact information for key team members, vendors, departments, agencies, and university stakeholders;
 - v. Initial response activities in the following categories: command/leadership, communications, HR/employee care, financials, IT, and assessment;
 - vi. A list of all Utility Services, prioritized in order of recovery, with recovery time objectives assigned to each;
 - vii. One named individual as the contact in charge of recovery and one as an alternate contact for each service;
 - viii. A description of how each service will be continued or recovered in each of the following three scenarios:
 1. Unavailability of majority of staff;
 2. Unavailability of key applications and/or equipment;
 3. Unavailability of the building/Utility Facility;
 - ix. List of minimally-required resources for recovery;
- b) This CM Plan will be created in conjunction with the Safety Plans. The Concessionaire must evaluate the CM Plan on at least an annual basis and update the CM Plan as needed.

19) **Information Technology, Communications and Connectivity**

- a) The Concessionaire shall work with the Division of Information Technology, Information Technology Services (“ITS”) to develop and implement appropriate interconnection protocols and security measures whenever the Concessionaire is connecting to any electronic network, communications system or other electronic media owned, operated or managed by UMLLC or its agents.
- b) The Concessionaire understands that the University network is not certified for life-safety levels of availability that the University network will not be available during planned or unplanned maintenance events and that repairs on peripheral portions of the University network are handled on a commercially reasonable efforts basis.

- c) Prior to connecting to or using the University's electronic network, communications system or other electronic media, Concessionaire shall submit to the ITS for review, and approval all of the Concessionaire's electronic network security protocols, application security protocols, data storage protocols, access management procedures, and any other information that ITS determines necessary to protect the integrity and security of the University's electronic systems and communications networks.
- d) Any use of the University's electronic network, networking equipment, network closets, fiber infrastructure, copper infrastructure or other information systems shall be done with the approval of ITS and in compliance with current ITS policies and standards .
- e) The Concessionaire understands that the University cannot share network equipment (including without limitation, switches, routers and firewalls) nor infrastructure services (including without limitation, DHCP, DNS, IPAM, AAA services and network access control).
- f) The Concessionaire hereby designates the following individuals: [_____] ² to respond in a timely fashion to any and all security incidents, including copyright complaints, on connectivity provided through University-provide IP addresses.
- g) UMLLC shall, except as set forth herein, retain responsibility for installing and maintaining the University's fiber network; provided, the Concessionaire shall be responsible for for maintaining the portion of the University's fiber network that is exclusive and unique to the Utility System, to which the University hereby grants the Concessionaire a license to access, operate and maintain, and shall have the right to modify or add on to such portion of the University's fiber network with the University's Approval. The Concessionaire may lease fiber(s) or wired communications from the University, subject to agreement by the University, and shall have a non-exclusive right to use portions of the University's fiber network that had been used in Utility System Operations on a non-exclusive basis with other operations of the University prior to the Turnover Date. The University shall provide such optical fiber and/or wired communications to the Concessionaire at the cost normally charged by ITS to internal University customers, if available, or at the then-current average market rate charged by local providers of materially similar services.
- h) Any networks installed and maintained by Concessionaire as part of the Utility System must be built according to industry best practices including NERC CIP or other then-current standards as Approved by the University.
- i) Subject to the terms of the Concession Agreement and except as caused by the University's negligence or willful misconduct, Concessionaire assumes all risk and agrees to indemnify, defend and hold harmless the University from any and all

² NTD: Concessionaire to provide.

actions, claims, costs, demands, or suits arising out of or resulting from the Concessionaire's connection to or use of any electronic network, communications system or other electronic media owned, operated or managed by the University or its agents.

- j) Prior to deploying or using any wireless communications within the geographic boundaries of the University, Concessionaire shall submit to ITS for review, approval and acceptance, a detailed description of the Concessionaire's proposed wireless communications technology and any other information that ITS determines necessary. If required by ITS, the Concessionaire will implement all reasonable measures necessary (including abatement) to protect the integrity and security of current wireless communications networks and other equipment operating at the University.
- k) Conditions and requirements for Concessionaire's use for all wired network (IP), dark fiber, cellular data, analog telephone, or 802.11 WiFi communications systems on the University Campus, including service-level agreements, security protocols and operating standards for such use are set forth in Appendix J.

Part III - PERFORMANCE STANDARDS – CHILLED WATER SYSTEM

1) Temperature Requirements

- a) The Concessionaire shall ensure that the supply temperature of all chilled water being supplied by the portion of the Chilled Water System within [_____] on the University Campus must be between 42 and 46 degrees. The return temperatures must be between 57 and 65 degrees.
- b) The monitoring points to determine compliance with such requirements are set forth on Appendix H.

2) Pressure Requirements

- a) The Concessionaire shall ensure that the water being distributed by the Chilled Water System maintains pressure as required to maintain building chilled water interface valves in a general range between 20% and 90% open for normal operations that allows for flow control (provided that for any building on the University Campus that operates directly from Chilled Water System pressure, building chilled water interface valves may be up to 100% open).
- b) The Concessionaire shall maintain a minimum differential pressure that is measured at the Albertson's building must be maintained at a 14 psi differential (pressure difference between supply and return).
- c) The monitoring points to determine compliance with such requirements are set forth on Appendix H.

3) Line of Demarcation between Concessionaire and University

The line of demarcation for Chilled Water System is each exterior wall of the Utility Facility providing Chilled Water, as further described on Appendix L-1.

4) Metering

- a) The Concessionaire shall maintain, operate and replace plant and system meters in accordance with the requirements outlined herein.
 - i. The Concessionaire shall ensure the meters are accurate and calibrated to the manufacturer's recommendations.
- b) As part of the Operations Plan, the Concessionaire shall include a plan to ensure metering accuracy and a metering accountability metric for such meters that are part of the systems being maintained, improved, and operated. For the avoidance of doubt, the Concessionaire shall adhere to all applicable requirements with respect to all meters required to support the evaluation of adherence with KPIs and metrics and the monthly plant reconciliation process.

- c) The Concessionaire shall acquire, monitor and maintain Utility consumption data within the Utility System using metering software of its choosing, subject to the Approval of such software in the Five-Year Plan by the University. In either case, the Concessionaire shall provide UMLLC access to view and use for billing purposes real-time and archived meter data at any time. Archived data shall be available for download and review and shall not have any storage limitation. This data must be continually available during the term of the contract beginning on the date of the contract.
 - d) The Concessionaire shall ensure electronic metering occurs at a minimum of 60 second intervals.
 - e) The Concessionaire shall maintain accurate software, monthly meter data, and provide that data to the necessary University servers for use by the University for campus billing.
 - f) The Concessionaire shall collaborate with construction teams for new buildings being added to the University Campus to ensure timely installation of all metering and interface equipment at the time of connection. Additionally, appropriate start-up procedures shall be followed and monitored by the Concessionaire to ensure no impact to the Chilled Water System.
 - g) Plant production meters
 - i. Production meters for all energy producing systems must be in service when equipment is operating, functioning properly and reporting to a data system readily accessible by the University.
 - ii. Historical data on plant production meters shall be maintained at a minimum of 1-minute intervals and readily accessible for the University's review.
 - iii. Meters shall be calibrated and maintained in accordance with the manufacturer's recommendations. The schedule for such calibration shall follow the Preventive and Predictive Maintenance Plans.
- 5) **Efficiency**
- a) The Concessionaire shall operate the Chilled Water System plants in a manner to ensure reliability as well as optimization of energy and conservation of natural resources. The Concessionaire shall use commercially reasonable efforts, consistent with Prudent Industry Practices, to continuously improve the operating efficiency and use of resources including water for the Chilled Water System.
- 6) **Design Standards**
- a) The Concessionaire shall maintain and keep up to date an accurate Chilled Water and Steam System hydraulic models, which may be Pipe-Flo or other similar modeling software, in order to:

- i. Inform new buildings being connected to the Systems of the design pressure drop requirements based on system hydraulic models; and
 - ii. Verify and maintain system flow velocities according to design standards.
- b) The Concessionaire shall cause the Chilled Water and Steam System to adhere to pipe velocity limits as set forth in the Design Standards, once Approved by UMLLC in accordance with Part II, Section 7(a) hereof.

7) **Unplanned Outage Notifications**

- a) The Concessionaire shall notify UMLLC, by calling the University Front Desk number, of any outage that constitutes an unplanned outage as defined in the KPIs and metrics defined separately.
- b) For any unplanned outage caused by the Concessionaire, the Concessionaire shall promptly and diligently, including 24-hour a day service, commence active work, regardless of potential delay by others, to correct the equipment or system deficiency and restore service; unless otherwise approved by UMLLC in its sole discretion.
- c) An Unplanned Outage for the General Chilled Water Portion of the Utility System (as defined in Schedule 15 of the Concession Agreement) shall mean the occurrence of one of the following:
 - i. Chilled water supply temperature exceeds 50 degrees at any building interface supply point for 30 continuous minutes or more or supply pressure at any building interface falls below 20 psi for 30 continuous minutes as measured by the chilled water interface temperature and pressure transmitters identified on Appendix H for Chilled Water System Unplanned Outages as monitoring points, provided that it shall not be an Unplanned Outage if the supply temperature or the pressure is below those levels if the applicable University building's automation system is not requesting chilled water at that time.
 - ii. Chilled water supply is interrupted to a building due to a closed or inoperable distribution valve, leakage, pipe failure, or other system failure on the chilled water distribution system; except in the case where the valve has been closed upon the request of the University.
 - iii. The Concessionaire fails to provide sufficient notice for such outage to be a Planned Outage.
- d) An Unplanned Outage for the Chilled Water Tank (Thermal Energy Storage) shall mean the occurrence of one of the following:
 - i. Failure to maintain a thermocline level of at least 30 at a temperature of 46 degrees or below.

- ii. The Concessionaire fails to provide sufficient notice for such outage to be a Planned Outage.
 - e) The Concessionaire shall notify the University by calling the University Front Desk Number and the Manager of the Energy Plant which is currently (208) 885-6271 and this may be updated by notice from the University to the Concessionaire (the “University Energy Plant Number”) if there is excessive chilled water loop makeup of more than 25 gallons per minute for 5 continuous minutes or an average of 2 gallons per minute or more over a 24 hour period.
 - f) If an Unplanned Outage for the Chilled Water System occurs which causes a loss of service to a portion of the Utility System, the Concessionaire shall promptly and diligently, including 24-hour a day service, commence active work, regardless of potential delay by others, to correct the Chilled Water System Unplanned Outage and restore service; unless otherwise approved by the University in its sole discretion.
 - g) If operational issues occur that result in a high loop temperature event (greater than 50 degrees for 30 minutes) for the Chilled Water System, the Concessionaire shall:
 - i. Notify the University by calling the University Front Desk Number;
 - ii. Begin necessary corrective action;
 - iii. Provide updates as needed based on changes in the status of the Chilled Water System (and at least daily) and as more frequently as reasonably requested by the University to UI Facilities Management by calling the University Front Desk Number if an incident exceeds 15 minutes or more.
- 8) **Redundancy**
- a) The Concessionaire shall maintain an N+1 level of redundancy for the Utility System Assets that produce chilled water and steam. “N+1” is defined as the ability to meet seasonal peak load assuming the largest capacity Utility System Asset is non-functional.
 - b) If the Chilled Water or Steam system is below an N+1 level of redundancy, the Concessionaire shall promptly and diligently commence active work to correct the loss of system reliability within 48 hours.
 - c) The Concessionaire shall maintain existing standby generators (see list [●]) in accordance with manufacturers’ recommendations and Prudent Industry Practices with the rated capacity of at least the capacity in existence as of the Turnover. The University has the right to increase such requirement in its reasonable discretion, which shall be deemed a modification of these Performance Standards under Section 6.3(a) of the Concession Agreement.

- d) The Concessionaire shall perform standby generator testing for existing standby generators per manufacturers' recommendations.
- e) The Utilities Business Continuity Plan shall be tested annually in coordination with University Facilities Management staff. The date and time of each test shall be discussed with the University and agreed upon no less than 15 days in advance of such test.

9) **Water Quality**

- a) The Concessionaire shall adhere to the existing chemical and water treatment plan that it establishes as part of the Operations Plan, which treatment plan shall cover:

The Chilled Water System

The Cooling Tower System,

Boiler Feedwater System

Steam Distribution System including Condensate Return System

The plan shall reasonably address and prioritize the protection of health, life and safety of University students, employees, faculty and guests. Such plan shall cover frequency and validation of measurement and testing as well as the following items at a minimum:

- i. Scale and corrosion;
 - ii. Microbiological control;
 - iii. Copper corrosion;
 - iv. Maintaining closed loop water chemistry;
 - v. Cooling tower and condenser water:
 - 1. Scale and corrosion inhibitor;
 - 2. Maintain biological growth to industry standards to protect staff and maintain equipment efficiency
- b) The Concessionaire shall require the chilled water systems in a new building that is to be connected to the Chilled Water System to be flushed and treated to central plant standards by the building owner or construction team before connecting to the Chilled Water System.

Part IV - PERFORMANCE STANDARDS STEAM AND CONDENSATE SYSTEM

1) Temperature Requirements

- a) The Concessionaire shall operate steam boilers to produce saturated steam between 30 psi (274 degrees) and 60 psi (307.4 degrees) for the University Campus.
- b) The Concessionaire must ensure that each building served by the Steam and Condensate System maintain a minimum pressure of 30 psi.

2) Pressure Requirements

- a) The Concessionaire shall ensure that steam Energy Plant main headers will be maintained at 200 psig measured at the appropriate header pressure transmitter.
- b) The Concessionaire shall operate steam boilers to produce saturated steam between 30 and 60 psi for campus.
- c) The Concessionaire must ensure that each building served by the Steam and Condensate System maintain a minimum pressure of 30 psi.
- d) The monitoring points to determine compliance with such requirements are set forth on Appendix H.
- e) The Concessionaire shall track every 8 hours and propose plans to return the overall condensate return for the Steam and Condensate System to 3-year historic averages if the amount of condensate return drops more than 3% below the average annual return percent for the preceding 3 years.

3) Air Quality Permit with LDEQ

- a) The Concessionaire must immediately notify LSU EHS by calling the University Front Desk Number regarding any emissions excursions that do not comply with equipment operating permits (events that constitute a violation) The Concessionaire shall provide the EHS with a summary of the actions taken to correct the excess emissions event and the continuous monitoring data for the excess emissions event within 48 hours from the beginning of the event. LSU will report the event to applicable state and federal agencies. Concessionaire will make equipment logs and operating data available to UMLLC and support preparation of any notices and corrective actions to applicable State and Federal agencies.

4) Line of Demarcation between Concessionaire and University

- a) The line of demarcation for the Steam and Condensate System is each exterior wall of the Utility Facility providing Steam and Condensate, as further described on Appendix L-2.

- i. All steam piping up to the building isolation valve will be considered part of the Steam and Condensate System.
 - ii. All condensate piping from the condensate receiver pump outlet back to the Energy Plant shall be considered part of the Steam and Condensate System.
- b) The Concessionaire shall be responsible for using existing water and chemical treatment chemical treatment in the Utility Facilities.

5) **Metering**

- a) The Concessionaire shall maintain, operate and repair steam meters in accordance with the requirements set forth herein.
 - i. The Concessionaire shall ensure the meters are accurate and calibrated to the manufacturer's recommendations.
- b) As part of the Preventive and Predictive Maintenance Plans the Concessionaire shall include a plan to ensure metering accuracy and a metering accountability metric for such meters that are part of the Steam and Condensate System.
- c) The Concessionaire shall ensure electronic metering occurs at a minimum of 60 second intervals.
- d) The Concessionaire shall maintain accurate software, monthly meter data, and provide that data to the necessary University servers for use by the University for campus billing.
- e) The Concessionaire shall ensure that all new building connections to the Steam and Condensate System are metered at the time of connection.
- f) Plant production meters
 - i. Production meters for the Steam and Condensate System must be in service when equipment is operating, functioning properly and reporting to a data system readily accessible by the University. If a primary production meter fails, causing the Steam and Condensate System (or any portion thereof) to be unable to be operated under control, safely and effectively, the associated equipment shall be shut off until the failure is resolved, and the Concessionaire shall cause such meter to be replaced or repaired as soon as reasonably practicable.
 - ii. Historical data on plant production meters shall be maintained and readily accessible for the University's review. Raw data shall be provided to the University in a format that cannot be edited by the Concessionaire. Data will be time stamped with the date, hour (in 24 hr. format) and minute.

- iii. Meters shall be calibrated and maintained in accordance with the manufacturer's recommendations. The schedule for such calibration shall follow the Preventive and Predictive Maintenance Plans.

6) **Efficiency**

- a) The Concessionaire shall ensure that each boiler maintain a boiler fuel efficiency of 77% or greater.
- b) The Concessionaire shall ensure that the water recovery rate from the Hot Lime Softening System must be 99% or greater
- c) The Concessionaire shall operate the Steam and Condensate System in a manner to ensure reliability as well as optimization of energy and conservation of natural resources. The Concessionaire shall use commercially reasonable efforts to continuously improve the operating efficiency and use of resources including water for the Steam and Condensate System.

7) **Design Standards**

- a) The Concessionaire shall maintain and keep up to date accurate Steam and Condensate System models, which may be Pipe-Flo or other similar modeling software, in order to:
 - i. Inform new buildings being connected to the Steam and Condensate System of the design pressure drop requirements based on system models; and
 - ii. Verify and maintain system flow velocities.
- b) The Concessionaire shall adhere to the following pipe velocity limits for the Steam and Condensate System:
 - i. New piping for the steam portion of the Steam and Condensate System to be installed at 120 fps respectively at peak flow; and
 - ii. Existing piping that exceeds 120 feet per second ("fps") shall require University approval prior to replacement of the piping causing the velocity that exceeds 120 fps.
- c) [Reserved].
- d) The Concessionaire shall follow the Utility Service Connection and Inspection Standard set forth in the Design Standards.

8) **Unplanned Outage**

- a) An Unplanned Outage for the General Steam Portion of the Utility System (as defined in Schedule 15 of the Concession Agreement) shall mean the occurrence of

one of the following at the monitoring points identified on Appendix H for General Steam Portion of the Utility System Unplanned Outages.

- i. Steam pressure at a building supply pressure transmitter is less than 30 psi for 15 consecutive minutes or more;
 - ii. Steam supply is interrupted to a building due to loss of compressed air for the building pressure reducing valve, a closed or inoperable distribution valve, leakage, pipe failure, or other system failure; except in the case where the valve has been closed upon the request of the University; or
 - iii. The Concessionaire fails to provide sufficient notice for such outage to be a Planned Outage.
- b) An Unplanned Outage for the Steam Plant (as defined in Schedule 15 of the Concession Agreement) shall mean the occurrence of one of the following at the monitoring points identified on Appendix H for Steam Plant Unplanned Outages.
- i. The Steam Plant fails to provide at least 30 pi steam pressure to the General Steam Portion of the Utility System.
 - ii. The Concessionaire fails to provide sufficient notice for such outage to be a Planned Outage.
- c) If an Unplanned Outage of the Steam and Condensate System occurs, which causes a loss of service to a portion of the Utility System, the Concessionaire shall promptly and diligently, including 24-hour a day work, commence active work, regardless of potential delay by others, to correct the Unplanned Outage and restore service; unless otherwise approved by the University in its sole discretion.
- d) If operational issues occur that result in a low steam pressure or event for the Steam and Condensate System, defined as an instance where the Steam and Condensate System is providing steam at less than 30 psi for 15 minutes at a building pressure transmitter or any building connected to the Steam and Condensate System.
- i. Notify the University by calling the University Front Desk Number if any portion of the University Campus is affected.
 - ii. Immediately commence operation of the wood-fired and natural gas boilers to provide steam to the University Campus that meets the temperature and pressure requirements set forth herein, which wood-fired and natural gas boilers shall operate until such time as the Unplanned Outage is corrected;
 - iii. Begin necessary corrective action; and
 - iv. Provide updates every 60 minutes if outdoor temperatures are below 32 degrees, and every 24 hours otherwise, to UI Facilities Management by calling the University Front Desk Number if an incident exceeds 60 minutes

or 24 hours, as applicable, based on the appropriate notification timeline or more;

9) **Redundancy**

- a) Where possible, the Concessionaire shall maintain an N+1 level of redundancy for the Utility System Assets that make up the Steam and Condensate System. "N+1" is defined as the ability to meet seasonal peak load assuming the largest capacity Utility System Asset of the Steam and Condensate System is non-functional.
- b) If the Steam and Condensate System is below an N+1 level of redundancy, the Concessionaire shall promptly and diligently commence active work to correct the loss of system reliability within 48 hours.
- c) The Concessionaire shall ensure that at least one out of two steam lines that provide steam to the University Campus is functional at all times.
- d) Concessionaire shall use a chemical treatment plan for the Steam and Condensate System, as part of the Operations Plan, which must be at least as stringent as the chemical treatment plan existing as of the execution of the Concession Agreement. Such plan shall cover frequency and validation of measurement and shall adhere to ASME boiler water quality standards.
- e) The Concessionaire shall maintain standby generators for the Steam and Condensate System in accordance with manufacturers' recommendations and Prudent Industry Practices with the rated capacity of at least the capacity in existence as of the Turnover. The University has the right to increase such requirement in its reasonable discretion, which shall be deemed a modification of these Performance Standards under Section 6.3(a) of the Concession Agreement.
- f) The Concessionaire shall perform standby generator testing per manufacturer's recommendations.
- g) Concessionaire shall also include pretreatment standards as part of the Operations Plan, which shall include standards for:
 - i. Conductivity and hardness limits from water treatment plan; and
 - ii. Oxygen removal de-aerators.
- h) Concessionaire shall adhere to American Society of Mechanical Engineers boiler water quality standards.

10) **Energy Procurement**

- a) The Concessionaire will develop an annual monthly projection of fuel consumption and imported (purchased) power requirements for the campus. This will be completed on an on-going basis and be prepared by September 30 for the following

year. The Concessionaire will work closely with LSU staff in administering an energy procurement strategy.

11) **Condensate water storage**

The Concessionaire shall maintain the condensate storage at a continuous 6,000 gallon minimum volume.

DRAFT

Part V - PERFORMANCE STANDARDS – ELECTRIC SYSTEM

1) Power Requirements

- a) The Concessionaire shall design, procure, install, operate and maintain the Electric System within the Main and Highland plants.
- b) The Concessionaire shall operate and maintain the Electric System such that it meets the following power quality requirements using SEL revenue grade utility metering:
 - i. For harmonic distortion, comply with University Design Standards specifying maximum distortion allowable on the Electric System from connected loads, provided that the University shall cooperate with the Concessionaire to address distortion in excess of the maximum distortion allowable on the Electric System, to the extent such distortion is introduced by a connected load; and
 - ii. For voltage sag or swell events, investigate any such event and minimize internal system disruption and take affirmative measures to reduce sensitivity of key utility components to reduce trips from minor sag and/or swell events.
- c) Notwithstanding anything to the contrary contained herein, the Concessionaire shall operate the Utility System to participate in a Main Campus curtailment type program as directed by the University, and the Concessionaire shall not be in breach of any of the requirements of these Performance Standards if it operates in accordance with such curtailment.

2) Line of Demarcation; Concessionaire, University, and Electric Utility

- a) The Concessionaire is responsible to operate and maintain all electrical infrastructure within the plants including transformers, isolation switches, switchgear, variable frequency drives, motor control centers, power distribution panels, all panels and subpanels and distribution system feeding individual components in the plants.
- b) The Concessionaire will work closely with University Staff in developing procedures and plans associated with utilizing plant equipment to response to short and long term electrical outages. The Concessionaire acknowledges that the cogeneration system is a key and primary asset associated with response to electric utility outages.
- c) The line of demarcation for the Electric System is each exterior wall of the Utility Facility providing Electricity, as further described on Appendix L-3.

3) **Metering**

- a) The Concessionaire shall maintain, operate and replace Electric meters in accordance with the requirements set forth herein.
 - i. The Concessionaire shall ensure the revenue grade meters are accurate and calibrated to the manufacturer's recommendations.
 - ii. Concessionaire shall provide UMLLC with all information from the meter readings, in a format prescribed by UMLLC and in a manner that allows the University to maintain, without interruption, the University's then-current internal system for usage recording and billing.
- b) As part of the Preventive and Predictive Maintenance Plans developed in Section 1(i)(iv), the Concessionaire shall include a plan to ensure metering accuracy and a metering accountability metric for such meters that are part of the Electric System and applicable to this contract. For the avoidance of doubt, the Concessionaire shall adhere to all applicable requirements with respect to meters set forth in the Design Standards attached as Appendix B. Electric meters to be maintained per requirements of electric metering codes and guidelines.
- c) The Concessionaire shall ensure that all revenue grade and "other" meters required to measure performance associated with contract KPIs and metrics are connected to the new plant control and data acquisition system. The University shall have reasonable access to view the real-time meter data for all meter sites as well as have the ability to download data (or have the Concessionaire download and provide data) for analysis.
- d) The Concessionaire shall ensure electronic metering occurs at a minimum of 60 second intervals.
- e) The Concessionaire shall maintain accurate software, monthly meter data, and provide that data to the necessary University servers for use by the University for campus billing, utility assessments.
- f) Substation and campus feeder meters.
 - i. Main substation and customer meters that are part of the Electric System must be in service when equipment is operating, functioning properly and reporting to a data system accessible by the University. If a meter or its network communications fails, it shall be repaired as expeditiously as possible
 - ii. Main substation meters shall have event capture capability and store wave form level detail during periods of electrical disturbance.
- g) The Concessionaire shall maintain Schweitzer Engineering Laboratories (SEL)-735 revenue meters (or an equivalent Approved by UMLLC in its discretion)

on all of the substation transformers and can also compare meter readings to the Utility Feed Meters where applicable and SEL relays (or an equivalent, in each case, Approved by UMLLC in its discretion). The Concessionaire shall then compare internal meters monthly to billed consumption from the serving utility promptly and shall report such result to UMLLC.

4) **Efficiency**

- a) The Concessionaire shall operate the Electric System in a manner to ensure reliability as well as optimization of energy and conservation of natural resources. The Concessionaire shall use commercially reasonable efforts to continuously improve the operating efficiency and use of resources for the Electric System.

5) **Design Standards**

- a) The Concessionaire shall adhere to the University's Design Standards and all legal requirements for the Electric System, including without limitation, IEEE and NFPA.
- b) The Concessionaire is prohibited from installing, constructing or using above grade transmission and distribution lines, except as Approved by the University on a case by case basis.

6) **Unplanned Outage**

- a) An Unplanned Outage for the Electric System shall mean the occurrence of one of the following at the monitoring points identified on Appendix H for Electric System Unplanned Outages:
 - i. A distribution feeder breaker, building transformer failure, primary fuse or primary switch opens, secondary service protector main or feeder breaker opens, or any other cause determined by the University (acting reasonably) to originate within the Utility System which interrupts service to a building connected to the Electric System (in each case, except where such event is caused by a fault within a building, or other campus infrastructure, beyond the line of demarcation for the Utility System); or
 - ii. The Concessionaire fails to provide sufficient notice for such outage to be a Planned Outage.
- b) If an Unplanned Outage of the Electric System occurs which causes a loss of service, the Concessionaire shall promptly and diligently, including 24-hour a day work, commence active work to correct the Unplanned Outage and restore service, regardless of potential delay by others. Such updates shall be deemed a modification under Section 6.3(a) of the Concession Agreement.

- c) If there is an Unplanned Outage of the Electric System, the Concessionaire shall:
 - i. Notify UMLLC by calling the University Front Desk Number if any portion of the University Campus is affected.
 - ii. Begin necessary corrective action; and
 - iii. Provide updates every 24 hours to UI Facilities Management by calling the University Front Desk Number if an incident exceeds 24 hours or more;
- d) The Concessionaire shall communicate with UMLLC when it becomes aware of an External Electric Utility line or service feed that is out of service and is impacting any University Facilities, or plans to perform such work that could impact reliability for the University.

7) **Redundancy**

- a) Where applicable, the Concessionaire shall maintain an N+1 level of redundancy for the Utility System Assets that make up the Electric System. “N+1” is defined as the ability to meet seasonal peak load assuming the largest capacity Utility System Asset of the Electric System is non-functional.
- b) If the Electric System is below an N+1 level of redundancy, the Concessionaire shall promptly and diligently commence active work to correct the loss of system reliability within 48 hours.
- c) Each component of the Electric System shall have at least one independent backup.
 - i. For each substation in the Electric System, maximum capacity shall be met with the loss of a single transformer or bus.
 - ii. For distribution feeders in the Electric System:
 - 1. Buildings must be assigned a normal and alternate feed (except for those facilities radially fed); and
 - 2. Feeder loading shall be maintained prudently below protective relay settings in accordance with Prudent Industry Practices.
 - iii. For building service substations in the Electric System, they shall be in a main-tie-main configuration for critical facilities such as, research facilities and larger stadiums and may be single-ended for non-critical facilities. This main-tie-main applies to East and West feed interconnectivity.
- d) The Concessionaire shall operate, maintain and replace, as necessary, the gas engines that provide emergency back-up power to certain buildings on the University Campus, such that they shall provide at least the quality and quantity of backup service as exists on the Setting Date.

- e) The Concessionaire shall participate in annual power-loss testing on the University Campus at such times and in such frequency as reasonably requested by UMLLC.
- f) The Concessionaire shall operate, maintain and replace, as necessary, the gas engines at North Dairy Campus that provide emergency back-up power to certain buildings on the University Campus in the same manner that it is required to operate, maintain and replace the rest of the Utility System, such that they shall provide at least the quality and quantity of backup service as exists on the Effective Date.

8) **Distribution System Switching**

- a) The Concessionaire shall maintain a table of relay settings on feeders and substation transformers for the Electric System in accordance with Prudent Industry Practices.
- b) The Concessionaire shall provide switching for planned maintenance, curtailment or construction outages for the Electric System. Switching shall result in no unplanned interruption to the University.
- c) Switch loading for the Electric System shall be done as required to comply with the following load limits:
 - i. Bus limits;
 - ii. Transformer load limits; and
 - iii. Feeder loading limits.
- d) The Concessionaire shall provide low voltage switching and support for building outages.
- e) As requested by UMLLC for planning/design, for the duration of construction of new facilities on the University Campus, the Concessionaire shall provide construction power and support which shall include metering.

Part VI - PERFORMANCE STANDARDS – UTILITY SCADA NETWORK SYSTEM

1) Availability Requirements

- a) The Concessionaire shall ensure that the data infrastructure and network assets for the Utility System that transmit all data gathered by the network devices for the Utility System and transmits all other data and electronic information within the Utility System and all Utility Facilities to the data historians (the “Utility Network”) is maintained in accordance with Prudent Industry Practices and is maintained in a manner that it has available all data information reasonably necessary for safe plant and distribution system operation as well as commodity billing and that it stores all such data and information gathered by the Utility Network.

2) Line of Demarcation between Concessionaire and University

- a) The Utility Network is separated from the University Campus network by a physical Fortinet firewall which will be operated and maintained by the Concessionaire. Data shall be made available outside the Utility Network via an University Approved SCADA and control system server. This server shall exist behind the physical firewall and shall maintain the capability to pass data to a University-owned PI Server, which resides on the University’s network, via PI-to-PI protocol, PI-Connector, or other University-Approved secure connection. Concessionaire shall have the option to maintain for its own use any other PI system elements, such as a PI AF Server and/or PI Vision capabilities behind the firewall. The University will have the right to determine which PI assets it will utilize on its side, as shown in Appendix I. For clarity, Appendix I illustrates the PI configuration that the Concessionaire will be required to adhere to on the Turnover Date. All assets used to manage data on the Utility Network, including the firewall, a PI Server (or any approved successor server) shall be included in the Utility Network System as shown on Appendix I.
- b) Additionally, the Utility Network System extends into University Buildings to collect metering data from Utility System Meters. The demarcation of the Utility Network System components within the buildings is also provided in Appendix I.

3) Utility Network Components

- a) The Concessionaire shall monitor, maintain and operate the Utility Network system components in accordance with the requirements set forth herein.
- b) The Concessionaire shall provide annually, as part of the Operations Plan, a plan to keep Utility Network components updated with a replacement plan for any outdated equipment. If network equipment ages to the point that it no longer will take updates in security, operating system, or process software provided by the developer of such equipment, then the equipment shall be replaced within 6 months after such point.

- c) The Concessionaire shall use software of its own choosing, compatible with the operating software of the plant control system, to acquire, monitor and maintain Utility consumption data from the Utility System, subject to the Approval of UMLLC.
- d) The Concessionaire shall ensure control and data reliability appropriate for the criticality of the monitored devices.
- e) All metering shall be revenue grade where applicable, and will be connected to the Utility Network using a network interface or University-Approved telemetry.
- f) An Unplanned Outage of the Utility Network shall not be a KPI Event; however, for purposes of the definition of Repetitive Performance Standards Failure, either (i) more than 3 Unplanned Outages of the Utility Network or (ii) if there are more than 8 Outage Hours (as defined in Schedule 15) in any given Fiscal Year shall be considered a breach of the Performance Standards.

4) **Unplanned Outage**

- a) An Unplanned Outage for the Utility Network shall mean the occurrence of one of the following:
 - i. Loss of a key component of the Utility Network system that creates immediate operability issues;
 - ii. Loss of a key component of the Utility Network system that causes a loss of redundancy in key systems; or
 - iii. An unrecoverable loss of utility billing data for a period of more than 24 hours.
- b) If an Unplanned Outage for the Utility Network System occurs which causes a loss of service to a portion of the Utility System, the Concessionaire shall promptly and diligently, including 24-hour a day service, commence active work, regardless of potential delay by others, to correct the Utility Network Unplanned Outage and restore service; unless otherwise Approved by UMLLC in its sole discretion.
- c) If operational issues occur that result in an outage for the Utility Network System, the Concessionaire shall:
 - i. Begin necessary corrective action within 2 hours for Emergency Situations (as defined below), and as soon as reasonably practicable for Urgent Situations (as defined below):
- d) An “Emergency Situation” occurs with respect to the Utility Network if there is a (i) loss of network; (ii) loss of server; (iii) loss of PLC (CW interface); (iv) loss of network switch or router; (v) failure of substation relay; or (vi) a water plant issue endangering production.

- e) An “Urgent Situation” occurs with respect to the Utility Network if there is:
 - (i) redundancy lost in any network system; or
 - (ii) a Utility System meter offline;

5) **Redundancy**

- a) Where possible, the Concessionaire shall maintain appropriate levels of redundancy for the Utility System Assets that make up the Utility Network System, so that secure and continuous operation can be maintained at all times. As part of such redundancy, the Concessionaire shall adhere to the following backup policy:
 - i. Full and incremental backups protect and preserve corporate network information and should be performed on a regular basis for system logs and technical documents that are not easily replaced, have a high replacement cost or are considered critical, consistent with the University’s Institutional Data Backup Policy, attached hereto as Appendix K. Backup systems should be housed in a secure and geographically separate location from the original and isolated from environmental hazards. Backup network components, cabling and connectors, power supplies, spare parts and relevant documentation should be stored in a secure area on-site as well as at other corporate locations. For the avoidance of doubt, backup media, data and other information may be stored on non-physical offsite data storage solutions.
 - ii. System databases
 - 1. A copy of the most current network and system databases must be made at least twice per month or based on frequency of changes made.
 - 2. The lead network administrator is responsible for this activity.
 - iii. Access to backup databases and other data are tested annually.

LIST OF APPENDICES

Appendix A	Safety, Health and Environment Policy
Appendix B	Design Standards
Appendix C	Facilities Emergency Management Plan
Appendix D	Surveillance Procedures
Appendix F	Asbestos Management Program
Appendix G	Utility System Operating Efficiency Metrics
Appendix H	Monitoring Points
Appendix I	Utility Network Map
Appendix J	Policies and Procedures for use of University's IT Network
Appendix K	Institutional Data Backup Policy
Appendix L	Lines of Demarcation
Appendix L-1	Chilled Water System
Appendix L-2	Steam and Condensate System
Appendix L-3	Electricity System

UNIVERSITY EMPLOYEE SERVICES AGREEMENT

THIS UNIVERSITY EMPLOYEE SERVICES AGREEMENT (this “Agreement”) is made and effective as of the Turnover Date, by and among:

I. The Board of Supervisors of Louisiana State University and Agriculture and Mechanical College, a body corporate and politic existing under the laws of the State of Louisiana (the “University”);

II. Utilities Modernization LLC, a limited liability company existing under the laws of the State of Louisiana (“UMLLC”); and

III. [*Concessionaire Name*], a limited liability company existing under the laws of the State of Delaware (the “Concessionaire” and, collectively with the University and UMLLC, the “Parties”).

RECITALS

A. University and UMLLC have entered into that certain Long-Term Lease and Concession Agreement for the Louisiana State University Utility System, dated as of [•] (as may be amended, modified or supplemented, the “Prime Lease”), pursuant to which UMLLC is leasing the Utility System from the University to develop and implement a comprehensive modernization, operations and maintenance solution for the Utility System (the “Utilities Modernization Initiative”).

B. In order to achieve the Utilities Modernization Initiative, UMLLC and the Concessionaire have entered into that certain Long-Term Sub-Lease and Concession Agreement for the Utility System, dated as of [•] (as may be amended, modified or supplemented, the “Concession Agreement”), pursuant to which the Concessionaire is sub-leasing the Utility System from UMLLC and agreeing to provide the Utility Services (as defined in the Concession Agreement) for a term of 30 years.

C. In connection with the consummation of the transactions contemplated by the Prime Lease and the Concession Agreement and in accordance with Section 2.4(d) of the Concession Agreement, the University has agreed to provide certain services to the Concessionaire on the terms and conditions set forth herein.

D. Capitalized terms used but not defined herein have the meanings given to them in the Concession Agreement.

AGREEMENT

Accordingly, the Parties agree as follows:

1. Reassigned Employees

1.1 Provision of Reassigned Employees.

Subject to the terms and conditions of this Agreement, from the Turnover Date until the earliest of the following dates (in each case, with respect to such employee, such employee's "Reassignment Period"):

- (a) the End Date;
- (b) the date on which the University discontinues the assignment of such employee to provide such employee's Services (as defined herein);
- (c) the date on which the University terminates the employment of such employee or such employee resigns from such employment; and
- (d) the [*tenth*] anniversary of the Turnover Date (the "Agreement Expiry Date");

the University shall provide to the Concessionaire the services of each University employee set forth in Exhibit A hereto (each, a "Reassigned Employee") to provide such employee's respective Services in accordance with the terms of this Agreement. For the avoidance of doubt, neither the University nor UMLLC shall have the obligation to provide the Services provided by any Reassigned Employee following the end of such employee's Reassignment Period; nor shall the University or UMLLC have the obligation to replace such employee.

1.2 Expiration and Early Termination.

- (a) Unless the Reassignment Period with respect to all Reassigned Employees has expired pursuant to Section 1.1 of this Agreement, or this Agreement has been earlier terminated pursuant to clause (b) of this Section 1.2, this Agreement will expire on the Agreement Expiry Date.
- (b) [*Each Party may terminate this Agreement for any reason by notice to the other Parties with thirty (30) days' advance notice pursuant to Section 3.1 of this Agreement.*]

1.3 Services of the Reassigned Employees.

- (a) During the Reassignment Period with respect to any Reassigned Employee, the University shall direct such Reassigned Employee to devote such Reassigned Employee's full business time to perform those functions and services, and at such locations, as were performed by such Reassigned Employee for the benefit of the University immediately prior to the Turnover Date and such other functions and services, and at such other locations, as the Concessionaire may reasonably request and which other functions the University approves in its reasonable discretion (with respect to each Reassigned Employee, the "Services"); provided that the University will direct each Reassigned Employee to perform such employee's respective Services provided by such employee to a standard not less than

the standard to which such Services were provided by such employee prior to the Turnover Date.

- (b) Notwithstanding anything to the contrary contained herein or in the Concession Agreement, with respect to any performance of Services (or any failure to perform Services) by any Reassigned Employee that would cause either a Concessionaire Default, the Operator to fail to comply with the Performance Standards, or Losses to UMLLC, UMLLC hereby waives any claim against the Concessionaire or the Operator (or their respective Contractors) for such Concessionaire Default, failure to comply with the Performance Standards or Losses, as a result thereof, provided that such waiver shall not apply to (i) any performance or failure to perform specifically requested, or directed, by the Concessionaire or the Operator (or their respective Contractors) or (ii) any such performance or failure continuing after the expiration or early termination of this Agreement, but only to the extent of such performance or failure to perform after the expiration or early termination of this Agreement.
- (c) The University represents and warrants that each of the Reassigned Employees is a University Utility System Employee as of the date of this Agreement.

1.4 Employment Status.

- (a) Notwithstanding any provision of this Agreement to the contrary, during the Reassignment Period, (a) each Reassigned Employee will be considered employees of University and not an employee of either the Concessionaire, the Operator or any of their respective Contractors or Representatives, (b) the University will direct and control the Reassigned Employees in accordance with such employment relationship, to the extent needed for the University to perform its obligations under this Agreement, (c) nothing herein shall alter the employment status of the Reassigned Employees and the University may discontinue the assignment of the Reassigned Employees to provide Services at any time within its reasonable discretion by written notice to the Concessionaire, and (d) nothing herein shall restrict the right of the University to terminate the employment of any Reassigned Employee or affect the right of such employee to resign from the employment of the University.
- (b) During the Reassignment Period, the Reassigned Employees will not be eligible for, or entitled to participate in, any benefit or compensation plans, arrangements or distributions of or by the Concessionaire, the Operator or any of their respective Contractors or Representatives, except to the extent any such Reassigned Employees enters into a contract or agreement with the Concessionaire, the Operator or any of their respective Contractors, directly for any of the foregoing. To the extent that any Reassigned Employee is deemed to be eligible to participate in any benefit or

compensation plans, arrangement, or distributions of or by the Concessionaire, the Operator, or any of their respective Contractors or Representatives, which is not contemplated or anticipated, the Concessionaire and/or the Operator agree to bear any and all associated expenses, costs, and liabilities related to such eligibility and/or participation, as applicable.

1.5 Compensation/Payroll. During the Reassignment Period with respect to each Reassigned Employee, the University shall be responsible for paying such Reassigned Employee's salaries, wages and benefits (including payment of employer contributions to the Louisiana State Employees Retirement System pursuant to La. R.S. 11:441, the Louisiana Deferred Compensation Plan, and social security or other retirement systems, as applicable, in each case meeting the University's employer contribution rate as determined annually by the State). All Reassigned Employees' payroll withholding elections (such as those related to income taxes, qualified retirement plans, group health and welfare plans, etc.) shall remain the same during the Reassignment Period as such elections were as of the Turnover Date, except to the extent that a Reassigned Employee elects (in a manner permitted to employees and plan participants generally) to change any such election. In addition, if the University elects or is otherwise obligated to make any such payments, then it shall be responsible for paying any severance and merit bonus amounts to Reassigned Employees or former Reassigned Employees at the University's discretion. During the Reassignment Period, the Reassigned Employees are responsible for complying with the University's policies on timekeeping and overtime, if applicable, and the Concessionaire is not authorized to give any instructions that would in any way modify such policies.

1.6 Compliance With Employment Law.

- (a) The University shall be responsible for compliance with all applicable legal obligations in respect of the Reassigned Employees relating to payroll and benefit plan matters covered under this Agreement. The University shall bear responsibility to respond to any questions and inquiries from federal, state and local agencies, and other Persons regarding payroll and employment data and history relating to the Reassigned Employees and concerning the Reassignment Period or any prior period.
- (b) In addition, without limiting clause (a) of this Section 1.6, during the Reassignment Period with respect to any Reassigned Employee, the University shall be responsible for compliance with all applicable local, state and federal employment law requirements relating to the Reassigned Employees, including, without limitation, obligations under the Immigration Reform and Control Act of 1986, the National Labor Relations Act, the Civil Rights Act of 1964, the Americans with Disabilities Act, the Age Discrimination in Employment Act, the Fair Credit Reporting Act, and the Fair Labor Standards Act. The Concessionaire agrees to follow all University policies and agrees that the Concessionaire's own employees

must comply with applicable state and federal employment laws while conducting services at the University. The Concessionaire and its employees must promptly report any and all incidents of harassment, discrimination, retaliation, or other violations of federal or state EEO law to [●] and shall otherwise not act inconsistently with this Agreement.

- (c) The University represents and warrants, to the Actual Knowledge of the University, as of the date of this Agreement, that it is not in violation of any of the employment laws listed in clause (b) of this Section 1.6 in respect of the Reassigned Employees. The University covenants that, to the extent there are any lawsuits, charges or other administrative or governmental proceedings pending against the University relating to or involving any of the Reassigned Employees, including, for the avoidance of doubt, workers' compensation claims, as of the date hereof ("Existing Employee Claims"), the University shall be responsible for the defense of, and payment of any amounts related to, such Existing Employee Claims.

1.7 Payment Obligations.

- (a) The Concessionaire will have a payment obligation to the University and its Representatives with respect to any and all losses, costs, fees and expenses that arise from any wrongful or negligent act, omission or failure to act, of the Concessionaire or the Operator (or their respective Contractors or Representatives) with respect to the Reassigned Employees or the Services.
- (b) The University shall have a payment obligation to the Concessionaire and the Operator (and their respective Contractors and Representatives) with respect to any and all losses, costs, fees and expenses arising from any wrongful or negligent act, omission or failure to act of the University or a breach of this Agreement by the University, provided that nothing herein shall cause the University to be liable to the Concessionaire or the Operator (or their respective Contractors or Representatives) for any actions or failures to act taken by any of the Reassigned Employees at the direction of the Concessionaire or its Representatives or outside the scope of the applicable Reassigned Employee's employment.
- (c) For greater certainty, and notwithstanding clause (b) of this Section 1.6, the University will have a payment obligation to the Concessionaire and the Operator (and their respective Contractors and Representatives) with respect to all claims, losses, and liabilities incurred during the Reassignment Period arising out of or related to any allegation or finding that the Concessionaire or the Operator (or their respective Contractors or Representatives) is a joint employer of any Reassigned Employee during the Reassignment Period with respect to such employee as defined by applicable federal or state law; provided that nothing in this clause (c) is intended to relieve the Concessionaire and/or the Operator (or their respective Contractors or Representatives) from liability with respect to

claims, losses, and liabilities arising out of or related to their own respective violations of applicable federal or state law with respect to the Reassigned Employees.

2. Payment for Services

For the Services provided by the Reassigned Employees during their respective Reassignment Periods, the University shall provide the Concessionaire with an invoice within thirty (30) Days after the end of each calendar month setting forth the salaries, wages and benefits described in Section 1.5 and the costs described in Section 1.6 incurred in such month with respect to each Reassigned Employee (the “Fee”). The Concessionaire shall pay the Fee to the University within thirty (30) Days after receipt of such invoice.

3. Miscellaneous

3.1 Notices. All notices or other communications provided for under this Agreement shall be in writing, signed by the Party giving the same, and shall be delivered by email, nationally recognized overnight courier service or certified or registered mail (return receipt requested and postage prepaid) for the attention of the persons and to the addresses or email addresses shown below (or such other persons, address or email addresses as either party may from time to time designate by a notice to the other):

To the University:

- [•]
- [•]
- [•]
- [•]
- [•]

With a copy to:

- [•]
- [•]
- [•]
- [•]

For delivery by email:

- [•]
- Email: [•]

With a copy to:

- [•]
- Email: [•]

To UMLLC:

Utilities Modernization LLC
c/o LSU Real Estate and Facilities Foundation
Attn: Vice President & General Counsel
3796 Nicholson Drive
Baton Rouge, LA 70802

With a copy to:

- [•]
- [•]
- [•]

For delivery by email:

Vice President & General Counsel (Foundation)
Email: lgreco@lsufoundation.org

With a copy to:

- [•]
- Email: [•]

With a copy to:

- [•]
- [•]
- [•]
- [•]

With a copy to:

- [•]
- [•]
- [•]
- [•]

For delivery by email:

- [•]
- Email: [•]

With a copy to:

- [•]
- Email: [•]

With a copy to:

- [•]
- Email: [•]

A notice shall be deemed to have been sent and received (i) on the Day it is delivered, or if such Day is not a Business Day or if the notice is received after ordinary office hours (time of place of receipt), the notice shall be deemed to have been sent and received on the next Business Day, or (ii) on the 4th Business Day after mailing if sent by U.S. registered or certified mail. Each party shall use commercially reasonable efforts to deliver an electronic copy of each notice provided by mail in accordance with the foregoing via email to the persons and email addresses designated pursuant to the foregoing to receive Notices provided by email

- 3.2 Entire Agreement. This Agreement constitutes the entire agreement between the Parties pertaining to the subject matter hereof and supersedes all prior agreements, negotiations, discussions and understandings, written or oral, among the Parties. There are no representations, warranties, conditions or other agreements, whether direct or collateral, or express or implied, that form part of or affect this Agreement, or that induced any Party to enter into this Agreement or on which reliance is placed by any Party, except as specifically set forth in this Agreement. The Parties

acknowledge and agree that (i) each has substantial business experience and is fully acquainted with the provisions of this Agreement, (ii) the provisions and language of this Agreement have been fully negotiated and (iii) no provision of this Agreement shall be construed in favor of any Party or against any Party by reason of such provision of this Agreement having been drafted on behalf of one Party rather than the other.

- 3.3 Amendment. This Agreement may be amended, changed or supplemented only by a written agreement signed by the Parties.
- 3.4 Waiver of Rights. Any waiver of, or consent to depart from, the requirements of any provision of this Agreement shall be effective only if it is in writing and signed by the Party giving it, and only in the specific instance and for the specific purpose for which it has been given. No failure on the part of any Party to exercise, and no delay in exercising, any right under this Agreement shall operate as a waiver of such right. No single or partial exercise of any such right shall preclude any other or further exercise of such right or the exercise of any other right.
- 3.5 Severability. Each provision of this Agreement shall be valid and enforceable to the fullest extent permitted by applicable Law. The invalidity of any one or more phrases, sentences, clauses or sections contained in this Agreement shall not affect the remaining portions of this Agreement or any part thereof. If any provision of this Agreement or the application thereof to any Party or circumstance is held or deemed to be or determined to be invalid, inoperative or unenforceable in any particular case in any particular jurisdiction or jurisdictions because it conflicts with any other provision or provisions hereof or of any applicable Law, or public policy, or for any other reason, (i) such circumstance shall not have the effect of rendering the provision in question inoperative or unenforceable in any other case or circumstance, or rendering any other provision or provisions herein contained invalid, inoperative or unenforceable to any extent whatever, and (ii) the Parties shall negotiate in good faith to amend this Agreement to implement the provisions set forth herein.
- 3.6 Governing Law; Waiver of Jury Trial. This Agreement shall be governed by, and interpreted and enforced in accordance with, the Laws in force in the State of Louisiana (excluding any conflict of laws rule or principle which might refer such interpretation to the Laws of another jurisdiction).
- 3.7 Submission to Jurisdiction. Any action or proceeding against any Party relating in any way to this Agreement may be brought and enforced in the state courts in the State of Louisiana in the Parish of East Baton Rouge, and each Party hereby irrevocably submits to the jurisdiction of such courts with regard to any such action or proceeding, and irrevocably waives, to the fullest extent permitted by applicable Law, any objection it may have now or hereafter have to the laying of venue of any such action or proceeding in such courts and any claim that any such action or proceeding brought in any such court has been brought in an inconvenient forum.

- 3.8 Further Acts. The Parties shall do or cause to be done all such further acts and things as may be reasonably necessary or desirable to give full effect to this Agreement. Without limiting the foregoing, each Party will, at any time and from time to time, execute and deliver or cause to be executed and delivered such further instruments and assurances and take such further actions as may be reasonably requested by the other Party in order to cure any defect in the execution and/or delivery of this Agreement.
- 3.9 Costs. Except as otherwise provided in this Agreement, each Party shall be responsible for its own costs and expenses incurred in connection with performing and observing its obligations and covenants under this Agreement.
- 3.10 Interest. Any amount payable under this Agreement and not paid when due shall bear interest at a variable nominal rate per annum equal on each Day to the Bank Rate then in effect, from the date such payment is due until payment and both before and after judgment.
- 3.11 Inurement and Binding Effect. This Agreement shall inure to the benefit of the Parties and their respective permitted successors and assigns and is binding upon the Parties and their respective successors and assigns.
- 3.12 No Partnership or Third Party Beneficiaries. Except as expressly provided herein to the contrary, nothing contained in this Agreement shall constitute or be deemed to create a partnership, joint venture or principal and agent relationship among any of the Parties, nor shall any term or provision hereof be construed in any way to grant, convey or create any rights or interests to any person not a party to this Agreement.
- 3.13 Counterparts; Electronic Execution. This Agreement may be executed in any number of counterparts which, taken together, shall constitute one and the same agreement. This Agreement shall be effective when it has been executed by each Party and delivered to all Parties. To evidence the fact that it has executed this Agreement, a Party may send a copy of its executed counterpart to each other Party by email or other means of electronic transmission. Such Party shall be deemed to have executed and delivered this Agreement on the date it sent such email or other means of electronic transmission. In such event, such Party shall forthwith deliver to each other Party an original counterpart of this Agreement executed by such Party.
- 3.14 Time of the Essence. Time is of the essence for this Agreement.
- 3.15 Assignment. None of the Parties may, without the prior written consent of the other Parties, encumber, assign, grant any security interest over, hold on trust or otherwise transfer the benefit and obligations under this Agreement; provided that each of the University and UMLLC hereby consents to the assignment by the Concessionaire of all of its rights, title and interest in and to this Agreement, and the creation of a security interest over this Agreement, as collateral security for the benefit of the lenders to the Concessionaire.

Confidential LSU Comments of

October 1, 2021

Subject to Ongoing Review by LSU

[SIGNATURES ON THE FOLLOWING PAGE]

DRAFT

IN WITNESS WHEREOF, the Parties have caused their duly authorized officers to execute and deliver this Agreement as of the day and year first written above.

UNIVERSITY:

BOARD OF SUPERVISORS OF LOUISIANA
STATE UNIVERSITY AND AGRICULTURAL
AND MECHANICAL COLLEGE

BY: _____

PRINTED:

ITS:

UMLLC:

UTILITIES MODERNIZATION LLC

BY: _____

PRINTED:

ITS:

CONCESSIONAIRE:

[•]

BY: _____
PRINTED:
ITS:

EXHIBIT A

Reassigned Employees

#	Employee Last Name	Employee First Name
1.	[•]	[•]
2.	[•]	[•]
3.	[•]	[•]
4.	[•]	[•]
5.	[•]	[•]
6.	[•]	[•]
7.	[•]	[•]
8.	[•]	[•]
9.	[•]	[•]
10.	[•]	[•]
11.	[•]	[•]
12.	[•]	[•]
13.	[•]	[•]
14.	[•]	[•]
15.	[•]	[•]
16.	[•]	[•]
17.	[•]	[•]
18.	[•]	[•]
19.	[•]	[•]
20.	[•]	[•]
21.	[•]	[•]

SCHEDULE 5

UTILITY FEE

Calculation of Utility Fee

The Utility Fee for any given Fiscal Year shall be calculated as follows:

- (i) the Capped O&M Amount; plus
- (ii) the IMP Return on Equity Factor multiplied by (x) the First Gearing Factor applicable to the Initial Modernization Project multiplied by (y) the Variable Fee Component allocable to the Initial Modernization Project; plus
- (iii) the IMP Cost of Debt Factor multiplied by (x) the Second Gearing Factor applicable to the Initial Modernization Project multiplied by (y) the Variable Fee Component allocable to the Initial Modernization Project; plus
- (iv) the CI Return on Equity Factor multiplied by (x) the First Gearing Factor applicable to any Capital Improvement that is not the Initial Modernization Project multiplied by (y) the Variable Fee Component allocable to any Capital Improvement that is not the Initial Modernization Project; plus
- (v) the CI Cost of Debt Factor multiplied by (x) the Second Gearing Factor applicable to any Capital Improvement that is not the Initial Modernization Project multiplied by (y) the Variable Fee Component allocable to any Capital Improvement that is not the Initial Modernization Project; plus
- (vi) the Capital Recovery Amount; plus
- (vii) the Uncapped O&M Amount.

For the purposes of all calculations hereunder, all dollar amounts will be rounded to the nearest dollar, and all decimals, such as the Cost of Debt Factor and Return on Equity Factor, shall be rounded to the ten-thousandths place.

Notwithstanding anything to the contrary contained herein, costs or expenses may only be included in one component of the Utility Fee for any given period, and the Concessionaire shall not be entitled to double-count such costs or expenses in any one period.

The Parties acknowledge that the purpose of the formula to calculate the Utility Fee is to approximate a reasonable and market rate to be paid by UMLLC for the Utility Services commensurate of what would be paid for such services in the applicable market and is not necessarily intended to reflect the Concessionaire's actual cost of debt, return on equity, return of capital, tax liability, or similar items.

Abandoned Capital Improvements

If any New Approved Capital Improvement Costs were included in the calculation of the Utility Fee in any Fiscal Year for a Capital Improvement that UMLLC subsequently determines, in its reasonable discretion, that the Concessionaire has abandoned and does not ever intend to complete and bring into service for reasons other than a UMLLC Directive, a Delay Event, an Adverse Action, or any other change in requirements by UMLLC, those New Approved Capital Improvement Costs shall be removed from the Variable Fee Component and the Unrecovered Balance for each such Fiscal Year, and the Concessionaire shall promptly after receipt of notice of such determination recalculate the Utility Fee for such Fiscal Years resulting from the removal of such New Approved Capital Improvement Costs and pay to UMLLC, within thirty (30) Days of the determination by the Concessionaire, the difference between the Utility Fee actually paid by UMLLC and the Utility Fee that UMLLC would have paid if those New Approved Capital Improvement Costs had not been included.

Considerations for Setting First Gearing Factor and Second Gearing Factor for Capital Improvements Other than the Initial Modernization Project

With respect to certain of the First Gearing Factors and Second Gearing Factors applicable to Capital Improvements other than the Initial Modernization Project, the Parties will agree on such First Gearing Factors and Second Gearing Factors at the time of Approval of the relevant Capital Improvements, as set forth herein. In connection with such agreement, the Parties will evaluate several considerations, including the then-current market conditions for similar potential financing facilities and the then-prevailing market precedent for university utility system concession agreements of the type of this Agreement.

UMLLC Directives

To the extent that any UMLLC Directive requires the construction of a Capital Improvement, the cost of such Capital Improvement shall be included as a New Approved Capital Improvement Cost up to the Approved cost of such Capital Improvement set forth in such UMLLC Directive and, for the avoidance of doubt, the Utility Fee with respect to such Capital Improvement shall be calculated in accordance with the terms of this Schedule 5, including with respect to the considerations applicable to the setting of the First Gearing Factor and Second Gearing Factor described above applicable to such UMLLC Directive; *provided, however*, that the First Gearing Factor applicable to any UMLLC Directive shall be neither less than 0.2 nor more than 0.5 and the Second Gearing Factor applicable to any UMLLC Directive shall be neither more than 0.8 nor less than 0.5; *provided, further* that the sum of the First Gearing Factor and the Second Gearing Factor shall equal 1.0.

Exhibit A

Attached hereto as Exhibit A is an illustrative mathematical explanation and example of the Utility Fee formula, which, in the event of a conflict between Exhibit A and such formula, the formula set forth above shall control.

Definitions

“Actual Amount” shall mean, with respect to any Capital Improvement, the actual, out-of-pocket costs incurred by the Concessionaire for such Capital Improvement (which costs and expenses may include payments due and payable by the Concessionaire to the Operator or other Contractors pursuant to an Operating Agreement or similar agreement, insurance, any applicable sales or use tax, incremental financing costs, and bonding costs, in each case, to the extent disclosed in the Concessionaire’s request for approval of such Capital Improvement pursuant to Section 2.4(f) or Article 4 of the Agreement, as the case may be) in bringing such Capital Improvement into service. With respect to the Initial Modernization Project, the “Actual Amount” shall include the University Reimbursable Amount and shall exclude the Unexpended Contingency Amount.

“Approved Budgeted Amount” shall mean, with respect to any Capital Improvement, the amount budgeted for such Capital Improvement in UMLLC’s Approval thereof pursuant to Section 2.4(f) or Article 4 of the Agreement, as the case may be (which amount may include payments due and payable by the Concessionaire to the Operator or other Contractors pursuant to an Operating Agreement or similar agreement, insurance, any applicable sales or use tax, incremental financing costs, and bonding costs, in each case, to the extent disclosed in the Concessionaire’s request for approval of such Capital Improvement pursuant to Section 2.4(f) or Article 4 of the Agreement, as the case may be), to bring such Capital Improvement into service; *provided* that, for purposes of this Schedule 5, the Approved Budgeted Amount shall exclude the Unexpended Contingency Amount.

“Benchmark Index” shall mean the Bloomberg Barclays US Corporate 10+ Years Baa3-A3 Utilities Energy Transportation Index – Financial Instrument Global Identifier: BBG00JDL9P48 (or if such index is no longer published at the time of determination, such other index as reasonably agreed by the Concessionaire and UMLLC) on the date of determination.

“Benchmark Index Rate” shall mean the rate quoted at 4:00 p.m. Eastern Time, on each date of determination as the yield to worst reference place, expressed as a decimal to five (5) decimal places, set out in the Benchmark Index, which rate shall be determined as of the Turnover Date and as of first day of each fifth (5th) Fiscal Year; it being understood that such determination shall not be considered an amendment or modification of this Agreement, of this Schedule 5, or of the method of calculation of the Utility Fee (other than revising the input thereto for such Capital Improvement) and shall not require the approval of either the Concessionaire or UMLLC.

“Capital Improvement Cost” shall mean:

- (a) with respect to any Capital Improvement other than the Initial Modernization Project:
 - (i) if the Actual Amount is equal to, or greater than, the Approved Budgeted Amount, the Approved Budgeted Amount; and
 - (ii) if the Actual Amount is less than the Approved Budgeted Amount, the average between such Actual Amount and the Approved Budgeted Amount; and
- (b) with respect to the Capital Improvement Cost of the Initial Modernization Project:

- (i) if the Actual Amount is equal to, or greater than, the Approved Budgeted Amount for the Initial Modernization Project, the Actual Amount; and
- (ii) if:
 - (x) the Actual Amount is less than the Approved Budgeted Amount for the Initial Modernization Project;
 - (y) the IMP Substantial Completion Date occurs on or prior to the Planned IMP Substantial Completion Date; and
 - (z) there is no Concessionaire Default then-occurring,

then the Capital Improvement Cost with respect to the Initial Modernization Project shall be reduced by fifty-five percent (55%) of the difference by which the Actual Amount is less than the Approved Budgeted Amount; *provided* that if the IMP Substantial Completion Date is achieved ninety (90) days or more prior to the Planned IMP Substantial Completion Date, then the Capital Improvement Cost with respect to the Initial Modernization Project shall be reduced by forty-five percent (45%) of the difference by which the Actual Amount is less than the Approved Budgeted Amount for the Initial Modernization Project.

provided that, in the case of each of clause (a) and clause (b):

- (A) such Capital Improvement Cost shall be increased by any reasonable, actual out-of-pocket costs incurred by the Concessionaire due to a Delay Event that were unavoidable for reasons outside the Concessionaire's control, but excluding any amount budgeted for non-capital expenses with respect to such Capital Improvement, in each case taking into account any actual or anticipated tax credits or other benefits that will accrue to the Concessionaire (but only as and when such tax credit inures to the benefit of the Concessionaire and in the manner contemplated by the Approval of such Capital Improvement, if contemplated thereby); and
- (B) upon written request of the Concessionaire, UMLLC shall have the right, in its sole discretion, to increase the Capital Improvement Cost by some or all of the amount that the actual out-of-pocket costs incurred for such Capital Improvement exceeds the Approved Budgeted Amount.

"Capital Recovery Amount" shall mean the sum of the results of the following calculation, calculated separately for each New Approved Capital Improvement: (i) the New Approved Capital Improvement Costs incurred in the immediately prior Fiscal Year, *divided by* (ii) the Recovery Period for such New Approved Capital Improvement; which Capital Recovery Amount shall be included in each Fiscal Year's Utility Fee thereafter until such time as the Unrecovered Balance for such New Approved Capital Improvement Costs equals zero dollars (\$0); *provided* that, for the avoidance of doubt the Recovery Period for a New Approved Capital Improvement may extend beyond the Term.

“Capped O&M Amount” shall mean \$[3,360,851.18]¹, prorated based on the number of Days remaining after the Turnover in the Fiscal Year ending June 30, 2022, increased to [\$3,428,068.20] on July 1, 2022, for the Fiscal Year ending on June 30, 2023, and increased by two percent (2%) at the start of each Fiscal Year thereafter.

For the avoidance of doubt, the Capped O&M Amount is compensation for (x) the Concessionaire performing the Utility Services as set forth in the Agreement, (y) the risks and liabilities undertaken by the Concessionaire in the Agreement for which the Concessionaire may not otherwise be compensated under the Agreement, and (z) the expertise and technical know-how that the Concessionaire is expected to bring to bear on the Utility System and the Utility System Operations.

“Cost of Debt Factor” shall mean:

- (i) with respect to the Initial Modernization Project (the “IMP Cost of Debt Factor”), either:
 - (a) initially, [_____] [*Note to Draft: the amount reflecting the Concessionaire’s actual cost of debt with respect to the Initial Modernization Project as shown in the financing plan submitted to UMLLC by the Concessionaire and Approved by UMLLC*], or
 - (b) in connection with any refinancing of the Initial Modernization Project (an “IMP Refinancing”) that results in a cost of debt to the Concessionaire that is less than the Cost of Debt Factor set forth in clause (i)(a) above (when translated to a percentage), a factor equal to the average between Concessionaire’s cost of debt for the IMP Refinancing and the Cost of Debt Factor set forth in clause (i)(a) above (when translated to a percentage), and
- (ii) with respect to any Capital Improvement that is not the Initial Modernization Project (the “CI Cost of Debt Factor”), the Benchmark Index Rate that is then-applicable as of the date of the Approval of such Capital Improvement by UMLLC

“First Gearing Factor” shall mean:

- (i) with respect to the Initial Modernization Project, 0.1; *provided* that, in connection with any IMP Refinancing, the First Gearing Factor shall be adjusted so that, after giving effect to the such refinancing, the First Gearing Factor equals a fraction, the numerator of which is the amount equal to the equity in such refinancing, and the denominator of which is an amount equal to the New Approved Capital Improvement Cost for the Initial Modernization Project, and
- (ii) with respect to any Capital Improvement that is not the Initial Modernization Project: (A) for the first \$1,000,000 of aggregate New Approved Capital Improvement Costs for Capital Improvements that are not the Initial Modernization Project, the amount of 0.5; and (B) for any amount of aggregate New Approved Capital Improvement Costs

¹ **MB NOTE TO DRAFT:** CenTrio is confirming the accuracy of these numbers.

for Capital Improvements that are not the Initial Modernization Project in excess of such \$1,000,000, a factor to be agreed by the Parties at the time such Capital Improvement is approved by UMLLC pursuant to Article 4 of the Agreement; *provided, however*, that in no event shall the First Gearing Factor for such Capital Improvement be less than 0.1.

For the avoidance of doubt, the sum of the First Gearing Factor and the Second Gearing Factor shall equal 1.0.

“New Approved Capital Improvement” shall mean a Capital Improvement that was, or is being, constructed by the Concessionaire and is or will be brought into service as part of the Utility System, including the Initial Modernization Project.

“New Approved Capital Improvement Cost” shall mean, with respect to any Capital Improvement, the Capital Improvement Cost of such New Approved Capital Improvement.

“Recovery Period” shall mean (a) for the Initial Modernization Project, a period commencing at the beginning of the Fiscal Year following the Fiscal Year in which the Capital Improvement Costs for Initial Modernization Project are incurred and expiring on the expiration of the twenty-fifth (25th) full Fiscal Year following the commencement of such period, and (b) for each New Approved Capital Improvement, a period commencing at the beginning of the Fiscal Year following the Fiscal Year in which the applicable New Approved Capital Improvement Costs are incurred and expiring on the expiration of the twentieth (20th) full Fiscal Year following the commencement of such period, or such other period as agreed by UMLLC and the Concessionaire as part of UMLLC’s Approval of the applicable New Approved Capital Improvement, over which the Concessionaire shall recover the cost of that New Approved Capital Improvement in the Utility Fee pursuant to this Schedule 5, as such period may be adjusted pursuant to Section 4.3 of the Agreement.

“Return on Equity Factor” shall mean the following numbers, each “grossed up” by [27.32%] to account for the notional blended effective income tax rate applicable to the Concessionaire:

(i) with respect to the Initial Modernization Project (the “IMP Return on Equity Factor”), either:

(a) initially, 0.1, or

(b) in connection with any IMP Refinancing that results in a cost of equity to Concessionaire that is less than the Return on Equity Factor set forth in clause (i)(a) above (when translated to a percentage), a factor equal to the average between Concessionaire’s cost of equity for the IMP Refinancing and the Return on Equity Factor set forth in clause (i)(a) above (when translated to a percentage), and

(ii) with respect to any Capital Improvement that is not the Initial Modernization Project (the “CI Return on Equity Factor”), the amount of 0.1.

“Second Gearing Factor” shall mean:

- (i) with respect to the Initial Modernization Project, 0.9; *provided* that, in connection with any IMP Refinancing, the Second Gearing Factor shall be adjusted so that, after giving effect to the such refinancing, the Second Gearing Factor equals a fraction, the numerator of which is the amount equal to the debt in such refinancing, and the denominator of which is an amount equal to the New Approved Capital Improvement Cost for the Initial Modernization Project; and
- (ii) with respect to any Capital Improvement that is not the Initial Modernization Project: (A) for the first \$1,000,000 of aggregate New Approved Capital Improvement Costs for Capital Improvements that are not the Initial Modernization Project, the amount of 0.5; and (B) for any amount of aggregate New Approved Capital Improvement Costs for Capital Improvements that are not the Initial Modernization Project in excess of such \$1,000,000, a factor to be agreed by the Parties at the time such Capital Improvement is approved by UMLLC pursuant to Article 4 of the Agreement; *provided, however*, that in no event shall the Second Gearing Factor for such Capital Improvement be more than 0.9.

For the avoidance of doubt, the sum of the First Gearing Factor and the Second Gearing Factor shall equal 1.0.

“Uncapped O&M Amount” shall mean the Uncapped O&M Costs.

“Unrecovered Balance” shall mean for the New Approved Capital Improvement Costs incurred in any prior Fiscal Year, an amount equal to difference between (i) those New Approved Capital Improvement Costs in such Fiscal Year and (ii) the aggregate Capital Recovery Amount that has been paid in the calculation of the Utility Fee in prior Fiscal Years that are attributable to such New Approved Capital Improvement Costs; *plus* (iii) Breakage Costs (but not in the event of early termination of the Agreement pursuant to Section 16.1(b)(i) of the Agreement).

“Variable Fee Component” shall mean the sum of all Unrecovered Balances.

EXHIBIT A

CALCULATION OF UTILITY FEE²

$UF = COMA + (IMPROE \times IMPFGF \times IMPVFC) + (IMPCOD \times IMPSGF \times IMPVFC) + (CIROE \times FGF \times VFC) + (CICOD \times SGF \times VFC) + CRA + UOMA$

CICOD = CI Cost of Debt Factor

CIROE = CI Return on Equity Factor

COMA = Capped O&M Amount

CRA = Capital Recovery Amount

IMPCOD = IMP Cost of Debt Factor

IMPFGF = First Gearing Factor applicable to the Initial Modernization Project

IMPROE = IMP Return on Equity Factor

IMPSGF = Second Gearing Factor applicable to the Initial Modernization Project

IMPVFC – Variable Fee Component allocable to the Initial Modernization Project

FGF = First Gearing Factor applicable to Capital Improvements that are not the Initial Modernization Project

SGF = Second Gearing Factor applicable to Capital Improvements that are not the Initial Modernization Project

UF = Utility Fee

UOMA = Uncapped O&M Costs

VFC = Variable Fee Component not allocable to the Initial Modernization Project

Exemplar

As an exemplar only to illustrate a portion of the calculation of the Utility Fee, below shows the calculation for clauses (iv) and (v) of the Utility Fee formula and the Capital Recovery Amount for Fiscal Years 2023, 2024 and 2025, assuming that (a) \$1,000,000 is incurred as a New Approved Capital Improvement Cost in Fiscal Year 2022 for a New Approved Capital Improvement with a Recovery Period of 20 years with no further New Approved Capital Improvement Costs in 2023, 2024 and 2025, (b) the CI Return on Equity Factor is 0.10, (c) the First Gearing Factor is 0.1, (d)

² **CenTrio Note to Draft:** The example will need to be updated after the parties have agreed to the final version of this Schedule 5.

the CI Cost of Debt Factor is 0.033, and (e) the Second Gearing Factor is 0.9. For the avoidance of doubt, the above assumptions and below exemplar disregard the Initial Modernization Project, and none of these assumptions shall be binding on UMLLC or the Concessionaire, and they are not intended to reflect any expectations of either Party or the actual calculation of the Utility Fee.

Fiscal Year 2022

Utility Fee clause (iv) = \$0, calculated as follows: $0.1 \times 0.1 \times \$0$

Utility Fee clause (v) = \$0, calculated as follows: $0.033 \times 0.9 \times \0

Capital Recovery Amount = \$0

Fiscal Year 2023

Utility Fee clause (iv) = \$10,000, calculated as follows: $0.1 \times 0.1 \times (\$1,000,000 - \$0)$

Utility Fee clause (v) = \$29,700, calculated as follows: $0.033 \times 0.9 \times (\$1,000,000 - \$0)$

Capital Recovery Amount = \$50,000, calculated as follows: $\$1,000,000 / 20$

Fiscal Year 2024

Utility Fee clause (iv) = \$9,500, calculated as follows: $0.1 \times 0.1 \times (\$1,000,000 - \$50,000)$

Utility Fee clause (v) = \$28,215, calculated as follows: $0.033 \times 0.9 \times (\$1,000,000 - \$50,000)$

Capital Recovery Amount = \$50,000, calculated as follows: $\$1,000,000 / 20$

DRAFT

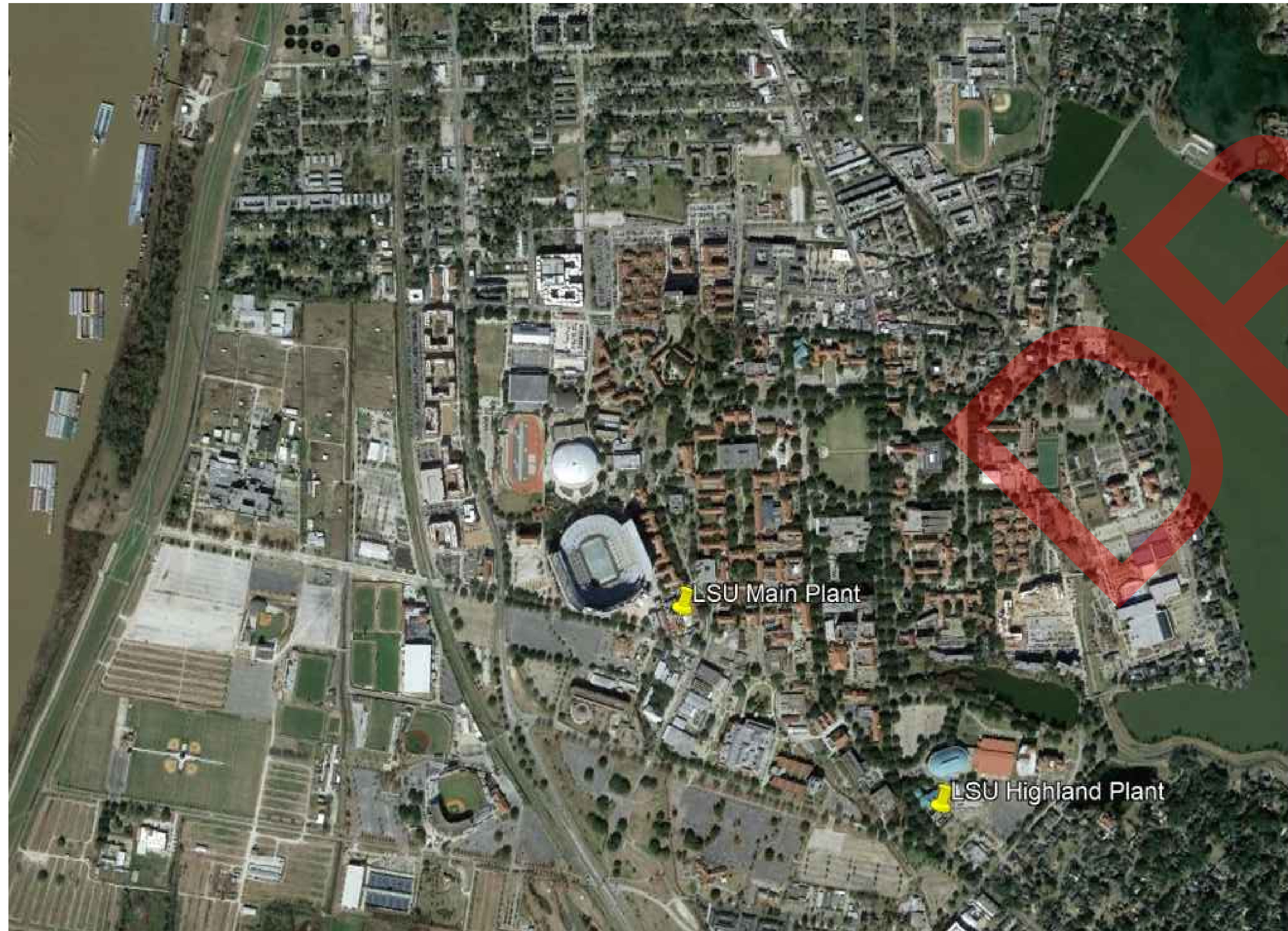

LSU - SHEET LIST		
SHEET NUMBER	SHEET TITLE	30% DESIGN REVIEW 09/17/21
G000	COVER	X
G310	HIGHLAND PLANT - FLOOR PLAN - GENERAL DEMOLITION	X
G320	HIGHLAND PLANT - FLOOR PLAN - GENERAL	X
S110	MAIN PLANT - OVERALL FLOOR PLAN - STRUCTURAL DEMOLITION	X
S111	MAIN PLANT - TOWER YARD - STRUCTURAL DEMOLITION	X
S120	MAIN PLANT - OVERALL FLOOR PLAN - STRUCTURAL	X
S121	MAIN PLANT - TOWER YARD - STRUCTURAL	X
S122	MAIN PLANT - MAIN CHILLER FLOOR PLAN - STRUCTURAL	X
S310	HIGHLAND PLANT - FLOOR PLAN - STRUCTURAL DEMOLITION	X
S320	HIGHLAND PLANT - FLOOR PLAN - STRUCTURAL	X
S321	HIGHLAND PLANT - ROOF PLAN - STRUCTURAL	X
M000	LEGEND AND GENERAL NOTES - MECHANICAL	X
M110	MAIN PLANT - OVERALL FLOOR PLAN - MECHANICAL DEMOLITION	X
M120	MAIN PLANT - OVERALL FLOOR PLAN - MECHANICAL	X
M210	CAMPUS CHILLED WATER DISTRIBUTION - OVERALL CAMPUS PLAN - MECHANICAL DEMOLITION	X
M211	CAMPUS CHILLED WATER DISTRIBUTION - SOUTHEAST LOOP PLAN - MECHANICAL DEMOLITION	X
M212	CAMPUS CHILLED WATER DISTRIBUTION - NORTH LOOP PLAN - MECHANICAL DEMOLITION	X
M213	CAMPUS CHILLED WATER DISTRIBUTION - EAST QUAD LOOP PLAN - MECHANICAL DEMOLITION	X
M220	CAMPUS CHILLED WATER DISTRIBUTION - OVERALL CAMPUS PLAN - MECHANICAL	X
M221	CAMPUS CHILLED WATER DISTRIBUTION - SOUTHEAST LOOP PLAN - MECHANICAL	X
M222	CAMPUS CHILLED WATER DISTRIBUTION - NORTH LOOP PLAN - MECHANICAL	X
M223	CAMPUS CHILLED WATER DISTRIBUTION - EAST QUAD LOOP PLAN - MECHANICAL	X
M310	HIGHLAND PLANT - FLOOR PLAN - MECHANICAL DEMOLITION	X
M320	HIGHLAND PLANT - FLOOR PLAN - MECHANICAL	X
M400	MAIN PLANT PRODUCTION - PIPING DIAGRAMS - CHILLED WATER - MECHANICAL DEMOLITION	X
M401	CAMPUS DISTRIBUTION - PIPING DIAGRAMS - CHILLED WATER - MECHANICAL DEMOLITION	X
M402	HIGHLAND PLANT PRODUCTION - PIPING DIAGRAMS - CHILLED WATER - MECHANICAL DEMOLITION	X
M403	SOUTHEAST LOOP DISTRIBUTION - PIPING DIAGRAMS - CHILLED WATER - MECHANICAL DEMOLITION	X
M404A	NORTHWEST LOOP DISTRIBUTION - PIPING DIAGRAMS - CHILLED WATER - MECHANICAL DEMOLITION - OPTION A	X
M404B	NORTHWEST LOOP DISTRIBUTION - PIPING DIAGRAMS - CHILLED WATER - MECHANICAL DEMOLITION - OPTION B	X
M405	EAST QUAD LOOP DISTRIBUTION - PIPING DIAGRAMS - CHILLED WATER - MECHANICAL DEMOLITION	X
M410	MAIN PLANT PRODUCTION - PIPING DIAGRAMS - CHILLED WATER - MECHANICAL	X
M411	CAMPUS DISTRIBUTION - PIPING DIAGRAMS - CHILLED WATER - MECHANICAL	X
M412	HIGHLAND PLANT PRODUCTION - PIPING DIAGRAMS - CHILLED WATER - MECHANICAL	X
M413	SOUTHEAST LOOP DISTRIBUTION - PIPING DIAGRAMS - CHILLED WATER - MECHANICAL	X
M414A	NORTHWEST LOOP DISTRIBUTION - PIPING DIAGRAMS - CHILLED WATER - MECHANICAL - OPTION A	X
M414B	NORTHWEST LOOP DISTRIBUTION - PIPING DIAGRAMS - CHILLED WATER - MECHANICAL - OPTION B	X
M415	EAST QUAD LOOP DISTRIBUTION - PIPING DIAGRAMS - CHILLED WATER - MECHANICAL	X
M420	MAIN PLANT - PIPING DIAGRAMS - TOWER WATER - MECHANICAL DEMOLITION	X
M421	MAIN PLANT - PIPING DIAGRAMS - TOWER WATER CONT. - MECHANICAL DEMOLITION	X
M422	HIGHLAND PLANT - PIPING DIAGRAMS - TOWER WATER - MECHANICAL DEMOLITION	X
M430	MAIN PLANT - PIPING DIAGRAMS - TOWER WATER - MECHANICAL	X
M431	MAIN PLANT - PIPING DIAGRAMS - TOWER WATER CONT. - MECHANICAL	X
M432	HIGHLAND PLANT - PIPING DIAGRAMS - TOWER WATER - MECHANICAL	X
M440	HIGHLAND PLANT - PIPING DIAGRAMS - HEATING WATER - MECHANICAL	X
ATC001	CONTROLS LEGEND	X
ATC002	CONTROLS DETAILS 1	X
ATC003	CONTROLS DETAILS 2	X
ATC004	CONTROLS DETAILS 3	X
ATC100	MAIN PLANT CHILLED WATER CONTROL DIAGRAM	X
ATC103	CAMPUS CHILLED WATER DISTRIBUTION CONTROL DIAGRAM	X
ATC106	HIGHLAND PLANT CHILLED WATER CONTROL DIAGRAM	X
ATC200	MAIN PLANT TOWER WATER CONTROL DIAGRAM	X
ATC201	MAIN PLANT TOWER WATER CONTROL DIAGRAM CONT.	X
ATC202	HIGHLAND PLANT TOWER WATER CONTROL DIAGRAM	X
ATC203	MAIN PLANT TOWER WATER CONTROL SCHEDULES AND DETAILS	X
ATC300	HIGHLAND PLANT TOWER WATER CONTROL SCHEDULES AND DETAILS	X
ATC301	MAIN PLANT STEAM CONTROL DIAGRAM	X
ATC302	MAIN PLANT CST & DA CONTROL DIAGRAM	X
ATC303	MAIN PLANT - PIPING DIAGRAMS - FEEDWATER - EXISTING	X
E000	LEGEND AND GENERAL NOTES - ELECTRICAL	X
E110	MAIN PLANT - OVERALL FLOOR PLAN - ELECTRICAL DEMOLITION	X
E120	MAIN PLANT - OVERALL FLOOR PLAN - ELECTRICAL	X
E310	HIGHLAND PLANT - FLOOR PLAN - ELECTRICAL DEMOLITION	X
E320	HIGHLAND PLANT - FLOOR PLAN - ELECTRICAL	X
E321	HIGHLAND PLANT - PDC SUBSTATION PLAN - ELECTRICAL	X
E400	MAIN PLANT - ONE-LINE DIAGRAM - ELECTRICAL DEMOLITION	X
E410	HIGHLAND PLANT - ONE-LINE DIAGRAM - ELECTRICAL DEMOLITION	X
E420	MAIN PLANT - ONE-LINE DIAGRAM - ELECTRICAL	X
E430	HIGHLAND PLANT - ONE-LINE DIAGRAM - ELECTRICAL	X

INITIAL MODERNIZATION SOLUTION
LOUISIANA STATE UNIVERSITY
LOUISIANA ENERGY PARTNERS
BATON ROUGE, LOUISIANA

MARK	DATE	DESCRIPTION
------	------	-------------

ISSUE DATE:	09/17/21
-------------	----------

PROJECT NUMBER:	70-19-0025
-----------------	------------

SHEET TITLE:

COVER

SHEET NUMBER:

G000

**PRELIMINARY
FOR REVIEW ONLY**

ENGINEER SEAL

**INITIAL MODERNIZATION SOLUTION
LOUISIANA STATE UNIVERSITY
LOUISIANA ENERGY PARTNERS
BATON ROUGE, LOUISIANA**

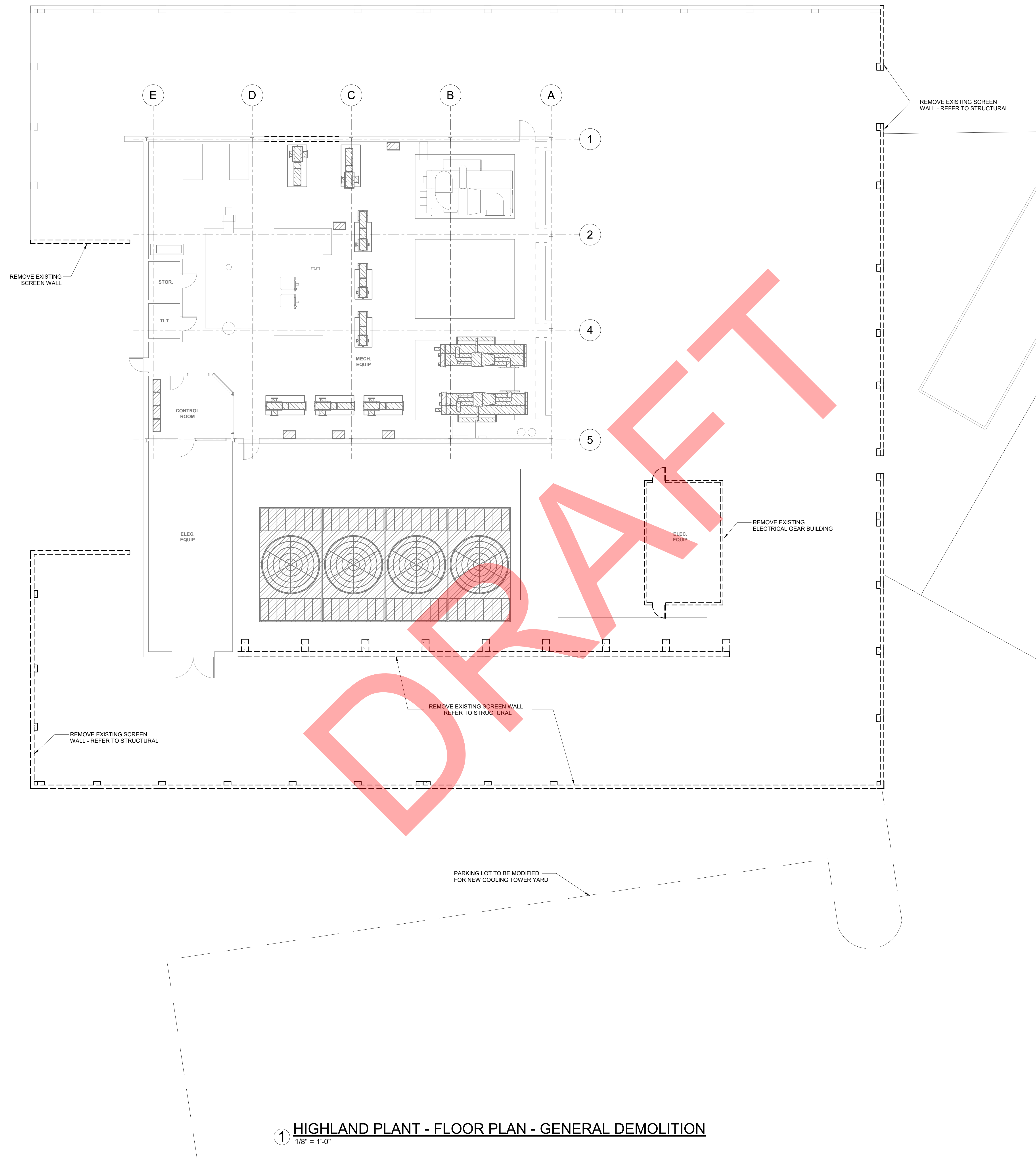

1 HIGHLAND PLANT - FLOOR PLAN - GENERAL DEMOLITION
1/8" = 1'-0"

MARK DATE DESCRIPTION

ISSUE DATE: 09/17/21

PROJECT NUMBER: 70-19-0025

SHEET TITLE:

HIGHLAND PLANT - FLOOR PLAN
- GENERAL DEMOLITION

SHEET NUMBER:

G310

**PRELIMINARY
FOR REVIEW ONLY**

ENGINEER SEAL

**INITIAL MODERNIZATION SOLUTION
LOUISIANA STATE UNIVERSITY
LOUISIANA ENERGY PARTNERS
BATON ROUGE, LOUISIANA**

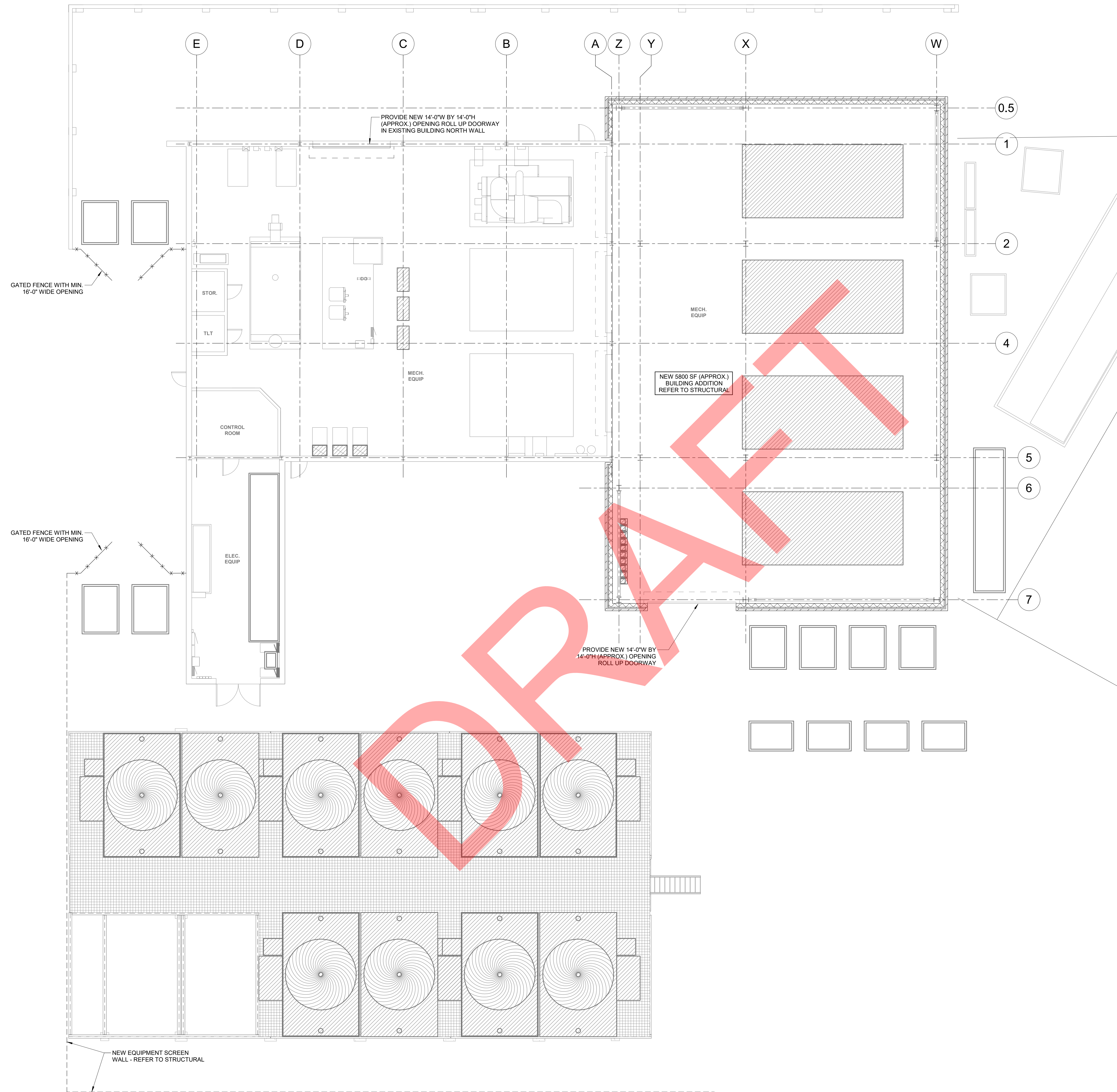

1 HIGHLAND PLANT - FLOOR PLAN - GENERAL
1/8" = 1'-0"

MARK	DATE	DESCRIPTION
ISSUE DATE:	09/17/21	
PROJECT NUMBER:	70-19-0025	
SHEET TITLE:		
HIGHLAND PLANT - FLOOR PLAN - GENERAL		
SHEET NUMBER:		
G320		

**PRELIMINARY
FOR REVIEW ONLY**

ENGINEER SEAL

**INITIAL MODERNIZATION SOLUTION
LOUISIANA STATE UNIVERSITY
LOUISIANA ENERGY PARTNERS
BATON ROUGE, LOUISIANA**

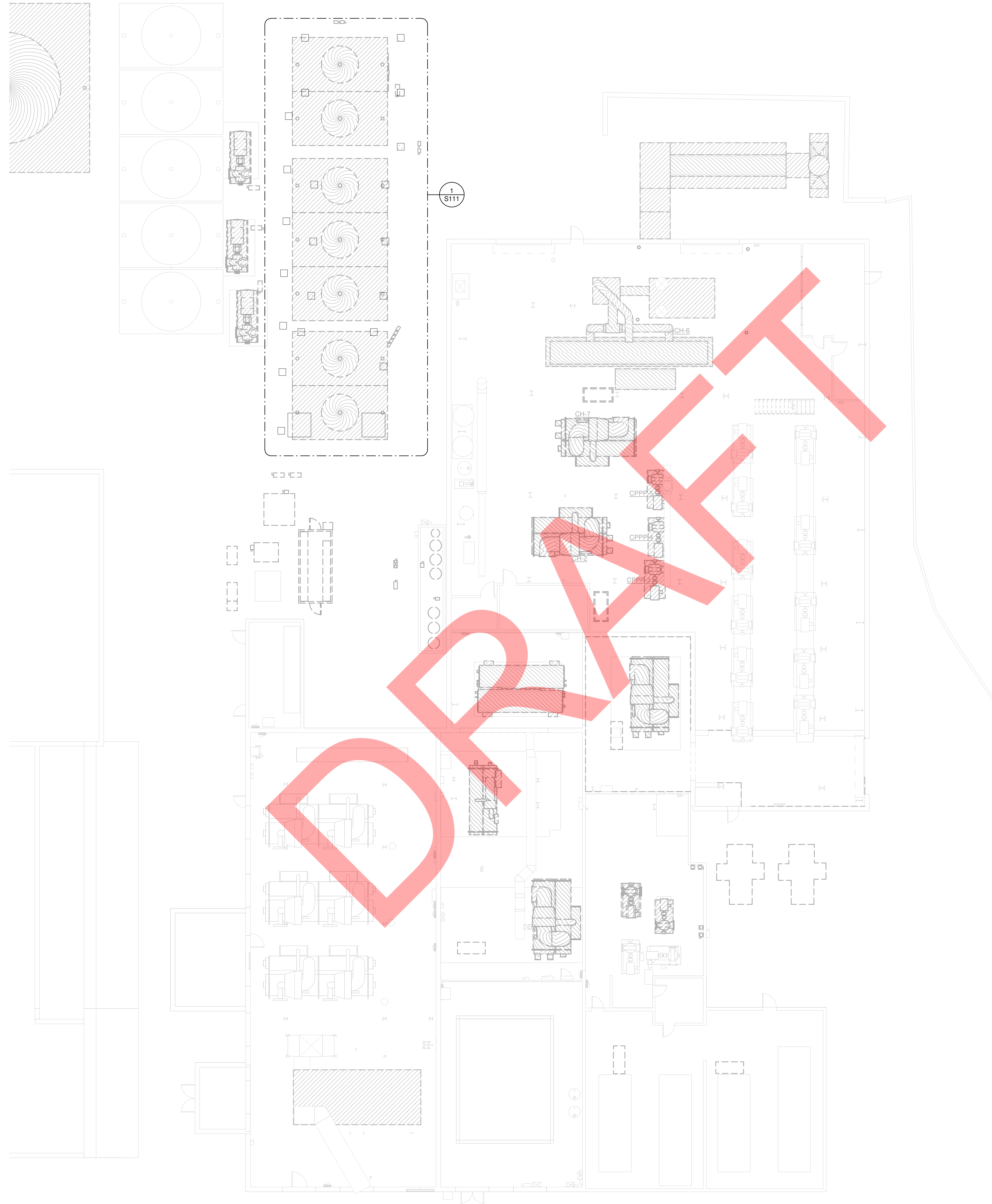

1 MAIN PLANT - OVERALL FLOOR PLAN - STRUCTURAL DEMOLITION
3/32" = 1'-0"

MARK	DATE	DESCRIPTION
------	------	-------------

ISSUE DATE:	09/17/21
-------------	----------

PROJECT NUMBER:	70-19-0025
-----------------	------------

SHEET TITLE:
MAIN PLANT - OVERALL FLOOR
PLAN - STRUCTURAL
DEMOLITION

SHEET NUMBER:

S110

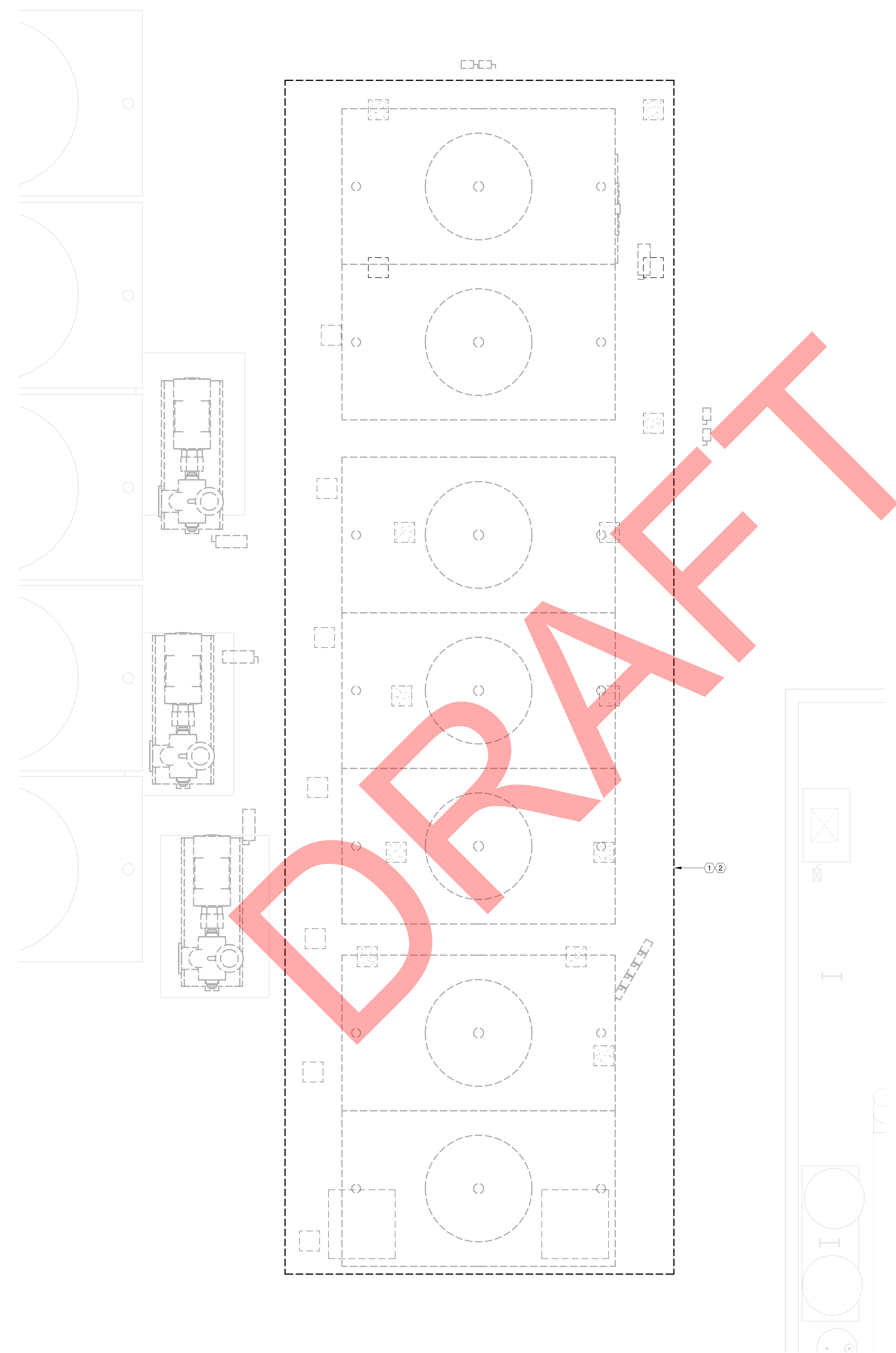

1 MAIN PLANT - TOWER YARD - STRUCTURAL DEMOLITION
1/4" = 1'-0"

- DEMOLITION KEYED NOTES:**
- ① REMOVE CONCRETE FOUNDATIONS AS REQ'D (PEDESTALS AND PIER CAPS) MIN OF 2'-0" BELOW FINISH GRADE
 - ② REMOVE ALL EXISTING COOLING TOWER SUPPORT FRAMING STEEL AND UNUSED PIPE STANDS

**PRELIMINARY
FOR REVIEW ONLY**

ENGINEER SEAL

**INITIAL MODERNIZATION SOLUTION
LOUISIANA STATE UNIVERSITY
LOUISIANA ENERGY PARTNERS
BATON ROUGE, LOUISIANA**

MARK	DATE	DESCRIPTION

ISSUE DATE: 09/17/21

PROJECT NUMBER: 70-19-0025

SHEET TITLE:
MAIN PLANT - TOWER YARD -
STRUCTURAL DEMOLITION

SHEET NUMBER:
S111

**PRELIMINARY
FOR REVIEW ONLY**

ENGINEER SEAL

**INITIAL MODERNIZATION SOLUTION
LOUISIANA STATE UNIVERSITY
LOUISIANA ENERGY PARTNERS
BATON ROUGE, LOUISIANA**

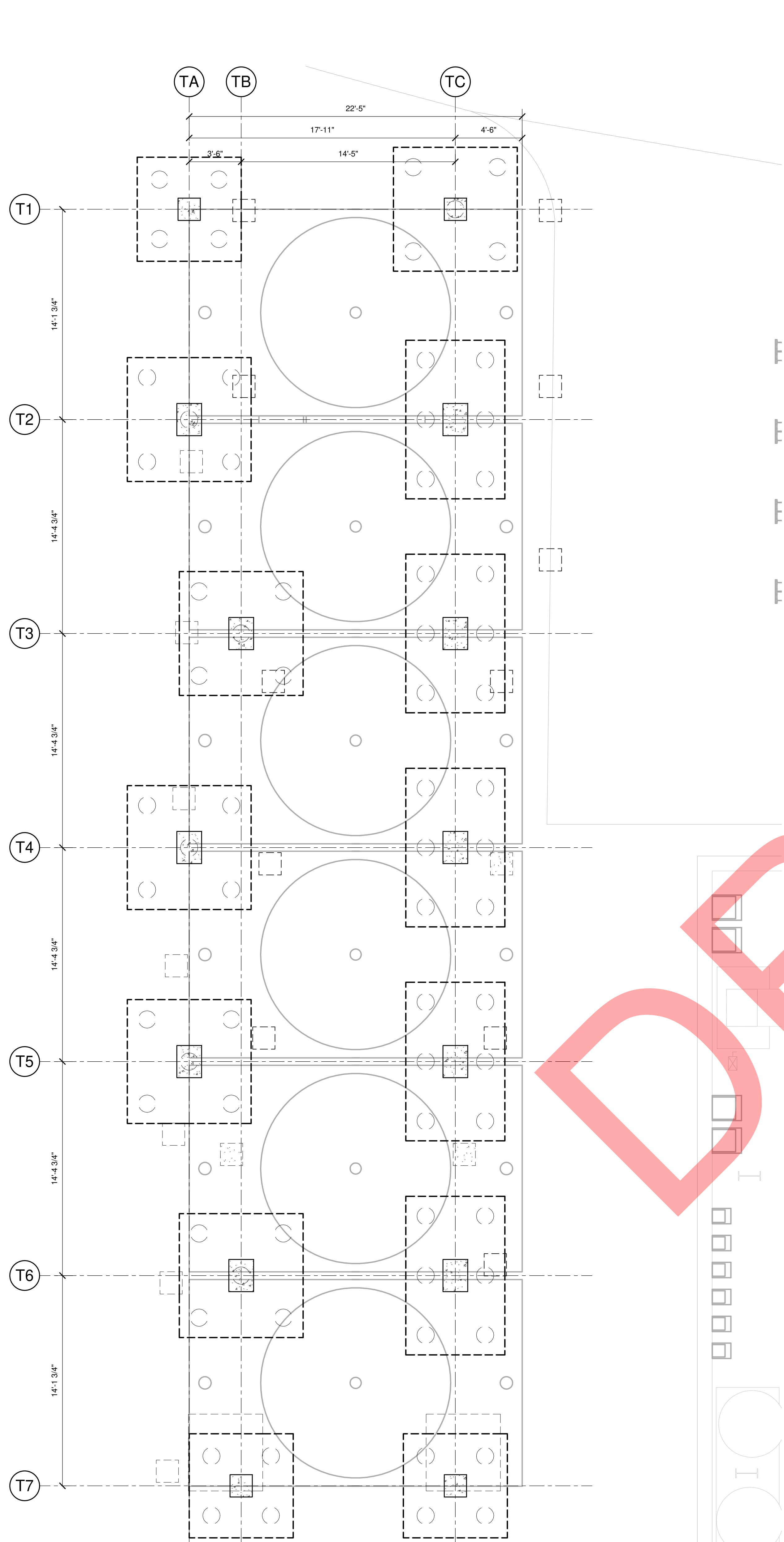

1 MAIN PLANT - TOWER YARD FOUNDATION - STRUCTURAL
1/4" = 1'-0"

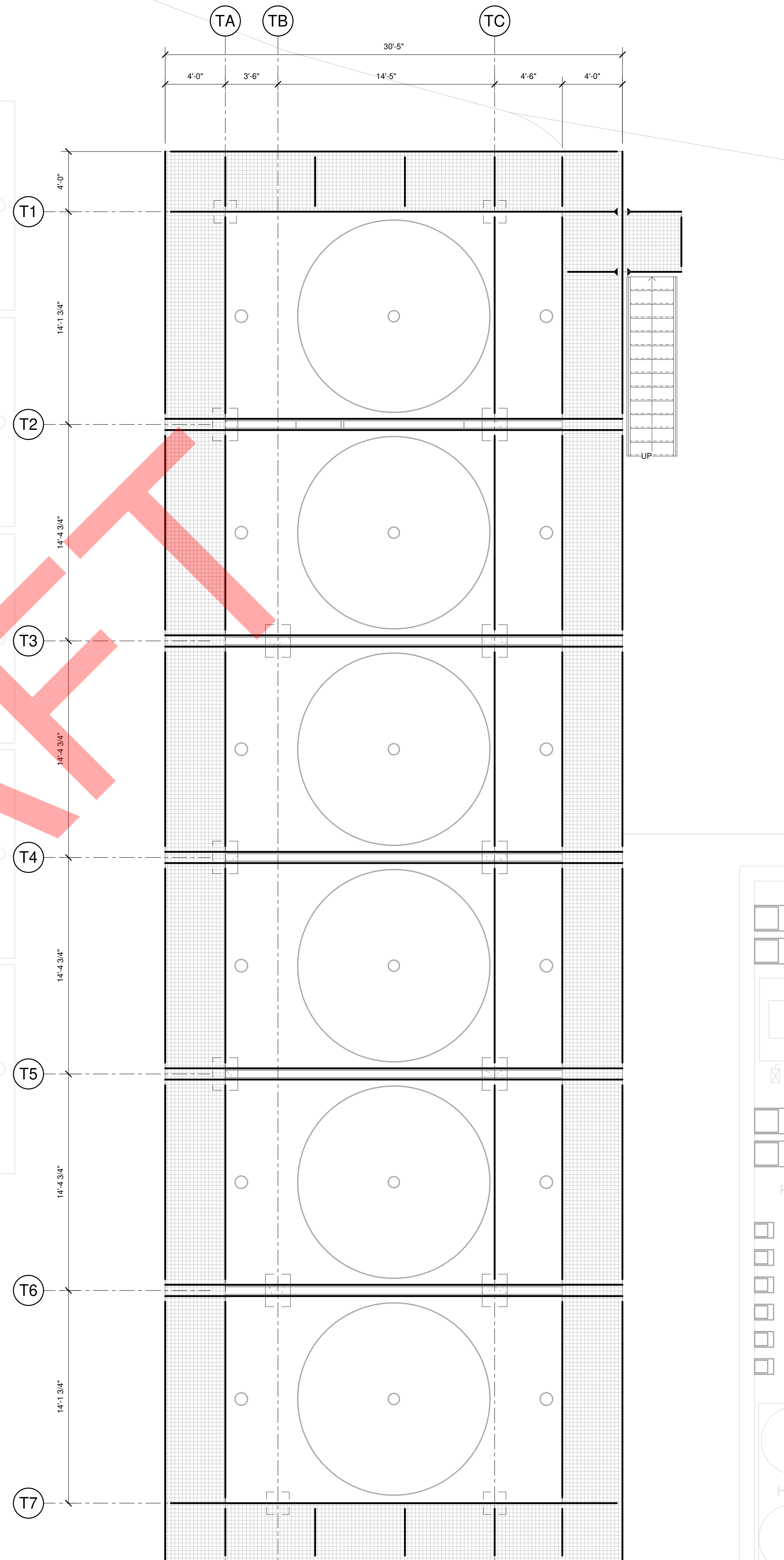

2 MAIN PLANT - TOWER YARD FRAMING - STRUCTURAL
1/4" = 1'-0"

MARK	DATE	DESCRIPTION
ISSUE DATE:	09/16/21	
PROJECT NUMBER:	70-19-0025	
SHEET TITLE:		
MAIN PLANT - TOWER YARD - STRUCTURAL		
SHEET NUMBER:		
S121		

**PRELIMINARY
FOR REVIEW ONLY**

ENGINEER SEAL

**INITIAL MODERNIZATION SOLUTION
LOUISIANA STATE UNIVERSITY
LOUISIANA ENERGY PARTNERS**
BATON ROUGE, LOUISIANA

MARK	DATE	DESCRIPTION

ISSUE DATE: 09/17/21

PROJECT NUMBER: 70-19-0025

SHEET TITLE:
MAIN PLANT - MAIN CHILLER
FLOOR PLAN - STRUCTURAL

SHEET NUMBER:
S122

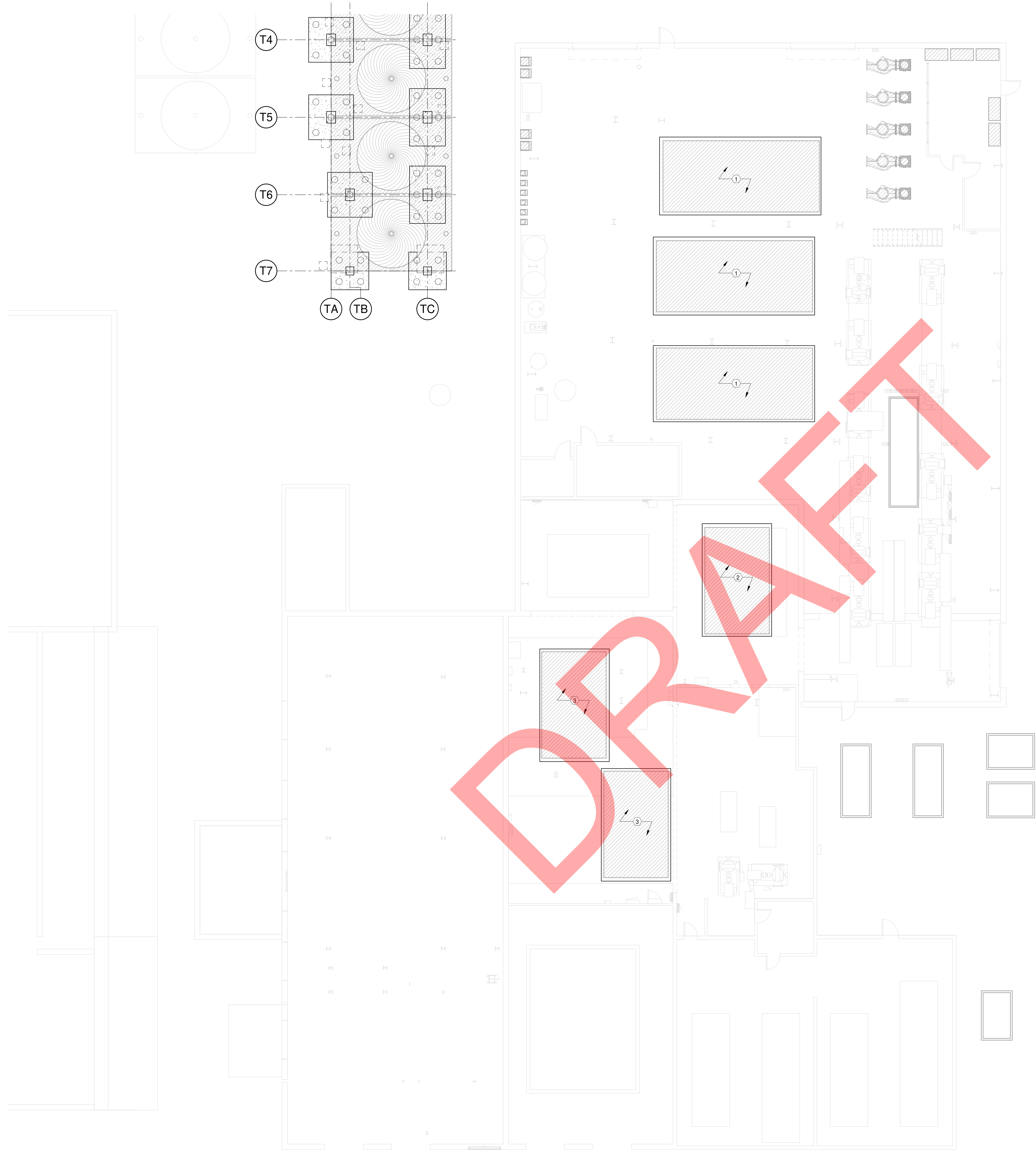

- KEYED NOTES:**
- ① NEW CHILLER HOUSEKEEPING PAD
 - ② EXTEND PAD AS REQ'D FOR NEW CHILLER
 - ③ EXTEND PAD AS REQ'D FOR NEW CHILLER AND REINF ELEVATED SLAB WITH POST AND FOOTINGS BELOW.

1 MAIN PLANT - MAIN CHILLER FLOOR PLAN - STRUCTURAL
1/8" = 1'-0"

**PRELIMINARY
FOR REVIEW ONLY**

ENGINEER SEAL

**INITIAL MODERNIZATION SOLUTION
LOUISIANA STATE UNIVERSITY
LOUISIANA ENERGY PARTNERS
BATON ROUGE, LOUISIANA**

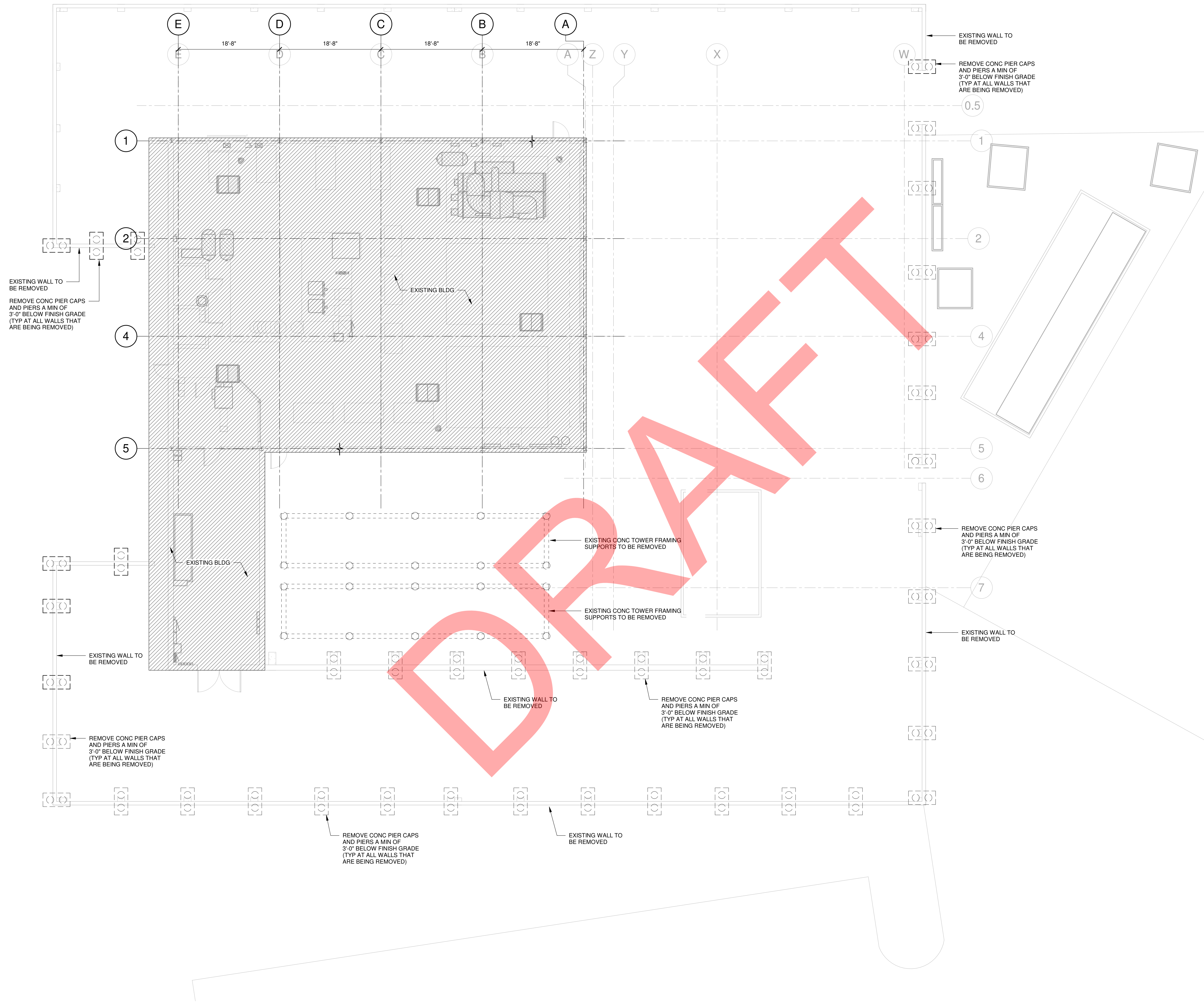

1 HIGHLAND PLANT - FLOOR PLAN - STRUCTURAL DEMOLITION
1/8" = 1'-0"

MARK	DATE	DESCRIPTION
ISSUE DATE:	09/17/21	
PROJECT NUMBER:	70-19-0025	
SHEET TITLE:		
HIGHLAND PLANT - FLOOR PLAN - STRUCTURAL DEMOLITION		
SHEET NUMBER:		
S310		

**PRELIMINARY
FOR REVIEW ONLY**

ENGINEER SEAL

**INITIAL MODERNIZATION SOLUTION
LOUISIANA STATE UNIVERSITY
LOUISIANA ENERGY PARTNERS**
BATON ROUGE, LOUISIANA

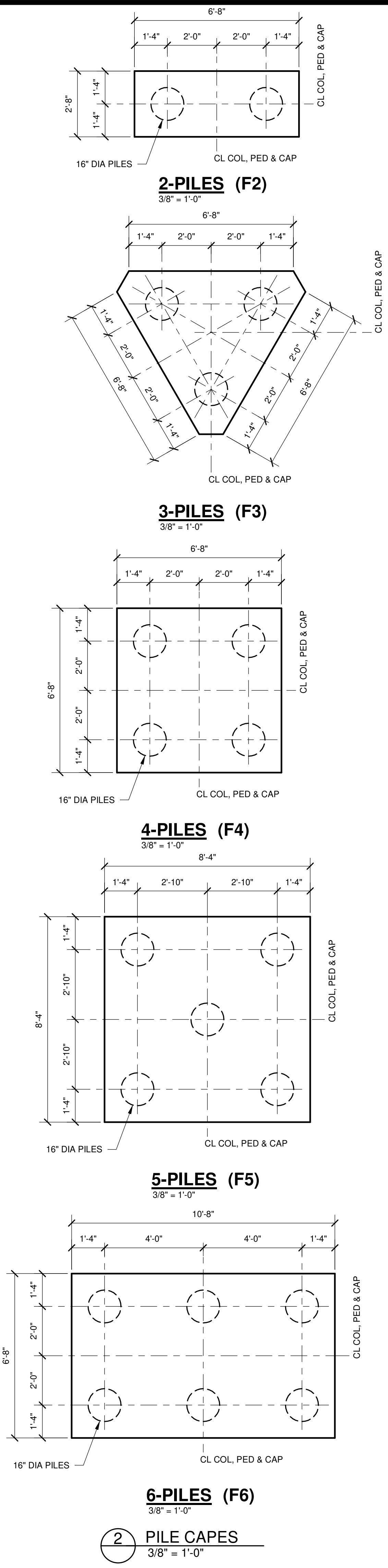

PILE CAP SCHEDULE			
MARK	SIZE L x W x H	REINFORCING	
		LONG BARS	SHORT BARS
F2	6'-8" x 2'-8" x 3'-3"	8-#5H	5-#4H
F3	6'-8" x 6'-8" x 6'-8" x 2'-9"	7-#5 BARS (3 WAYS)	
F4	6'-8" x 6'-8" x 2'-10"	13-#6H	13-#6H
F5	8'-4" x 8'-4" x 3'-0"	17-#6H	17-#6H
F6	10'-8" x 6'-8" x 3'-9"	18-#6H	20-#6H

NOTES:
1. 1" HOOK BOTH ENDS OF ALL BARS 180 DEGREES
2. WHERE HOOKED BARS REQUIRED ONE DIRECTION ONLY PLACE AS BOTTOM LAYER.

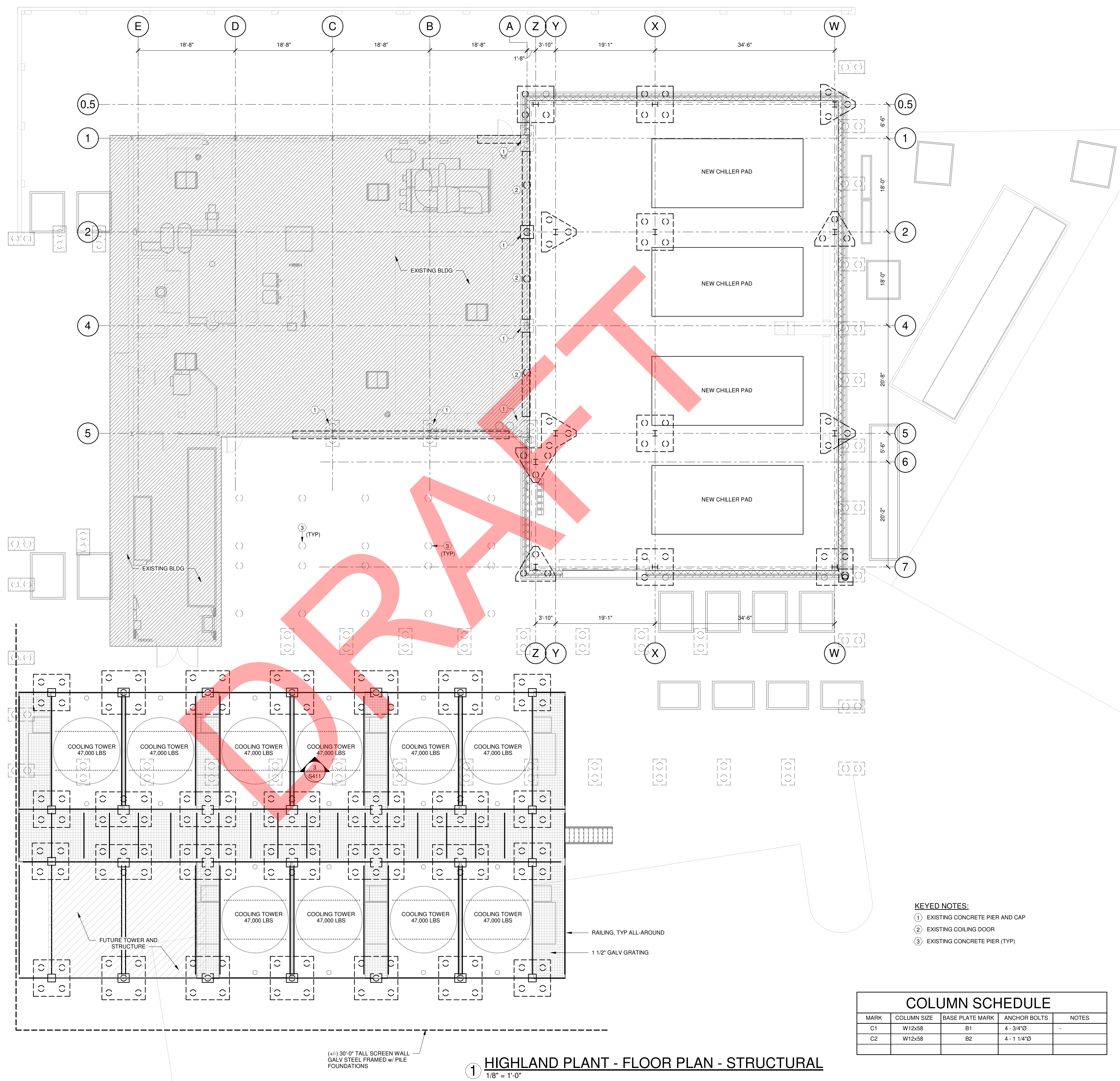

KEYED NOTES:
① EXISTING CONCRETE PIER AND CAP
② EXISTING COILING DOOR
③ EXISTING CONCRETE PIER (TYP)

COLUMN SCHEDULE				
MARK	COLUMN SIZE	BASE PLATE MARK	ANCHOR BOLTS	NOTES
C1	W12x58	B1	4 - 3/4"Ø	
C2	W12x58	B2	4 - 1 1/4"Ø	

1 HIGHLAND PLANT - FLOOR PLAN - STRUCTURAL
1/8" = 1'-0"

MARK	DATE	DESCRIPTION
ISSUE DATE:	09/17/21	
PROJECT NUMBER:	70-19-0025	
SHEET TITLE:		
HIGHLAND PLANT - FLOOR PLAN - STRUCTURAL		
SHEET NUMBER:		
S320		

**PRELIMINARY
FOR REVIEW ONLY**

ENGINEER SEAL

**INITIAL MODERNIZATION SOLUTION
LOUISIANA STATE UNIVERSITY
LOUISIANA ENERGY PARTNERS**
BATON ROUGE, LOUISIANA

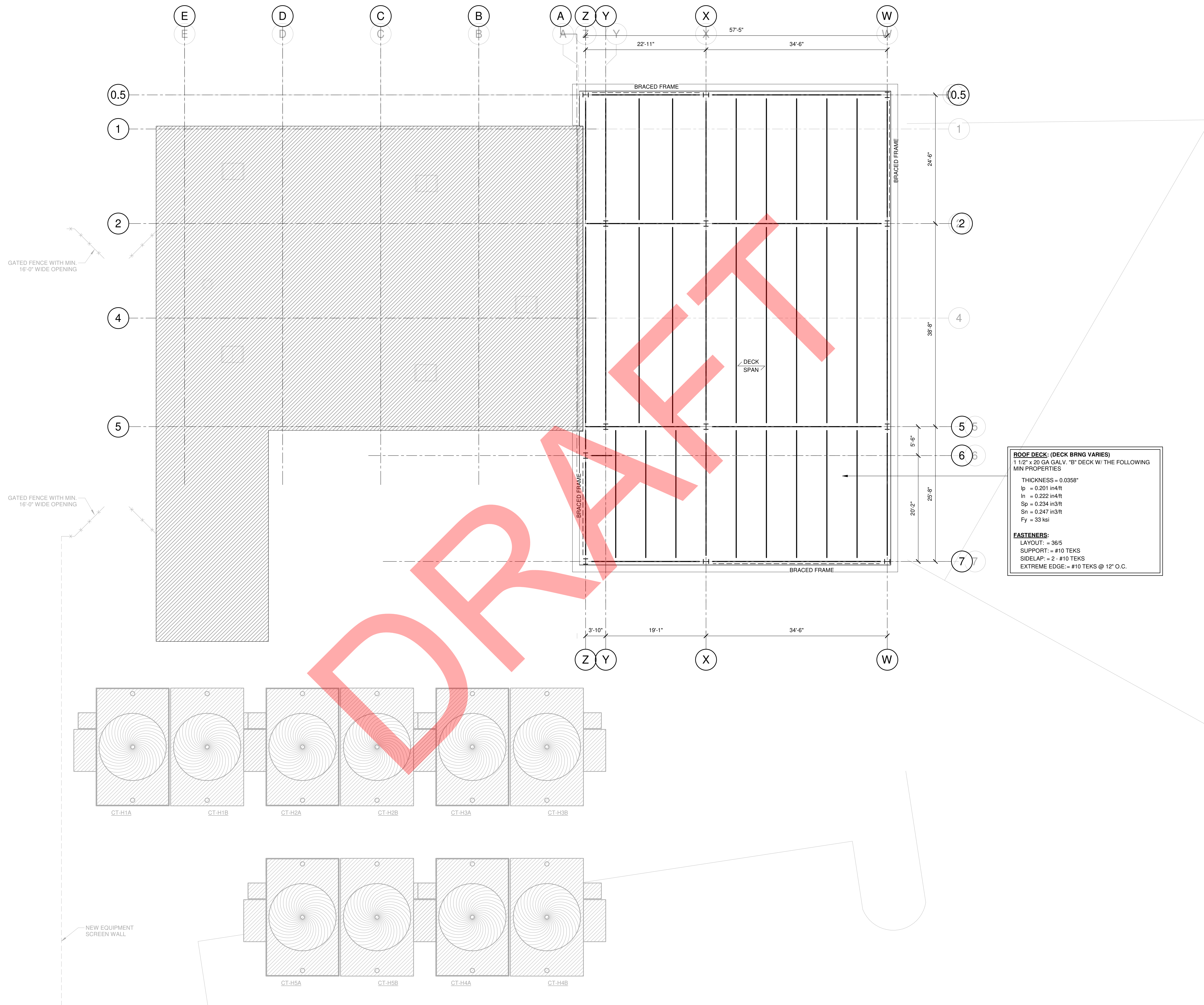

ROOF DECK: (DECK BRNG VARIES)
1 1/2" x 20 GA GALV. "B" DECK W/ THE FOLLOWING
MIN PROPERTIES

THICKNESS = 0.0358"
 Ip = 0.201 in⁴/ft
 In = 0.222 in⁴/ft
 Sp = 0.234 in³/ft
 Sh = 0.247 in³/ft
 Fy = 33 ksi

FASTENERS:
 LAYOUT: = 36/6
 SUPPORT: = #10 TEKS
 SIDELAP: = 2 - #10 TEKS
 EXTREME EDGE: = #10 TEKS @ 12" O.C.

1 HIGHLAND PLANT - ROOF PLAN - STRUCTURAL
1/8" = 1'-0"

MARK	DATE	DESCRIPTION
ISSUE DATE:	09/17/21	
PROJECT NUMBER:	70-19-0025	
SHEET TITLE:		
HIGHLAND PLANT - ROOF PLAN - STRUCTURAL		
SHEET NUMBER:		
S321		

GENERAL ABBREVIATIONS

Table of general abbreviations including AFF (Above Finished Floor), APD (Air Pressure Drop), ATC (Automated Temperature Control), BHP (Brake Horsepower), BOB (Bottom of Beam), BOD (Bottom of Duct), BOP (Bottom of Pipe), BTUH (British Thermal Units per Hour), CFM (Cubic Feet per Minute), DB (Dry Bulb), DIA (Diameter), DN (Down), DTL (Detail), EA (Exhaust Air), EAT (Entering Air Temperature), EC (Electrical Contractor), ESP (External Static Pressure), EXH (Exhaust), FT (Feet), GA (Gauge), GAL (Gallons), GALV (Galvanized), GC (General Contractor), HP (Horsepower), HVAC (Heating, Ventilating & Air Conditioning), KW (Kilowatts), LAT (Leaving Air Temperature), MAX (Maximum), MBH (Thousands British Thermal Units per Hour), MIN (Minimum), NC (Normally Closed), NO (Normally Open), NTS (Not to Scale), OA (Outside Air), OF/CI (Owner Furnished / Contractor Installed), OPD (Opposed Blade Damper), PC (Plumbing Contractor), PD (Pressure Drop), RA (Return Air), RH (Relative Humidity), RM (Room), SA (Supply Air), SEN (Sensible), SP (Static Pressure), TFD (To Floor Drain), TS (Temperature Sensor), TSP (Total Static Pressure), TYP (Typical), UC (Undercut Door), UNO (Unless Noted Otherwise), V (Volts), VTR (Vent Thru Roof).

EQUIPMENT DESIGNATION

Table of equipment designations including AC (Air Curtain), AHU (Air Handling Unit), AF (Air Filter), AP (Access Panel), ADS (Air / Dirt Separator), B (Boiler), PMP (Pump), CU (Condensing Unit), DDC (Direct Digital Control), DP (Differential Pressure Switch), ERU (Energy Recovery Unit), EF (Exhaust Fan), EG (Exhaust Grille), EH (Electric Heater), ET (Expansion Tank or Exhaust Terminal), FD (Fire Damper), FEP (Field Equipment Panel), FSD (Combination Fire/Smoke Damper), FLA (Full Load Amps), H (Humidifier), L (Louver), MCA (Minimum Circuit Ampacity), RAF (Return Fan), RG (Return Grille), SD (Smoke Damper), SF (Supply Fan), SG (Supply Grille), ST (Supply Terminal), TG (Transfer Grille), UH (Unit Heater), VAV (Variable Air Volume Box), VD (Manual Volume Damper), VFD (Variable Frequency Drive).

ONE LINE PIPE SYMBOLS

Table of one line pipe symbols including symbols for supply from tower, return to tower, heating water supply, heating water return, chilled water supply, chilled water return, condensate drain, steam supply, steam return, pumped steam return, boiler feedwater, ball valve, butterfly valve, gate valve, OS & Y gate valve, globe valve, check valve, pressure reducing valve, flow limiting valve, calibrated balancing valve, valve at riser, strainer w/ drain valve, union, air terminal, and control valve (3-way) electric or electronic.

ONE LINE PIPE SYMBOLS

Table of one line pipe symbols including symbols for control valve (3-way) electric or electronic, control valve (2-way) pneumatic, emergency shut-off valve with fusible link, flexible pipe connector, metal bellows pump connector, air vent (A - Auto, H - Hand), pressure and temperature tap, pressure gauge, pressure gauge w/ siphon, thermometer w/ insertion well, anchor, pipe guide, flange, elbow, turned up, elbow, turned down, rise or drop in pipe, tee, side connection, tee, outlet up, tee, outlet down, capped outlet, capped pipe, concentric reducer, eccentric reducer, steam trap (drip leg), steam trap, direction of pitch, pipe to floor drain, and emergency management system insertion well.

TWO LINE PIPE SYMBOLS

Table of two line pipe symbols including symbols for elbow - flanged long radius 45°, elbow - flanged long radius 90°, elbow - welded long radius 45°, elbow - welded long radius 90°, end cap, flanges - slip on, flanges - weld neck, reducers - flanged concentric, reducers - flanged eccentric, reducers - welded concentric, reducers - welded eccentric, tee - flanged, tee - welded, butterfly valve - lever operator, butterfly valve - worm gear operator, butterfly valve - actuator, check valve - swing check, check valve - silent or wafer, gate valve - non rising stem, gate valve - outside stem and yoke, globe valve, strainer - Y, strainer - basket, suction diffuser, and flexible connectors.

DUCTWORK SYMBOLS

Table of ductwork symbols including symbols for thermostat, thermostat wiring, humidistat, temperature sensor, GPM fluid flow meter, supply air duct, return air duct, exhaust air duct, cubic feet per minute, energy management system, automatic temp controls, carbon dioxide, parts per million, round diameter, flat oval (major/minor), short (1x) radius ell, long (1.5x) radius ell, square ell, ell with turning vanes, streamline tap (rectangular), streamline tap (round), conical tap, straight tap, lateral tap, manual volume damper, motorized volume damper, fire damper (FD), vertical fire damper (FD), smoke damper, combination fire / smoke damper (FD/S), rectangular duct (width/depth), round duct offset, change in elevation (rise, fall), flexible duct, supply duct up, return duct up, exhaust duct up, supply duct down, return duct down, exhaust duct down, ceiling diffuser, return air grille, exhaust air grille, access panel, access panel in round or oval duct, type - thru - airflow, and type - airflow.

PLUMBING LEGEND

Table of plumbing legend symbols and descriptions, organized into two columns. Includes symbols for sanitary sewer, combination waste & vent, storm drain, grease waste, acid waste, acid vent, cold water, hot water, hot water return, tempered water, domestic water service, deionized water, distilled water, natural gas, medical gas, oxygen, nitrogen, compressed air, vacuum, lab air, lab vacuum, reverse osmosis water supply, and reverse osmosis water return.

PLUMBING DEMOLITION LEGEND

Table of plumbing demolition legend symbols and descriptions, including symbols for existing equipment to remain, existing piping to remain, equipment to be removed, existing piping to be removed, and termination of demolition.

GENERAL NOTES:

- 1. ALL WORK IS TO CONFORM TO THE CODES OUTLINED IN THE SPECIFICATIONS.
2. BY NECESSITY, THESE DRAWINGS REFLECT A SYSTEM DESIGNED AROUND SPECIFIC REFERENCE PRODUCTS...
3. ALL DRAWINGS ARE DIAGRAMMATIC AND INDICATE THE GENERAL ARRANGEMENTS OR GEOMETRIC RELATIONSHIPS OF EQUIPMENT AND SERVICES...
4. EXCEPT WHERE MODIFIED BY SPECIFIC NOTATION TO THE CONTRARY, IT SHALL BE UNDERSTOOD THAT THE INDICATION AND/OR DESCRIPTION OF ANY ITEM IN THE DRAWINGS OR SPECIFICATIONS OR BOTH, CARRIES WITH IT THE INSTRUCTION TO FURNISH AND INSTALL THE ITEM...
5. EXACT LOCATION OF ALL EQUIPMENT AND PIPING SHALL BE COORDINATED WITH OTHER TRADES...
6. ALL SYSTEMS SHALL BE INSTALLED AS PER SPECIFICATIONS AND GOVERNING CODES.
7. INFORMATION AND COMPONENTS SHOWN ON PIPING DIAGRAMS OR DETAILS, BUT NOT SHOWN ON PLANS, AND VICE-VERSA, SHALL BE PROVIDED AS IF EXPRESSLY REQUIRED BY BOTH.
8. CONTRACTOR SHALL BE RESPONSIBLE FOR COORDINATING ALL WORK WITH THAT OF OTHER TRADES, ELECTRICAL, STRUCTURAL, CIVIL, ETC.
9. REFER TO SPECIFICATIONS OR SCHEDULES ON DRAWINGS FOR ACCEPTABLE MANUFACTURERS AND MODELS OF PLUMBING FIXTURES AND EQUIPMENT...
10. PROVIDE CLEANOUTS IN ALL SANITARY, STORM DRAINAGE & OVERFLOW LINES...
11. PROVIDE PRESSURE REDUCERS IN WATER SUPPLY LINES TO KEEP PRESSURE BELOW 70 PSI AT ALL OUTLETS...
12. INSULATE ALL WATER LINES ABOVE FLOOR...
13. INSULATE ALL CONDENSATE LINES INSIDE BUILDING AS PER INSULATION REQUIREMENTS FOR COLD WATER LINE...
14. SLOPE ALL SANITARY AND STORM LINES ARE 1/4" PER FOOT FOR PIPES LESS THAN 3" IN DIAMETER...
15. SLEEVE AND SEAL ALL PIPE PENETRATIONS THRU RATED WALLS AND FLOORS...
16. PROVIDE WATER HAMMER ARRESTORS IN BRANCH WATER LINES AS REQUIRED BY GOOD PRACTICE...
17. PROVIDE STOP VALVES AT EVERY FIXTURE ON BOTH HOT AND COLD WATER SUPPLY LINES...
18. ALL PIPE DROPS FROM CEILING PLENUM TO BELOW FLOOR SHALL BE MADE IN FURR-OUTS AT COLUMNS...
19. EXISTING INFORMATION SHOWN WAS GATHERED FROM 'AS BUILT' DRAWINGS AND JOB SITE VISITS...
20. PROVIDE GAS COCK, DIRT LEG, AND UNION AT ALL FINAL CONNECTIONS OF GAS PIPING TO EQUIPMENT.
21. WHERE THIS SYMBOL OCCURS ON THE DRAWINGS, REFERENCE SHOULD BE MADE TO THE KEYED NOTES ON THAT SAME SHEET...
22. IN ALL AREAS SUBJECT TO FREEZING, WATER PIPING SHALL BE INSTALLED ON THE THERMAL SIDE OF THE INSULATION.
23. THE CONTRACTOR SHALL, PRIOR TO THE START OF ANY WORK UNDER THIS CONTRACT, VISIT JOB SITE TO VERIFY SIZE, ELEVATION, LOCATION, ETC. OF ANY EXISTING PIPING NOTED, SHOWN OR IMPLIED...
24. CUT WALLS, FLOORS OR CEILINGS AS REQUIRED TO INSTALL NEW PIPING...
25. NO STRUCTURAL MEMBERS MAY BE CUT OR MODIFIED WITHOUT THE WRITTEN PERMISSION OF THE STRUCTURAL ENGINEER.
26. WHEN EXISTING FIXTURES AND EQUIPMENT ARE REMOVED AND NOT REPLACED, REMOVE PIPING BACK TO MAIN AND CAP.
27. REWORK EXISTING WATER, SANITARY AND VENT PIPING AS REQUIRED TO INSTALL NEW EQUIPMENT.
28. EXISTING FLOOR DRAINS SHALL BE THOROUGHLY CLEANED AND BUFFED...
29. EXISTING PIPE TO WHICH NEW PIPE IS CONNECTED SHALL BE RODED, FLUSHED AND CLEANED FROM POINT OF CONNECTIONS TO MAIN OUTSIDE BUILDING.
30. REMOVE ALL EXISTING PIPING WHICH IS DEEMED INOPERABLE AS A RESULT OF THIS CONTRACT UNLESS SHOWN OR NOTED OTHERWISE.
31. LOCATION OF FLOOR DRAINS IN MECHANICAL ROOMS SHALL BE COORDINATED WITH MECHANICAL EQUIPMENT AND MECHANICAL CONTRACTOR.
32. THE CONTRACTOR SHALL OBTAIN AND PAY FOR ALL LICENSES, PERMITS, DOCUMENTS, FEES, SERVICES AND UTILITY FEES REQUIRED TO DO THE WORK OF THIS CONTRACT.
33. MAINTAIN A DISTANCE OF 25'-0" FROM A SANITARY VENT THROUGH THE ROOF AND AN 8" FREESTAIR AIR INTAKE.
34. ALL PIPING IS TO BE CONCEALED UNLESS NOTED OTHERWISE. ALL EXPOSED PIPING IS TO BE CHROMIUM PLATED.
35. PROVIDE BACKFLOW PREVENTERS OR ANTI-SIPHON DEVICES AT ALL LOCATIONS WHERE THERE IS A POSSIBILITY OF CROSS CONTAMINATION.
36. MAKE ALL UTILITY CONNECTIONS AND INSTALLATIONS IN FULL ACCORDANCE WITH ALL UTILITY REGULATIONS...
37. MAINTAIN ALL MANUFACTURER'S RECOMMENDED SERVICE CLEARANCES FOR ALL FIXTURES AND EQUIPMENT...
38. CUTTING OF ROOF AND FLASHING OF PIPE CURBS, SANITARY VENT THROUGH ROOF, ETC. SHALL BE COORDINATED WITH AND PERFORMED BY THE ROOFING CONTRACTOR...
39. ALL ABOVE GRADE HORIZONTAL PIPING SHALL BE INSTALLED AS HIGH AS POSSIBLE...
40. ALL LOCATIONS OF EXISTING EQUIPMENT, DUCTWORK, ACCESSORIES, ETC. ARE APPROXIMATE...
41. INTERRUPTION OF BUILDING SERVICES AND UTILITIES SHOULD BE MINIMIZED WHEN POSSIBLE AND COORDINATED WITH OWNER.
42. THE CONTRACTOR IS RESPONSIBLE FOR REPAIRING ANY DAMAGE TO THE EXISTING BUILDING, EQUIPMENT AND SYSTEMS RESULTING FROM CONSTRUCTION.
43. REFER TO PIPING DIAGRAM FOR EXTENT OF WORK...
44. PRIOR TO CONNECTING ANY EXISTING SYSTEM TO THE NEW DISTRICT SYSTEM, CHEMICALLY TEST AND OBSERVE WATER QUALITY (TURBIDITY) OF THE EXISTING SYSTEM...

DEMOLITION AND RENOVATION SYMBOLS

Table of demolition and renovation symbols including symbols for equipment to be removed, existing equipment, new equipment, point of connection to existing, termination of demolition, duct to be removed, existing duct to remain, new duct, piping to be removed, existing piping to remain, and new piping.

PRELIMINARY FOR REVIEW ONLY

ENGINEER SEAL

INITIAL MODERNIZATION SOLUTION
LOUISIANA STATE UNIVERSITY
LOUISIANA ENERGY PARTNERS
BATON ROUGE, LOUISIANA

Table with columns: MARK, DATE, DESCRIPTION. Includes rows for ISSUE DATE (09/17/21), PROJECT NUMBER (70-19-0025), SHEET TITLE (LEGEND AND GENERAL NOTES - MECHANICAL), and SHEET NUMBER (M000).

SHEET NUMBER:

M000

**PRELIMINARY
FOR REVIEW ONLY**

ENGINEER SEAL

**INITIAL MODERNIZATION SOLUTION
LOUISIANA STATE UNIVERSITY
LOUISIANA ENERGY PARTNERS
BATON ROUGE, LOUISIANA**

GENERAL NOTES:

1. REMOVE AND DISPOSE OF IDENTIFIED EQUIPMENT. ASSOCIATED EQUIPMENT POWER AND CONTROLS TO BE REMOVED COMPLETELY. REFER TO ELECTRICAL.

KEYED NOTES:

1. BOILER 4 (B-4) TO BE REFURBISHED TO INCREASE STEAM PRODUCTION.

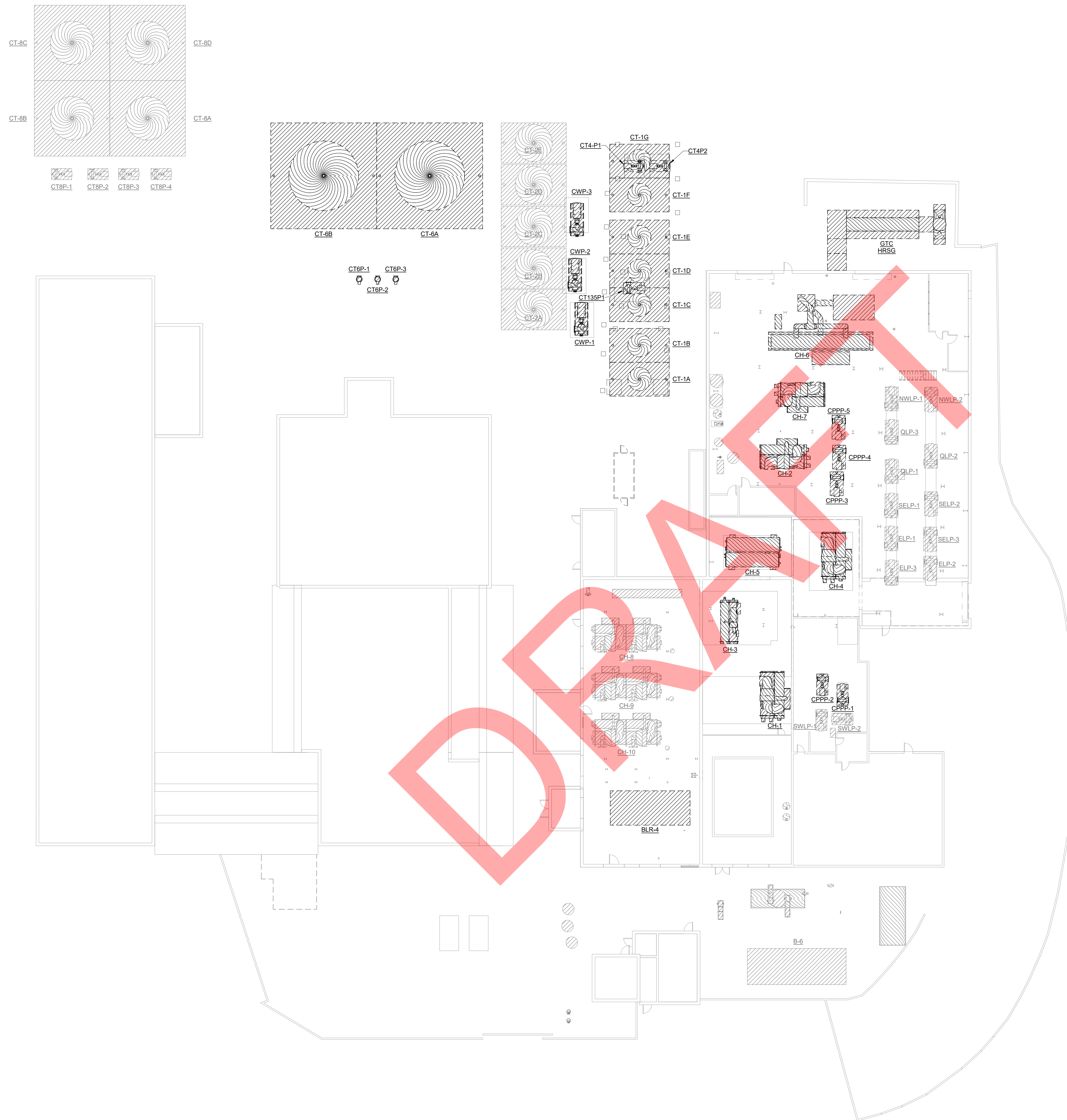

1 MAIN PLANT - OVERALL FLOOR PLAN - MECHANICAL DEMOLITION
1/16" = 1'-0"

MARK | DATE | DESCRIPTION

ISSUE DATE: 09/17/21

PROJECT NUMBER: 70-19-0025

SHEET TITLE:
MAIN PLANT - OVERALL FLOOR
PLAN - MECHANICAL
DEMOLITION

SHEET NUMBER:

M110

PRELIMINARY
FOR REVIEW ONLY

ENGINEER SEAL

**INITIAL MODERNIZATION SOLUTION
LOUISIANA STATE UNIVERSITY
LOUISIANA ENERGY PARTNERS**
BATON ROUGE, LOUISIANA

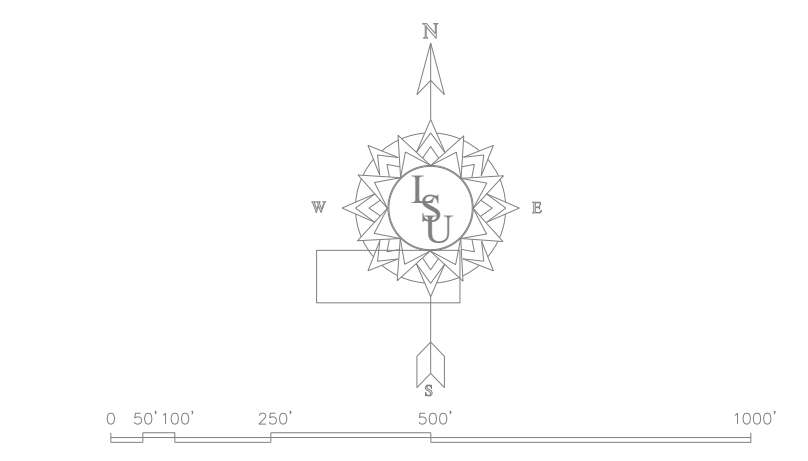
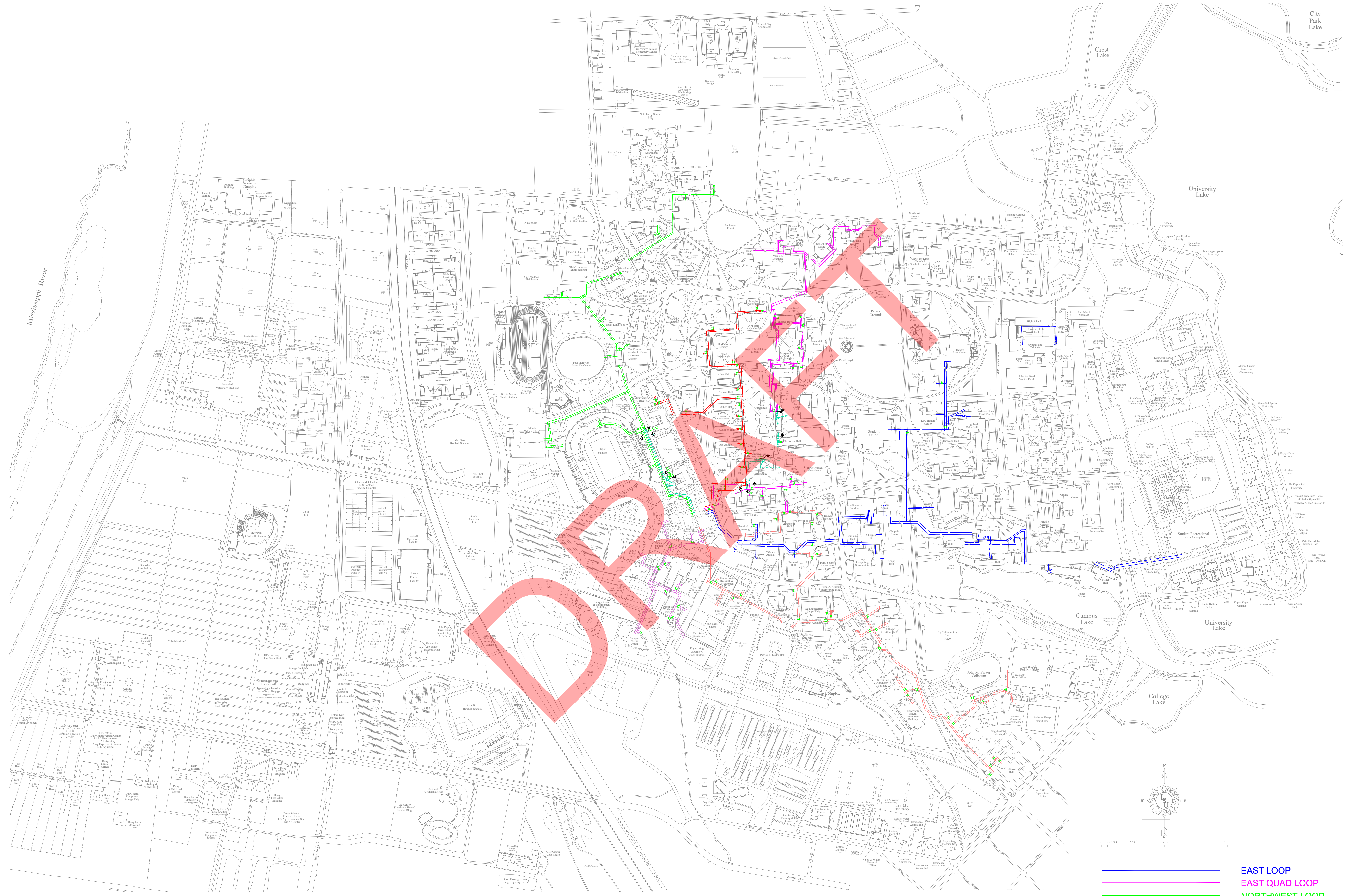

- EAST LOOP
- EAST QUAD LOOP
- NORTHWEST LOOP
- SOUTHEAST LOOP
- SOUTHWEST LOOP
- WEST QUAD LOOP
- - - DEMOLITION

1 CAMPUS CHILLED WATER DISTRIBUTION - OVERALL CAMPUS PLAN - MECHANICAL DEMOLITION
SCALE: 1"=300'-0"

MARK	DATE	DESCRIPTION
ISSUE DATE:	09/17/21	
PROJECT NUMBER:	70-19-0025	

SHEET TITLE:
CAMPUS CHILLED WATER
DISTRIBUTION - OVERALL
CAMPUS PLAN -
MECHANICAL DEMOLITION

SHEET NUMBER:
M210

PRELIMINARY
FOR REVIEW ONLY

ENGINEER SEAL

**INITIAL MODERNIZATION SOLUTION
LOUISIANA STATE UNIVERSITY
LOUISIANA ENERGY PARTNERS**
BATON ROUGE, LOUISIANA

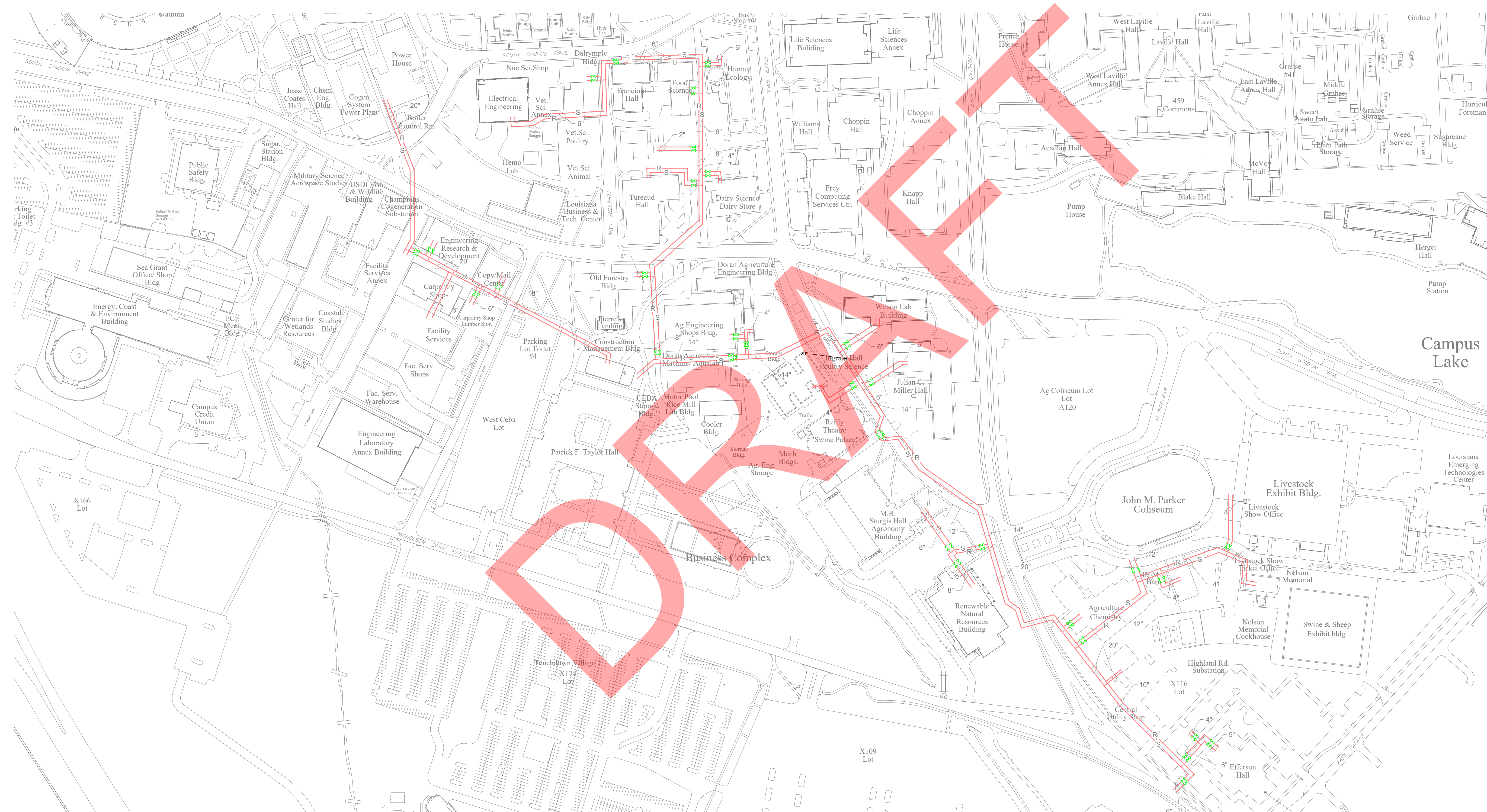

CAMPUS CHILLED WATER DISTRIBUTION - SOUTHEAST LOOP PLAN - MECHANICAL DEMOLITION
SCALE: 1"=160'

- EAST LOOP
- EAST QUAD LOOP
- NORTHWEST LOOP
- SOUTHEAST LOOP
- SOUTHWEST LOOP
- WEST QUAD LOOP
- - - - - DEMOLITION

SHEET FOR REFERENCE ONLY
NO DEMOLITION SCOPE IDENTIFIED

MARK	DATE	DESCRIPTION
ISSUE DATE:	09/17/21	
PROJECT NUMBER:	70-19-0025	
SHEET TITLE: CAMPUS CHILLED WATER DISTRIBUTION - SOUTHEAST LOOP PLAN - MECHANICAL DEMOLITION		
SHEET NUMBER: M211		

PRELIMINARY
FOR REVIEW ONLY

ENGINEER SEAL

**INITIAL MODERNIZATION SOLUTION
LOUISIANA STATE UNIVERSITY
LOUISIANA ENERGY PARTNERS**
BATON ROUGE, LOUISIANA

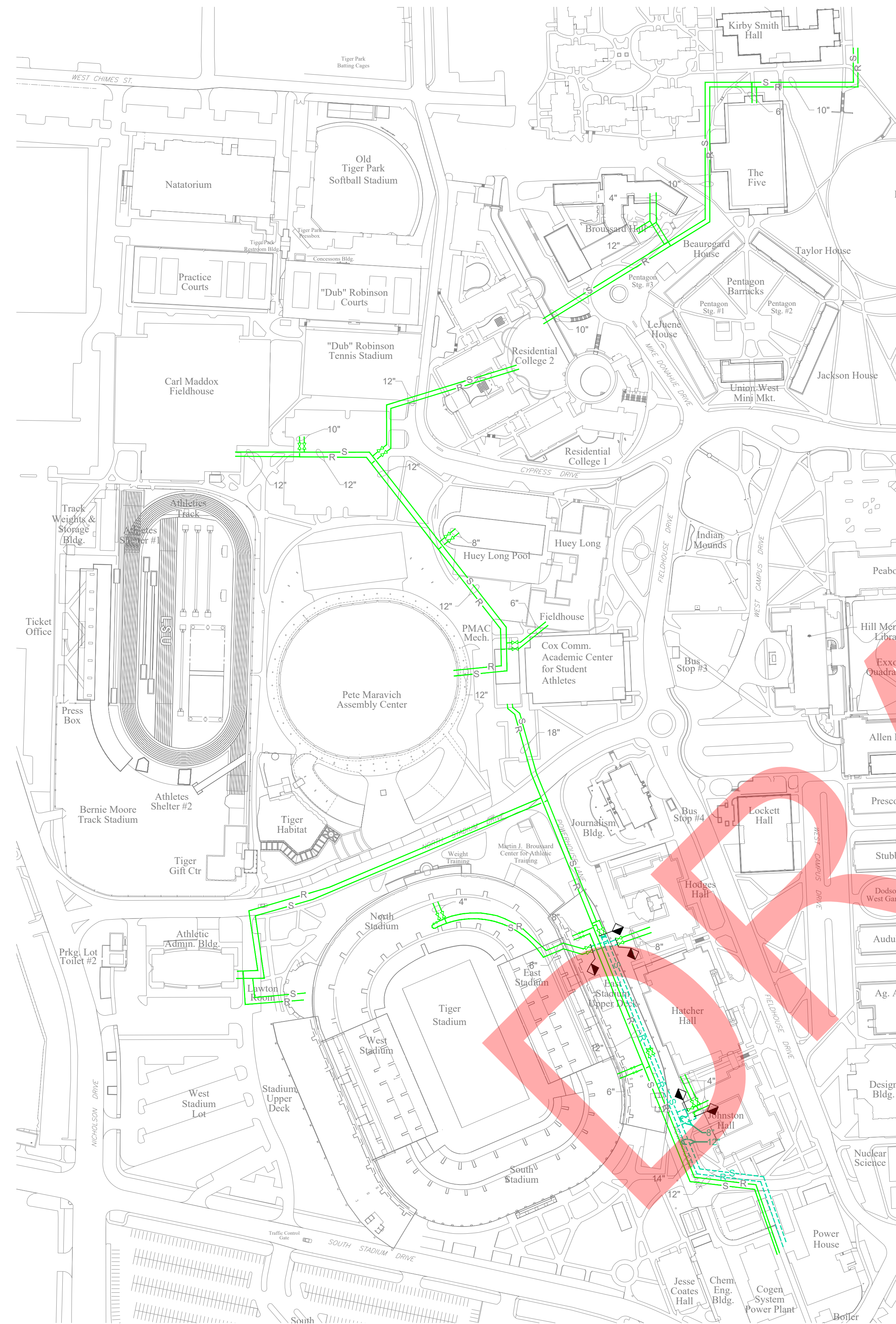

OPTION A

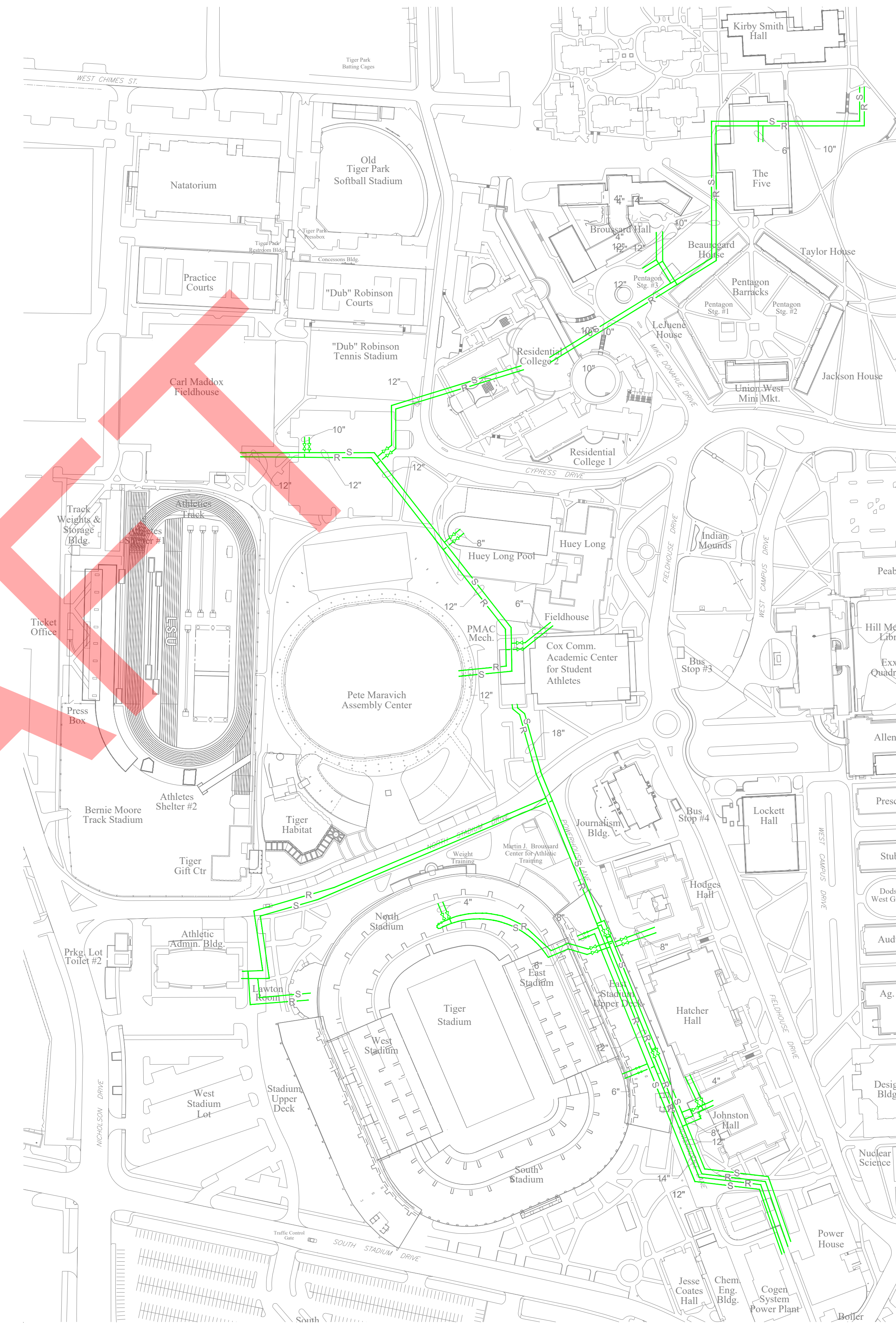

OPTION B DRAWING FOR REFERENCE ONLY
NO DEMOLITION SCOPE IDENTIFIED FOR OPTION B.

- EAST LOOP
- EAST QUAD LOOP
- NORTHWEST LOOP
- SOUTHEAST LOOP
- SOUTHWEST LOOP
- WEST QUAD LOOP
- - - DEMOLITION

1 CAMPUS CHILLED WATER DISTRIBUTION - NORTHWEST LOOP PLAN - MECHANICAL DEMOLITION

MARK	DATE	DESCRIPTION
ISSUE DATE:	09/17/21	
PROJECT NUMBER:	70-19-0025	
SHEET TITLE: CAMPUS CHILLED WATER DISTRIBUTION - NORTHWEST LOOP PLAN - MECHANICAL DEMOLITION		

SHEET NUMBER:
M212

PRELIMINARY
FOR REVIEW ONLY

ENGINEER SEAL

**INITIAL MODERNIZATION SOLUTION
LOUISIANA STATE UNIVERSITY
LOUISIANA ENERGY PARTNERS**
BATON ROUGE, LOUISIANA

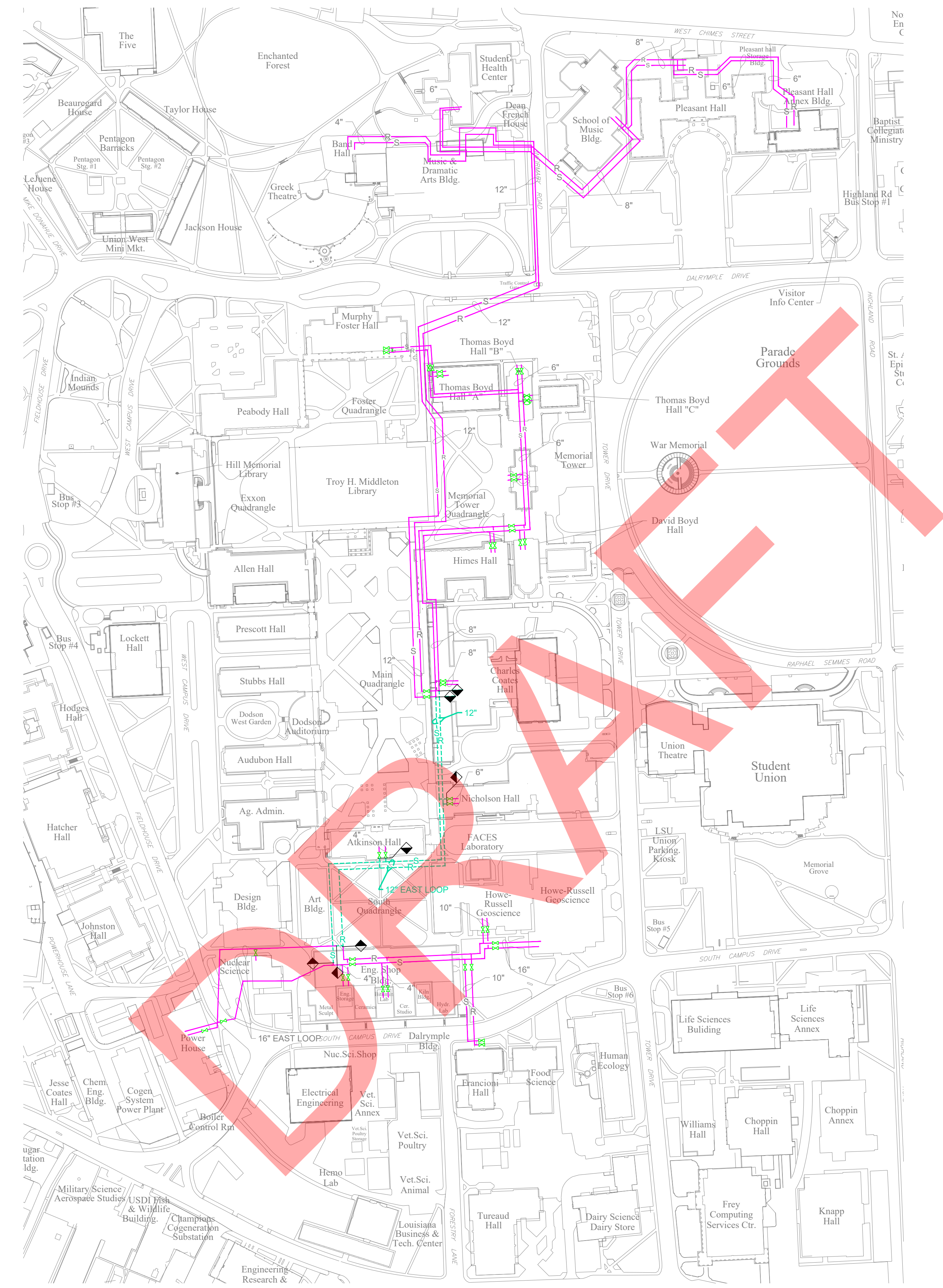





- EAST LOOP
- EAST QUAD LOOP
- NORTHWEST LOOP
- SOUTHEAST LOOP
- SOUTHWEST LOOP
- WEST QUAD LOOP
- - - - - DEMOLITION

1 CAMPUS CHILLED WATER DISTRIBUTION - EAST QUAD LOOP PLAN - MECHANICAL DEMOLITION

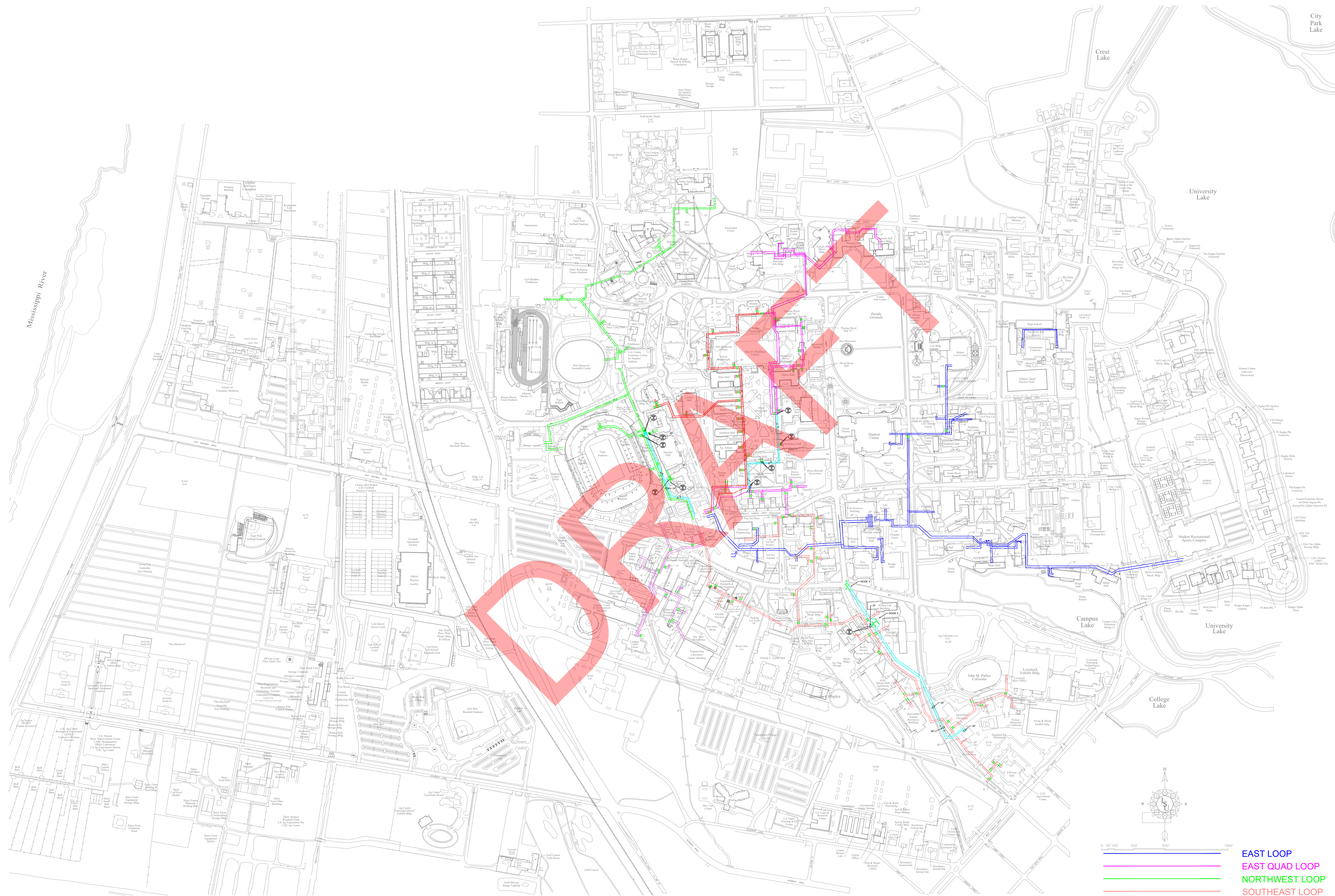
MARK	DATE	DESCRIPTION
ISSUE DATE:	09/17/21	
PROJECT NUMBER:	70-19-0025	
SHEET TITLE: CAMPUS CHILLED WATER DISTRIBUTION - EAST QUAD LOOP PLAN - MECHANICAL DEMOLITION		
SHEET NUMBER: M213		

**INITIAL MODERNIZATION SOLUTION
LOUISIANA STATE UNIVERSITY
LOUISIANA ENERGY PARTNERS**
BATON ROUGE, LOUISIANA



-  EAST LOOP
-  EAST QUAD LOOP
-  NORTHWEST LOOP
-  SOUTHWEST LOOP
-  WEST QUAD LOOP
-  NEW WORK

1 CAMPUS CHILLED WATER DISTRIBUTION - OVERALL CAMPUS PLAN - MECHANICAL
SCALE: 1"=300'-0"

MARK	DATE	DESCRIPTION

ISSUE DATE:	09/17/21
PROJECT NUMBER:	70-19-0025

SHEET TITLE:
CAMPUS CHILLED
WATER DISTRIBUTION -
OVERALL CAMPUS PLAN
- MECHANICAL

SHEET NUMBER:
M220

PRELIMINARY
FOR REVIEW ONLY

ENGINEER SEAL

**INITIAL MODERNIZATION SOLUTION
LOUISIANA STATE UNIVERSITY
LOUISIANA ENERGY PARTNERS**
BATON ROUGE, LOUISIANA

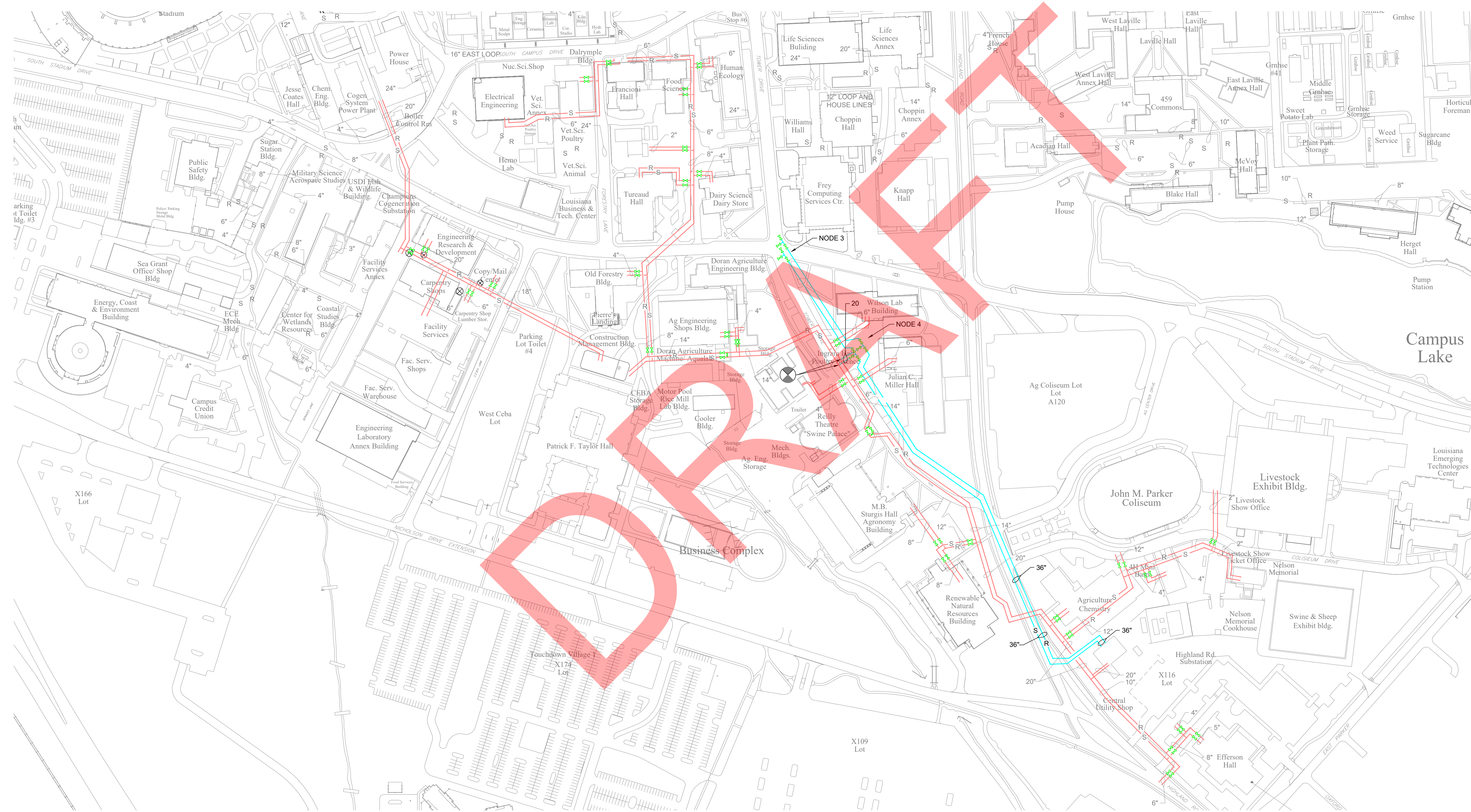

- EAST LOOP
- EAST QUAD LOOP
- NORTHWEST LOOP
- SOUTHEAST LOOP
- SOUTHWEST LOOP
- WEST QUAD LOOP
- NEW WORK

1 CAMPUS CHILLED WATER DISTRIBUTION - SOUTHEAST LOOP PLAN - MECHANICAL
SCALE: 1"=100'

MARK	DATE	DESCRIPTION
ISSUE DATE:	09/17/21	
PROJECT NUMBER:	70-19-0025	
SHEET TITLE: CAMPUS CHILLED WATER DISTRIBUTION - SOUTHEAST LOOP PLAN - MECHANICAL		
SHEET NUMBER: M221		

PRELIMINARY
FOR REVIEW ONLY

ENGINEER SEAL

**INITIAL MODERNIZATION SOLUTION
LOUISIANA STATE UNIVERSITY
LOUISIANA ENERGY PARTNERS**
BATON ROUGE, LOUISIANA

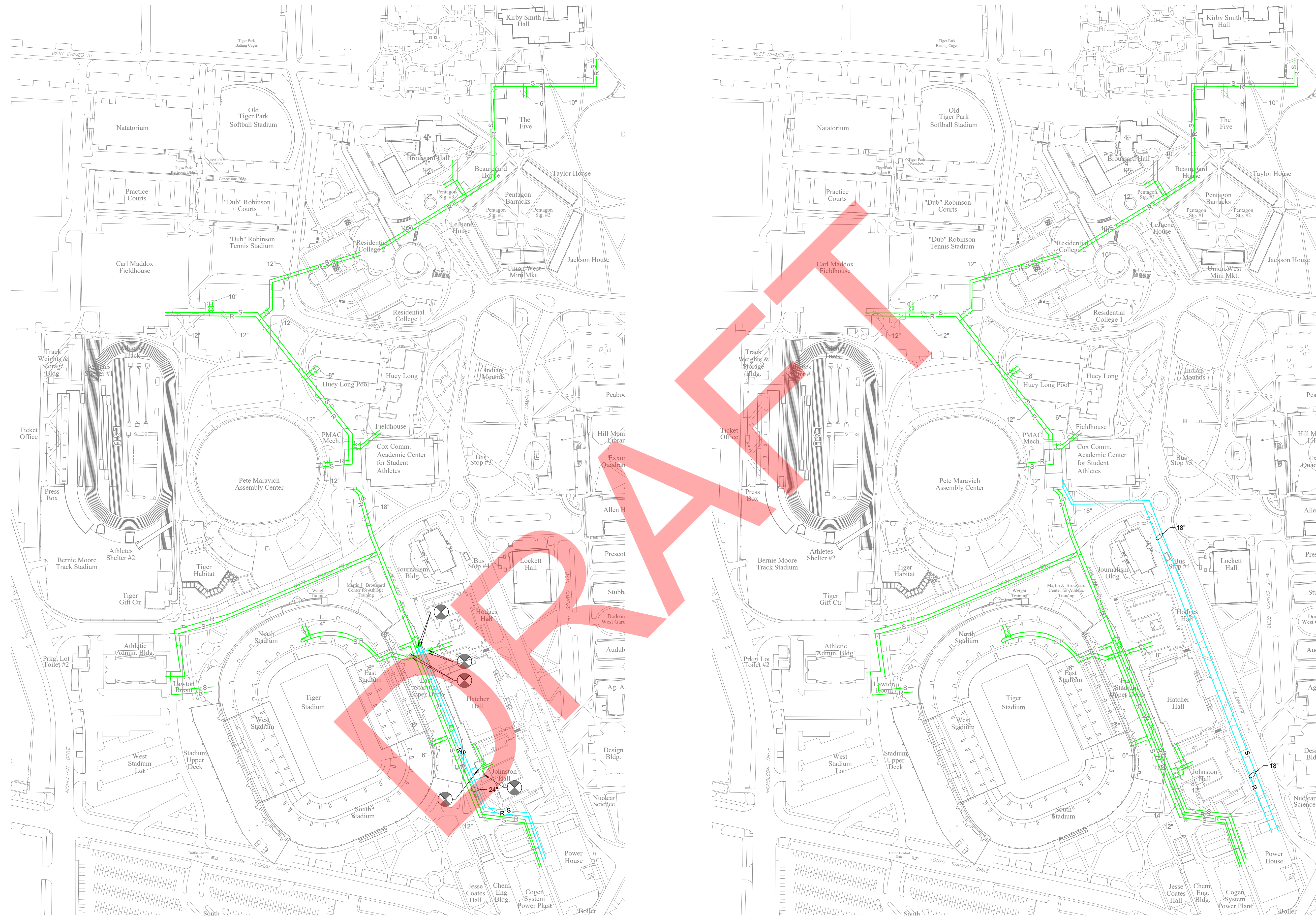

OPTION A

OPTION B WORK INDICATED FOR OPTION B IS DIRECT BORING OF PIPING IN APPROXIMATE ROUTE INDICATED.

- EAST LOOP
- EAST QUAD LOOP
- NORTHWEST LOOP
- SOUTHEAST LOOP
- SOUTHWEST LOOP
- WEST QUAD LOOP
- NEW WORK

1 CAMPUS CHILLED WATER DISTRIBUTION - NORTHWEST LOOP - MECHANICAL
SCALE: 1"=100'-0"

MARK	DATE	DESCRIPTION
ISSUE DATE:	09/17/21	
PROJECT NUMBER:	70-19-0025	
SHEET TITLE: CAMPUS CHILLED WATER DISTRIBUTION - NORTHWEST LOOP -MECHANICAL		
SHEET NUMBER: M222		

PRELIMINARY
FOR REVIEW ONLY

ENGINEER SEAL

**INITIAL MODERNIZATION SOLUTION
LOUISIANA STATE UNIVERSITY
LOUISIANA ENERGY PARTNERS**
BATON ROUGE, LOUISIANA

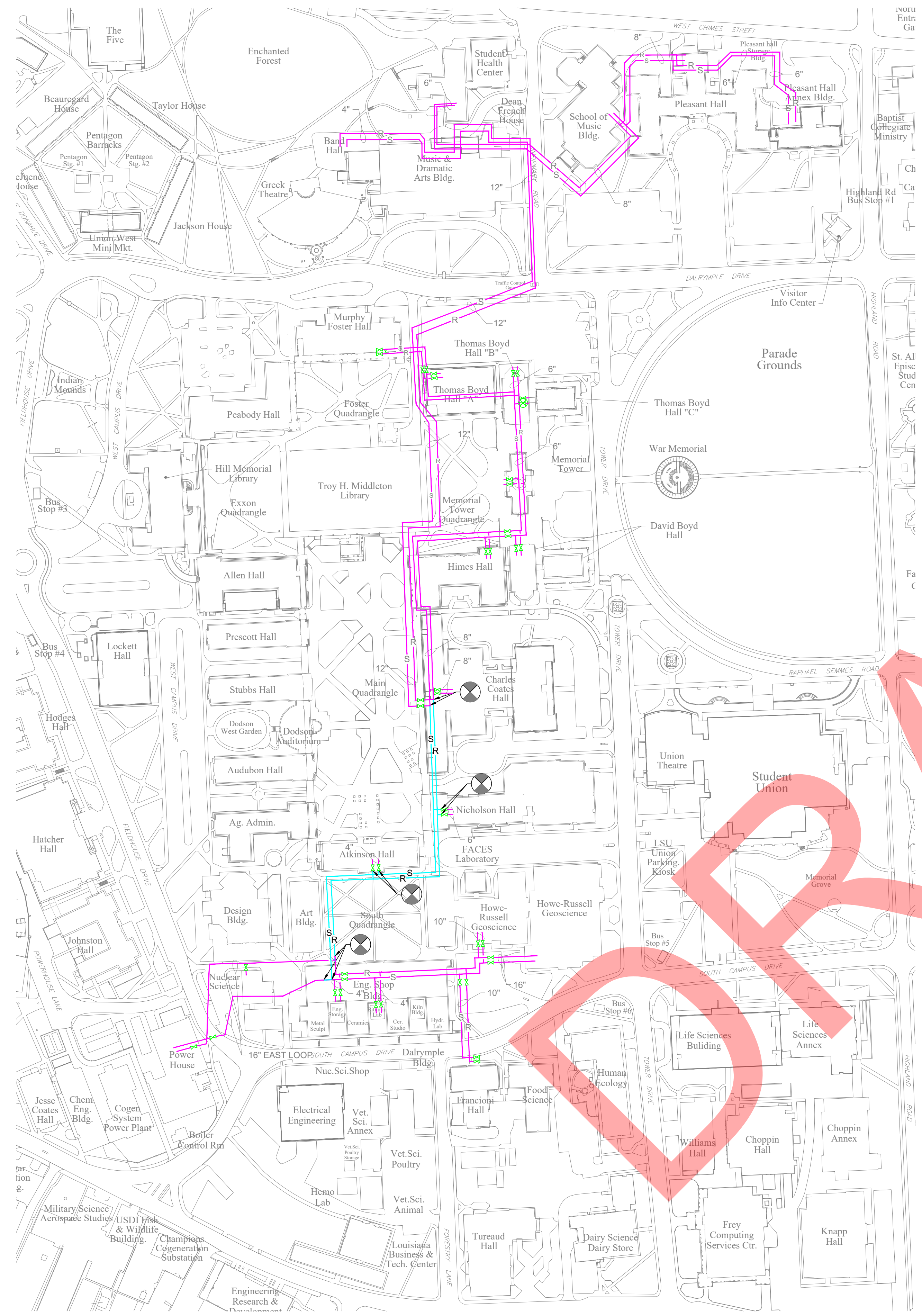

- EAST LOOP
- EAST QUAD LOOP
- NORTHWEST LOOP
- SOUTHEAST LOOP
- SOUTHWEST LOOP
- NEW WORK

1 CAMPUS CHILLED WATER DISTRIBUTION - EAST QUAD LOOP PLAN - MECHANICAL

MARK	DATE	DESCRIPTION
ISSUE DATE:	09/17/21	
PROJECT NUMBER:	70-19-0025	
SHEET TITLE: CAMPUS CHILLED WATER DISTRIBUTION - EAST QUAD LOOP PLAN - MECHANICAL		
SHEET NUMBER: M223		

GENERAL NOTES:

1. REMOVE AND DISPOSE OF IDENTIFIED EQUIPMENT, ASSOCIATED EQUIPMENT POWER AND CONTROLS TO BE REMOVED COMPLETELY. REFER TO ELECTRICAL.

**PRELIMINARY
FOR REVIEW ONLY**

ENGINEER SEAL

**INITIAL MODERNIZATION SOLUTION
LOUISIANA STATE UNIVERSITY
LOUISIANA ENERGY PARTNERS
BATON ROUGE, LOUISIANA**

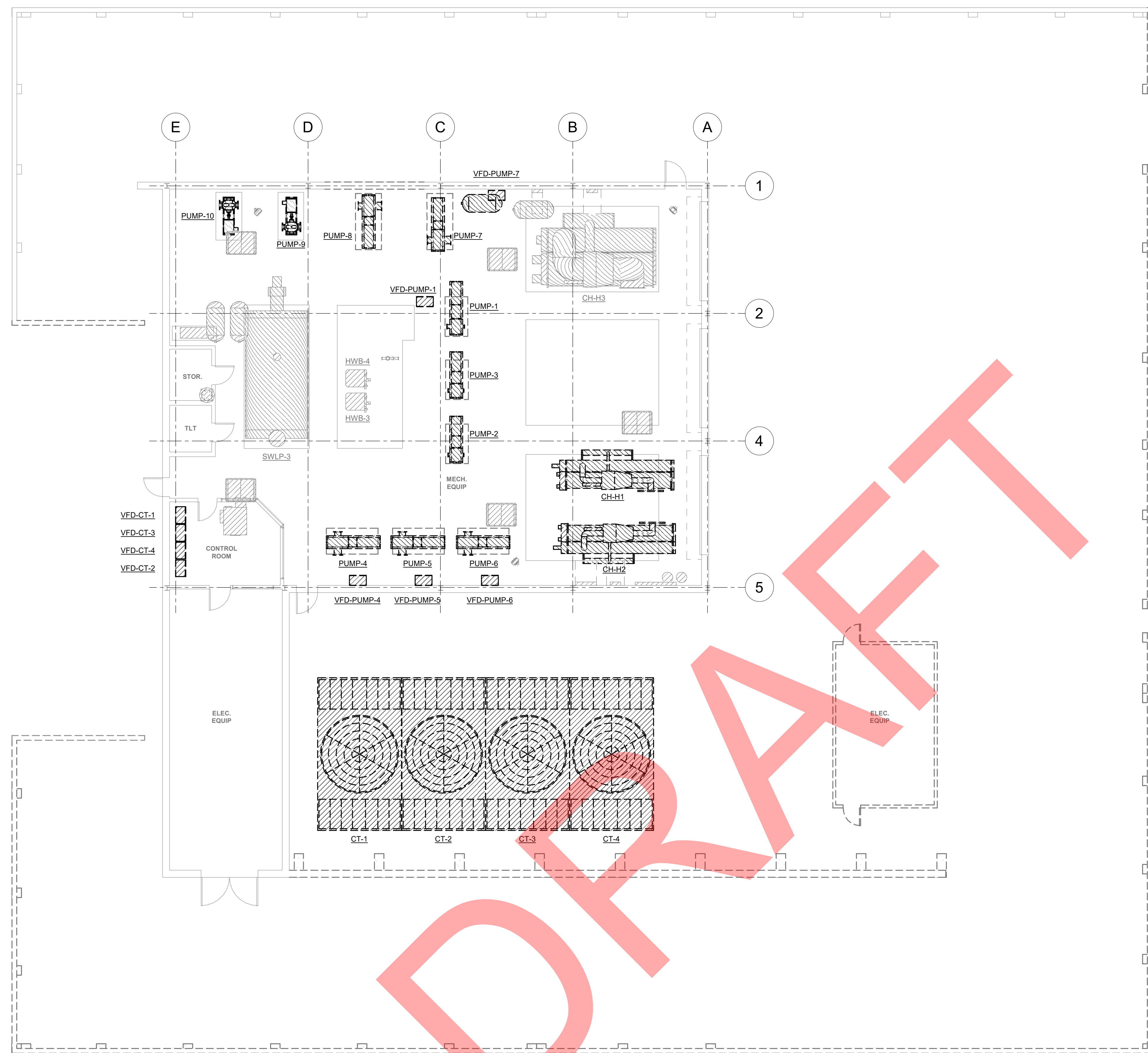

① HIGHLAND PLANT - FLOOR PLAN - MECHANICAL DEMOLITION

1/8" = 1'-0"

MARK	DATE	DESCRIPTION

ISSUE DATE:	09/17/21
PROJECT NUMBER:	70-19-0025
SHEET TITLE:	
HIGHLAND PLANT - FLOOR PLAN - MECHANICAL DEMOLITION	

SHEET NUMBER:
M310

**PRELIMINARY
FOR REVIEW ONLY**

ENGINEER SEAL

**INITIAL MODERNIZATION SOLUTION
LOUISIANA STATE UNIVERSITY
LOUISIANA ENERGY PARTNERS**
BATON ROUGE, LOUISIANA



1 HIGHLAND PLANT - FLOOR PLAN - MECHANICAL
1/8" = 1'-0"

MARK	DATE	DESCRIPTION
ISSUE DATE:	09/17/21	
PROJECT NUMBER:	70-19-0025	
SHEET TITLE:		
HIGHLAND PLANT - FLOOR PLAN - MECHANICAL		
SHEET NUMBER:		
M320		

PRELIMINARY
FOR REVIEW ONLY

ENGINEER SEAL

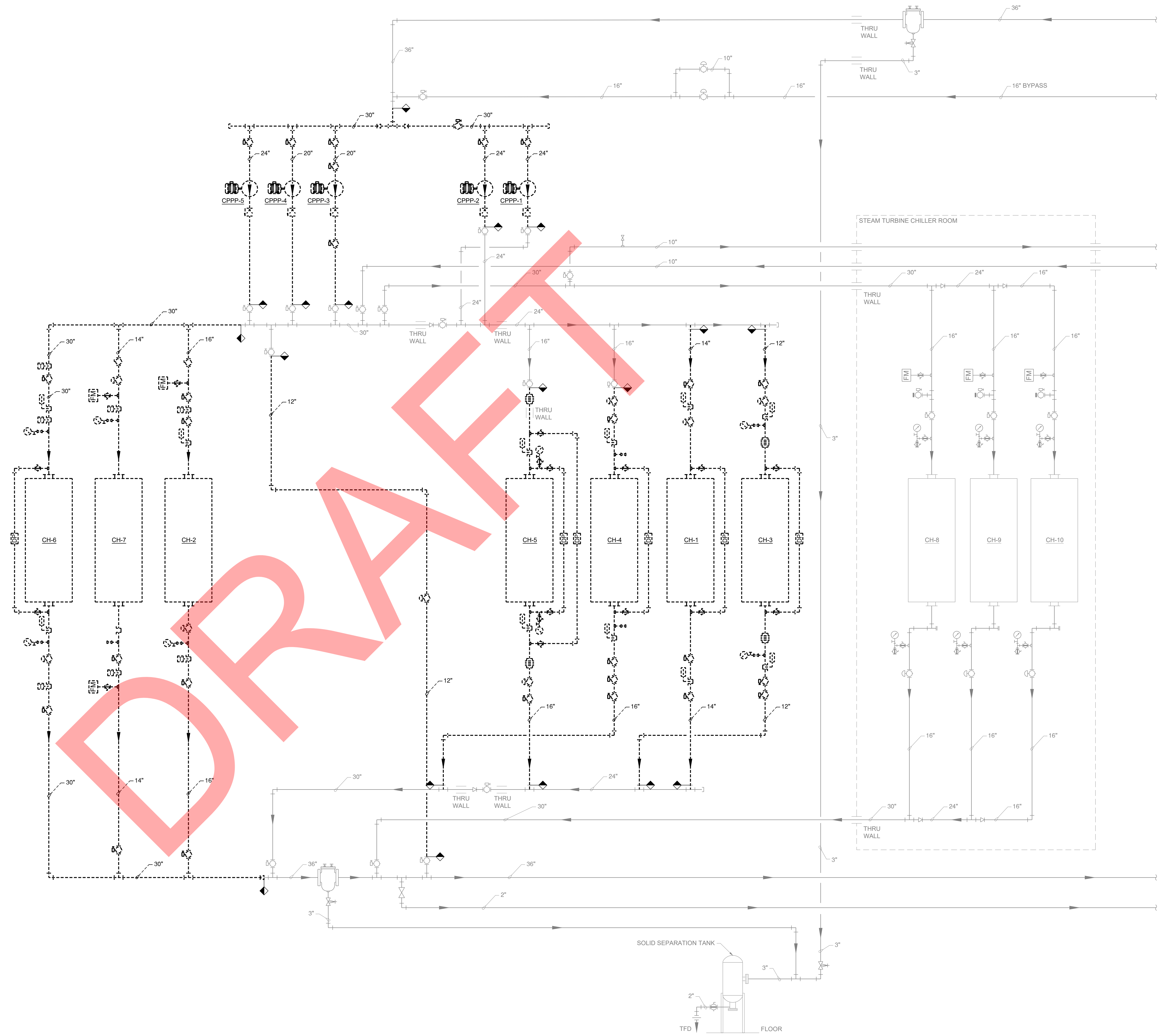

**INITIAL MODERNIZATION SOLUTION
LOUISIANA STATE UNIVERSITY
LOUISIANA ENERGY PARTNERS
BATON ROUGE, LOUISIANA**

MARK	DATE	DESCRIPTION

ISSUE DATE:	09/17/21
PROJECT NUMBER:	70-19-0025

SHEET TITLE:
MAIN PLANT PRODUCTION -
PIPING DIAGRAMS - CHILLED
WATER - MECHANICAL
DEMOLITION

SHEET NUMBER:
M400

1 MAIN PLANT PRODUCTION - PIPING DIAGRAMS - CHILLED WATER - MECHANICAL DEMOLITION

PRELIMINARY
FOR REVIEW ONLY

ENGINEER SEAL

INITIAL MODERNIZATION SOLUTION
LOUISIANA STATE UNIVERSITY
LOUISIANA ENERGY PARTNERS
BATON ROUGE, LOUISIANA

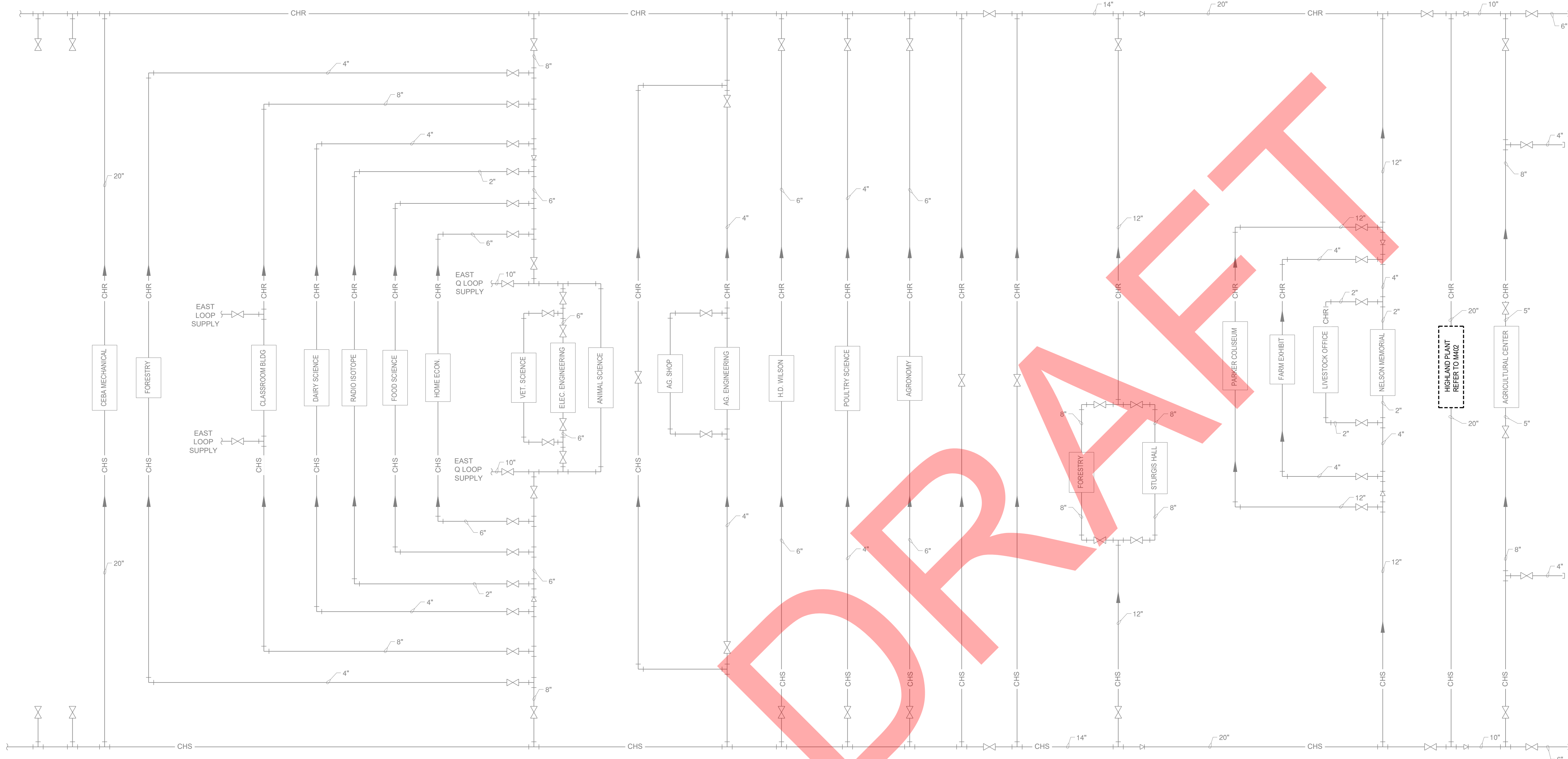

① SOUTHEAST LOOP DISTRIBUTION- PIPING DIAGRAMS - CHILLED WATER - MECHANICAL DEMOLITION

MARK	DATE	DESCRIPTION

ISSUE DATE:	09/17/21
PROJECT NUMBER:	70-19-0025

SHEET TITLE:
SOUTHEAST LOOP
DISTRIBUTION - PIPING
DIAGRAMS - CHILLED WATER -
MECHANICAL DEMOLITION

SHEET NUMBER:
M403

PRELIMINARY
FOR REVIEW ONLY

ENGINEER SEAL

**INITIAL MODERNIZATION SOLUTION
LOUISIANA STATE UNIVERSITY
LOUISIANA ENERGY PARTNERS
BATON ROUGE, LOUISIANA**

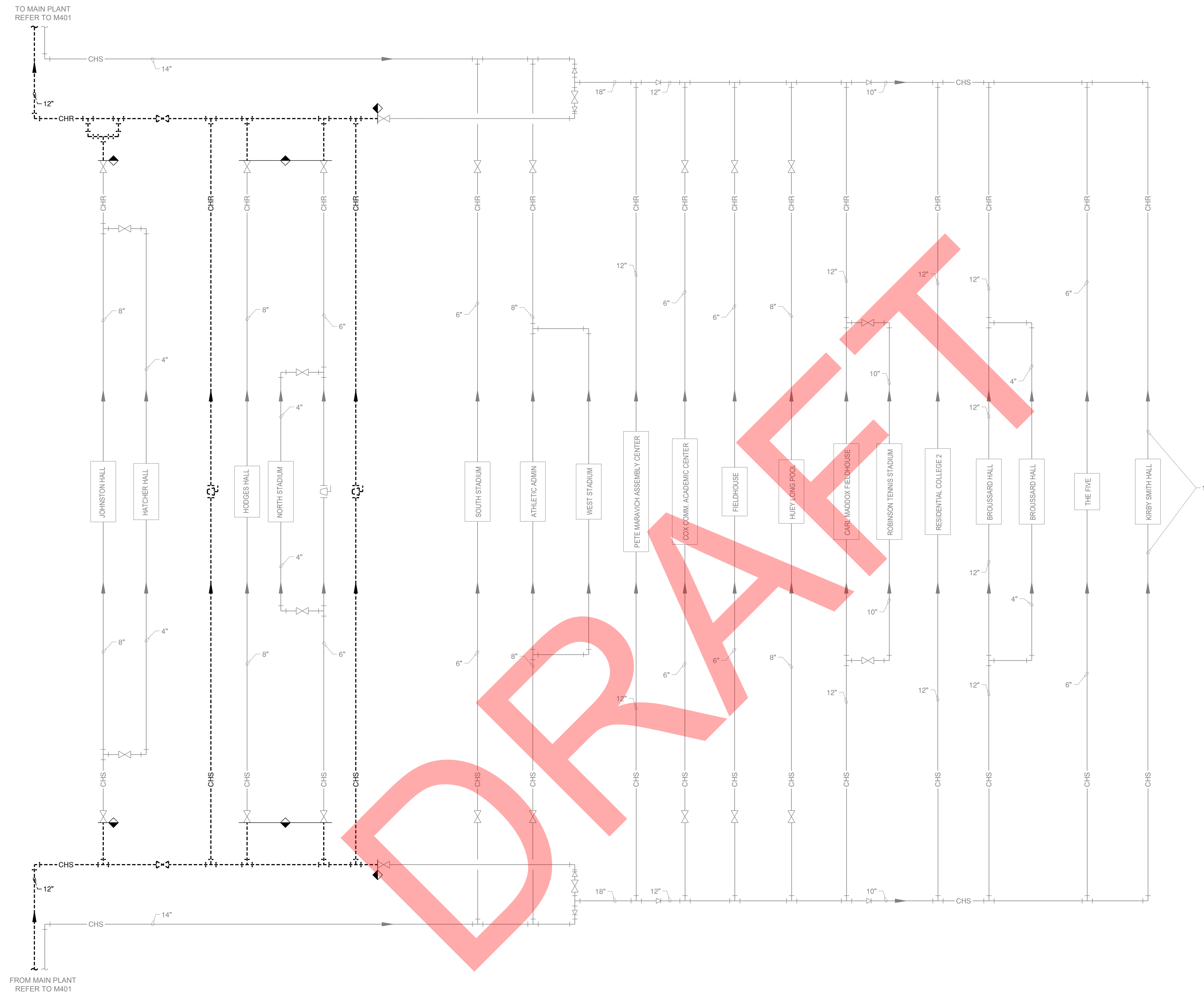

1 NORTHWEST LOOP DISTRIBUTION - PIPING DIAGRAMS - CHILLED WATER - MECHANICAL DEMOLITION - OPTION A

NOTE:
SHEET FOR REFERENCE ONLY, NO DEMOLITION
SCOPE IDENTIFIED FOR THIS OPTION

MARK	DATE	DESCRIPTION

ISSUE DATE:	09/17/21
PROJECT NUMBER:	70-19-0025
SHEET TITLE:	
NORTHWEST LOOP DISTRIBUTION - PIPING DIAGRAMS - CHILLED WATER - MECHANICAL DEMOLITION - OPTION A	
SHEET NUMBER:	
M404A	

PRELIMINARY
FOR REVIEW ONLY

ENGINEER SEAL

**INITIAL MODERNIZATION SOLUTION
LOUISIANA STATE UNIVERSITY
LOUISIANA ENERGY PARTNERS
BATON ROUGE, LOUISIANA**

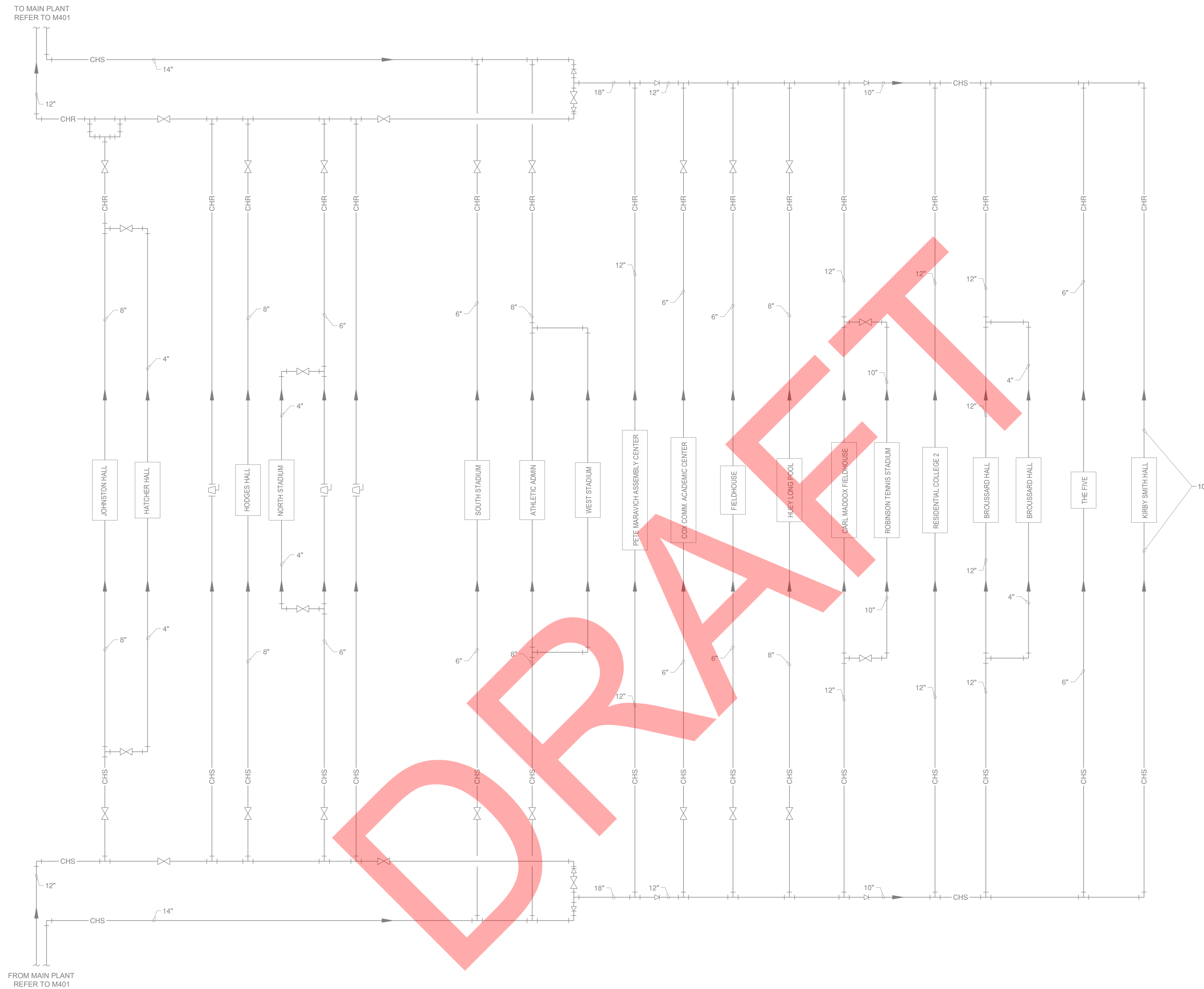

① NORTHWEST LOOP DISTRIBUTION - PIPING DIAGRAMS - CHILLED WATER - MECHANICAL DEMOLITION - OPTION B

SHEET FOR REFERENCE ONLY
NO DEMOLITION SCOPE IDENTIFIED FOR OPTION B.

MARK	DATE	DESCRIPTION

ISSUE DATE:	09/17/21
PROJECT NUMBER:	70-19-0025

SHEET TITLE:
NORTHWEST LOOP
DISTRIBUTION - PIPING DIAGRAM
- CHILLED WATER - MECHANICAL
DEMOLITION - OPTION B

SHEET NUMBER:
M404B

PRELIMINARY
FOR REVIEW ONLY

ENGINEER SEAL

INITIAL MODERNIZATION SOLUTION
LOUISIANA STATE UNIVERSITY
LOUISIANA ENERGY PARTNERS
BATON ROUGE, LOUISIANA

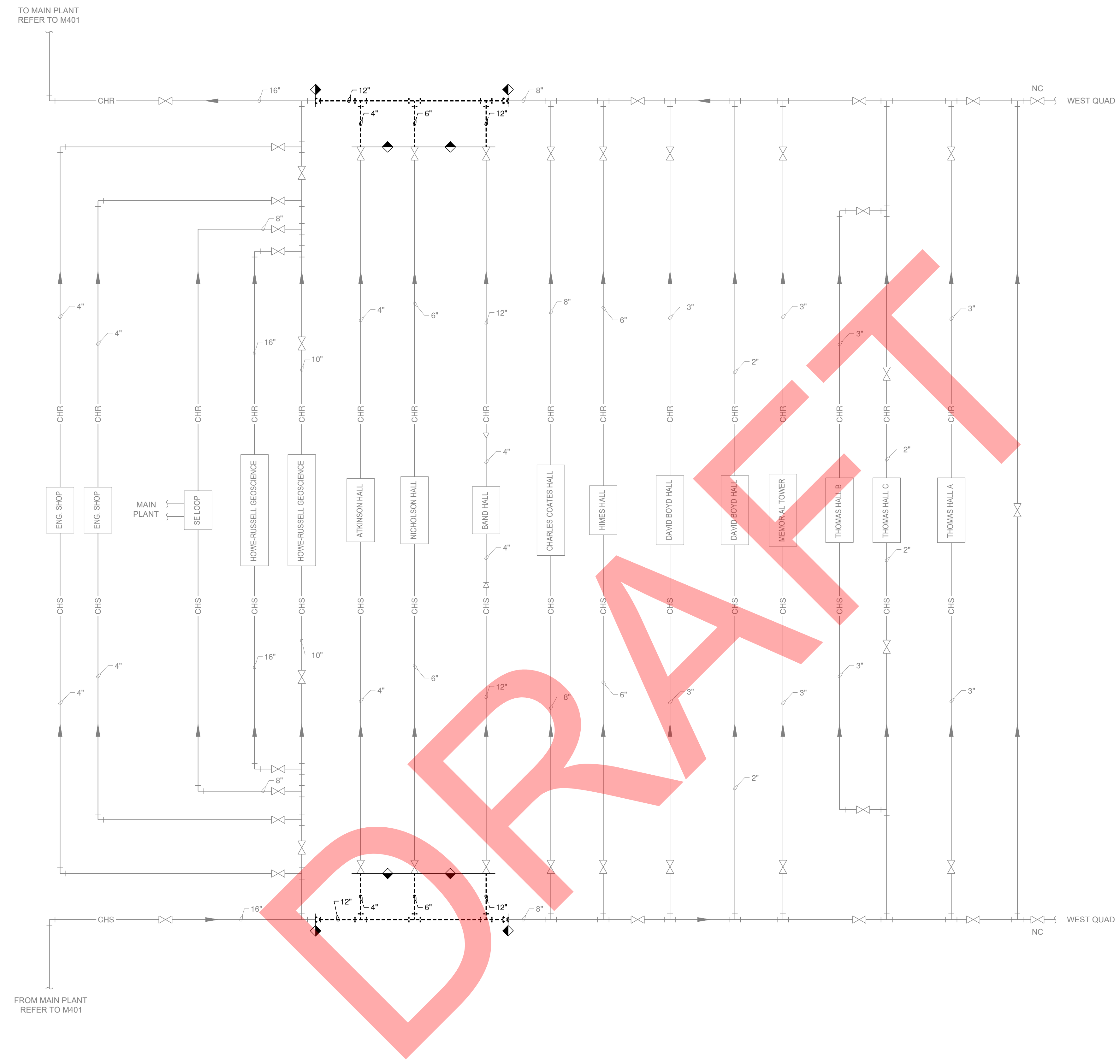

① EAST QUAD LOOP DISTRIBUTION - PIPING DIAGRAMS - CHILLED WATER - MECHANICAL DEMOLITION

MARK	DATE	DESCRIPTION

ISSUE DATE:	09/17/21
PROJECT NUMBER:	70-19-0025

SHEET TITLE:
EAST QUAD LOOP DISTRIBUTION
- PIPING DIAGRAMS - CHILLED
WATER - MECHANICAL
DEMOLITION

SHEET NUMBER:
M405

PRELIMINARY
FOR REVIEW ONLY

ENGINEER SEAL

**INITIAL MODERNIZATION SOLUTION
LOUISIANA STATE UNIVERSITY
LOUISIANA ENERGY PARTNERS
BATON ROUGE, LOUISIANA**

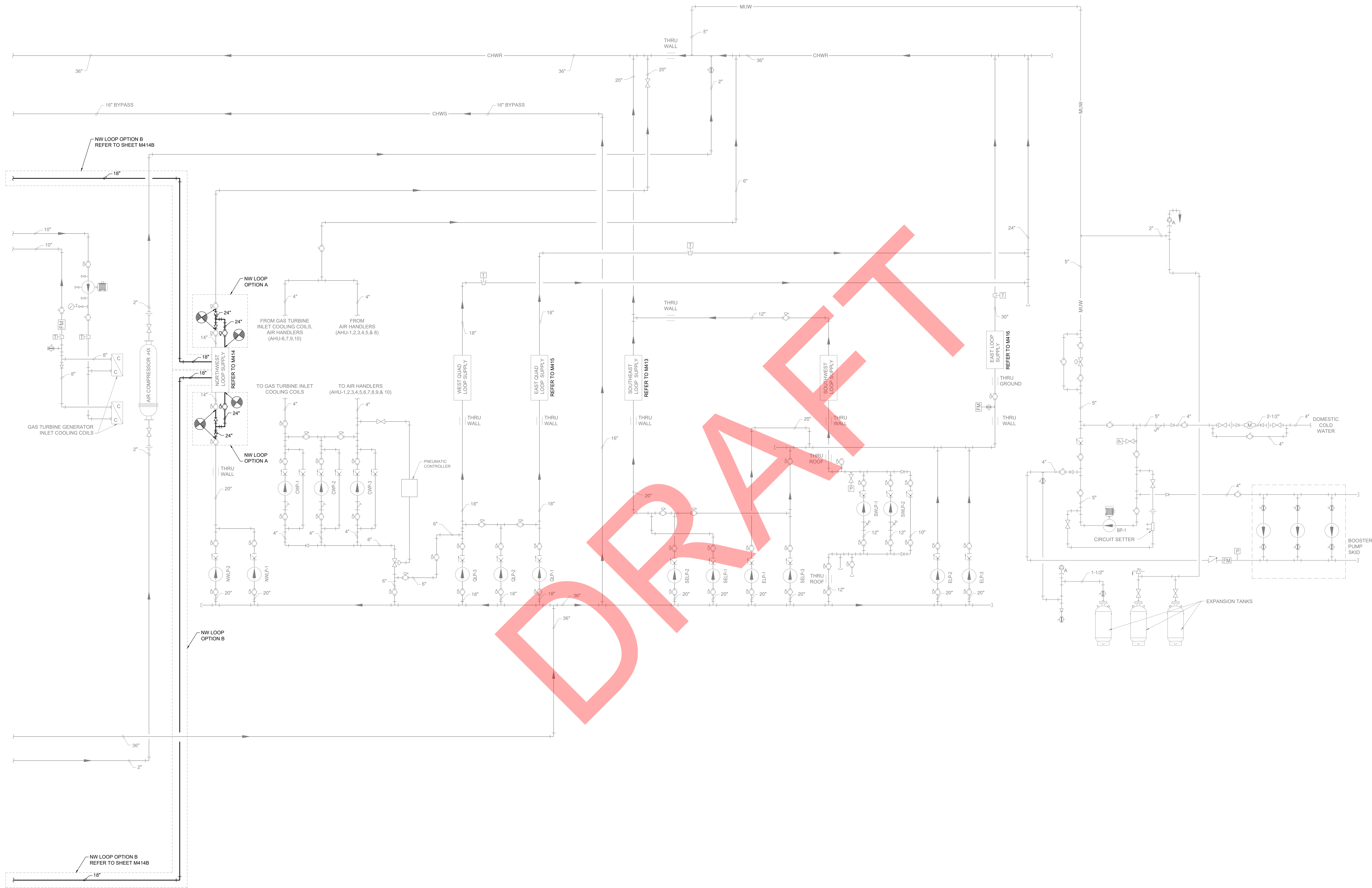

① CAMPUS DISTRIBUTION - PIPING DIAGRAMS - CHILLED WATER - MECHANICAL

MARK	DATE	DESCRIPTION
ISSUE DATE:	09/17/21	
PROJECT NUMBER:	70-19-0025	
SHEET TITLE: CAMPUS DISTRIBUTION - PIPING DIAGRAMS - CHILLED WATER - MECHANICAL		
SHEET NUMBER: M411		

PRELIMINARY
FOR REVIEW ONLY

ENGINEER SEAL

**INITIAL MODERNIZATION SOLUTION
LOUISIANA STATE UNIVERSITY
LOUISIANA ENERGY PARTNERS**
BATON ROUGE, LOUISIANA

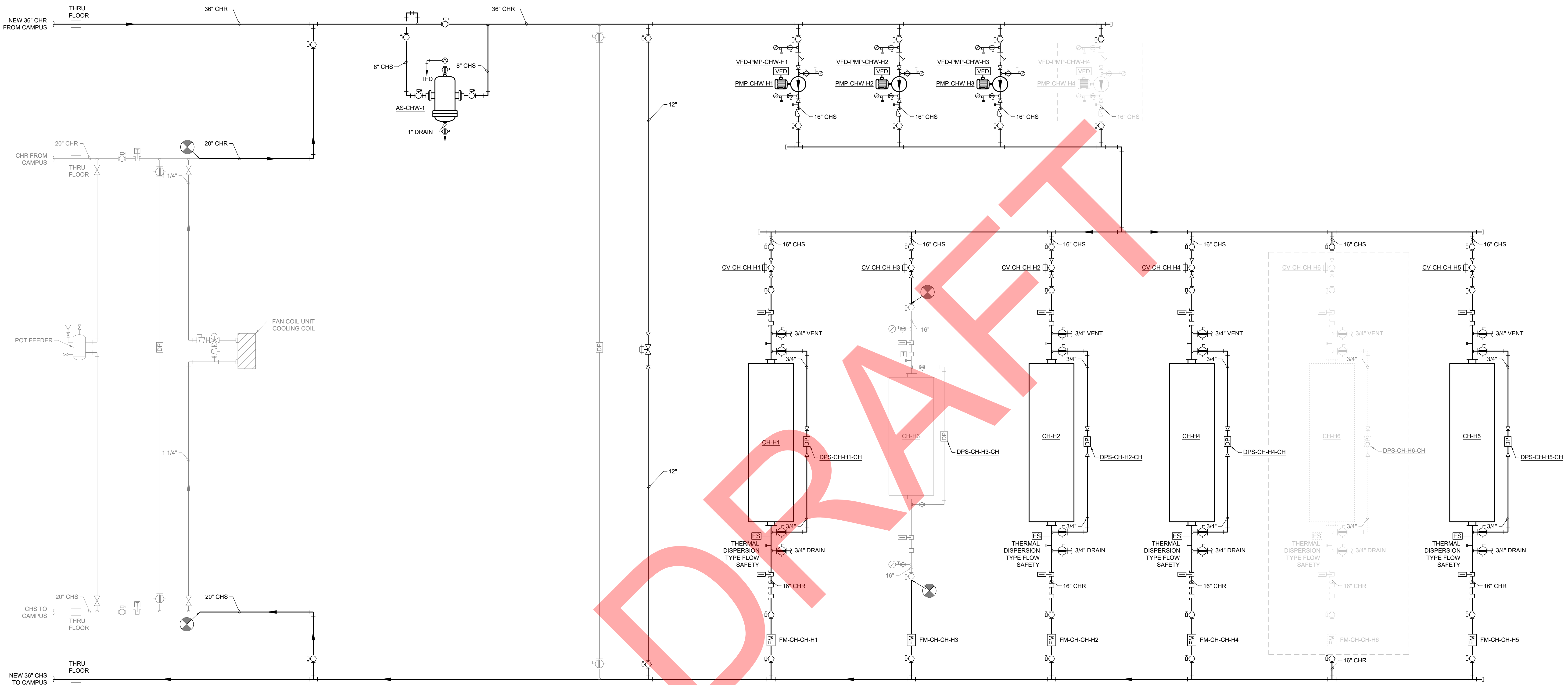

① HIGHLAND PLANT PRODUCTION - PIPING DIAGRAMS - CHILLED WATER - MECHANICAL

MARK	DATE	DESCRIPTION

ISSUE DATE:	09/17/21
PROJECT NUMBER:	70-19-0025
SHEET TITLE:	
HIGHLAND PLANT PRODUCTION - PIPING DIAGRAMS - CHILLED WATER - MECHANICAL	

SHEET NUMBER:
M412

PRELIMINARY
FOR REVIEW ONLY

ENGINEER SEAL

**INITIAL MODERNIZATION SOLUTION
LOUISIANA STATE UNIVERSITY
LOUISIANA ENERGY PARTNERS**
BATON ROUGE, LOUISIANA

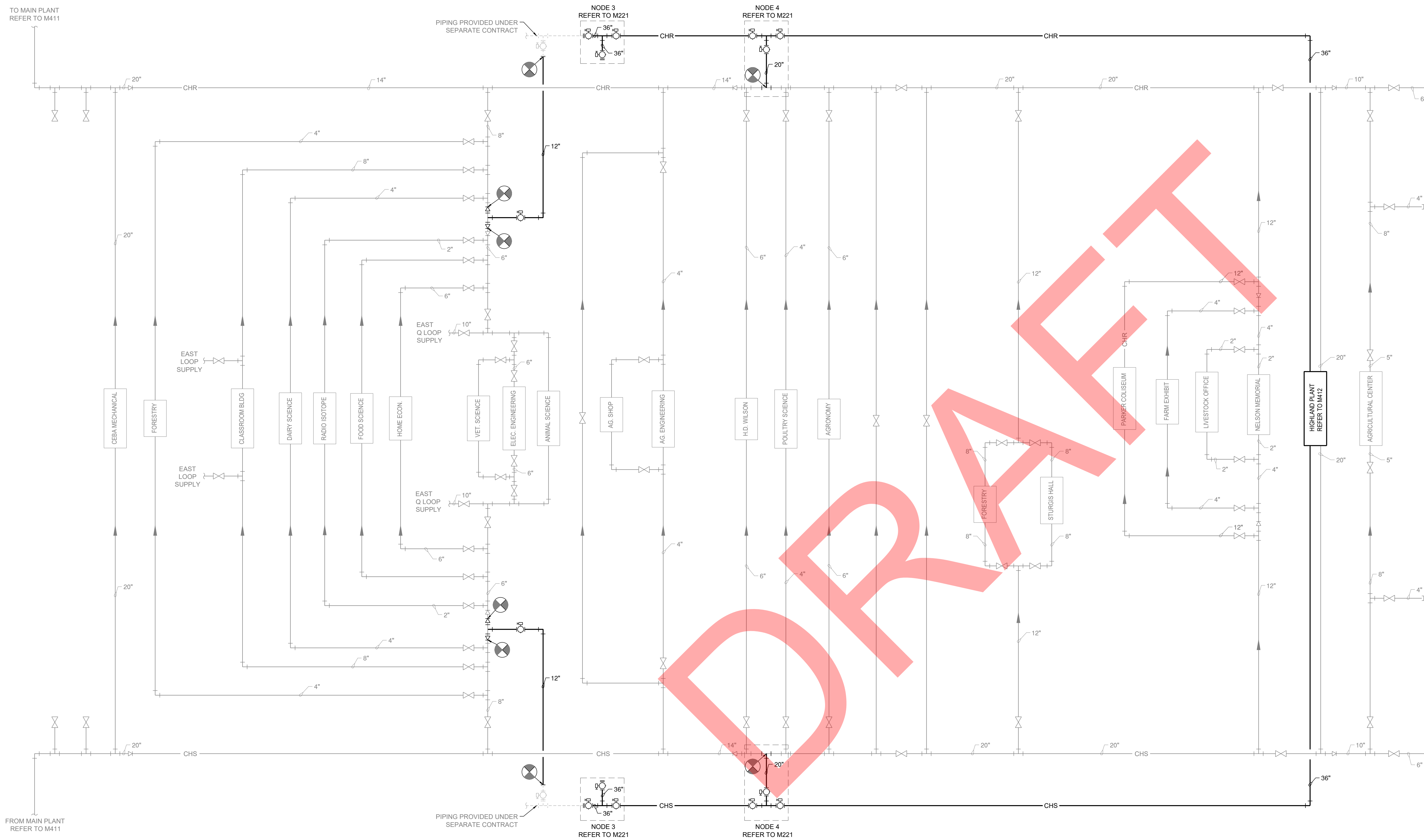

MARK	DATE	DESCRIPTION

ISSUE DATE:	09/17/21
PROJECT NUMBER:	70-19-0025
SHEET TITLE: SOUTHEAST LOOP DISTRIBUTION- PIPING DIAGRAMS - CHILLED WATER - MECHANICAL	

SHEET NUMBER:
M413

1 SOUTHEAST LOOP DISTRIBUTION - PIPING DIAGRAMS - CHILLED WATER - MECHANICAL

**PRELIMINARY
FOR REVIEW ONLY**

ENGINEER SEAL

**INITIAL MODERNIZATION SOLUTION
LOUISIANA STATE UNIVERSITY
LOUISIANA ENERGY PARTNERS
BATON ROUGE, LOUISIANA**

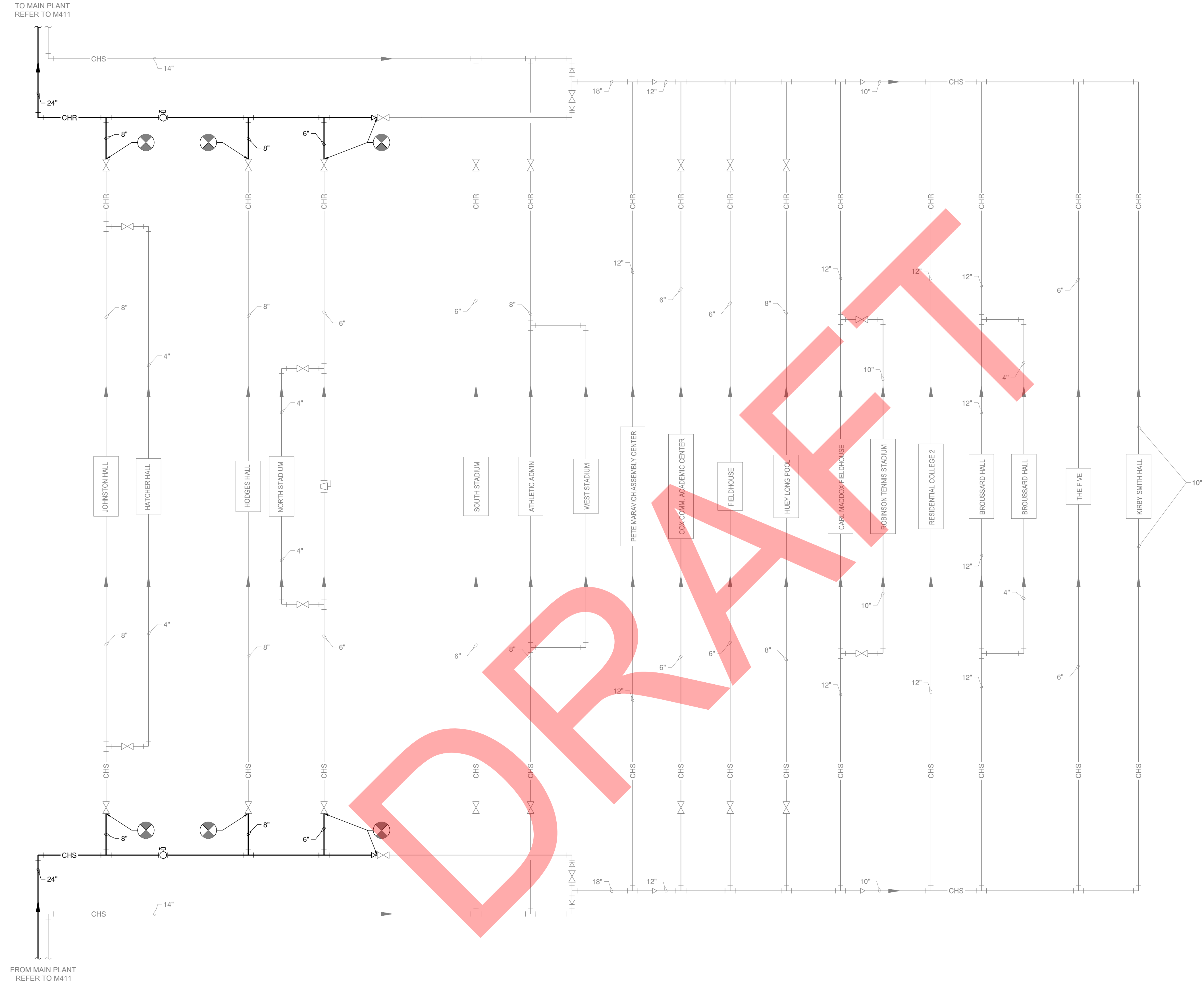

① NORTHWEST LOOP DISTRIBUTION - PIPING DIAGRAMS - CHILLED WATER - MECHANICAL - OPTION A

MARK	DATE	DESCRIPTION

ISSUE DATE:	09/17/21
PROJECT NUMBER:	70-19-0025

SHEET TITLE:
NORTHWEST LOOP OPTION A -
PIPING DIAGRAMS - CHILLED
WATER - MECHANICAL

SHEET NUMBER:
M414A

PRELIMINARY
FOR REVIEW ONLY

ENGINEER SEAL

**INITIAL MODERNIZATION SOLUTION
LOUISIANA STATE UNIVERSITY
LOUISIANA ENERGY PARTNERS
BATON ROUGE, LOUISIANA**

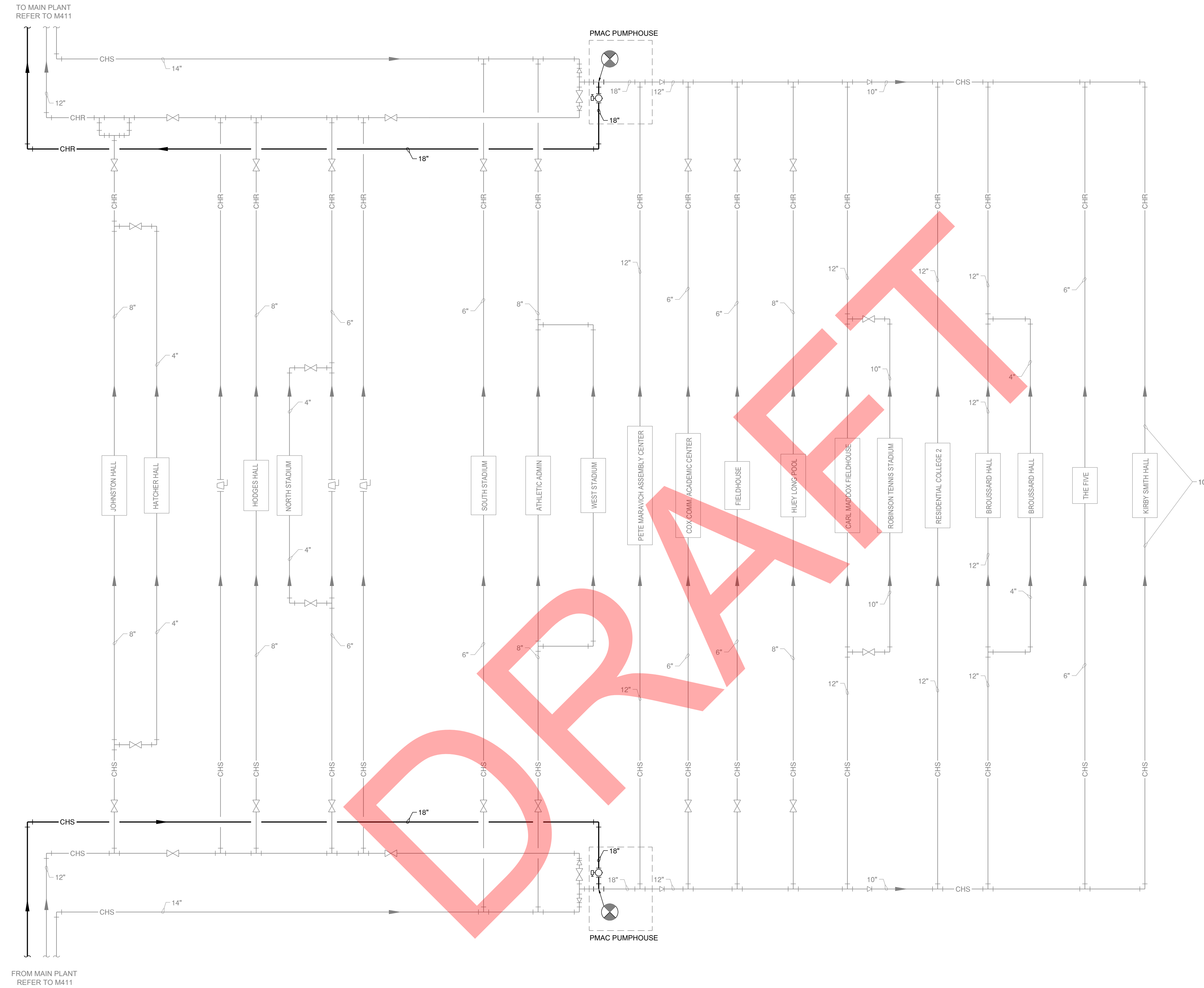

① NORTHWEST LOOP DISTRIBUTION - PIPING DIAGRAMS - CHILLED WATER - MECHANICAL - OPTION B

MARK	DATE	DESCRIPTION

ISSUE DATE:	09/17/21
PROJECT NUMBER:	70-19-0025

SHEET TITLE:
NORTHWEST LOOP OPTION 2 -
PIPING DIAGRAMS - CHILLED
WATER - MECHANICAL

SHEET NUMBER:
M414B

PRELIMINARY
FOR REVIEW ONLY

ENGINEER SEAL

INITIAL MODERNIZATION SOLUTION
LOUISIANA STATE UNIVERSITY
LOUISIANA ENERGY PARTNERS
BATON ROUGE, LOUISIANA

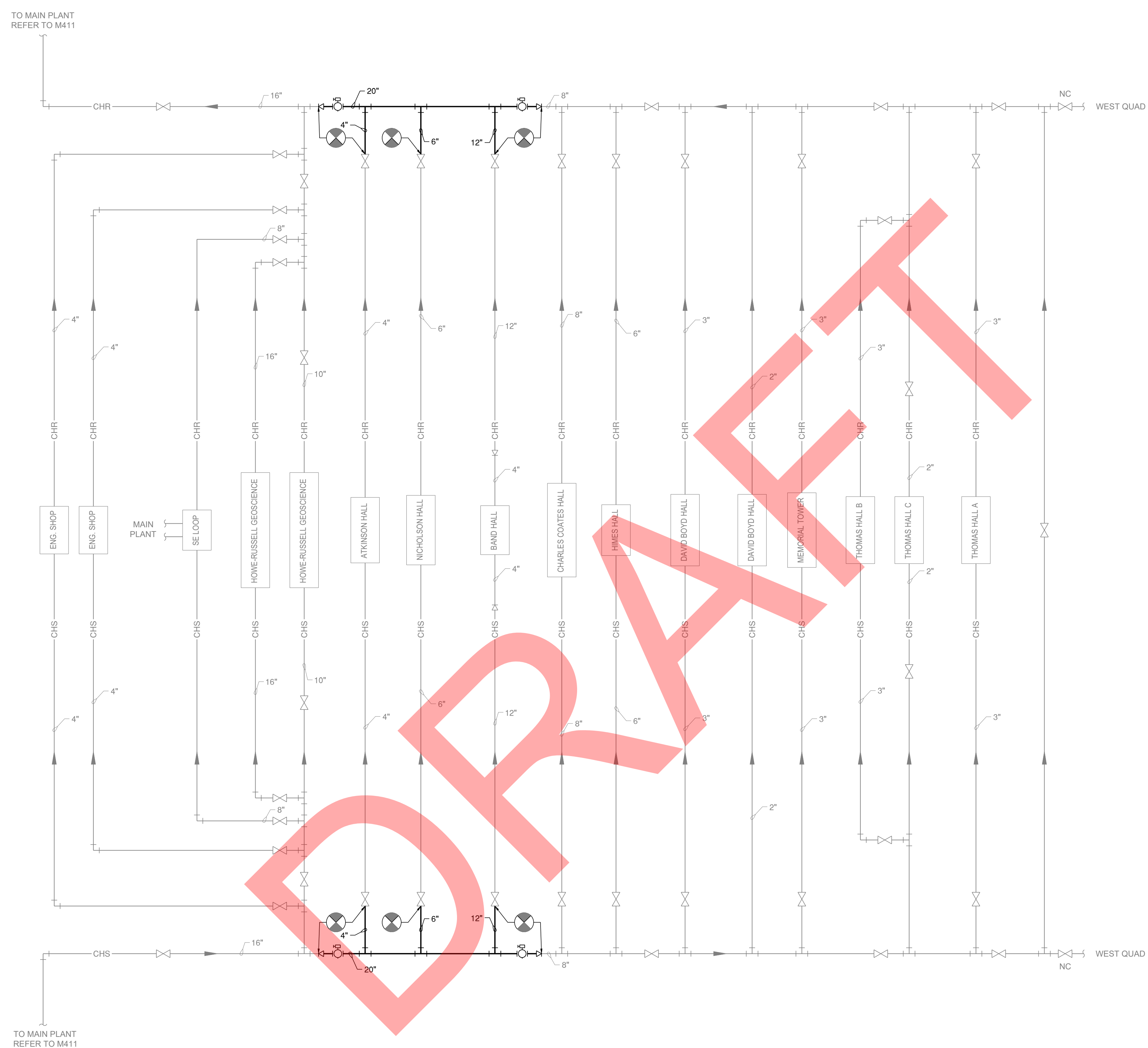

1 EAST QUAD LOOP DISTRIBUTION - PIPING DIAGRAMS - CHILLED WATER - MECHANICAL

MARK	DATE	DESCRIPTION

ISSUE DATE:	09/17/21
PROJECT NUMBER:	70-19-0025

SHEET TITLE:	EAST QUAD LOOP - PIPING DIAGRAMS - CHILLED WATER - MECHANICAL
SHEET NUMBER:	M415

PRELIMINARY
FOR REVIEW ONLY

ENGINEER SEAL

INITIAL MODERNIZATION SOLUTION
LOUISIANA STATE UNIVERSITY
LOUISIANA ENERGY PARTNERS
BATON ROUGE, LOUISIANA

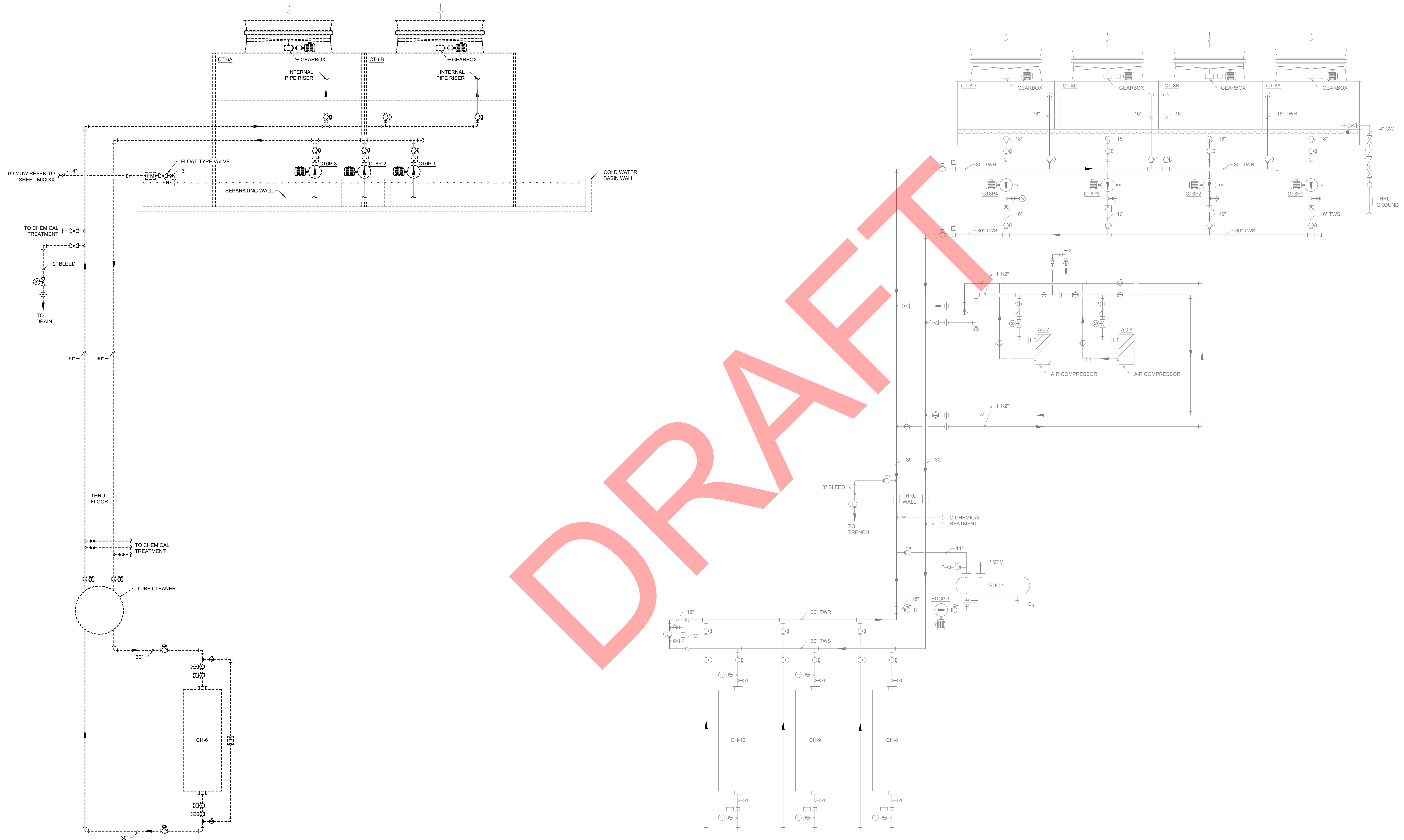

① MAIN PLANT - PIPING DIAGRAMS - TOWER WATER CONT. - MECHANICAL DEMOLITION
NOT TO SCALE

MARK	DATE	DESCRIPTION
ISSUE DATE:	09/17/21	
PROJECT NUMBER:	70-19-0025	
SHEET TITLE:		
MAIN PLANT - PIPING DIAGRAMS - TOWER WATER CONT. - MECHANICAL DEMOLITION		

SHEET NUMBER:
M421

PRELIMINARY
FOR REVIEW ONLY

ENGINEER SEAL

INITIAL MODERNIZATION SOLUTION
LOUISIANA STATE UNIVERSITY
LOUISIANA ENERGY PARTNERS
BATON ROUGE, LOUISIANA

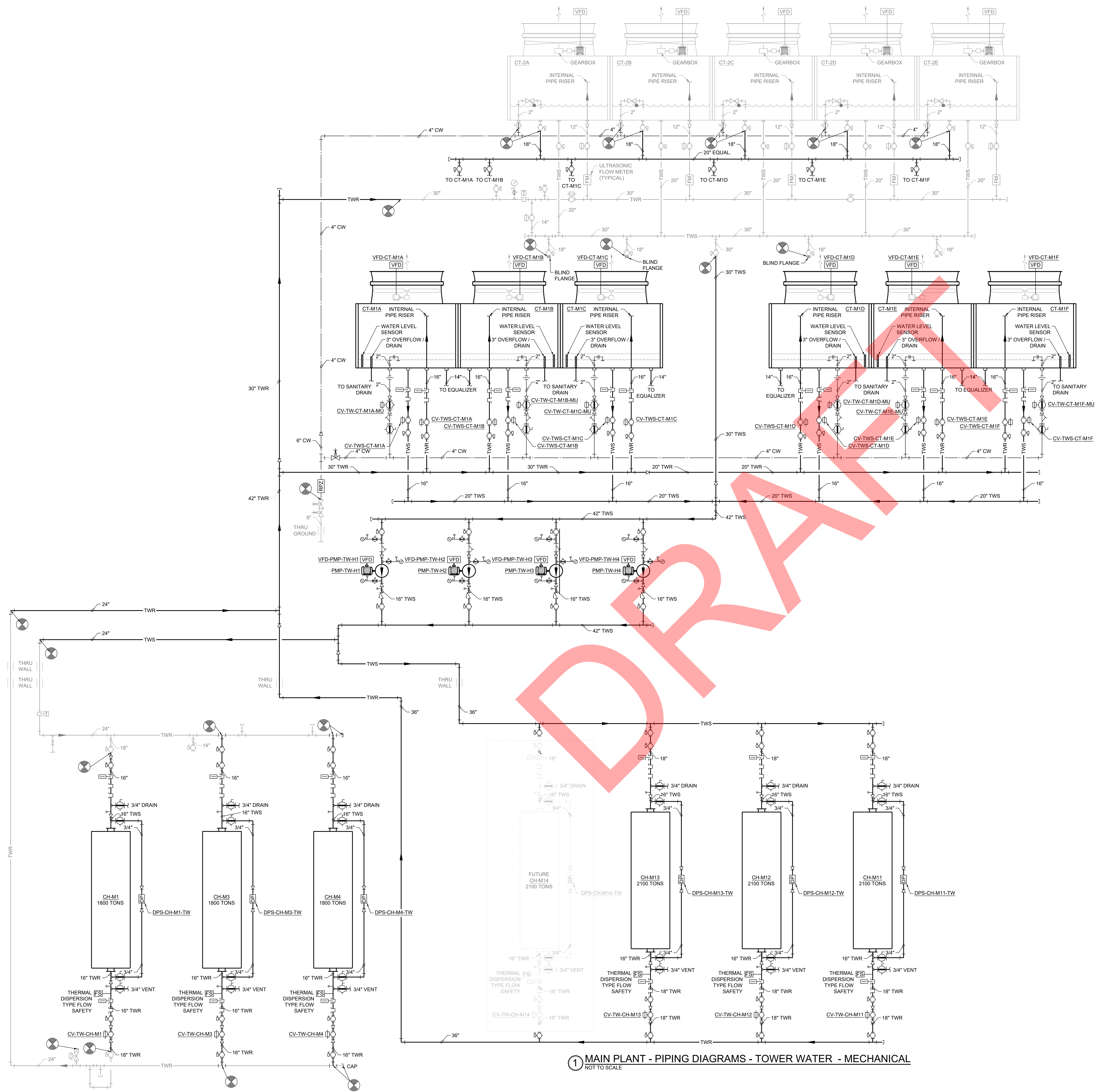

1 MAIN PLANT - PIPING DIAGRAMS - TOWER WATER - MECHANICAL
NOT TO SCALE

MARK	DATE	DESCRIPTION
ISSUE DATE:	09/17/21	
PROJECT NUMBER:	70-19-0025	
SHEET TITLE:		
MAIN PLANT - PIPING DIAGRAMS - TOWER WATER - MECHANICAL		
SHEET NUMBER:		
M430		

PRELIMINARY
FOR REVIEW ONLY

ENGINEER SEAL

INITIAL MODERNIZATION SOLUTION
LOUISIANA STATE UNIVERSITY
LOUISIANA ENERGY PARTNERS
BATON ROUGE, LOUISIANA

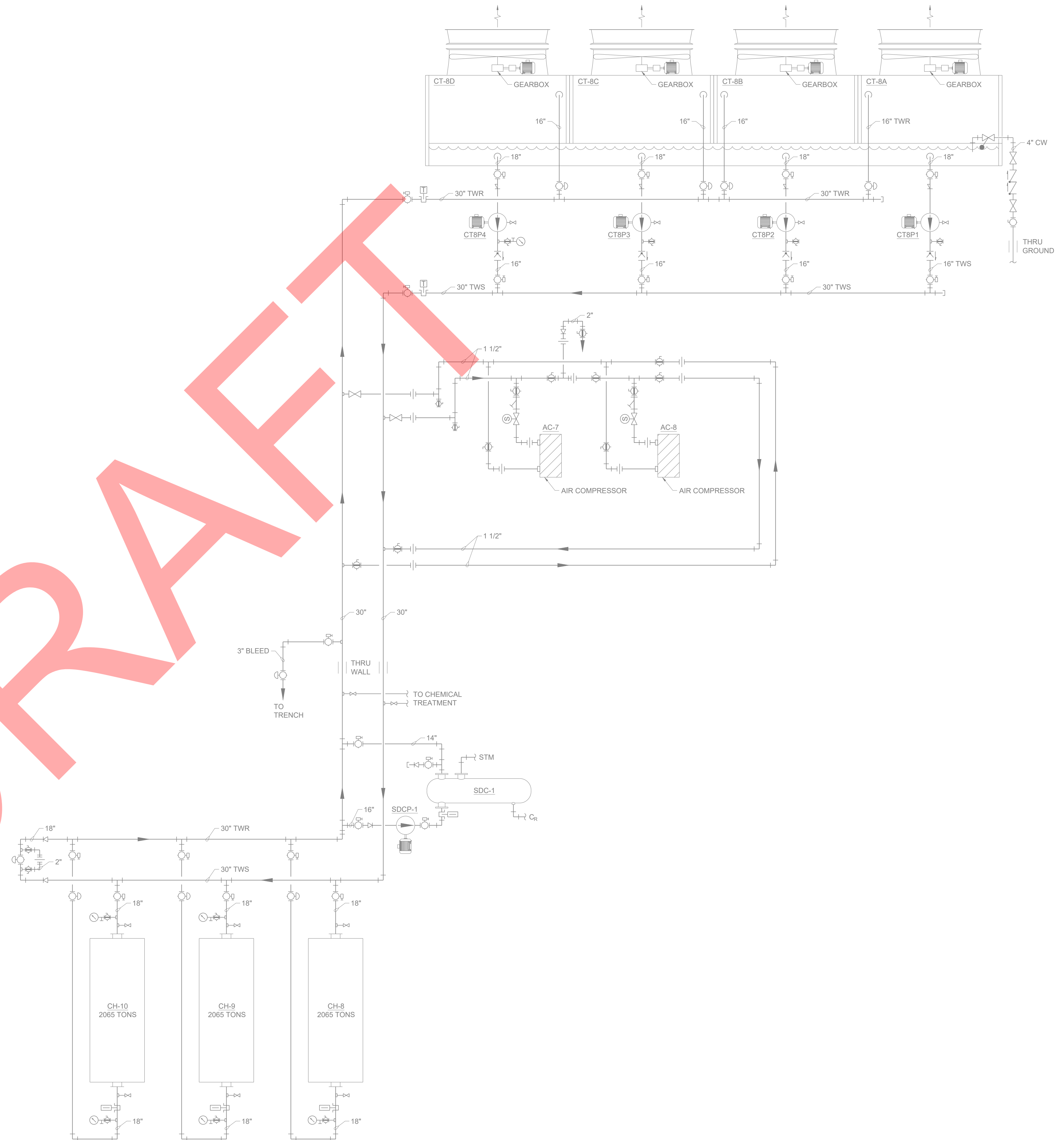

DRAFT

① MAIN PLANT - PIPING DIAGRAMS - TOWER WATER CONT. - MECHANICAL
NOT TO SCALE

MARK	DATE	DESCRIPTION
------	------	-------------

ISSUE DATE: 09/17/21

PROJECT NUMBER: 70-19-0025

SHEET TITLE:
MAIN PLANT - PIPING DIAGRAMS
- TOWER WATER CONT. -
MECHANICAL

SHEET NUMBER:
M431

PRELIMINARY
FOR REVIEW ONLY

ENGINEER SEAL

INITIAL MODERNIZATION SOLUTION
LOUISIANA STATE UNIVERSITY
LOUISIANA ENERGY PARTNERS
BATON ROUGE, LOUISIANA

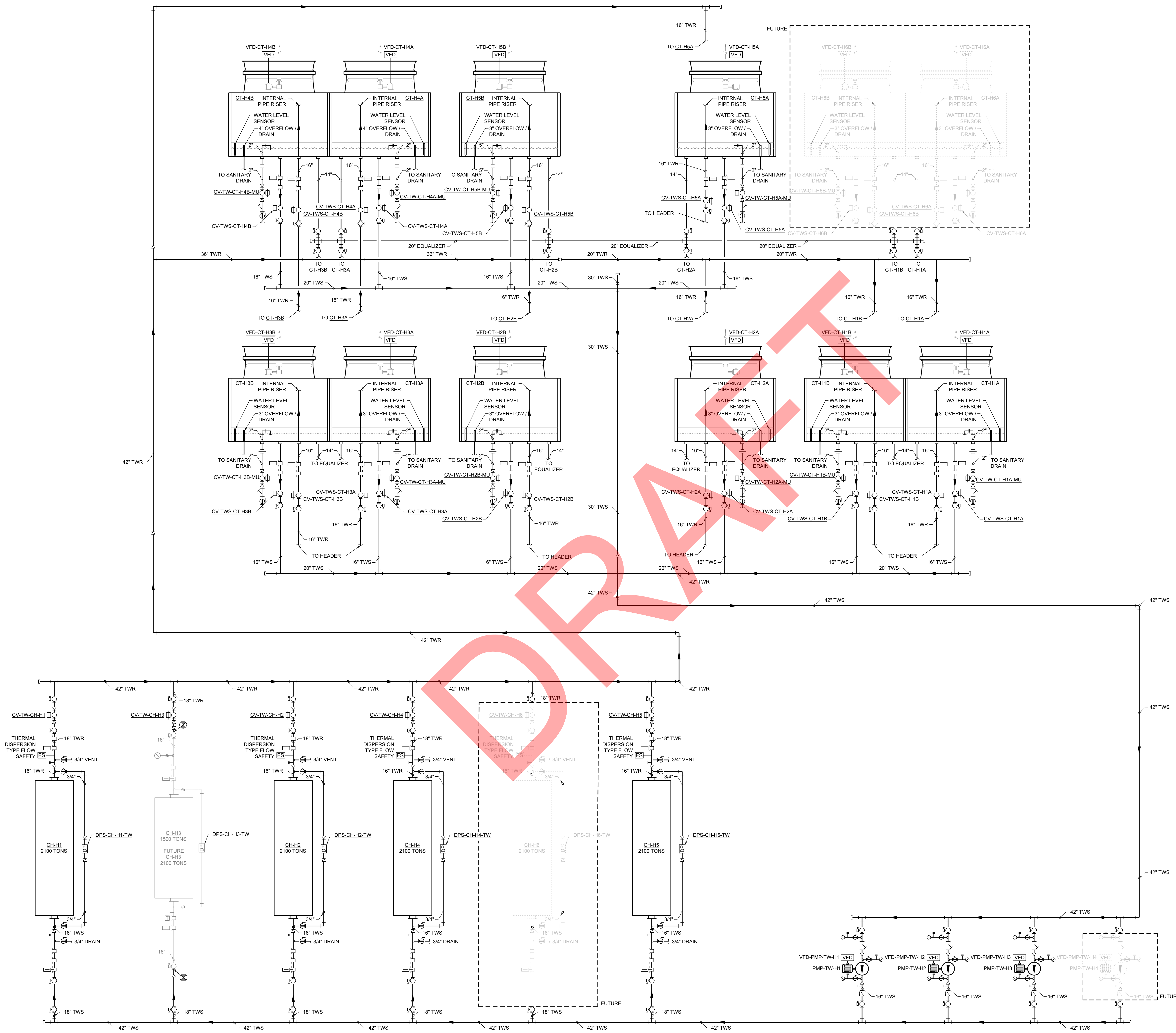

1 HIGHLAND PLANT - PIPING DIAGRAMS - TOWER WATER - MECHANICAL
NOT TO SCALE

MARK	DATE	DESCRIPTION
ISSUE DATE:	09/17/21	
PROJECT NUMBER:	70-19-0025	
SHEET TITLE:		
HIGHLAND PLANT - PIPING DIAGRAMS - TOWER WATER - MECHANICAL		

SHEET NUMBER:
M432

PRELIMINARY FOR REVIEW ONLY

ENGINEER SEAL

INITIAL MODERNIZATION SOLUTION
LOUISIANA STATE UNIVERSITY
LOUISIANA ENERGY PARTNERS
BATON ROUGE, LOUISIANA

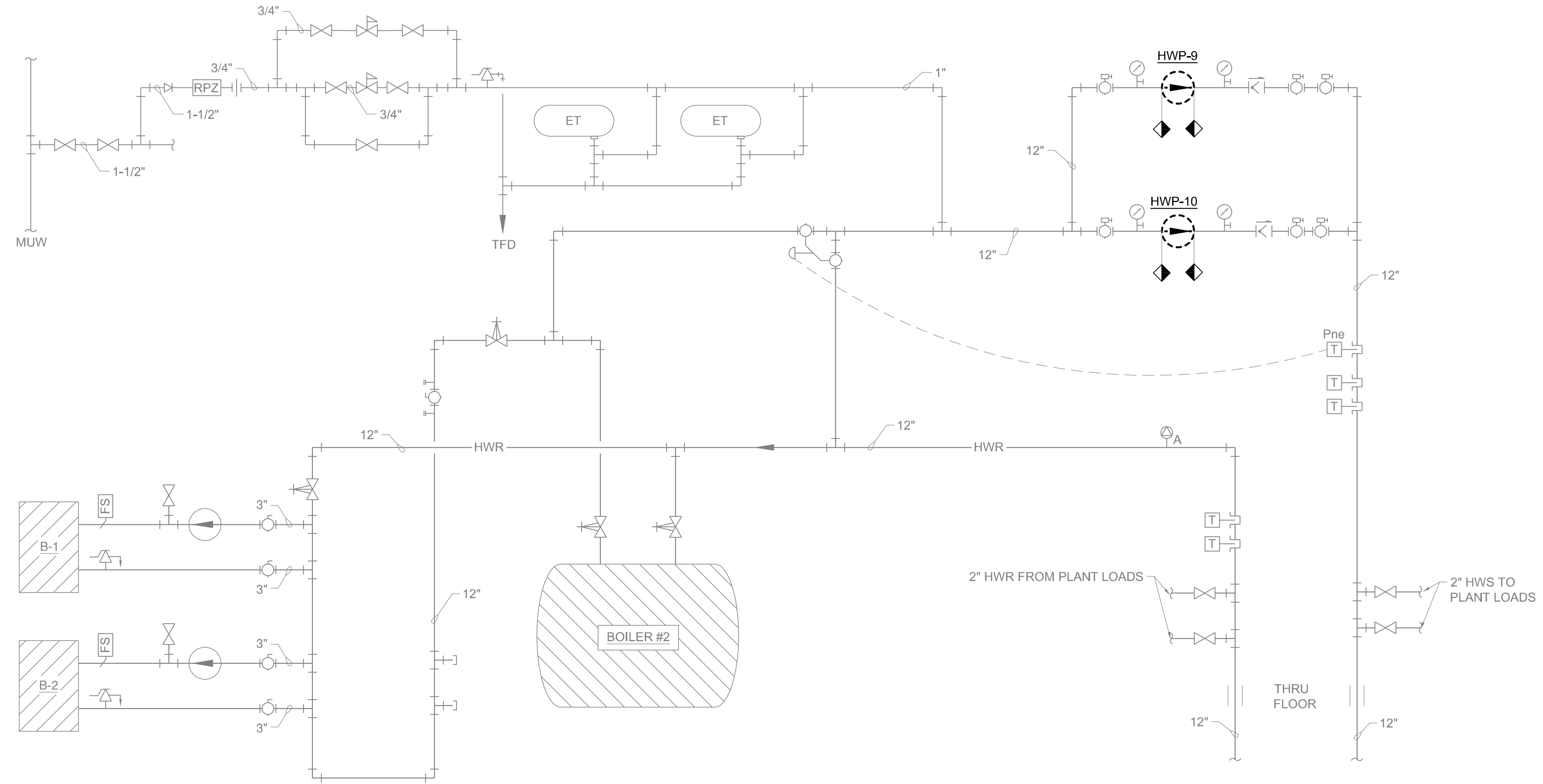

① HIGHLAND PLANT - PIPING DIAGRAMS - HEATING WATER - DEMOLITION

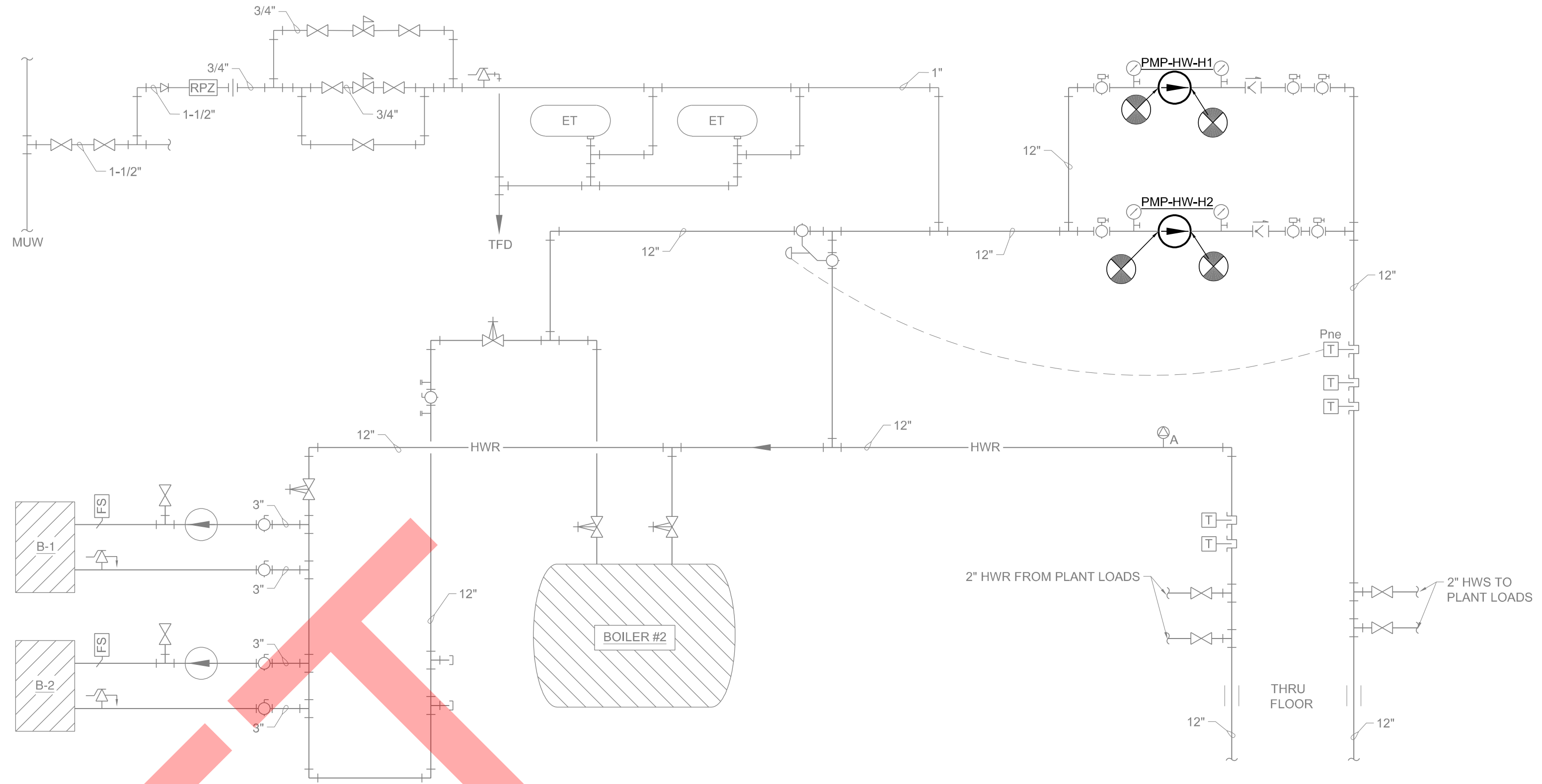

② HIGHLAND PLANT - PIPING DIAGRAMS - HEATING WATER - MECHANICAL

DRAFT

MARK	DATE	DESCRIPTION

ISSUE DATE: 09/17/21

PROJECT NUMBER: 70-19-0025

SHEET TITLE:
HIGHLAND PLANT - PIPING
DIAGRAMS - HEATING WATER -
EXISTING

SHEET NUMBER:
M440

GENERAL NOTES APPLICABLE TO ALL CONTROL DIAGRAMS:

- ALL CONTROL DEVICES SHOWN ON THE CONTROL DIAGRAMS ARE FURNISHED BY DIVISION 25 UNLESS OTHERWISE NOTED OR SPECIFIED.
- ALL COMPONENTS REQUIRED FOR THE SEQUENCES OF OPERATION, SHOWN ON THE CONTROL DIAGRAMS, DESCRIBED IN THE SPECIFICATION, OR AS REQUIRED FOR A PROPERLY OPERATING SYSTEM SHALL BE FURNISHED AND INSTALLED BY DIVISION 25 UNLESS OTHERWISE NOTED, SHOWN, OR SPECIFIED.
- DIVISION 25 IS RESPONSIBLE TO FURNISH, INSTALL, AND WIRE ALL COMPONENTS REQUIRED FOR INTEGRATION OF INFORMATION SHOWN TO BE ACCESSED BY THE EMS FROM OTHER SYSTEMS AND EQUIPMENT UNLESS OTHERWISE NOTED OR SPECIFIED.
- ALL POWER WIRING AND TRANSFORMERS FOR SENSORS, ACTUATORS, AND OTHER CONTROL DEVICES AS REQUIRED FOR THE EMS AND/OR DDC SYSTEMS TO FUNCTION PROPERLY, SHALL BE FURNISHED AND INSTALLED BY DIVISION 25 UNLESS OTHERWISE SHOWN, NOTED, OR SPECIFIED.
- ALL POWER WIRING FOR SENSORS, ACTUATORS, AND OTHER DEVICES SHALL BE FROM THE EQUIPMENT CONTROLLERS DDC PANELS OR THE FEP PANELS OF THE ASSOCIATED SYSTEM.
- ALL CONTROL, INTERLOCK, AND POWER WIRING SHALL BE INSTALLED PER THE DIVISION 26, LOCAL, STATE, AND NATIONAL CODES. RACEWAY SHALL BE INSTALLED PER THE ELECTRICAL SPECIFICATIONS.
- ALL CONTROL POINTS SHOWN ON THE CONTROL DIAGRAMS SHALL BE PROVIDED AND INTEGRATED INTO AN EMS SYSTEM GRAPHIC REPRESENTATIVE OF THE CONTROL DIAGRAMS.
- ALL CONTROL BANDS, SETPOINTS, SETPOINT LIMITS, SETPOINT INCREMENT VALUES, SETPOINT DECREMENT VALUES, ALARM LIMITS, AND OTHER PARAMETERS SHALL BE ADJUSTABLE FROM THE EMS.
- ALL CONTROL BANDS, SETPOINTS, TIME DELAYS, CONTROL LOOPS, AND OTHER PARAMETERS SHALL BE COMMISSIONED BY THE DIVISION 25 TO PROVIDE STABLE CONTROL OF ALL SYSTEMS.
- ALL SETPOINTS SHALL BE ADJUSTABLE FROM THE EMS SYSTEM GRAPHIC(S).
- SPACE SETPOINTS SHALL BE ADJUSTABLE FROM THE ROOM SENSOR UNLESS OTHERWISE SHOWN ON DRAWINGS OR SPECIFIED.
- THE EMS SYSTEM GRAPHICS SHALL BE LINKED WITH ASSOCIATED BUILDING FLOOR PLANS FROM THE SPACE SENSOR OR AREA SERVED.
- WHERE ONE SYSTEM IS ASSOCIATED WITH ANOTHER SYSTEM, THE SYSTEM GRAPHIC SHALL BE LINKED TO THE ASSOCIATED GRAPHIC AS WELL AS THE BUILDING FLOOR PLAN GRAPHIC. EXAMPLE - AN AIR HANDLING UNIT SYSTEM GRAPHIC SHALL BE LINKED TO THE CHILLED WATER SYSTEM GRAPHIC IN ADDITION TO BOTH BEING LINKED TO THE BUILDING FLOOR PLAN.
- THE BUILDING FLOOR PLAN SHALL DISPLAY THE SPACE TEMPERATURE AND THE ACTIVE SET POINT AT EACH SPACE SENSOR LOCATION WITH AREA SERVED DISPLAYED IN SEPARATE COLORS BASED ON THE CONDITION OF THE ZONE. AREAS WITH HUMIDITY AND PRESSURE CONTROL WILL ALSO HAVE THOSE VALUES DISPLAYED. EXAMPLE - ALARM, NORMAL, HIGH OR LOW TEMPERATURE, HIGH OR LOW HUMIDITY, ETC.
- ALL GRAPHICS (SCHEDULES, PLANS, AND DIAGRAMS) WILL INDICATED EQUIPMENT, POINTS, AND AREAS IN ALARM VIA A RED ALARM INDICATOR, RED TEXT, AND/OR A RED HIGHLIGHT. OVERRIDDEN POINTS WILL BE INDICATED WITH PURPLE.
- THE BUILDING FLOOR PLAN SHALL DISPLAY THE DUCTWORK AND THE PIPING LAYOUT. THE DUCTWORK AND PIPING SHALL BE ABLE TO TOGGLE ON AND OFF INDEPENDENTLY.
- ALL BUILDING FLOOR PLANS AND SYSTEM GRAPHICS SHALL DISPLAY OUTSIDE AIR TEMPERATURE AND HUMIDITY.
- THE FLOOR PLAN GRAPHICS SHALL BE LINKED TO A BUILDING GRAPHIC WITH A DIGITAL PHOTOGRAPH BACKGROUND OF THE ACTUAL BUILDING. DURING CONSTRUCTION A TEMPORARY GRAPHIC MAY BE USED THAT IS REPRESENTATIVE OF THE BUILDING.
- ALL GRAPHICS SHALL BE SUBMITTED IN COLOR WITH THE ATC SUBMITTAL. FAILURE TO INCLUDE ALL GRAPHICS IN SUBMITTAL SHALL BE CAUSE FOR REJECTION OF COMPLETE SUBMITTAL.
- VARIABLE FREQUENCY DRIVES ARE FURNISHED BY DIVISION 25, INSTALLED AND WIRED BY DIVISION 26. REFER TO VARIABLE FREQUENCY DRIVE SCHEDULE. VERIFY ALL EXISTING MOTOR HORSEPOWER AND ELECTRICAL RATINGS PRIOR TO SUBMITTAL AND ORDERING VARIABLE FREQUENCY DRIVES.
- POWER WIRING (PWR) FROM POWER SOURCE TO VARIABLE FREQUENCY DRIVES AND FROM VARIABLE FREQUENCY DRIVES TO MOTORS SHALL BE FURNISHED AND INSTALLED BY DIVISION 26.
- POWER WIRING (PWR) FROM POWER SOURCE TO MOTOR STARTERS AND FROM MOTOR STARTERS TO MOTORS SHALL BE FURNISHED AND INSTALLED BY DIVISION 26.
- POWER WIRING (PWR) FROM POWER SOURCE TO DDC, AND FEP PANELS SHALL BE FURNISHED AND INSTALLED BY THE DIVISION 26 UNLESS OTHERWISE NOTED ON DRAWINGS.
- GLOBAL DDC SYSTEM POINTS ARE DEFINED AS A SINGLE POINT USED IN ALL SYSTEMS IN A BUILDING OR CAMPUS TO MAINTAIN CONSISTENCY OF CONTROL ACTIONS THROUGHOUT THE BUILDING OR CAMPUS. EXAMPLE: OUTSIDE AIR TEMPERATURE POINT SAMPLED ON THE NORTH SIDE OF A BUILDING USED TO ENABLE/DISABLE AIRSIDE ECONOMIZER OPERATION THROUGHOUT THE BUILDING OR CAMPUS.
- CONTROL SEQUENCES ARE WRITTEN IN A GENERAL FORM INTENDED FOR IMPLEMENTATION BY ANY CONTROLS SYSTEM AND CONTRACTOR. DIVISION 25 SHALL REVIEW ALL SPECIFICATIONS AND CONTROL SEQUENCES FOR CONSTRUCTIBILITY, COMPATIBILITY, AND FEASIBILITY WITH ACTUAL CONDITIONS, BUILDING EQUIPMENT, AND THEIR OWN HARDWARE AND SOFTWARE LIMITATIONS AND CAPABILITIES. CONTROL SEQUENCES ARE INTENDED TO BE THE GENERAL STRUCTURE OF THE CONTRACTORS PROGRAMMING, BUT DO NOT NECESSARILY CONTAIN ALL THE REQUIRED DETAILS (LOOP AND TABLE STATEMENT TUNING, RAMP, LIMITS, ETC) AND BEST PRACTICES FOR THE FINAL PRODUCT. DIVISION 25 SHALL PROVIDE A COMPLETE, OPERABLE, AND TUNED CONTROL SYSTEM THAT MEETS THE INTENDED SEQUENCES AND THE SPECIFIC EQUIPMENT REQUIREMENTS. IF UPON IMPLEMENTATION IT IS DISCOVERED THAT ADDITIONAL PROGRAMMING IS REQUIRED TO MEET THE INTENDED DESIGN OF THE CONTROLS SYSTEM, DIVISION 25 SHALL PROVIDE THE ADDITIONAL PROGRAMMING AT NO ADDITIONAL COST. ALL PROGRAMMING (GRAPHICAL AND/OR TEXT BASED) SHALL BE REVIEWED WITH THE DIVISION 25 AS PART OF THE SUBMITTAL AND COMMISSIONING PROCESSES. DIVISION 25 WILL PROVIDE A SUBMITTAL OF THE GRAPHICAL AND/OR TEXT BASED PROGRAMMING FOR A SIDE TO SIDE COMPARISON WITH THE CONTRACT DOCUMENTS. THIS REVIEW WILL PART OF A SCHEDULED MEETING INVOLVING THE BAS CONTROL DESIGN TEAM, DIVISION 25, AND THE COMMISSIONING AGENT. LIBERTIES TAKEN BY DIVISION 25 ARE ALLOWED AFTER REVIEW AND APPROVAL FROM THE BAS DESIGN TEAM AND COMMISSIONING AGENT. ALL MODIFICATIONS SHALL BE RECORDED IN THE AS-BUILT DOCUMENTS. DIVISION 25 SHALL BE REQUIRED SET UP TRENDS AS INDICATED BY THE CONSTRUCTION DOCUMENTS, AND AS REQUIRED BY THE BAS DESIGN AND COMMISSIONING TEAM(S).
- ALL EQUIPMENT SHALL HAVE THE OPTION OF BEING EXCLUDED FROM INDIVIDUAL RESET STRATEGIES BY EQUIPMENT SUMMARY SCHEDULES AND BY EQUIPMENT GRAPHICS.
- ALL EQUIPMENT CONTROLLERS IN THIS PROJECT SHALL BE HARD WIRED. NO WIRELESS SENSORS SHALL BE ALLOWED UNLESS WRITTEN APPROVAL IS GIVEN BY THE OWNER AND EOR AND THE WIRELESS FREQUENCY BANDS ARE COORDINATED WITH THE OWNER.
- DIVISION 25 SHALL SET UP ALARM CRITERIA ACCORDING TO THE CONTROL DRAWINGS, SPECIFICATIONS, AND AS FOLLOWS:
LEVEL 1 ALARM: HIGHEST PRIORITY ALARM. ALL LOWER LEVEL PRIORITY ALARM RESPONSES APPLY PLUS ALL DESIGNATED HOSPITAL OPERATIONS PERSONNEL ARE NOTIFIED VIA TEXT.
LEVEL 2 ALARM: HIGH PRIORITY ALARM. ALL LOWER LEVEL PRIORITY ALARM RESPONSES APPLY PLUS ALL DESIGNATED HOSPITAL OPERATIONS PERSONNEL ARE NOTIFIED VIA TEXT AND EMAIL.
LEVEL 3 ALARM: HIGH PRIORITY ALARM. ALL LOWER LEVEL PRIORITY ALARM RESPONSES APPLY PLUS ALARM WARRANTS IMMEDIATE RESPONSE BY FACILITY PERSONNEL.
LEVEL 4 ALARM: MEDIUM PRIORITY ALARM. ALL LOWER LEVEL PRIORITY ALARM RESPONSES APPLY. ALARM WARRANTS A PROMPT RESPONSE FROM PERSONNEL. MAINLY ALARMS CONCERNING COMFORT ISSUES. ALARM AND ALARM LEVEL IS INDICATED VIA FLASHING ALARMS AND POP UPS AT THE BAS.
LEVEL 5 ALARM: LOW PRIORITY ALARM. ALARM IS LOGGED IN AN ALARM REVIEW SUMMARY.
AN ALARM SUMMARY SHALL BE CREATED FOR REVIEW OF HOSPITAL PERSONNEL DAILY. ALARM SUMMARY TO BE CAPABLE OF BEING SORTED BY ALARM LEVEL AND TIME OF ALARMS.
- DIVISION 25 SHALL SET UP OPERATOR CLEARANCE REQUIREMENTS ACCORDING TO THE CONTROL DRAWINGS, SPECIFICATIONS, AND AS FOLLOWS:
LEVEL 1: HIGHEST CLEARANCE REQUIRED. THESE SET POINTS CANNOT BE CHANGED OR OVERRIDDEN EXCEPT BY AN OPERATOR WITH THIS CLEARANCE.
LEVEL 2: HIGH CLEARANCE REQUIRED. THESE SET POINTS CAN ONLY BE CHANGED OR OVERRIDDEN BY SOMEONE WITH THIS LEVEL CLEARANCE OR HIGHER.
LEVEL 3: MEDIUM CLEARANCE REQUIRED. THESE SET POINTS CAN ONLY BE OVERRIDDEN BY SOMEONE WITH THIS LEVEL CLEARANCE, OR CHANGED BY SOMEONE WITH A HIGHER LEVEL CLEARANCE.
LEVEL 4: LOW CLEARANCE REQUIRED. THESE SET POINTS CAN ONLY BE OVERRIDDEN BY SOMEONE WITH THIS LEVEL CLEARANCE, OR CHANGED BY SOMEONE WITH A HIGHER LEVEL CLEARANCE.
LEVEL 5: NO CLEARANCE REQUIRED. THESE SET POINTS CAN BE CHANGED OR OVERRIDDEN BY ANYONE WITH BAS ACCESS. THIS IS ALSO THE CLEARANCE LEVEL FOR OCCUPANT CONTROL ITEMS SUCH AS THERMOSTATS.
- DIVISION 25 SHALL SET UP EQUIPMENT CRITERIA FOR ALL THERMOSTATICALLY CONTROLLED EQUIPMENT. CRITERIA IS USED IN LOAD SHED APPLICATIONS. CRITERIA LEVEL DESCRIPTIONS ARE AS FOLLOWS:
PRIORITY 0: HIGHEST PRIORITY. EQUIPMENT SERVING CRITICAL ZONES SHALL NOT BE INCLUDED IN ANY LOAD SHED CALCULATIONS (LABS, OPERATING ROOMS, PROCEDURE ROOMS, ETC.)
PRIORITY 1: HIGH PRIORITY. EQUIPMENT SERVING ZONES WITH IN-PATIENT SPACES OCCUPIED 24-7.
PRIORITY 2: MEDIUM PRIORITY. EQUIPMENT SERVING ZONES WITH OUT-PATIENT SPACES, UPPER LEVEL ADMINISTRATION.
PRIORITY 3: LOW PRIORITY. EQUIPMENT SERVING OFFICE SPACES, DATA CLOSETS, AND ELECTRICAL ROOMS.
PRIORITY 4: LOW PRIORITY. EQUIPMENT SERVING CORRIDORS, STORAGE CLOSETS, ETC.
AN OVERRIDE SUMMARY SHALL BE PROVIDED FOR ALL OVERRIDES AND SHALL BE CAPABLE OF BEING SORTED BY DATE, DURATION AND LEVEL OF PRIORITY.
- OVERRIDES SHALL BE CAPABLE OF TIMED RESETS.
- CONTROL LOGIC AND COMPONENTS SHALL BE ADJUSTED TO OBTAIN AT A MINIMUM THE FOLLOWING RESULTS. IF THESE RESULTS CANNOT BE OBTAINED BY "GUESSING" THE PARAMETERS, DIVISION 25 SHALL BE REQUIRED TO CALCULATE THEM AND PROVIDE THE CALCULATIONS WITH AS-BUILT DOCUMENTS.
A. TEMP CONTROL SHALL DEViate FROM SET POINT NO MORE THAN 0.2°F WITH PERIODS OF LESS THAN 1 MINUTE.
B. AIRFLOW CONTROL SHALL DEViate FROM SET POINT NO MORE THAN 2% OF THE SYSTEM SET POINT, OR SET POINT FOR THAT BRANCH OF SYSTEM, WITHIN A PERIOD OF LESS THAN 5 MINUTES.
C. HYDRONIC FLOW CONTROL SHALL DEViate FROM SET POINT NO MORE THAN 2% OF THE SYSTEM SET POINT, OR SET POINT FOR THAT BRANCH OF SYSTEM, WITHIN A PERIOD OF LESS THAN 5 MINUTES.
D. ACTUATORS SHALL NOT OSCILLATE MORE THAN 1% WITHIN A 5 MINUTE PERIOD.
E. VARIABLE FREQUENCY DRIVE COMMANDS SHALL NOT OSCILLATE MORE THAN 1% IN A 5 MINUTE PERIOD.
- THESE STANDARD SYSTEM DIAGRAMS AND SEQUENCES ARE DEVELOPED AS THE BASIS FOR DESIGN AND MAY NOT BE DIRECTLY APPLICABLE AS IS DUE TO EXISTING EQUIPMENT OR SYSTEM CAPABILITIES, OR DUE TO SYSTEM OR EQUIPMENT ARRANGEMENTS. IT IS THE RESPONSIBILITY OF THE ENGINEER OF RECORD TO MODIFY THESE DOCUMENTS AS REQUIRED FOR THE SPECIFIC CONDITIONS OF A PROJECT. REFER TO THE RFP DOCUMENTS FOR MODIFICATION PROCEDURES.

DIRECT DIGITAL CONTROL POINT TYPES

AI	DDC SYSTEM ANALOG INPUT POINT TYPE	GA	GLOBAL DDC SYSTEM ANALOG INPUT POINT TYPE
AO	DDC SYSTEM ANALOG OUTPUT POINT TYPE	GO	GLOBAL DDC SYSTEM ANALOG OUTPUT POINT TYPE
DI	DDC SYSTEM DIGITAL OR BINARY INPUT POINT TYPE	GO	GLOBAL DDC SYSTEM DIGITAL OR BINARY INPUT POINT TYPE
DO	DDC SYSTEM DIGITAL OR BINARY OUTPUT POINT TYPE	GO	GLOBAL DDC SYSTEM DIGITAL OR BINARY OUTPUT POINT TYPE

DIGITAL INPUT SENSORS

TLL	LOW LIMIT TEMPERATURE SWITCH WITH MANUAL RESET; FURNISHED, INSTALLED, AND WIRED BY DIVISION 25. DPDT SWITCH FOR HARDWIRE INTERLOCK TO FANS AND DDC MONITORING. REFER TO DETAIL H.	HSL	HIGH STATIC PRESSURE LIMIT SWITCH WITH MANUAL RESET; FURNISHED, INSTALLED, AND WIRED BY DIVISION 25. DPDT SWITCH FOR HARDWIRE INTERLOCK TO FANS AND DDC MONITORING. ORIENT FOR STATIC PRESSURE SENSING.
OCC	OCCUPANCY SENSOR; FURNISHED AND WIRED BY DIVISION 25. INSTALLED IN LIGHTING CIRCUIT BY DIVISION 26.	CSR	CURRENT SENSING RELAY; FURNISHED, INSTALLED, AND WIRED BY DIVISION 25.
ES	END SWITCH; FURNISHED, INSTALLED AND WIRED BY DIVISION 25 UNLESS OTHERWISE NOTED, SHOWN ON THE DRAWINGS, OR SPECIFIED.	FLDP SW	FILTER DIFFERENTIAL PRESSURE SWITCH; FURNISHED, INSTALLED, AND WIRED BY DIVISION 25.
WFS	WATER FLOW SWITCH SPECIFIED TO BE FURNISHED WITH HVAC EQUIPMENT; INSTALLED BY DIVISION 25; WIRED BY DIVISION 25.	LDP SW	DIFFERENTIAL PRESSURE SWITCH FOR WET MEDIA; FURNISHED, INSTALLED, AND WIRED BY DIVISION 25. PRESSURE TAPS IN PIPING BY DIVISION 23.
RM OCC	WALL MOUNTED ROOM OCCUPANCY SWITCH; FURNISHED, INSTALLED, AND WIRED BY DIVISION 25.	RM OCC	CEILING MOUNTED ROOM OCCUPANCY SWITCH; FURNISHED, INSTALLED, AND WIRED BY DIVISION 25.
MS	MOISTURE SENSOR; FURNISHED, INSTALLED, AND WIRED BY DIVISION 25.	PE SW	PRESSURE TO ELECTRIC SWITCH; FURNISHED, INSTALLED, PNEUMATIC PIPING, AND ELECTRICAL WIRING BY DIVISION 25.
KS	KEYED SWITCH; FURNISHED, INSTALLED AND WIRED BY DIVISION 25.	EFS	ELECTRONIC WATER FLOW SENSOR; FURNISHED, INSTALLED, AND WIRED BY DIVISION 25; INSTALLED IN PIPING BY DIVISION 23.

ANALOG INPUT SENSORS

T	DUCT TEMPERATURE SENSOR; FURNISHED, INSTALLED, AND WIRED BY DIVISION 25.	T	AVERAGING DUCT TEMPERATURE SENSOR; FURNISHED, INSTALLED, AND WIRED BY DIVISION 25. REFER TO DETAIL I.
T	OUTSIDE AIR TEMPERATURE SENSOR; FURNISHED, INSTALLED, AND WIRED BY DIVISION 25.	T	PIPE TEMPERATURE SENSOR; FURNISHED AND WIRED BY DIVISION 25. THERMAL WELL INSTALLED IN THE PIPING BY DIVISION 23.
VAC P	VACUUM PRESSURE SENSOR, FURNISHED, INSTALLED, AND WIRED BY DIVISION 25. TAP AND ISOLATION VALVE FURNISHED AND INSTALLED BY DIVISION 23.	AIR P	AIR PRESSURE SENSOR; FURNISHED, INSTALLED, AND WIRED BY DIVISION 25. TAP AND ISOLATION VALVE FURNISHED AND INSTALLED BY DIVISION 23.
T	ROOM TEMPERATURE SENSOR WITH SETPOINT, OVERRIDE PUSHBUTTON, AND DIGITAL DISPLAY; FURNISHED, INSTALLED, AND WIRED BY DIVISION 25.	GAS P	GAS PRESSURE SENSOR; FURNISHED, INSTALLED, AND WIRED BY DIVISION 25. TAP AND ISOLATION VALVE FURNISHED AND INSTALLED BY DIVISION 23. COORDINATE PRESSURE REQUIREMENTS.
T	ROOM TEMPERATURE SENSOR WITH SETPOINT, AND OVERRIDE PUSHBUTTON; FURNISHED, INSTALLED, AND WIRED BY DIVISION 25.	HI	ROOM HUMIDITY SENSOR WITH DIGITAL DISPLAY; FURNISHED, INSTALLED, AND WIRED BY DIVISION 25.
BSP	BUILDING STATIC PRESSURE SENSOR WITH DIGITAL DISPLAY; FURNISHED, INSTALLED, AND WIRED BY DIVISION 25. REFER TO DETAIL F.	H	ROOM HUMIDITY SENSOR; FURNISHED, INSTALLED, AND WIRED BY DIVISION 25.
DPS	DIFFERENTIAL PRESSURE SENSOR FOR WET MEDIA WITH DIGITAL DISPLAY; FURNISHED, INSTALLED, AND WIRED BY DIVISION 25. ISOLATION VALVES AND TAPS IN PIPING BY DIVISION 23.	DSP	DUCT STATIC PRESSURE SENSOR WITH DIGITAL DISPLAY; FURNISHED, INSTALLED AND WIRED BY DIVISION 25.
H	DUCT RELATIVE HUMIDITY SENSOR; FURNISHED, INSTALLED, AND WIRED BY DIVISION 25.	DPS	DIFFERENTIAL PRESSURE SENSOR WITH DIGITAL DISPLAY; FURNISHED, INSTALLED AND WIRED BY DIVISION 25.
PS	STRAP ON TEMPERATURE SENSOR; FURNISHED, INSTALLED, AND WIRED BY DIVISION 25.	PS	PRESSURE SENSOR FOR WET MEDIA WITH DIGITAL DISPLAY; FURNISHED, INSTALLED, AND WIRED BY DIVISION 25. ISOLATION VALVES AND TAPS IN PIPING BY DIVISION 23.
FM LIQ	LIQUID FLOW METER - FURNISHED AND WIRED BY DIVISION 25. INSTALLED IN PIPING BY DIVISION 23.	CO2	ROOM CARBON DIOXIDE SENSOR WITH DIGITAL DISPLAY; FURNISHED, INSTALLED, AND WIRED BY DIVISION 25.
RPS	ROOM PRESSURE SENSOR; FURNISHED, INSTALLED, AND WIRED BY DIVISION 25.	CO2	DUCT CARBON DIOXIDE SENSOR WITH DIGITAL DISPLAY; FURNISHED, INSTALLED, AND WIRED BY DIVISION 25.
RPM	ROOM PRESSURE MONITOR; FURNISHED, INSTALLED, AND WIRED BY DIVISION 25.	FM GAS	GAS FLOW METER - FURNISHED AND WIRED BY DIVISION 25. INSTALLED IN PIPING BY DIVISION 23.
HOOD PROX	FUME HOOD PROXIMITY SENSOR; FURNISHED, INSTALLED, AND WIRED BY DIVISION 25.	FHC	FUME HOOD CONTROL WITH DISPLAY AND KEYPAD; FURNISHED, INSTALLED, AND WIRED BY DIVISION 25.

OUTPUT DEVICES

VA	CONTROL VALVE (2-WAY) WITH ELECTRIC OR ELECTRONIC ACTUATOR; FURNISHED AND WIRED BY DIVISION 25. INSTALLED IN PIPING BY DIVISION 23.	VA ES	CONTROL VALVE (2-WAY) WITH ELECTRONIC ACTUATOR AND INTEGRAL END SWITCH; FURNISHED AND WIRED BY DIVISION 25. INSTALLED IN PIPING BY DIVISION 23.
VA	CONTROL VALVE (3-WAY) ELECTRIC OR ELECTRONIC; FURNISHED AND WIRED BY DIVISION 25. INSTALLED IN PIPING BY DIVISION 23.	VA ES	CONTROL VALVE (3-WAY) WITH ELECTRONIC ACTUATOR AND INTEGRAL END SWITCH; FURNISHED AND WIRED BY DIVISION 25. INSTALLED IN PIPING BY DIVISION 23.
VA	BUTTERFLY CONTROL VALVE (2-WAY) WITH ELECTRONIC ACTUATOR; FURNISHED AND WIRED BY DIVISION 25. INSTALLED IN PIPING BY DIVISION 23.	VA ES	BUTTERFLY CONTROL VALVE (2-WAY) WITH ELECTRONIC ACTUATOR AND INTEGRAL END SWITCH; FURNISHED AND WIRED BY DIVISION 25. INSTALLED IN PIPING BY DIVISION 23.
VA	BUTTERFLY CONTROL VALVE (3-WAY) WITH ELECTRONIC ACTUATOR; FURNISHED AND WIRED BY DIVISION 25. INSTALLED IN PIPING BY DIVISION 23.	VA ES	BUTTERFLY CONTROL VALVE (3-WAY) WITH ELECTRONIC ACTUATOR AND INTEGRAL END SWITCH; FURNISHED AND WIRED BY DIVISION 25. INSTALLED IN PIPING BY DIVISION 23.
DA	DAMPER ACTUATOR; FURNISHED, INSTALLED, AND WIRED BY DIVISION 25 UNLESS OTHERWISE NOTED ON DRAWINGS OR IN SPECIFICATIONS.	DA ES	DAMPER ACTUATOR WITH INTEGRAL END SWITCHES; FURNISHED, INSTALLED, AND WIRED BY DIVISION 25 UNLESS OTHERWISE NOTED ON DRAWINGS OR IN SPECIFICATIONS.
SDA	SMOKE DAMPER ACTUATOR(S); FURNISHED AND INSTALLED BY DIVISION 23. REFER TO DETAIL G.	SDA ES	SMOKE DAMPER ACTUATOR(S) WITH INTEGRAL END SWITCH; FURNISHED AND INSTALLED BY DIVISION 23. REFER TO DETAIL G.
FSDA	FIRE/SMOKE DAMPER ACTUATOR(S); FURNISHED AND INSTALLED BY DIVISION 23. REFER TO DETAIL G.	FSDA ES	FIRE/SMOKE DAMPER ACTUATOR(S) WITH INTEGRAL END SWITCH; FURNISHED AND INSTALLED BY DIVISION 23. REFER TO DETAIL G.
EPT	ELECTRIC TO PRESSURE TRANSDUCER; FURNISHED, INSTALLED, PIPED, AND WIRED BY DIVISION 25.	AFMS ATC	AIR FLOW MEASURING STATION; FURNISHED AND WIRED BY DIVISION 25; INSTALLED BY DIVISION 23.
AFMS ATC	AIR FLOW MEASURING STATION WITH INTEGRAL CONTROL DAMPER; FURNISHED AND WIRED BY DIVISION 25; INSTALLED BY THE DIVISION 23.	AFMS ATC	EXHAUST AIRFLOW MEASURING DEVICE; FURNISHED BY DIVISION 25; INSTALLED BY DIVISION 23; DIFFERENTIAL PRESSURE SENSOR FURNISHED AND INSTALLED BY DIVISION 25.

LEGEND

	THREE PHASE POWER WIRING; FURNISHED AND INSTALLED BY DIVISION 26 (PWR)
	SINGLE PHASE POWER WIRING; FURNISHED AND INSTALLED BY DIVISION 26 (PWR)
	CONTROL AND INTERLOCK WIRING, FURNISHED AND INSTALLED BY DIVISION 25 (ILK)
	EMS ETHERNET LAN COMMUNICATION WIRING, FURNISHED AND INSTALLED BY DIVISION 25 (EMS LAN)
	EMS SUB-NETWORK COMMUNICATION WIRING, FURNISHED AND INSTALLED BY DIVISION 25 (EMS SN)
	ROOM SENSOR COMMUNICATION WIRING, FURNISHED AND INSTALLED BY DIVISION 25 (EMS RS)
	COMMUNICATION WIRING FOR OTHER HVAC SYSTEMS, FURNISHED AND INSTALLED BY DIVISION 25 (EMS OTH)
	PNEUMATIC CONTROL TUBING, FURNISHED AND INSTALLED BY DIVISION 25
	CONTROL PIPING, FURNISHED AND INSTALLED BY DIVISION 25
	LOCAL AREA NETWORK DATA PORT DROP, FURNISHED AND INSTALLED BY DIVISION 26
	NORMALLY CLOSED - POWERED OPEN
	NORMALLY OPEN - POWERED CLOSED
	NORMALLY CLOSED - POWERED OPEN RELAY CONTACT
	NORMALLY OPEN - POWERED CLOSED RELAY CONTACT
	TO FLOOR DRAIN
	PNEUMATIC CONTROL SUPPLY AIR CONNECTION
	EMERGENCY (ESSENTIAL) ELECTRICAL POWER

CONTROL SYMBOL LEGEND

OTHER CONTROL DEVICES

FEP	FIELD EQUIPMENT PANEL (FEP); FURNISHED AND INSTALLED BY DIVISION 25. POWER WIRING TO FEP BY DIVISION 26.	DDC	DIRECT DIGITAL CONTROL PANEL (DDC); FURNISHED AND INSTALLED BY DIVISION 25. POWER WIRING TO DDC PANEL BY DIVISION 26.
	FILTER GAGE; FURNISHED WITH FILTERS; INSTALLATION AND INSTRUMENT PIPING BY DIVISION 25.		BALL-IN-TUBE VISUAL OFFSET INDICATOR FURNISHED AND INSTALLED BY DIVISION 25.

CONTROL DEVICES FURNISHED BY OTHER TRADES:

HHLEQ	HUMIDITY HIGH LIMIT SENSOR; FURNISHED WITH THE STEAM HUMIDIFIER; INSTALLED AND WIRED BY DIVISION 25.		CENTRIFUGAL FAN INLET BELL HOUSING AIRFLOW MEASURING STATION FURNISHED AND INSTALLED BY THE FAN MANUFACTURER.
LVLS	FUEL OIL SYSTEM LEVEL SENSOR; FURNISHED AND INSTALLED BY THE FUEL OIL SYSTEM SUPPLIER. WIRED BY DIVISION 25.		CENTRIFUGAL FAN INLET BELL HOUSING AIRFLOW MEASURING STATION FURNISHED AND INSTALLED BY THE FAN MANUFACTURER.
SV FOS	FUEL OIL SYSTEM SOLENOID VALVE; FURNISHED AND INSTALLED BY THE FUEL OIL SYSTEM SUPPLIER. WIRED BY DIVISION 25.	LVL EG	EMERGENCY GENERATOR FUEL OIL LEVEL SENSOR; FACTORY FURNISHED, INSTALLED, AND WIRED WITH THE EMERGENCY GENERATOR.
FS	FUEL OIL SYSTEM FLOW SWITCH; FURNISHED AND INSTALLED WITH FUEL OIL SYSTEM BY DIVISION 23. WIRED BY DIVISION 25.	SV EG	EMERGENCY GENERATOR SOLENOID VALVE; FURNISHED AND INSTALLED BY THE FUEL OIL SYSTEM SUPPLIER. WIRED BY DIVISION 25.
AFMS EQ	AIR FLOW MEASURING STATION; FURNISHED AND INSTALLED BY THE AIR HANDLING UNIT MANUFACTURER. WIRING TO THE DDC PANEL BY DIVISION 25. POWER WIRING BY DIVISION 26.	LEAK EG	EMERGENCY GENERATOR FUEL OIL LEAK DETECTOR; FACTORY FURNISHED, INSTALLED, AND WIRED WITH THE EMERGENCY GENERATOR.
VA EQ	CONTROL VALVE (2-WAY) WITH ELECTRIC OR ELECTRONIC ACTUATOR; FURNISHED WITH EQUIPMENT (EQ); WIRED BY DIVISION 25; INSTALLED IN PIPING BY DIVISION 23.	T EQ	EQUIPMENT STRAP ON TEMPERATURE SENSOR; FURNISHED WITH EQUIPMENT; INSTALLED, AND WIRED BY DIVISION 25.
AFMS EQ	AIR FLOW MEASURING STATION WITH INTEGRAL CONTROL DAMPER; FURNISHED AND INSTALLED BY THE AIR HANDLING UNIT MANUFACTURER. WIRING TO DDC SYSTEM BY DIVISION 25.	AFMS SM	AIR FLOW MEASURING STATION; FURNISHED AND INSTALLED BY DIVISION 23. WIRING FROM THE AFMS TO THE DDC PANEL BY DIVISION 25. POWER WIRING BY DIVISION 26.
FAR SMK	FIRE ALARM PROGRAMMABLE RELAY (FAR) FOR SMOKE PURGE OPERATION (SMK); FURNISHED, INSTALLED, AND PROGRAMMED BY DIVISION 28. FAR SHALL BE LOCATED IN SAME ROOM AS HVAC EQUIPMENT SERVED PER NFPA. ALL WIRING FROM FAR TO FIRE ALARM SYSTEM BY DIVISION 28. INTERLOCK WIRING FROM FAR TO ATC PANEL BY DIVISION 25.	NC	CONTROL DAMPER; FURNISHED AND INSTALLED BY DIVISION 23. DAMPER ACTUATOR FURNISHED AND INSTALLED AND WIRED BY DIVISION 25.
DSD	DUCT MOUNTED SMOKE DETECTOR(S); FURNISHED, INSTALLED, AND WIRED BY DIVISION 28 AS PART OF THE FIRE ALARM SYSTEM.	AFMS SM	AIR FLOW MEASURING STATION WITH INTEGRAL CONTROL DAMPER; FURNISHED AND INSTALLED BY DIVISION 23.
FAR	FIRE ALARM PROGRAMMABLE RELAY (FAR); FURNISHED, INSTALLED, AND PROGRAMMED BY DIVISION 28. FAR SHALL BE LOCATED IN SAME ROOM AS HVAC EQUIPMENT SERVED PER NFPA. ALL WIRING FROM FAR TO FIRE ALARM SYSTEM BY DIVISION 28. INTERLOCK WIRING FROM FAR TO ATC PANEL BY DIVISION 25.		

ABBREVIATIONS

AHU	AIR HANDLING UNIT	IUH	INDUCTION UNIT HEATER
BCCO	BLOWER COIL UNIT COOLING ONLY	MA	MIXED AIR
BCU	BLOWER COIL UNIT	MAH	MIXED AIR HUMIDITY
CVET	CONSTANT VOLUME EXHAUST TERMINAL	MAT	MIXED AIR TEMPERATURE
CVRT	CONSTANT VOLUME RETURN TERMINAL	SETP	SETPOINT
CVST	CONSTANT VOLUME SUPPLY TERMINAL	OA	OUTSIDE AIR
CWR	CONDENSER RETURN	OAF	OUTSIDE AIRFLOW
CWS	CONDENSER SUPPLY	OAH	OUTSIDE AIR HUMIDITY
CHR	CHILLED WATER RETURN	OAT	OUTSIDE AIR TEMPERATURE (DRY BULB)
CHS	CHILLED WATER SUPPLY	PFST	PARALLEL FAN SUPPLY TERMINAL
DHS	DISCHARGE AIR HUMIDITY	RA	RETURN AIR
DAT	DISCHARGE AIR TEMPERATURE	RAF	RETURN AIRFLOW
DB	DRY BULB	RAH	RETURN AIR HUMIDITY
DCHR	DISTRICT CHILLED WATER RETURN	RAT	RETURN AIR TEMPERATURE
DCHS	DISTRICT CHILLED WATER SUPPLY	RH	RELATIVE HUMIDITY
DHWS	DISTRICT HEATING WATER SUPPLY	SA	SUPPLY AIR
DHWR	DISTRICT HEATING WATER RETURN	SAF	SUPPLY AIRFLOW
DP	DIFFERENTIAL PRESSURE	SAT	SUPPLY AIR TEMPERATURE
FCCO	FAN COIL UNIT COOLING ONLY	SFST	SERIES FAN SUPPLY TERMINAL
FCHO	FAN COIL UNIT HEATING ONLY	SP	STATIC PRESSURE
FCU	FAN COIL UNIT	UH	UNIT HEATER
HWR	HEATING WATER RETURN	VVET	VARIABLE VOLUME EXHAUST TERMINAL
HWS	HEATING WATER SUPPLY	VVRT	VARIABLE VOLUME RETURN TERMINAL
ILK	INTERLOCK	VVST	VARIABLE VOLUME SUPPLY TERMINAL
		WB	WET BULB

SHEET ABBREVIATIONS

SD	STANDARD DETAIL
SS	STANDARD SYSTEM
SME	STANDARD MATERIALS AND EQUIPMENT

Bernhard TME Engineering
 1 ALLIED DRIVE, BUILDING 2 SUITE 2600
 LITTLE ROCK, AR 72202
 Phone: (501) 666-6778
 Fax: (501) 663-8888
 bernhard.com
 (COA #3930)

PRELIMINARY FOR REVIEW ONLY
 ENGINEER SEAL

INITIAL MODERNIZATION SOLUTION
LOUISIANA STATE UNIVERSITY
LOUISIANA ENERGY PARTNERS
 BATON ROUGE, LOUISIANA

MARK	DATE	DESCRIPTION
ISSUE DATE:	09/17/21	
PROJECT NUMBER:	70-19-0025	

SHEET TITLE:
CONTROLS LEGEND

SHEET NUMBER:
ATC001

**PRELIMINARY
FOR REVIEW ONLY**

ENGINEER SEAL

**INITIAL MODERNIZATION SOLUTION
LOUISIANA STATE UNIVERSITY
LOUISIANA ENERGY PARTNERS**
BATON ROUGE, LOUISIANA

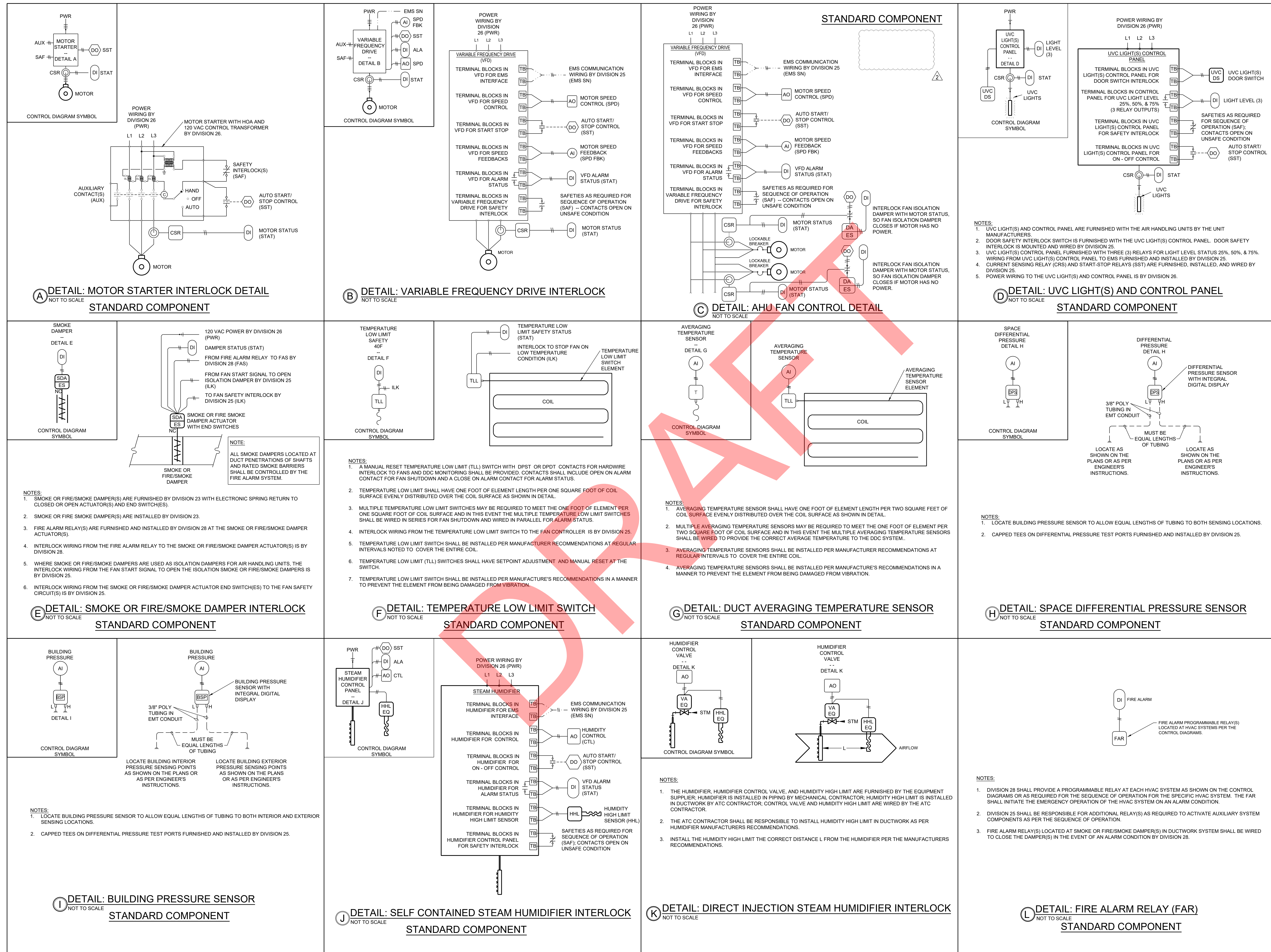

MARK	DATE	DESCRIPTION
ISSUE DATE:	09/17/21	
PROJECT NUMBER:	70-19-0025	
SHEET TITLE: CONTROLS DETAILS 1		

PRELIMINARY
FOR REVIEW ONLY

ENGINEER SEAL

INITIAL MODERNIZATION SOLUTION
LOUISIANA STATE UNIVERSITY
LOUISIANA ENERGY PARTNERS
BATON ROUGE, LOUISIANA

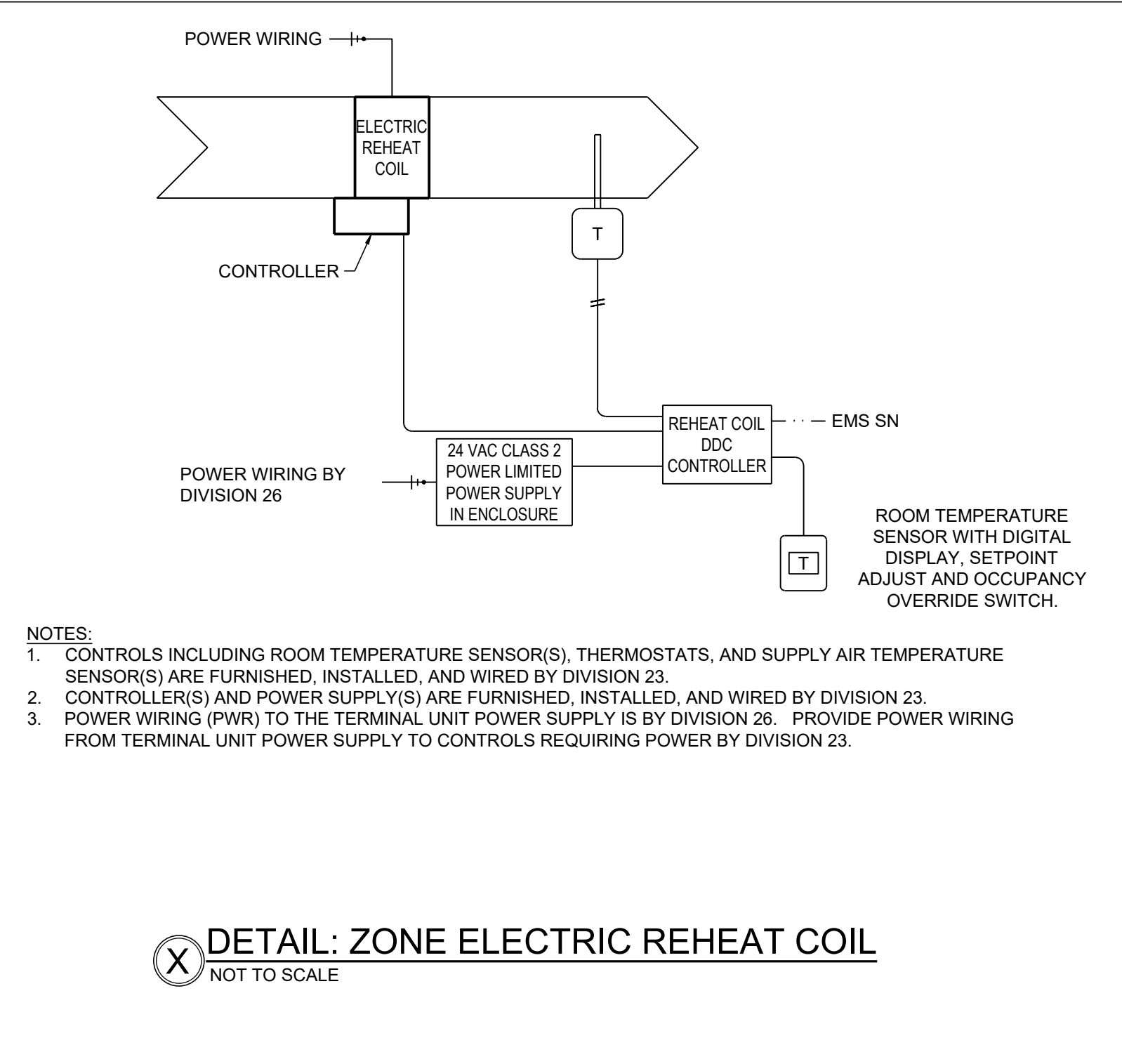
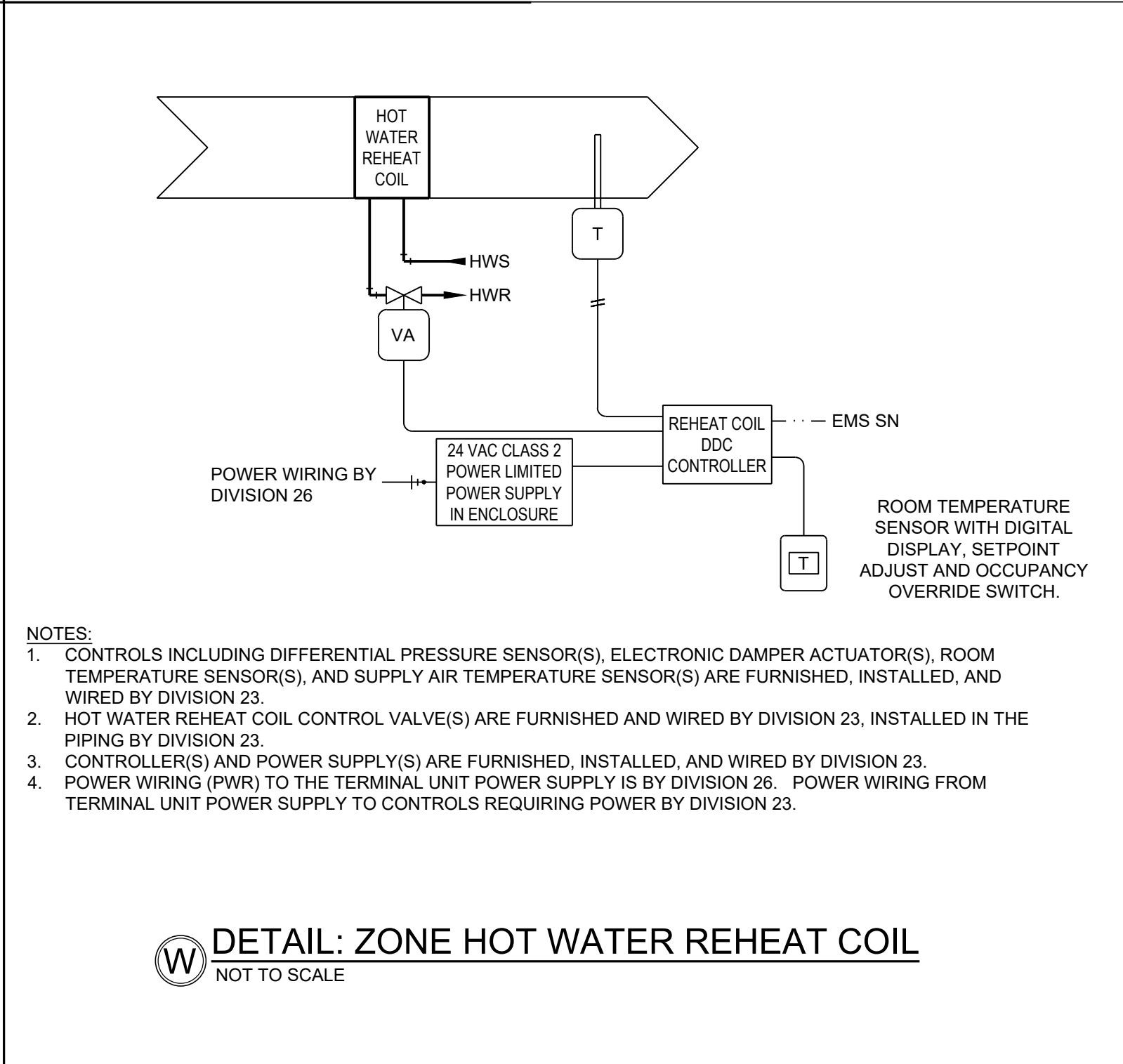
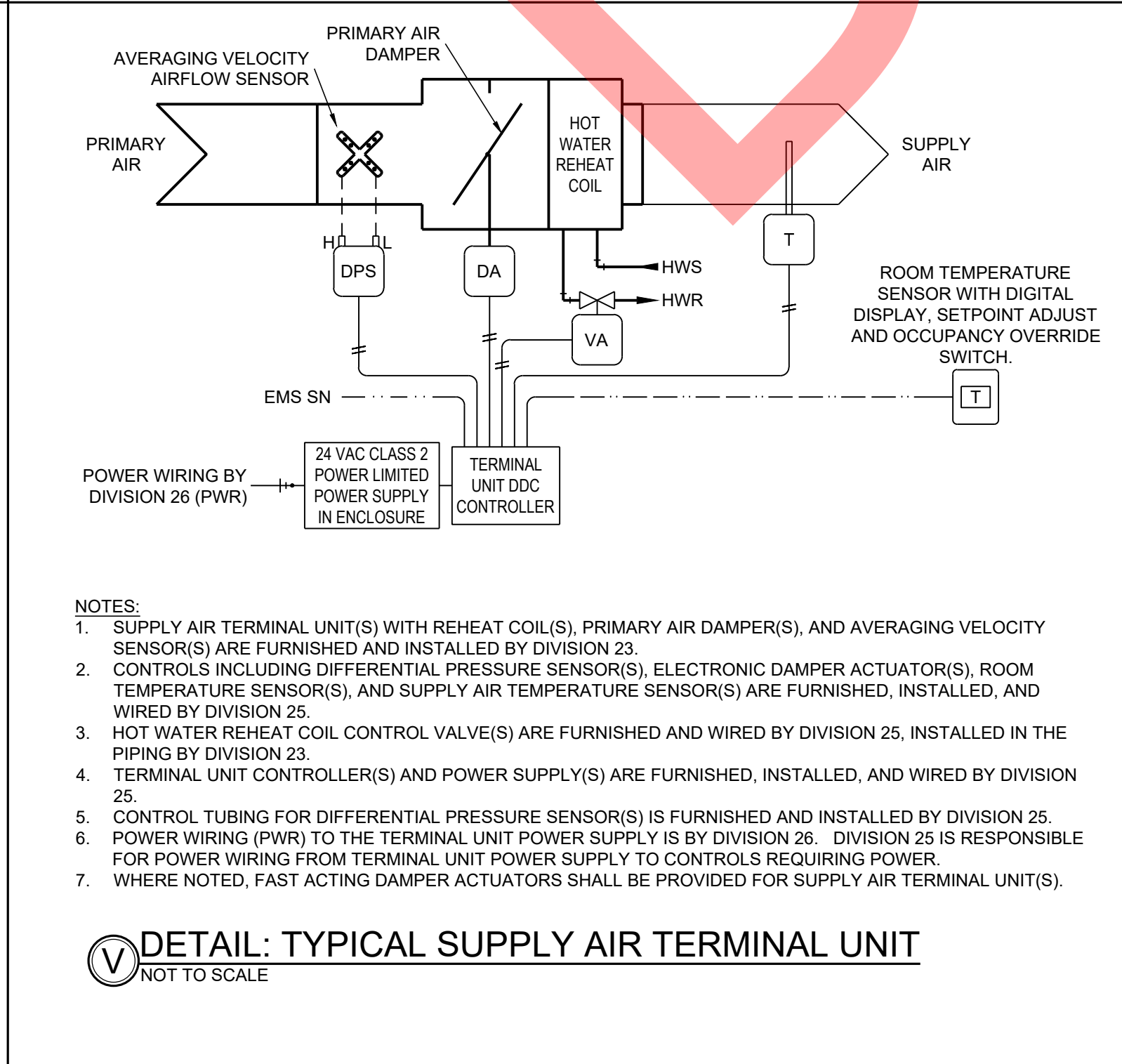
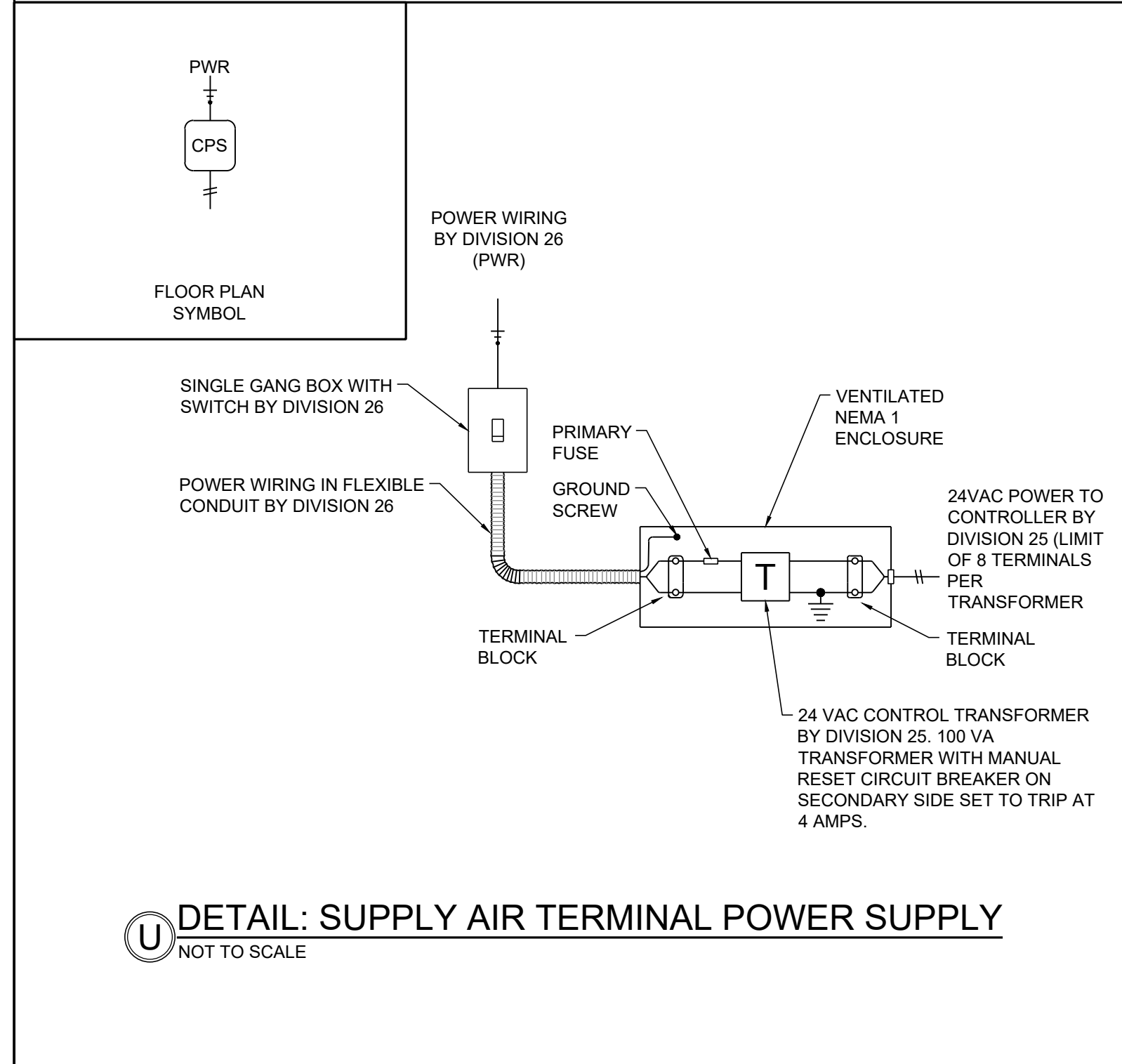
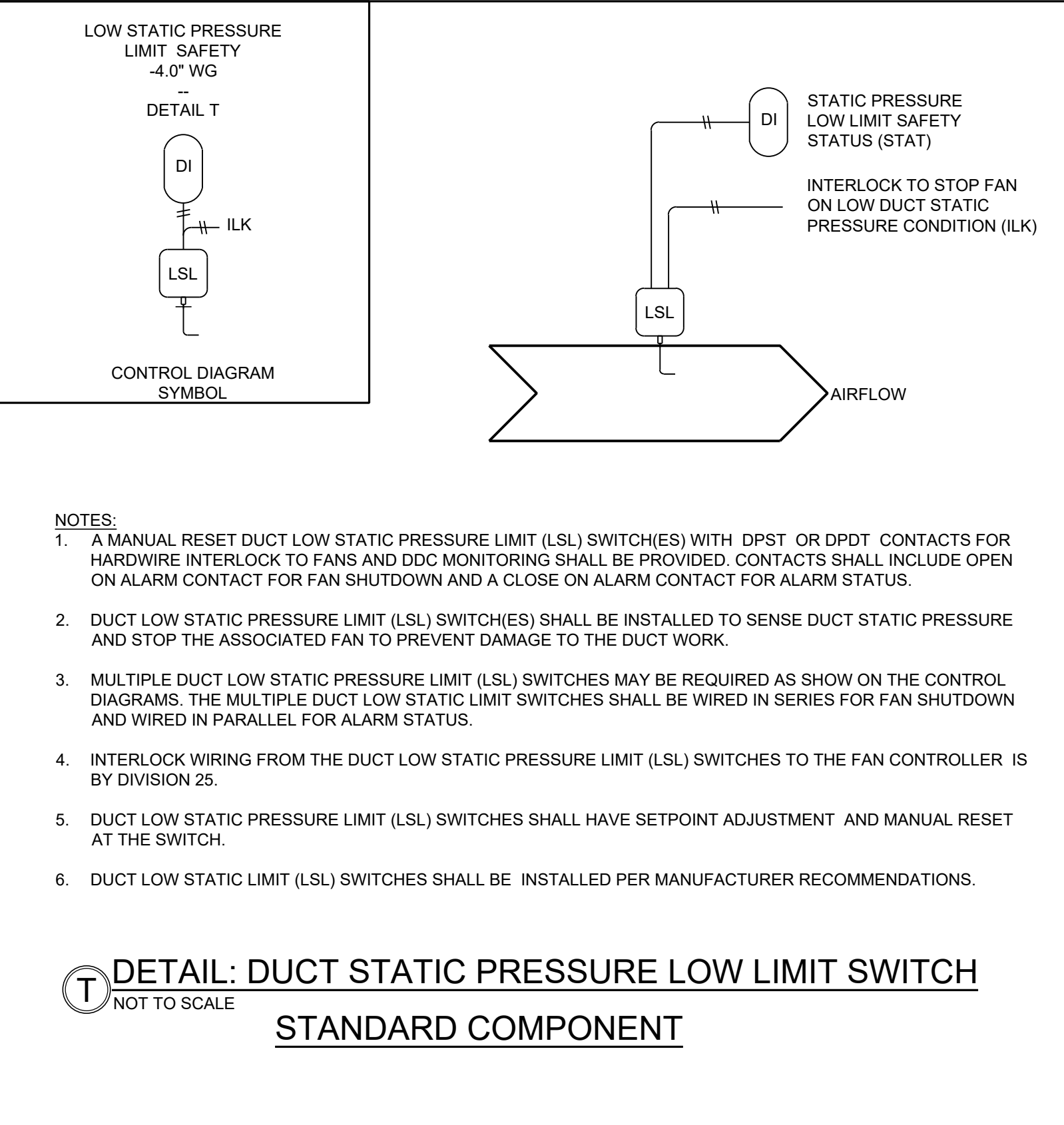
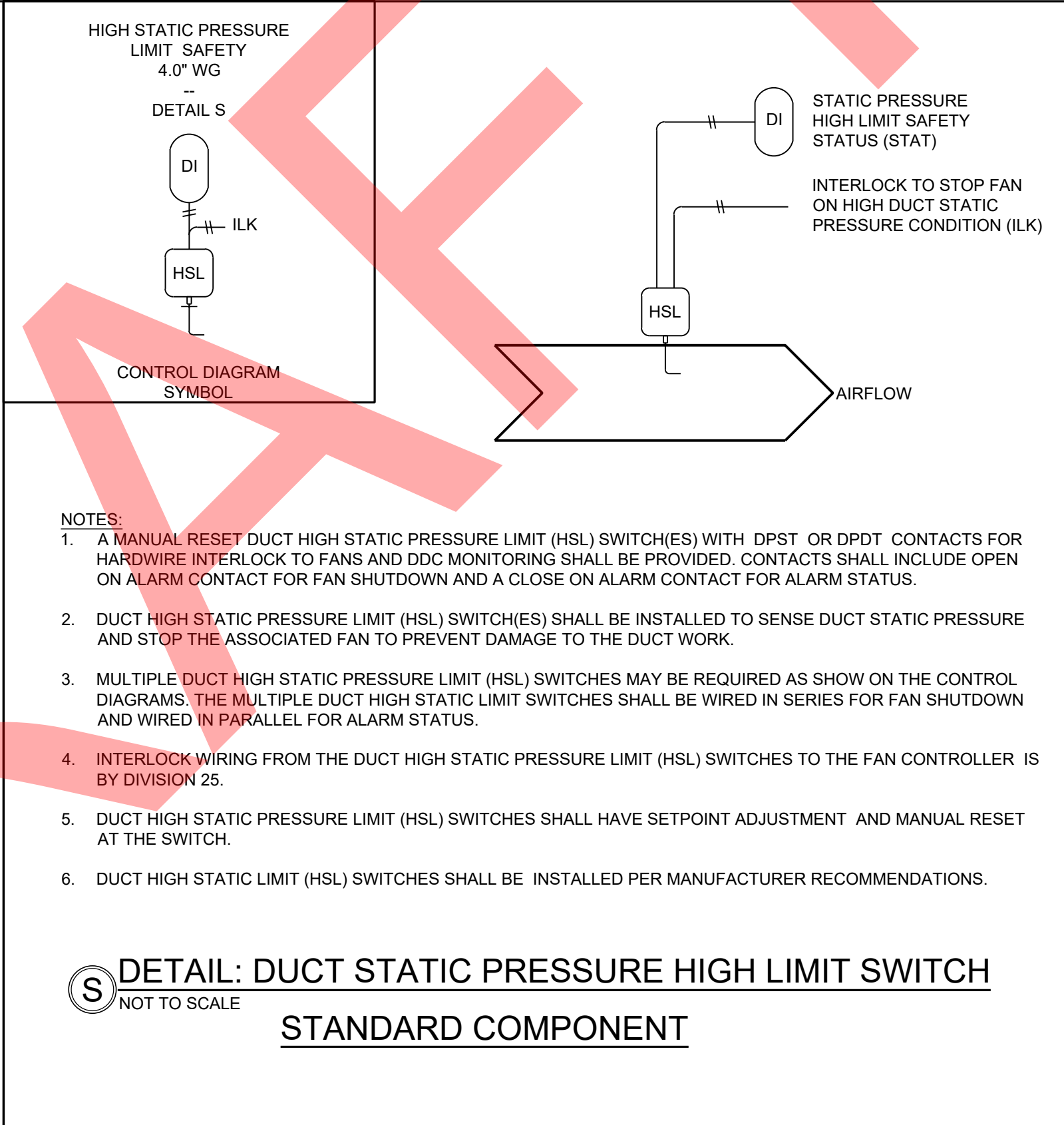
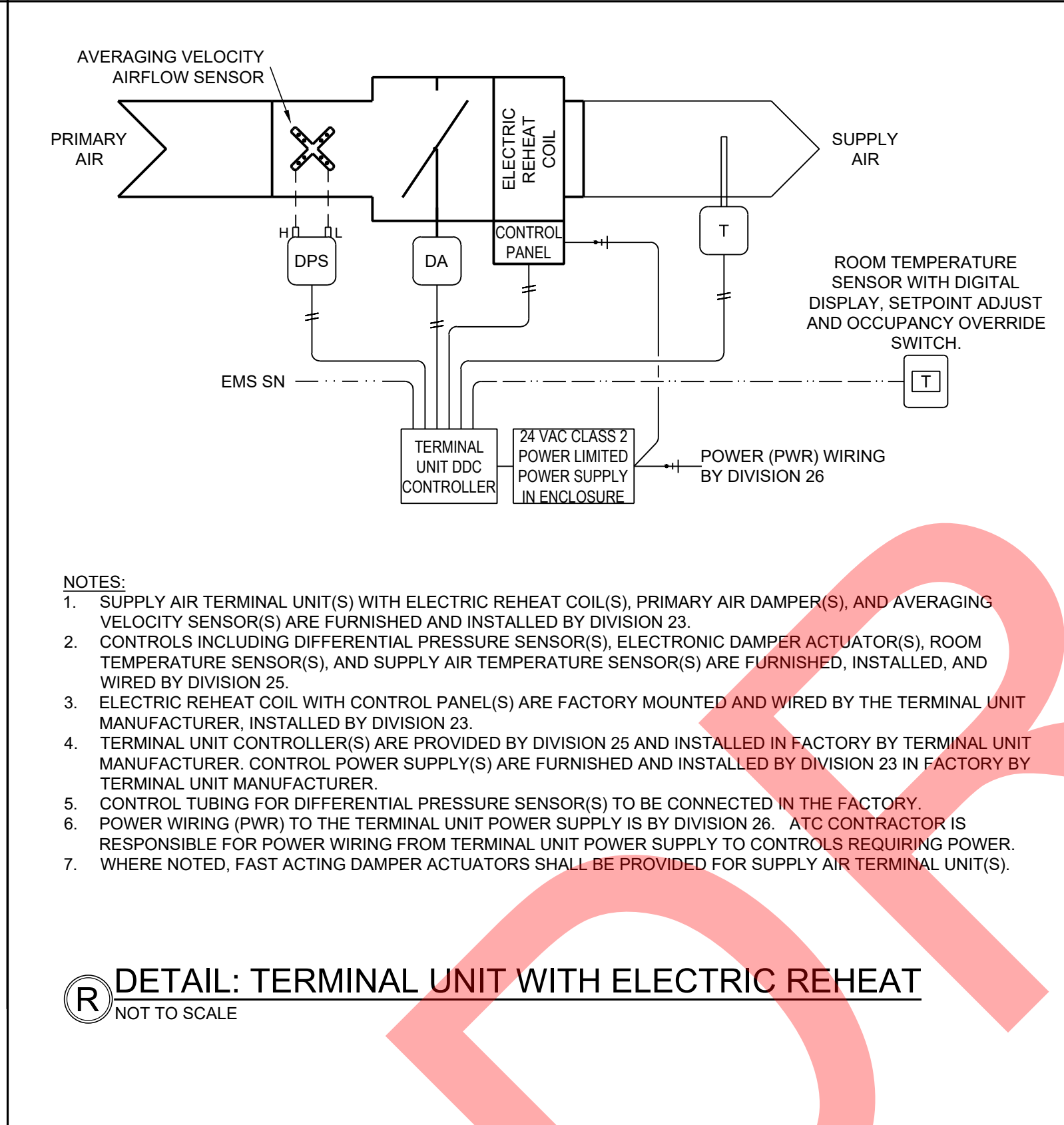
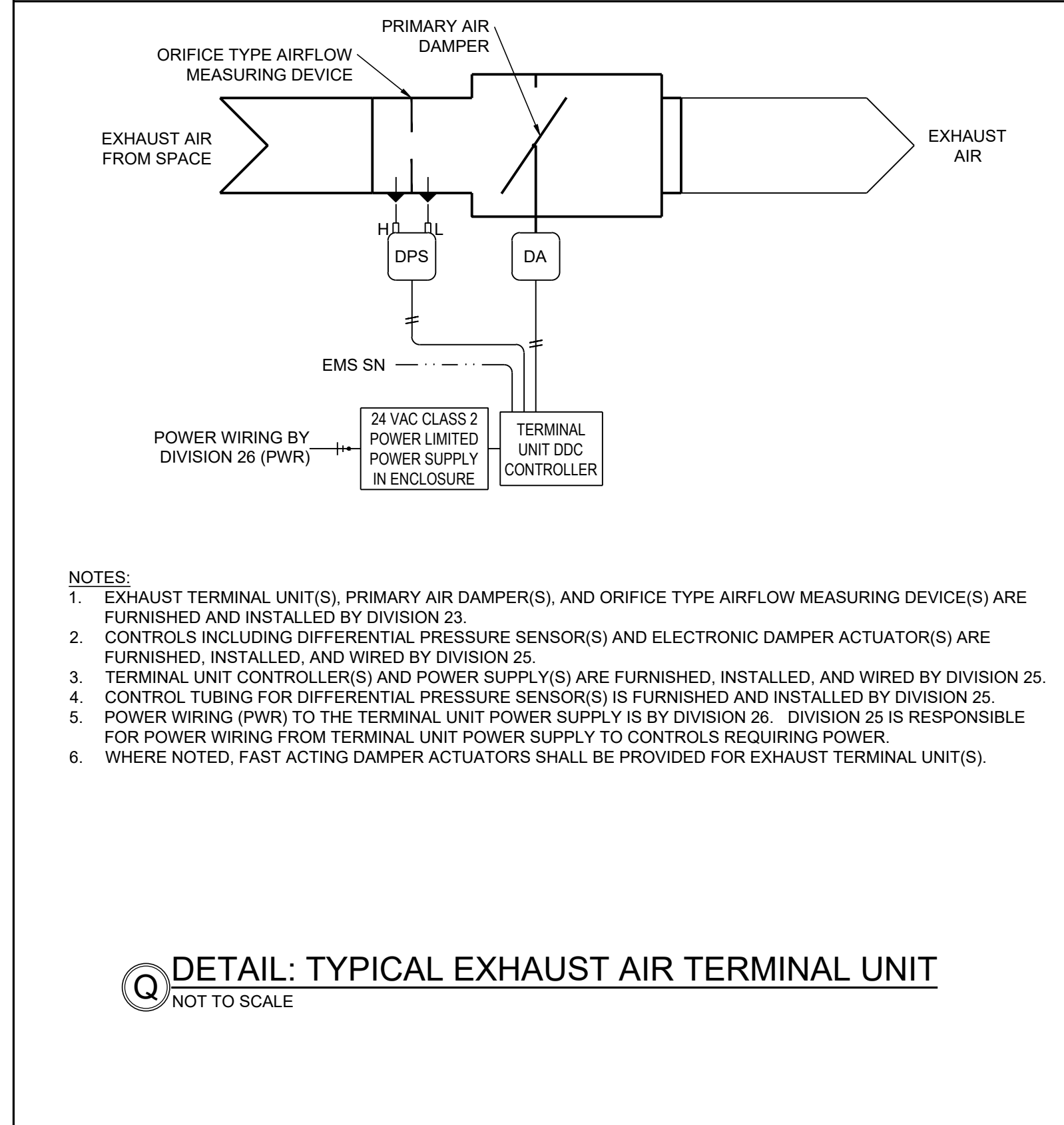
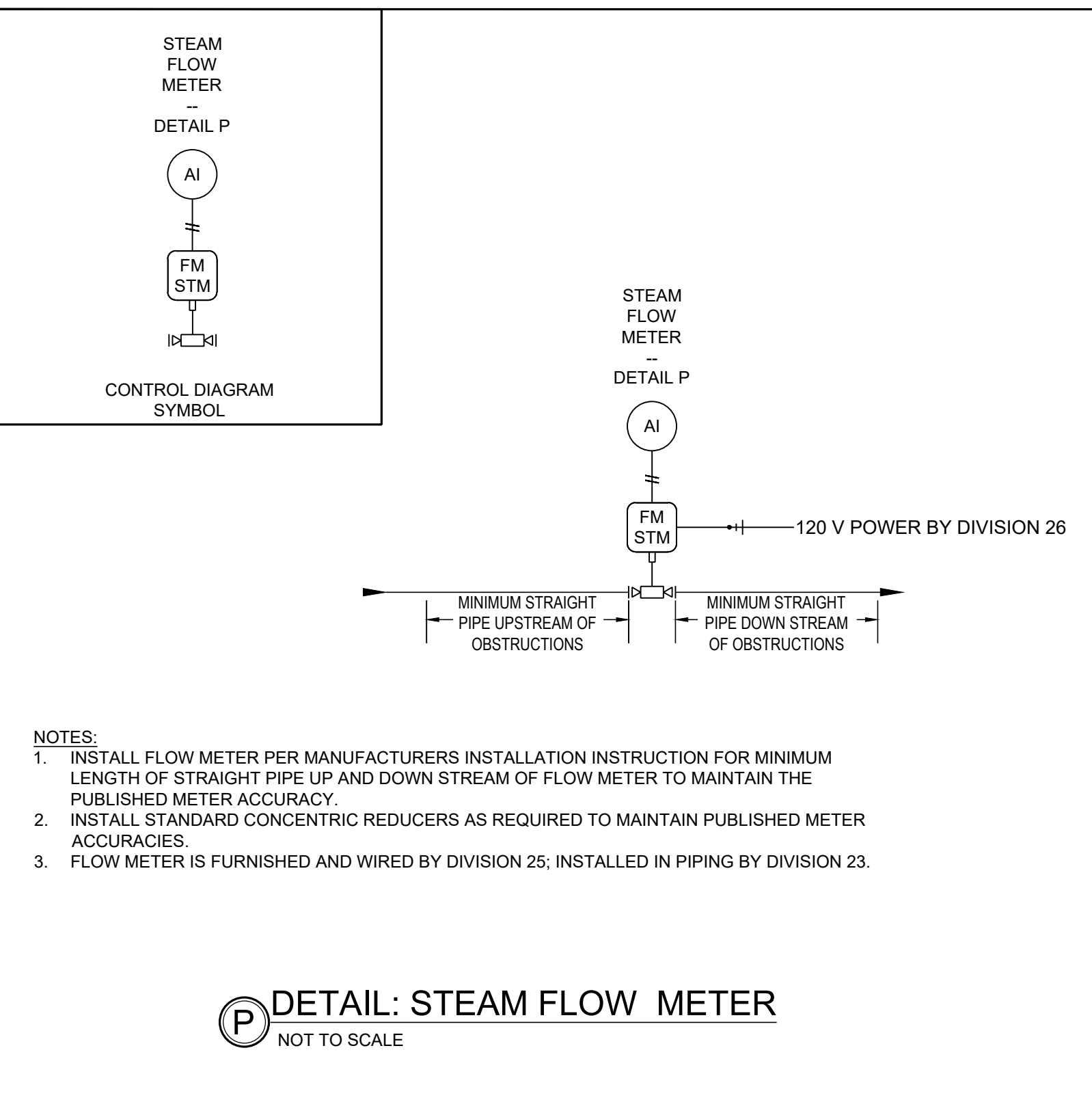
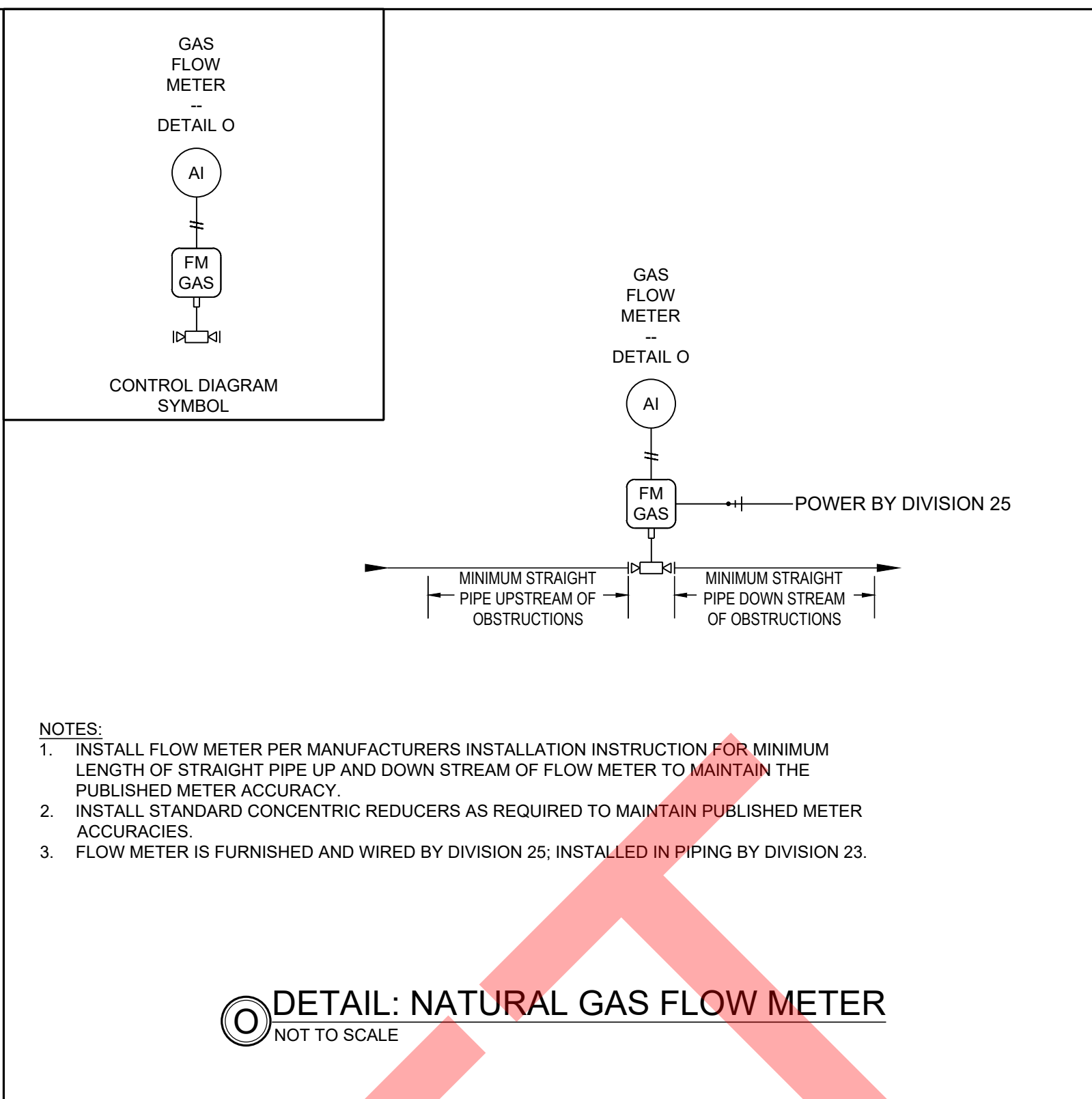
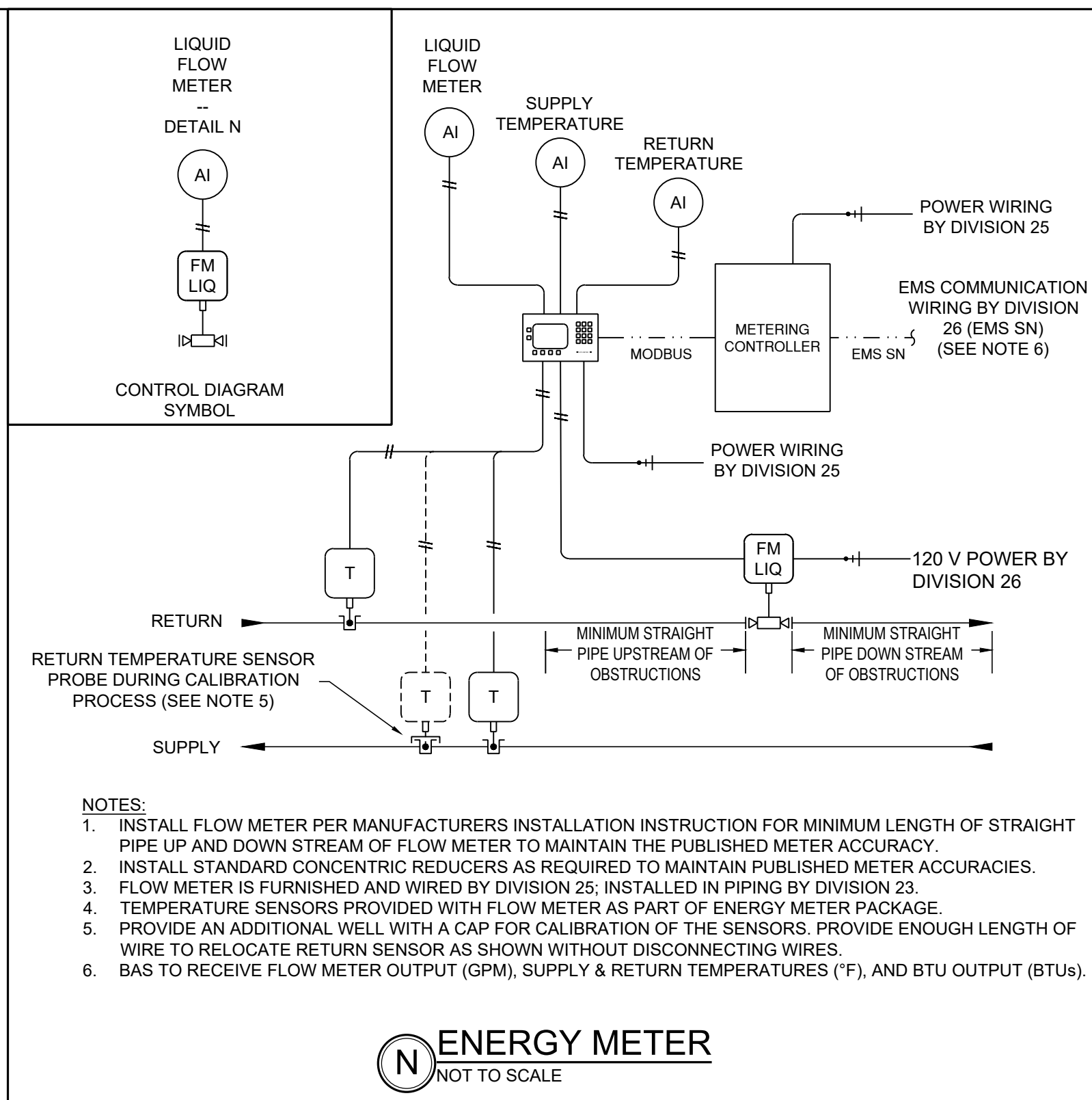
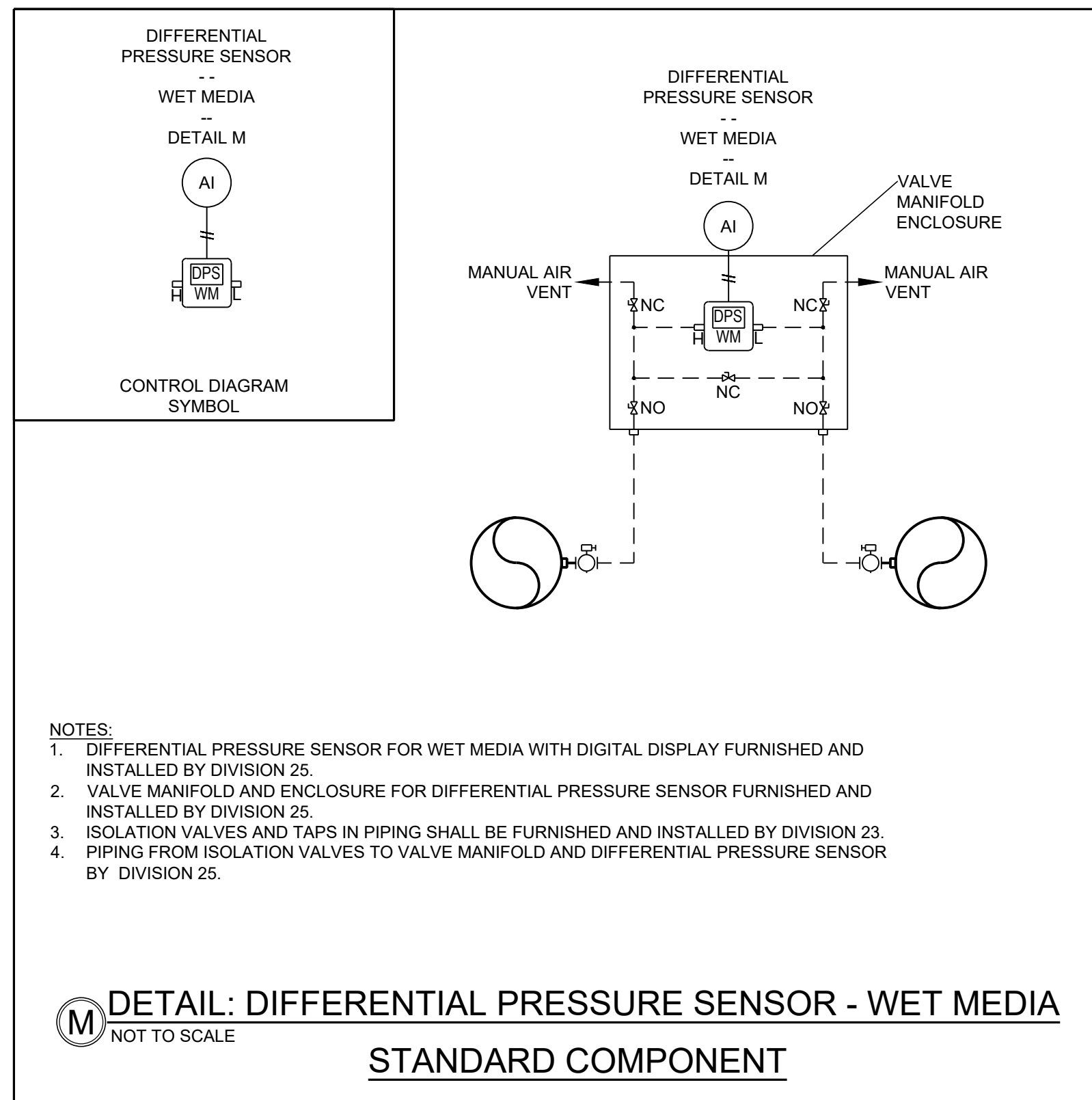

MARK	DATE	DESCRIPTION
ISSUE DATE:	09/17/21	
PROJECT NUMBER:	70-19-0025	
SHEET TITLE: CONTROLS DETAILS 2		
SHEET NUMBER: ATC003		

PRELIMINARY
FOR REVIEW ONLY

ENGINEER SEAL

INITIAL MODERNIZATION SOLUTION
LOUISIANA STATE UNIVERSITY
LOUISIANA ENERGY PARTNERS
BATON ROUGE, LOUISIANA

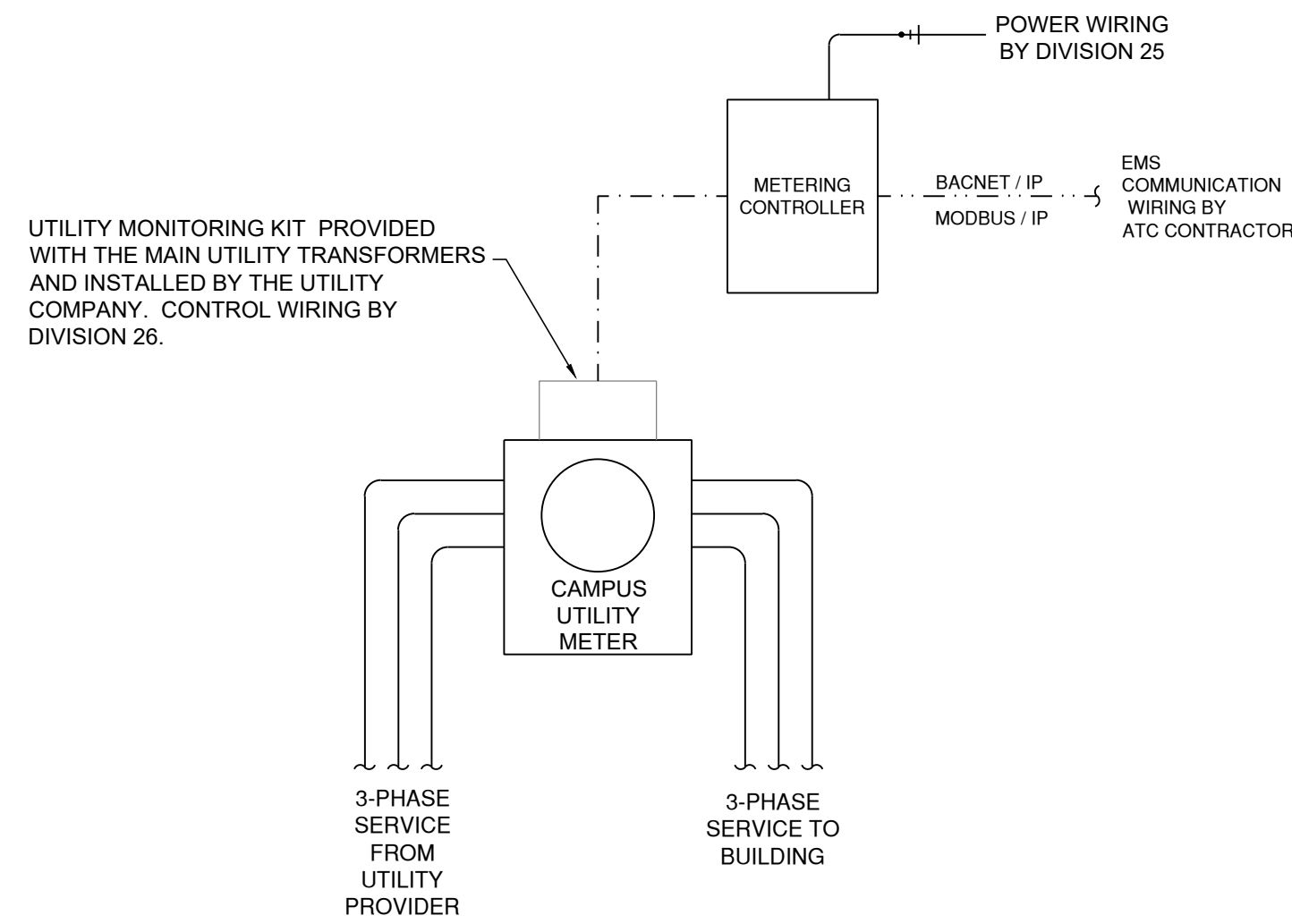

ENERGY MONITORING:
THE BAS SHALL OBTAIN THE BUILDING UTILITY USAGE. THE BAS SHALL LOG AND DISPLAY UTILITY USAGE (KWH). THE BAS TO CALCULATE AND DISPLAY:
A. TOTALIZED ELECTRICITY CONSUMPTION (KWH) = TOTALIZED PULSE COUNT X KWH PER PULSE.
B. 15 MINUTE INTERVAL ELECTRICITY CONSUMPTION (KWH) = DIFFERENCE BETWEEN TOTALIZED ELECTRICITY CONSUMPTION FROM 0:00 TO 0:15, 0:15 TO 0:30, ETC.
C. 15 MINUTE INTERVAL AVERAGE ELECTRICITY DEMAND (KW) = 15 MINUTE INTERVAL ELECTRICITY CONSUMPTION (KWH) X 4

Y CAMPUS ELECTRICAL UTILITY METERING
NOT TO SCALE

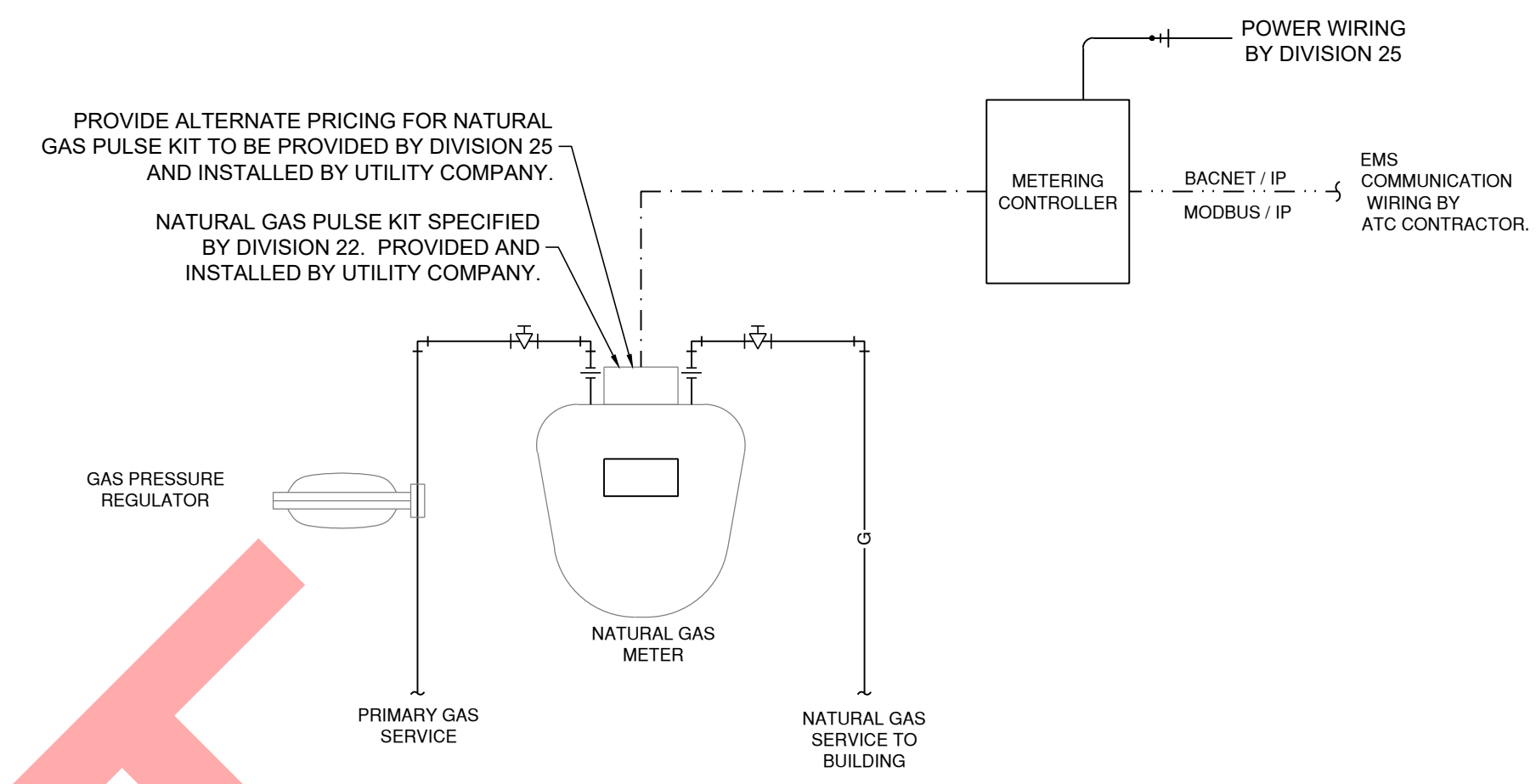

THE EMS IS TO CALCULATE AND DISPLAY ON GRAPHIC, TREND, AND ARCHIVE THE FOLLOWING VIRTUAL POINTS:
A. (FOR METERS WITH PRESSURE CORRECTION DEVICES) TOTALIZED NATURAL GAS CONSUMPTION (CCF) = TOTALIZED PULSE COUNT X CORRECTED CUBIC FEET PER PULSE / 100.
B. (FOR METERS WITHOUT PRESSURE CORRECTION DEVICES) TOTALIZED NATURAL GAS CONSUMPTION (CCF) = TOTALIZED PULSE COUNT X UNCORRECTED CUBIC FEET PER PULSE X PRESSURE CORRECTION FACTOR / 100.
C. 15 MINUTE INTERVAL NATURAL GAS CONSUMPTION (CCF) = DIFFERENCE BETWEEN TOTALIZED NATURAL GAS CONSUMPTION FROM 0:00 TO 0:15, 0:15 TO 0:30, ETC.

Z CAMPUS NATURAL GAS UTILITY METERING
NOT TO SCALE

ENERGY MONITORING:
THE BAS SHALL OBTAIN THE PLANT UTILITY USAGE BY SUMMING POWER USAGE FROM THE HEATING WATER PUMPS, CHILLED WATER PUMPS, CONDENSER WATER PUMPS, EXHAUST FANS, CHILLERS, COOLING TOWERS, EQUIPMENT VFD'S AND STARTERS AND OTHER EQUIPMENT WITH POWER OUTPUT AVAILABLE. THE BAS SHALL LOG AND DISPLAY UTILITY INSTANTANEOUS AND AVERAGE VOLTAGE, CURRENT, POWER (KW), USAGE (KWH), AND POWER FACTOR. THE BAS SHALL DISPLAY INSTANTANEOUS, HOURLY, DAILY, MONTHLY, YEARLY VALUES, ALARMS.
FOR JACK T. STEPHENS SPINE AND NEUROSCIENCE INSTITUTE COOLING TOWERS BASIN HEATERS, WHEN THE BASIN HEATER TREND STATUS = ON, CREATE AND TREND A CALCULATED POINT FOR 16 KW PER BASIN HEATER THAT STATUS = ON. (I.E. IF NO COOLING TOWER BASIN HEATERS ARE ON THEN 0 KW, IF ONE BASIN HEATER = ON THEN 16 KW, AND IF TWO BASIN HEATERS = ON THEN 32 KW)
THE BUILDING USAGE CAN BE CALCULATED AS THE DIFFERENCE BETWEEN THE TOTAL FACILITY USAGE AND THE PLANT USAGE.
REFER TO DASHBOARD GRAPHICS FOR FURTHER UTILITY MONITORING REQUIREMENTS.

AA PLANT ELECTRICAL METERING
NOT TO SCALE

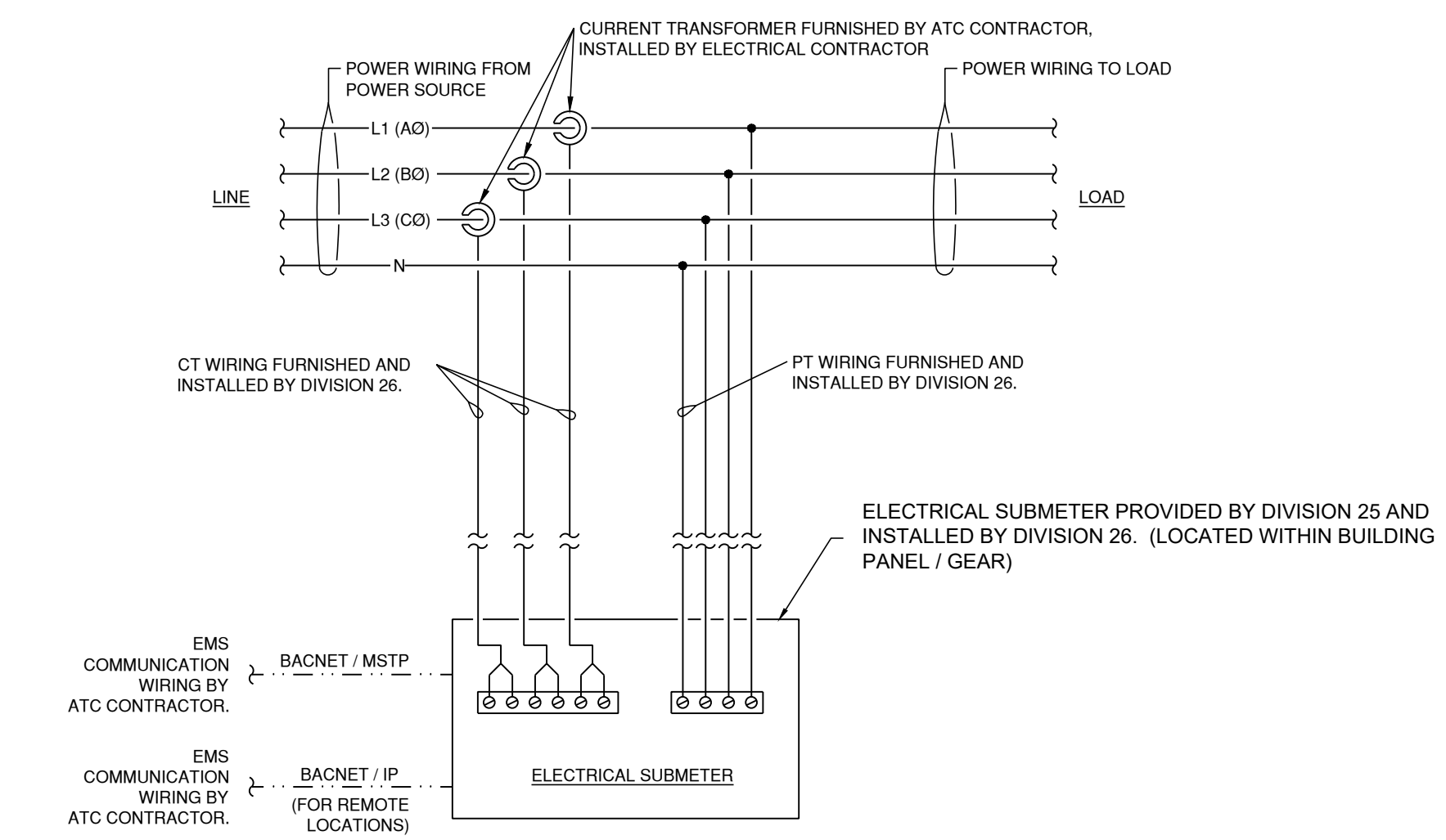

ENERGY MONITORING:
THE BAS SHALL METER BUILDING ZONE UTILITY USAGE. THE BAS SHALL LOG AND DISPLAY UTILITY INSTANTANEOUS AND AVERAGE VOLTAGE, CURRENT, POWER (KW), USAGE (KWH), AND POWER FACTOR. THE BAS SHALL DISPLAY INSTANTANEOUS, HOURLY, DAILY, MONTHLY, YEARLY VALUES, ALARMS, AND PROVIDE COMPARATIVE DATA FROM PREVIOUS HOUR, DAY, MONTH, AND YEARS ON A DASH BOARD GRAPHIC IN THE BAS. METERS TO BE SIZED BY ELECTRICAL, REFER TO DRAWINGS FOR SIZING.

AB TYPICAL ZONE ELECTRICAL METER
SCALE: NONE

MARK	DATE	DESCRIPTION
ISSUE DATE:	09/17/21	
PROJECT NUMBER:	70-19-0025	
SHEET TITLE: CONTROLS DETAILS 3		
SHEET NUMBER: ATC004		

PRELIMINARY
FOR REVIEW ONLY

ENGINEER SEAL

INITIAL MODERNIZATION SOLUTION
LOUISIANA STATE UNIVERSITY
LOUISIANA ENERGY PARTNERS
BATON ROUGE, LOUISIANA

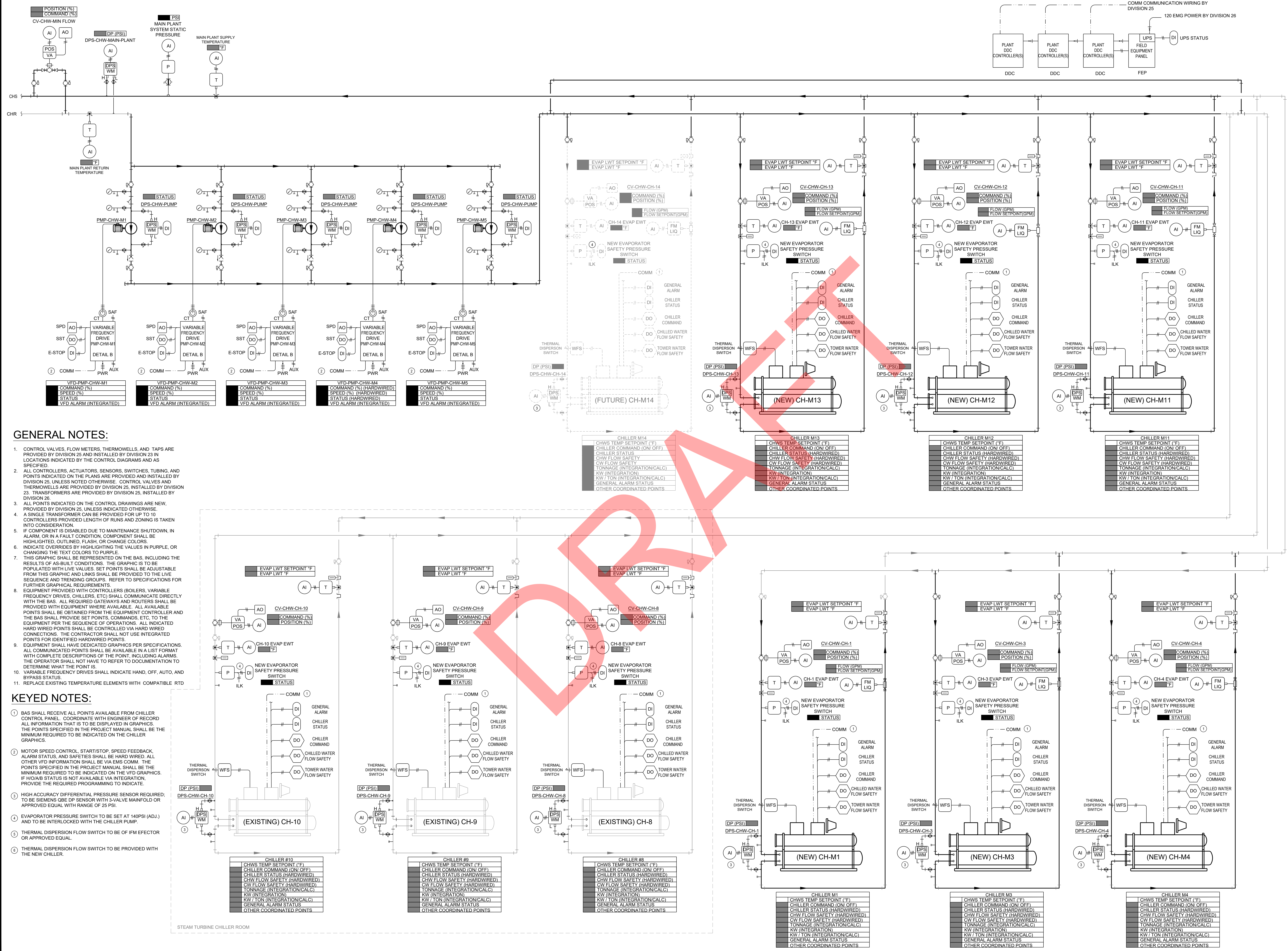

GENERAL NOTES:

- CONTROL VALVES, FLOW METERS, THERMOWELLS, AND TAPS ARE PROVIDED BY DIVISION 25 AND INSTALLED BY DIVISION 23 IN LOCATIONS INDICATED BY THE CONTROL DIAGRAMS AND AS SPECIFIED.
- ALL CONTROLLERS, ACTUATORS, SENSORS, SWITCHES, TUBING, AND POINTS INDICATED ON THE PLANS ARE PROVIDED AND INSTALLED BY DIVISION 25, UNLESS NOTED OTHERWISE. CONTROL VALVES AND THERMOWELLS ARE PROVIDED BY DIVISION 25, INSTALLED BY DIVISION 23. TRANSFORMERS ARE PROVIDED BY DIVISION 25, INSTALLED BY DIVISION 26.
- ALL POINTS INDICATED ON THE CONTROL DRAWINGS ARE NEW, PROVIDED BY DIVISION 25, UNLESS INDICATED OTHERWISE.
- A SINGLE TRANSFORMER CAN BE PROVIDED FOR UP TO 10 CONTROLLERS PROVIDED LENGTH OF RUNS AND ZONING IS TAKEN INTO CONSIDERATION.
- IF COMPONENT IS DISABLED DUE TO MAINTENANCE SHUTDOWN, IN ALARM, OR IN A FAULT CONDITION, COMPONENT SHALL BE HIGHLIGHTED, OUTLINED, FLASH, OR CHANGE COLORS.
- INDICATE OVERRIDES BY HIGHLIGHTING THE VALUES IN PURPLE, OR CHANGING THE TEXT COLORS TO PURPLE.
- THIS GRAPHIC SHALL BE REPRESENTED ON THE BAS, INCLUDING THE RESULTS OF AS-BUILT CONDITIONS. THE GRAPHIC IS TO BE POPULATED WITH LIVE VALUES. SET POINTS SHALL BE ADJUSTABLE FROM THIS GRAPHIC AND LINKS SHALL BE PROVIDED TO THE LIVE SEQUENCE AND TRENDED GROUPS. REFER TO SPECIFICATIONS FOR FURTHER GRAPHICAL REQUIREMENTS.
- EQUIPMENT PROVIDED WITH CONTROLLERS (BOILERS, VARIABLE FREQUENCY DRIVES, CHILLERS, ETC) SHALL COMMUNICATE DIRECTLY WITH THE BAS. ALL REQUIRED GATEWAYS AND ROUTERS SHALL BE PROVIDED WITH EQUIPMENT WHERE AVAILABLE. ALL AVAILABLE POINTS SHALL BE OBTAINED FROM THE EQUIPMENT CONTROLLER AND THE BAS SHALL PROVIDE SET POINTS, COMMANDS, ETC. TO THE EQUIPMENT PER THE SEQUENCE OF OPERATIONS. ALL INDICATED HARD WIRED POINTS SHALL BE CONTROLLED VIA HARD WIRED CONNECTIONS. THE CONTRACTOR SHALL NOT USE INTEGRATED POINTS FOR IDENTIFIED HARDWIRED POINTS.
- EQUIPMENT SHALL HAVE DEDICATED GRAPHICS PER SPECIFICATIONS. ALL COMMUNICATED POINTS SHALL BE AVAILABLE IN A LIST FORMAT WITH COMPLETE DESCRIPTIONS OF THE POINT, INCLUDING ALARMS. THE OPERATOR SHALL NOT HAVE TO REFER TO DOCUMENTATION TO DETERMINE WHAT THE POINT IS.
- VARIABLE FREQUENCY DRIVES SHALL INDICATE HAND, OFF, AUTO, AND BYPASS STATUS.
- REPLACE EXISTING TEMPERATURE ELEMENTS WITH COMPATIBLE RTD

KEYED NOTES:

- BAS SHALL RECEIVE ALL POINTS AVAILABLE FROM CHILLER CONTROL PANEL. COORDINATE WITH ENGINEER OF RECORD ALL INFORMATION THAT IS TO BE DISPLAYED IN GRAPHICS. THE POINTS SPECIFIED IN THE PROJECT MANUAL SHALL BE THE MINIMUM REQUIRED TO BE INDICATED ON THE CHILLER GRAPHICS.
- MOTOR SPEED CONTROL, START/STOP, SPEED FEEDBACK, ALARM STATUS, AND SAFETIES SHALL BE HARD WIRED. ALL OTHER VFD INFORMATION SHALL BE VIA EMS COMM. THE POINTS SPECIFIED IN THE PROJECT MANUAL SHALL BE THE MINIMUM REQUIRED TO BE INDICATED ON THE GRAPHICS. IF HIC/A/B STATUS IS NOT AVAILABLE VIA INTEGRATION, PROVIDE THE REQUIRED PROGRAMMING TO INDICATE.
- HIGH ACCURACY DIFFERENTIAL PRESSURE SENSOR REQUIRED; TO BE SIEMENS QBE DP SENSOR WITH 3-VALVE MAINFOLD OR APPROVED EQUAL WITH RANGE OF 25 PSI.
- EVAPORATOR PRESSURE SWITCH TO BE SET AT 140PSI (ADJ.) AND TO BE INTERLOCKED WITH THE CHILLER PUMP.
- THERMAL DISPERSION FLOW SWITCH TO BE OF IFM EFFECTOR OR APPROVED EQUAL.
- THERMAL DISPERSION FLOW SWITCH TO BE PROVIDED WITH THE NEW CHILLER.

1 MAIN CHILLED WATER PLANT CONTROL DIAGRAM
NOT TO SCALE

MARK	DATE	DESCRIPTION
ISSUE DATE:	09/17/21	
PROJECT NUMBER:	70-19-0025	
SHEET TITLE: MAIN PLANT CHILLED WATER CONTROL DIAGRAM		
SHEET NUMBER: ATC100		

PRELIMINARY
FOR REVIEW ONLY

ENGINEER SEAL

**INITIAL MODERNIZATION SOLUTION
LOUISIANA STATE UNIVERSITY
LOUISIANA ENERGY PARTNERS
BATON ROUGE, LOUISIANA**

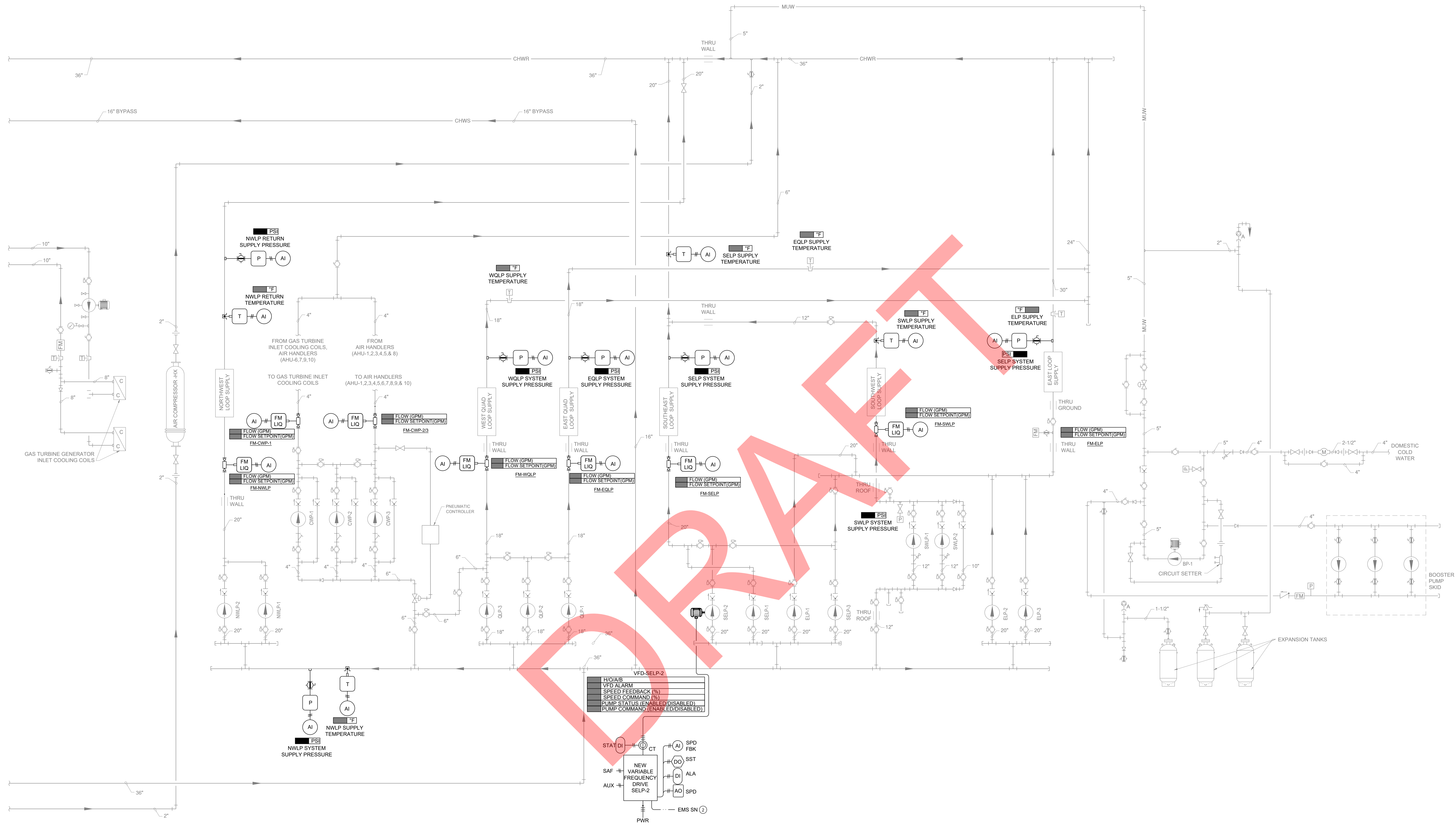

1 CAMPUS DISTRIBUTION - CHILLED WATER PIPING CONTROL DIAGRAM

MARK	DATE	DESCRIPTION
ISSUE DATE:	09/17/21	
PROJECT NUMBER:	70-19-0025	
SHEET TITLE:		
CAMPUS CHILLED WATER DISTRIBUTION CONTROL DIAGRAM		
SHEET NUMBER:		
ATC103		

PRELIMINARY FOR REVIEW ONLY

ENGINEER SEAL

INITIAL MODERNIZATION SOLUTION
LOUISIANA STATE UNIVERSITY
LOUISIANA ENERGY PARTNERS
 BATON ROUGE, LOUISIANA

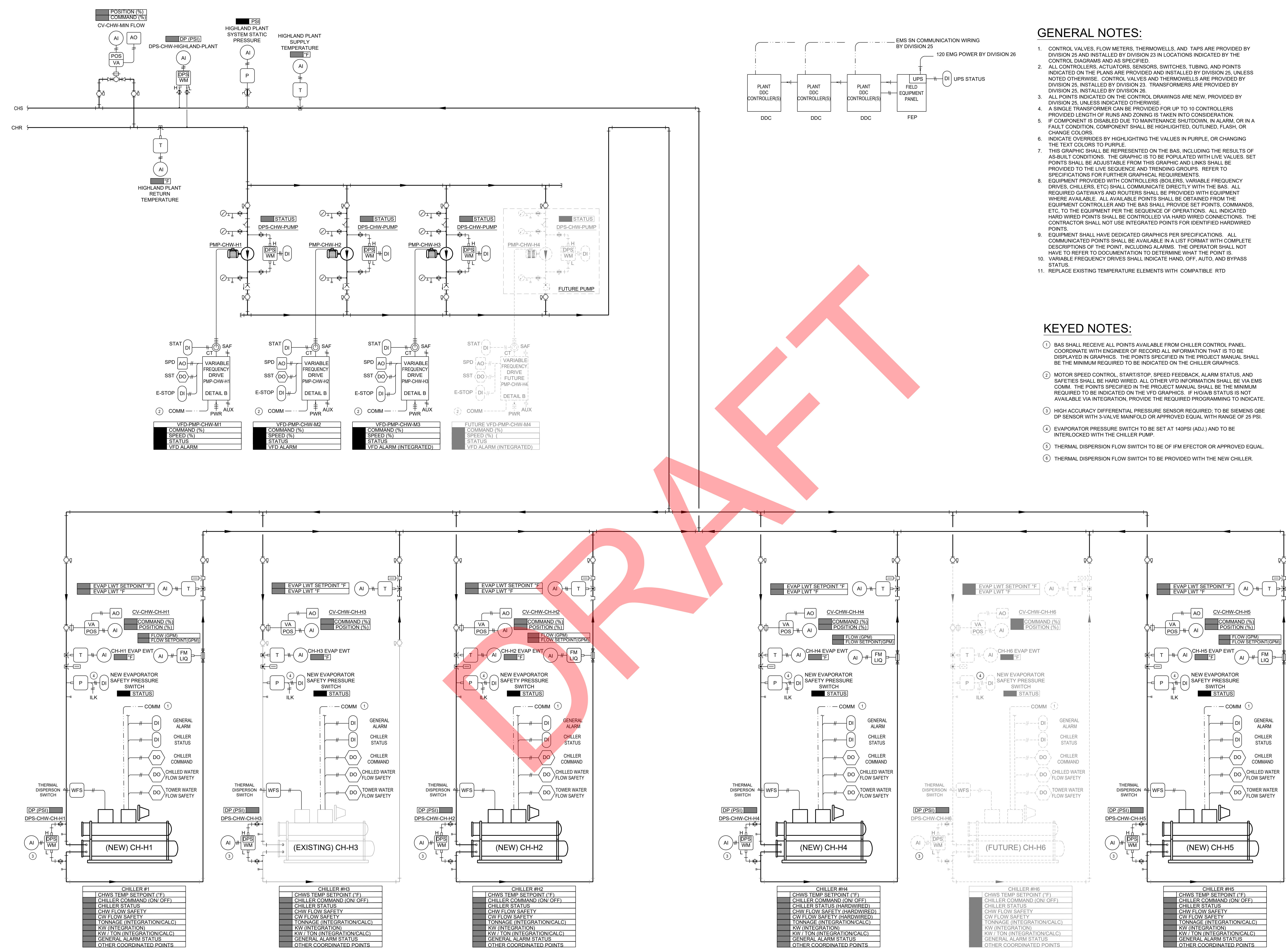

- GENERAL NOTES:**
- CONTROL VALVES, FLOW METERS, THERMOWELLS, AND TAPS ARE PROVIDED BY DIVISION 25 AND INSTALLED BY DIVISION 23 IN LOCATIONS INDICATED BY THE CONTROL DIAGRAMS AND AS SPECIFIED.
 - ALL CONTROLLERS, ACTUATORS, SENSORS, SWITCHES, TUBING, AND POINTS INDICATED ON THE PLANS ARE PROVIDED AND INSTALLED BY DIVISION 25, UNLESS NOTED OTHERWISE. CONTROL VALVES AND THERMOWELLS ARE PROVIDED BY DIVISION 25, INSTALLED BY DIVISION 23. TRANSFORMERS ARE PROVIDED BY DIVISION 25, INSTALLED BY DIVISION 26.
 - ALL POINTS INDICATED ON THE CONTROL DRAWINGS ARE NEW, PROVIDED BY DIVISION 25, UNLESS INDICATED OTHERWISE.
 - A SINGLE TRANSFORMER CAN BE PROVIDED FOR UP TO 10 CONTROLLERS PROVIDED LENGTH OF RUNS AND ZONING IS TAKEN INTO CONSIDERATION.
 - IF COMPONENT IS DISABLED DUE TO MAINTENANCE SHUTDOWN, IN ALARM, OR IN A FAULT CONDITION, COMPONENT SHALL BE HIGHLIGHTED, OUTLINED, FLASH, OR CHANGE COLORS.
 - INDICATE OVERRIDES BY HIGHLIGHTING THE VALUES IN PURPLE, OR CHANGING THE TEXT COLORS TO PURPLE.
 - THIS GRAPHIC SHALL BE REPRESENTED ON THE BAS, INCLUDING THE RESULTS OF AS-BUILT CONDITIONS. THE GRAPHIC IS TO BE POPULATED WITH LIVE VALUES. SET POINTS SHALL BE ADJUSTABLE FROM THIS GRAPHIC AND LINKS SHALL BE PROVIDED TO THE LIVE SEQUENCE AND TRENDING GROUPS. REFER TO SPECIFICATIONS FOR FURTHER GRAPHICAL REQUIREMENTS.
 - EQUIPMENT PROVIDED WITH CONTROLLERS (BOILERS, VARIABLE FREQUENCY DRIVES, CHILLERS, ETC) SHALL COMMUNICATE DIRECTLY WITH THE BAS. ALL REQUIRED GATEWAYS AND ROUTERS SHALL BE PROVIDED WITH EQUIPMENT WHERE AVAILABLE. ALL AVAILABLE POINTS SHALL BE OBTAINED FROM THE EQUIPMENT CONTROLLER AND THE BAS SHALL PROVIDE SET POINTS, COMMANDS, ETC. TO THE EQUIPMENT PER THE SEQUENCE OF OPERATIONS. ALL INDICATED HARD WIRED POINTS SHALL BE CONTROLLED VIA HARD WIRED CONNECTIONS. THE CONTRACTOR SHALL NOT USE INTEGRATED POINTS FOR IDENTIFIED HARDWIRED POINTS.
 - EQUIPMENT SHALL HAVE DEDICATED GRAPHICS PER SPECIFICATIONS. ALL COMMUNICATED POINTS SHALL BE AVAILABLE IN A LIST FORMAT WITH COMPLETE DESCRIPTIONS OF THE POINT, INCLUDING ALARMS. THE OPERATOR SHALL NOT HAVE TO REFER TO DOCUMENTATION TO DETERMINE WHAT THE POINT IS.
 - VARIABLE FREQUENCY DRIVES SHALL INDICATE HAND, AUTO, AND BYPASS STATUS.
 - REPLACE EXISTING TEMPERATURE ELEMENTS WITH COMPATIBLE RTD

- KEYED NOTES:**
- BAS SHALL RECEIVE ALL POINTS AVAILABLE FROM CHILLER CONTROL PANEL. COORDINATE WITH ENGINEER OF RECORD AS TO WHAT IS TO BE DISPLAYED IN GRAPHICS. THE POINTS SPECIFIED IN THE PROJECT MANUAL SHALL BE THE MINIMUM REQUIRED TO BE INDICATED ON THE CHILLER GRAPHICS.
 - MOTOR SPEED CONTROL, START/STOP, SPEED FEEDBACK, ALARM STATUS, AND SAFETIES SHALL BE HARD WIRED. ALL OTHER VFD INFORMATION SHALL BE VIA EMS COMM. THE POINTS SPECIFIED IN THE PROJECT MANUAL SHALL BE THE MINIMUM REQUIRED TO BE INDICATED ON THE VFD GRAPHICS. IF HQ/AB STATUS IS NOT AVAILABLE VIA INTEGRATION, PROVIDE THE REQUIRED PROGRAMMING TO INDICATE.
 - HIGH ACCURACY DIFFERENTIAL PRESSURE SENSOR REQUIRED; TO BE SIEMENS OBE DP SENSOR WITH 3-VALVE MAINFOLD OR APPROVED EQUAL WITH RANGE OF 25 PSI.
 - EVAPORATOR PRESSURE SWITCH TO BE SET AT 140PSI (ADJ.) AND TO BE INTERLOCKED WITH THE CHILLER PUMP.
 - THERMAL DISPERSION FLOW SWITCH TO BE OF IFM EFFECTOR OR APPROVED EQUAL.
 - THERMAL DISPERSION FLOW SWITCH TO BE PROVIDED WITH THE NEW CHILLER.

1 HIGHLAND CHILLED WATER PLANT CONTROL DIAGRAM
NOT TO SCALE

MARK	DATE	DESCRIPTION
ISSUE DATE:	09/17/21	
PROJECT NUMBER:	70-19-0025	
SHEET TITLE: HIGHLAND PLANT CHILLED WATER CONTROL DIAGRAM		
SHEET NUMBER: ATC106		

PRELIMINARY FOR REVIEW ONLY

ENGINEER SEAL

INITIAL MODERNIZATION SOLUTION
LOUISIANA STATE UNIVERSITY
LOUISIANA ENERGY PARTNERS
BATON ROUGE, LOUISIANA

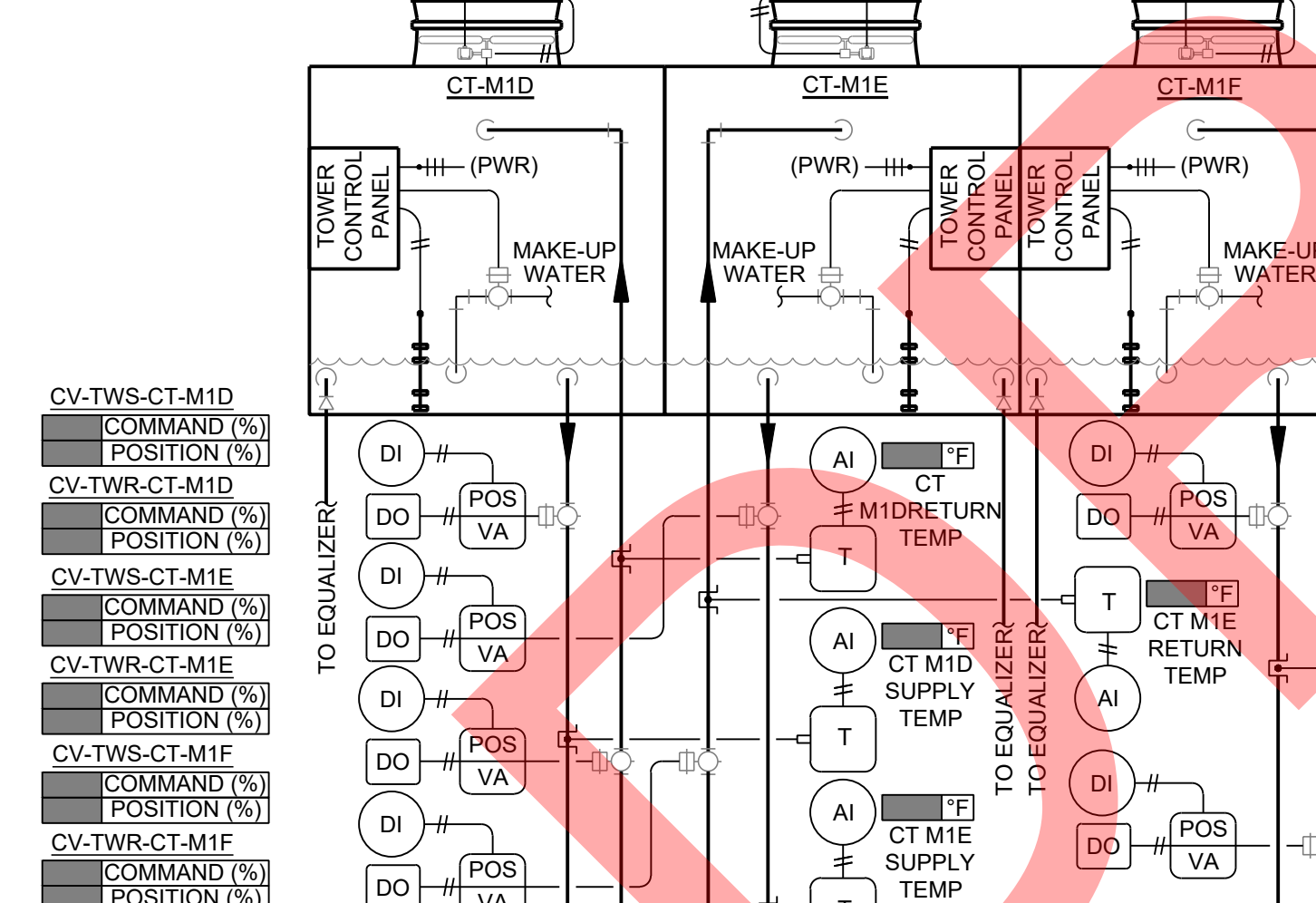
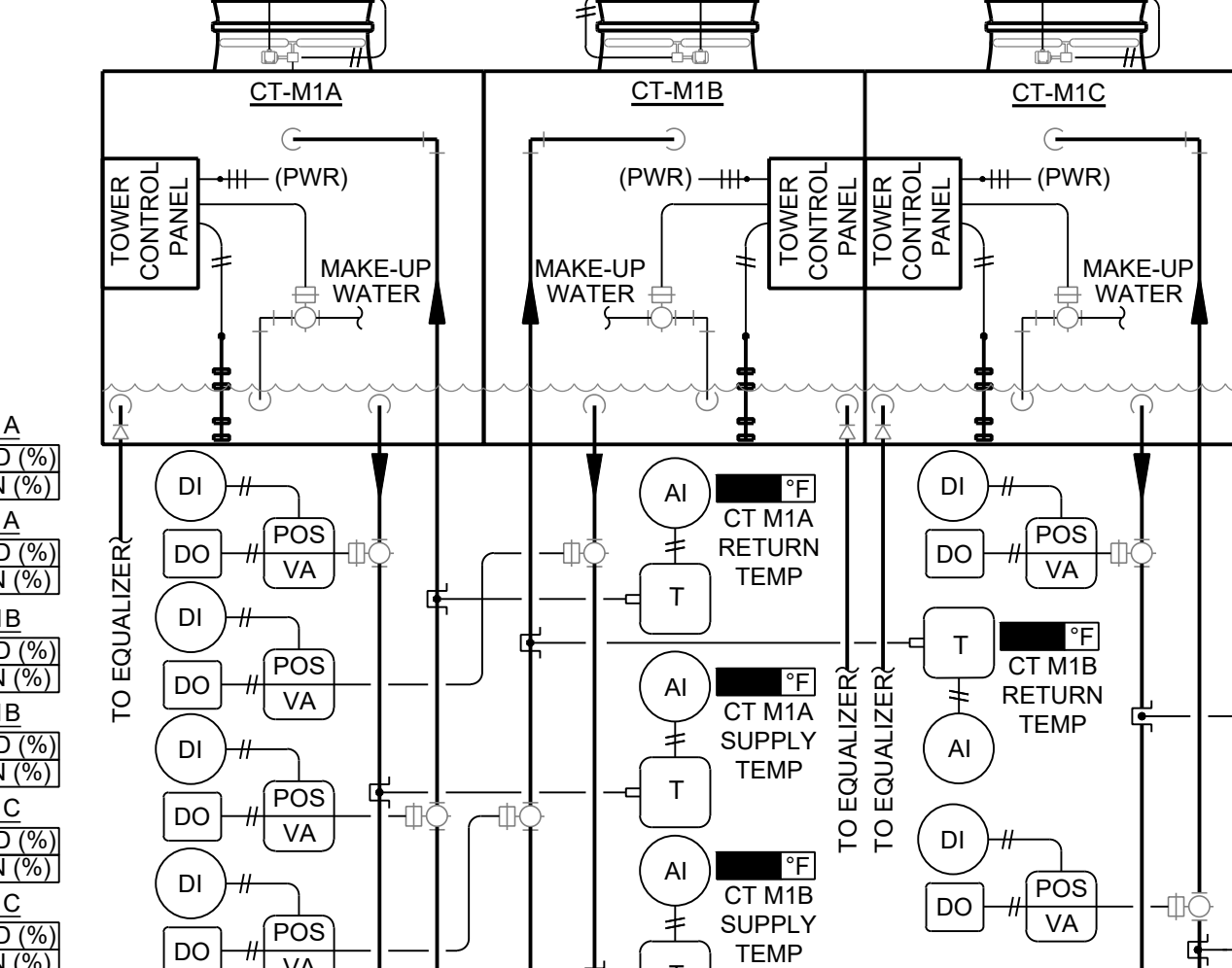
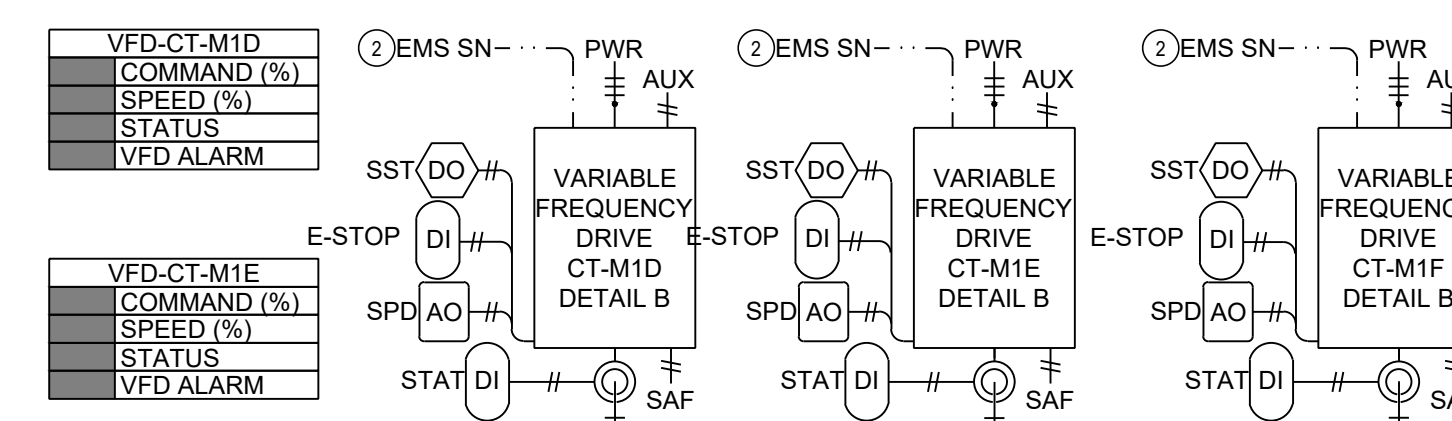
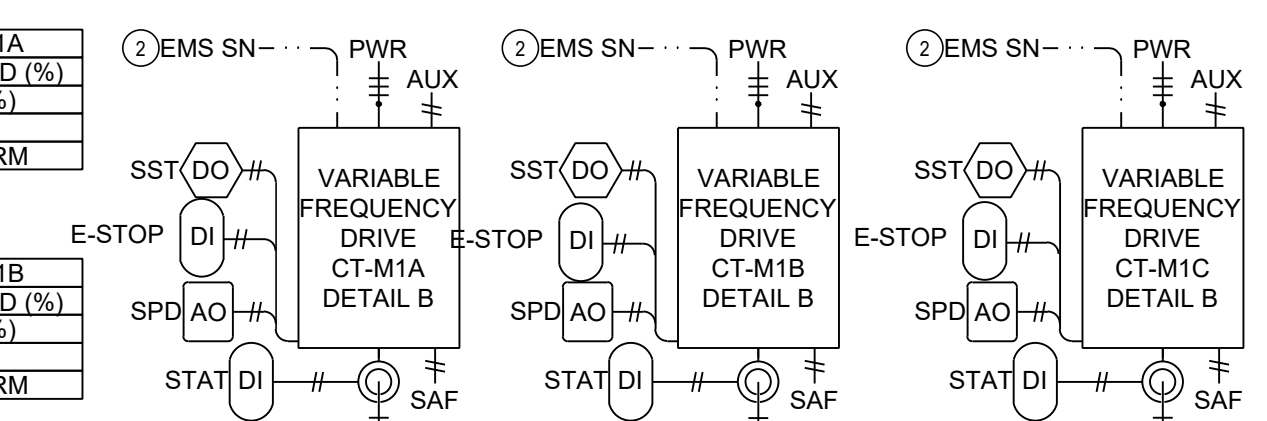
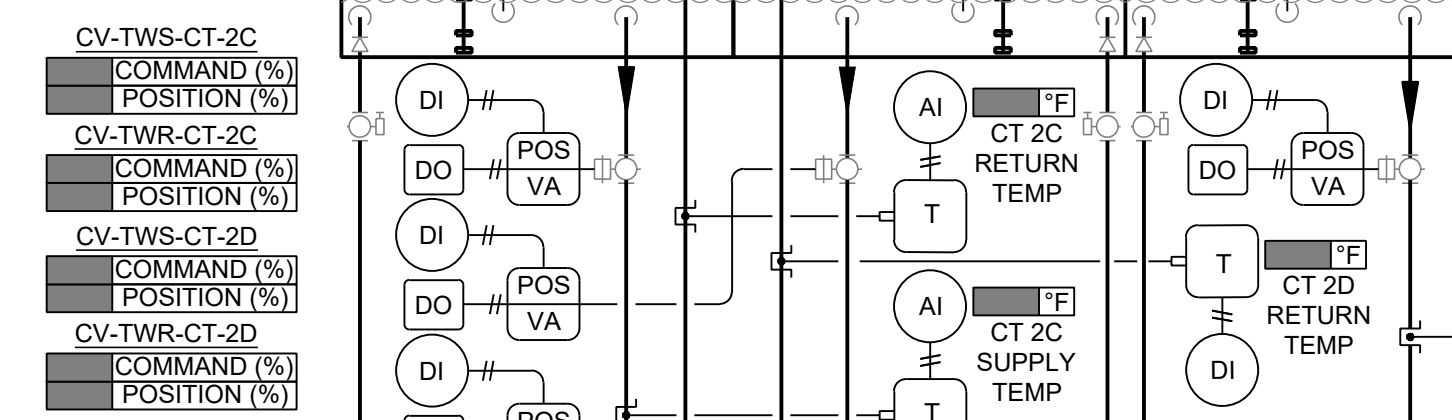
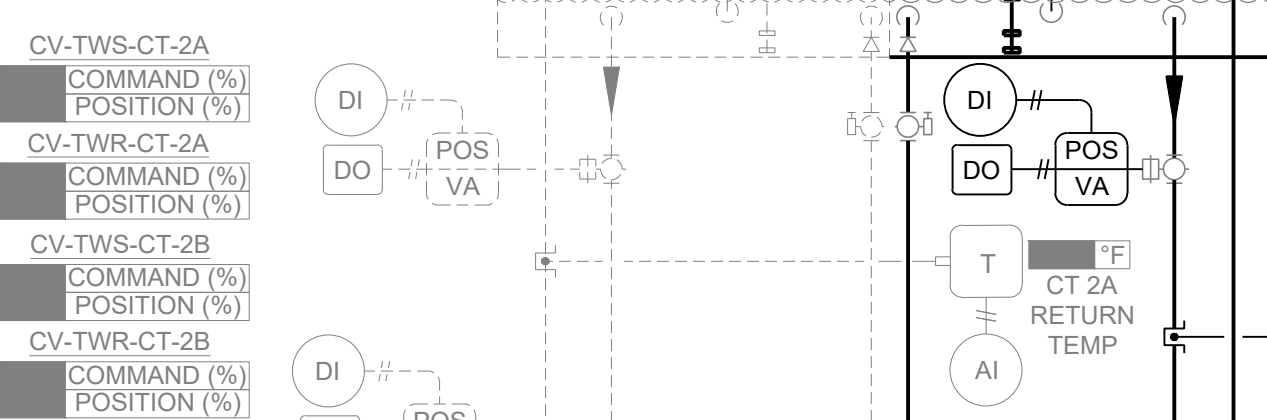
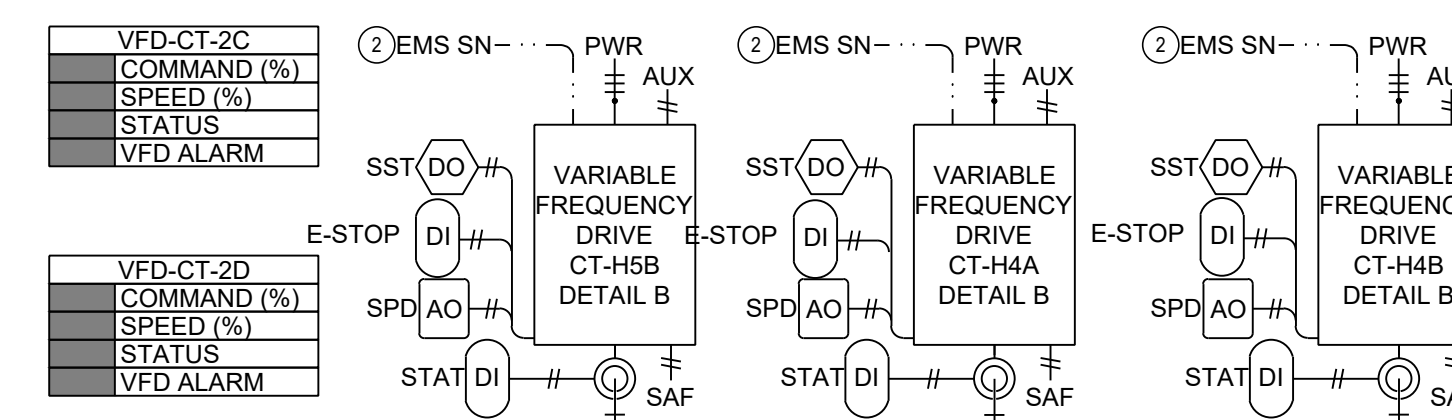
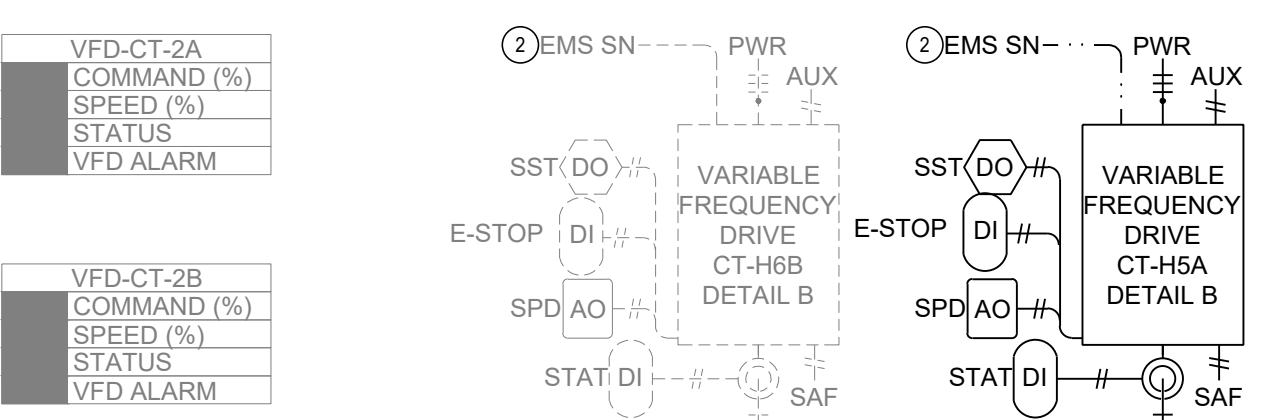

GENERAL NOTES:

- CONTROL VALVES, FLOW METERS, THERMOWELLS, AND TAPS ARE PROVIDED BY DIVISION 25 AND INSTALLED BY DIVISION 23 IN LOCATIONS INDICATED BY THE CONTROL DIAGRAMS AND AS SPECIFIED.
- ALL CONTROLLERS, ACTUATORS, SENSORS, SWITCHES, TUBING, AND POINTS INDICATED ON THE PLANS ARE PROVIDED AND INSTALLED BY DIVISION 25, UNLESS NOTED OTHERWISE. CONTROL VALVES AND THERMOWELLS ARE PROVIDED BY DIVISION 25, INSTALLED BY DIVISION 23. TRANSFORMERS ARE PROVIDED BY DIVISION 25, INSTALLED BY DIVISION 26.
- ALL POINTS INDICATED ON THE CONTROL DRAWINGS ARE NEW, PROVIDED BY DIVISION 25, UNLESS INDICATED OTHERWISE.
- A SINGLE TRANSFORMER CAN BE PROVIDED FOR UP TO 10 CONTROLLERS PROVIDED LENGTH OF RUNS AND ZONING IS TAKEN INTO CONSIDERATION.
- IF COMPONENT IS DISABLED DUE TO MAINTENANCE SHUTDOWN, IN ALARM, OR IN A FAULT CONDITION, COMPONENT SHALL BE HIGHLIGHTED, OUTLINED, FLASH, OR CHANGE COLORS.
- INDICATE OVERRIDES BY HIGHLIGHTING THE VALUES IN PURPLE, OR CHANGING THE TEXT COLORS TO PURPLE.
- THIS GRAPHIC SHALL BE REPRESENTED ON THE BAS, INCLUDING THE RESULTS OF AS-BUILT CONDITIONS. THE GRAPHIC IS TO BE POPULATED WITH LIVE VALUES. SET POINTS SHALL BE ADJUSTABLE FROM THIS GRAPHIC AND LINKS SHALL BE PROVIDED TO THE LIVE SEQUENCE AND TRENDS GROUPS. REFER TO SPECIFICATIONS FOR FURTHER GRAPHICAL REQUIREMENTS.
- EQUIPMENT PROVIDED WITH CONTROLLERS (BOILERS, VARIABLE FREQUENCY DRIVES, CHILLERS, ETC) SHALL COMMUNICATE DIRECTLY WITH THE BAS. ALL REQUIRED GATEWAYS AND ROUTERS SHALL BE PROVIDED WITH EQUIPMENT WHERE AVAILABLE. ALL AVAILABLE POINTS SHALL BE OBTAINED FROM THE EQUIPMENT CONTROLLER AND THE BAS SHALL PROVIDE SET POINTS, COMMANDS, ETC. TO THE EQUIPMENT PER THE SEQUENCE OF OPERATIONS. ALL INDICATED HARD WIRED POINTS SHALL BE CONTROLLED VIA HARD WIRED CONNECTIONS. THE CONTRACTOR SHALL NOT USE INTEGRATED POINTS FOR IDENTIFIED HARDWIRED POINTS.
- EQUIPMENT SHALL HAVE DEDICATED GRAPHICS PER SPECIFICATIONS. ALL COMMUNICATED POINTS SHALL BE AVAILABLE IN A LIST FORMAT WITH COMPLETE DESCRIPTIONS OF THE POINT, INCLUDING ALARMS. THE OPERATOR SHALL NOT HAVE TO REFER TO DOCUMENTATION TO DETERMINE WHAT THE POINT IS.
- VARIABLE FREQUENCY DRIVES SHALL INDICATE HAND, OFF, AUTO, AND BYPASS STATUS.
- REPLACE EXISTING TEMPERATURE ELEMENTS WITH COMPATIBLE RTD

KEYED NOTES:

- HIGH ACCURACY DIFFERENTIAL PRESSURE SENSOR REQUIRED. TO BE SIEMENS QBE DP SENSOR WITH 3-VOLT MAXIMUM OR APPROVED EQUAL WITH RANGE OF 25 PSI.
- MOTOR SPEED CONTROL, START/STOP, SPEED FEEDBACK, ALARM STATUS, AND SAFETIES SHALL BE HARD WIRED. ALL OTHER VFD INFORMATION SHALL BE VIA EMS COMM. THE POINTS SPECIFIED IN THE PROJECT MANUAL SHALL BE THE MINIMUM REQUIRED TO BE INDICATED ON THE VFD GRAPHICS. IF HO/A/B STATUS IS NOT AVAILABLE VIA INTEGRATION, PROVIDE THE REQUIRED PROGRAMMING TO INDICATE.

1 MAIN TOWER WATER CONTROL DIAGRAM

NOT TO SCALE

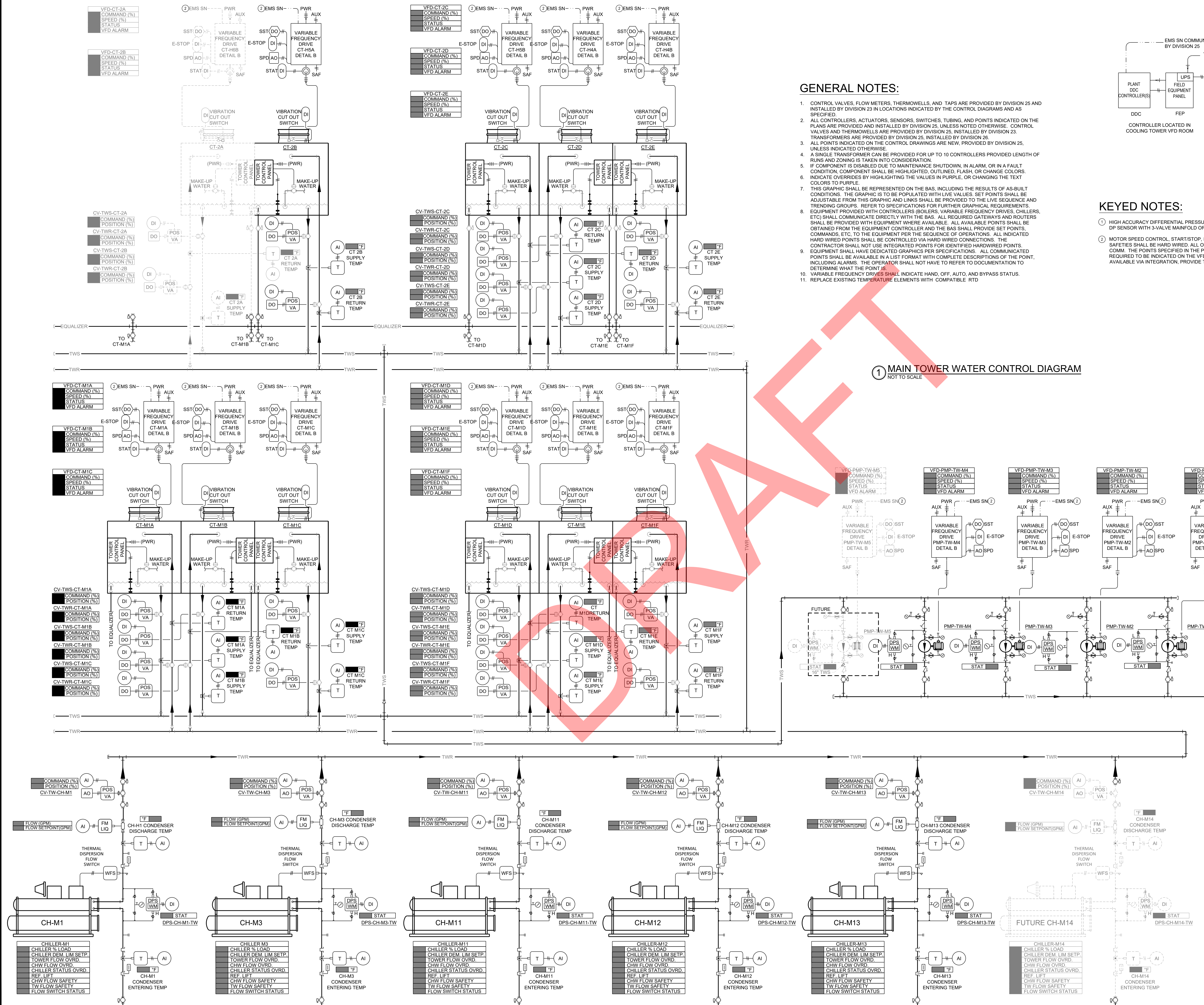

MARK	DATE	DESCRIPTION
ISSUE DATE:	09/17/21	
PROJECT NUMBER:	70-19-0025	
SHEET TITLE: MAIN PLANT TOWER WATER CONTROL DIAGRAM		
SHEET NUMBER: ATC200		

PRELIMINARY
FOR REVIEW ONLY

ENGINEER SEAL

INITIAL MODERNIZATION SOLUTION
LOUISIANA STATE UNIVERSITY
LOUISIANA ENERGY PARTNERS
BATON ROUGE, LOUISIANA

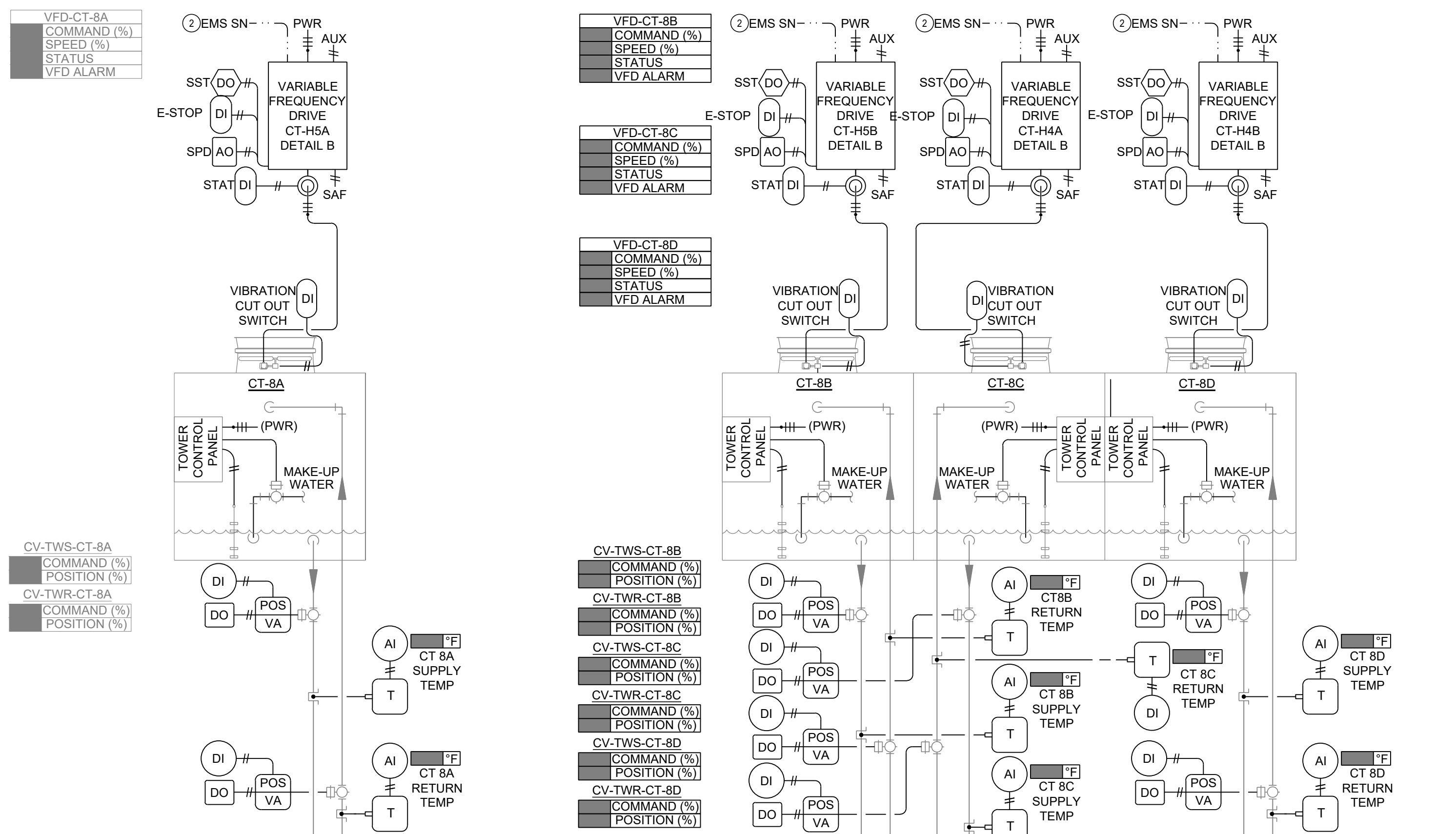

GENERAL NOTES:

- CONTROL VALVES, FLOW METERS, THERMOWELLS, AND TAPS ARE PROVIDED BY DIVISION 25 AND INSTALLED BY DIVISION 23 IN LOCATIONS INDICATED BY THE CONTROL DIAGRAMS AND AS SPECIFIED.
- ALL CONTROLLERS, ACTUATORS, SENSORS, SWITCHES, TUBING, AND POINTS INDICATED ON THE PLANS ARE PROVIDED AND INSTALLED BY DIVISION 25, UNLESS NOTED OTHERWISE. CONTROL VALVES AND THERMOWELLS ARE PROVIDED BY DIVISION 25, INSTALLED BY DIVISION 23. TRANSFORMERS ARE PROVIDED BY DIVISION 25, INSTALLED BY DIVISION 26.
- ALL POINTS INDICATED ON THE CONTROL DRAWINGS ARE NEW, PROVIDED BY DIVISION 25, UNLESS INDICATED OTHERWISE.
- A SINGLE TRANSFORMER CAN BE PROVIDED FOR UP TO 10 CONTROLLERS PROVIDED LENGTH OF RUNS AND ZONING IS TAKEN INTO CONSIDERATION.
- IF COMPONENT IS DISABLED DUE TO MAINTENANCE SHUTDOWN, IN ALARM, OR IN A FAULT CONDITION, COMPONENT SHALL BE HIGHLIGHTED, OUTLINED, FLASH OR CHANGE COLORS.
- INDICATE OVERRIDES BY HIGHLIGHTING THE VALUES IN PURPLE, OR CHANGING THE TEXT COLORS TO PURPLE.
- THIS GRAPHIC SHALL BE REPRESENTED ON THE BAS, INCLUDING THE RESULTS OF AS-BUILT CONDITIONS. THE GRAPHIC IS TO BE POPULATED WITH LIVE VALUES. SET POINTS SHALL BE ADJUSTABLE FROM THIS GRAPHIC AND LINKS SHALL BE PROVIDED TO THE LIVE SEQUENCE AND TRENDS GROUPS. REFER TO SPECIFICATIONS FOR FURTHER GRAPHICAL REQUIREMENTS.
- EQUIPMENT PROVIDED WITH CONTROLLERS (BOILERS, VARIABLE FREQUENCY DRIVES, CHILLERS, ETC) SHALL COMMUNICATE DIRECTLY WITH THE BAS. ALL REQUIRED GATEWAYS AND ROUTERS SHALL BE PROVIDED WITH EQUIPMENT WHERE AVAILABLE. ALL AVAILABLE POINTS SHALL BE OBTAINED FROM THE EQUIPMENT CONTROLLER AND THE BAS SHALL PROVIDE SET POINTS, COMMANDS, ETC. TO THE EQUIPMENT PER THE SEQUENCE OF OPERATIONS. ALL INDICATED HARD WIRED POINTS SHALL BE CONTROLLED VIA HARD WIRED CONNECTIONS. THE CONTRACTOR SHALL NOT USE INTEGRATED POINTS FOR IDENTIFIED HARDWIRED POINTS.
- EQUIPMENT SHALL HAVE DEDICATED GRAPHICS PER SPECIFICATIONS. ALL COMMUNICATED POINTS SHALL BE AVAILABLE IN A LIST FORMAT WITH COMPLETE DESCRIPTIONS OF THE POINT, INCLUDING ALARMS. THE OPERATOR SHALL NOT HAVE TO REFER TO DOCUMENTATION TO DETERMINE WHAT THE POINT IS.
- VARIABLE FREQUENCY DRIVES SHALL INDICATE HAND, OFF, AUTO, AND BYPASS STATUS.
- REPLACE EXISTING TEMPERATURE ELEMENTS WITH COMPATIBLE RTD.

KEYED NOTES:

- HIGH ACCURACY DIFFERENTIAL PRESSURE SENSOR REQUIRED, TO BE SIEMENS QBE DP SENSOR WITH 3-VALVE MAINFOLD OR APPROVED EQUAL WITH RANGE OF 25 PSI.
- MOTOR SPEED CONTROL, START/STOP, SPEED FEEDBACK, ALARM STATUS, AND SAFETIES SHALL BE HARD WIRED. ALL OTHER VFD INFORMATION SHALL BE VIA EMS COMM. THE POINTS SPECIFIED IN THE PROJECT MANUAL SHALL BE THE MINIMUM REQUIRED TO BE INDICATED ON THE VFD GRAPHICS. IF H/O/A/B STATUS IS NOT AVAILABLE VIA INTEGRATION, PROVIDE THE REQUIRED PROGRAMMING TO INDICATE.

1 MAIN TOWER WATER CONTROL DIAGRAM
NOT TO SCALE

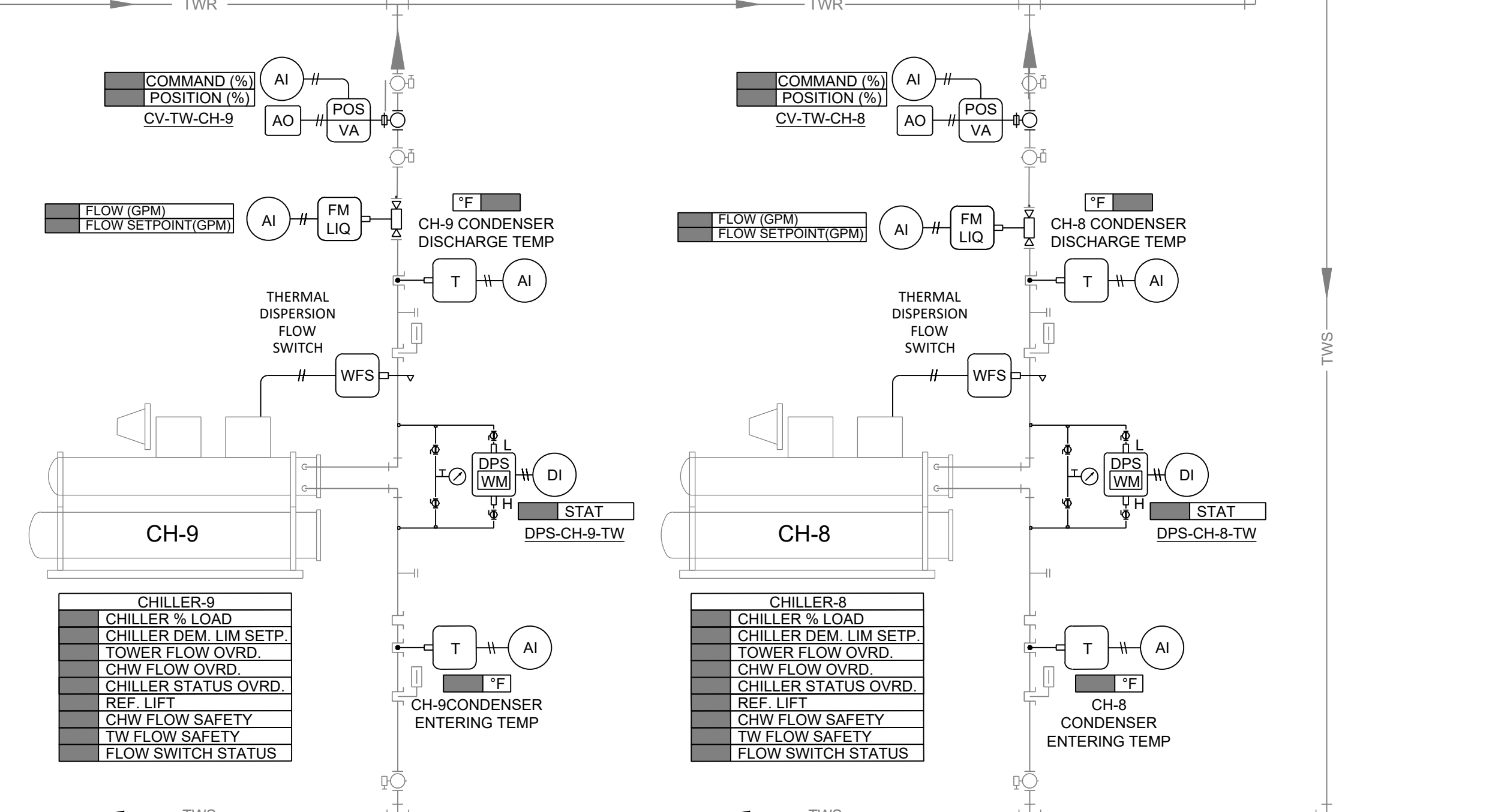
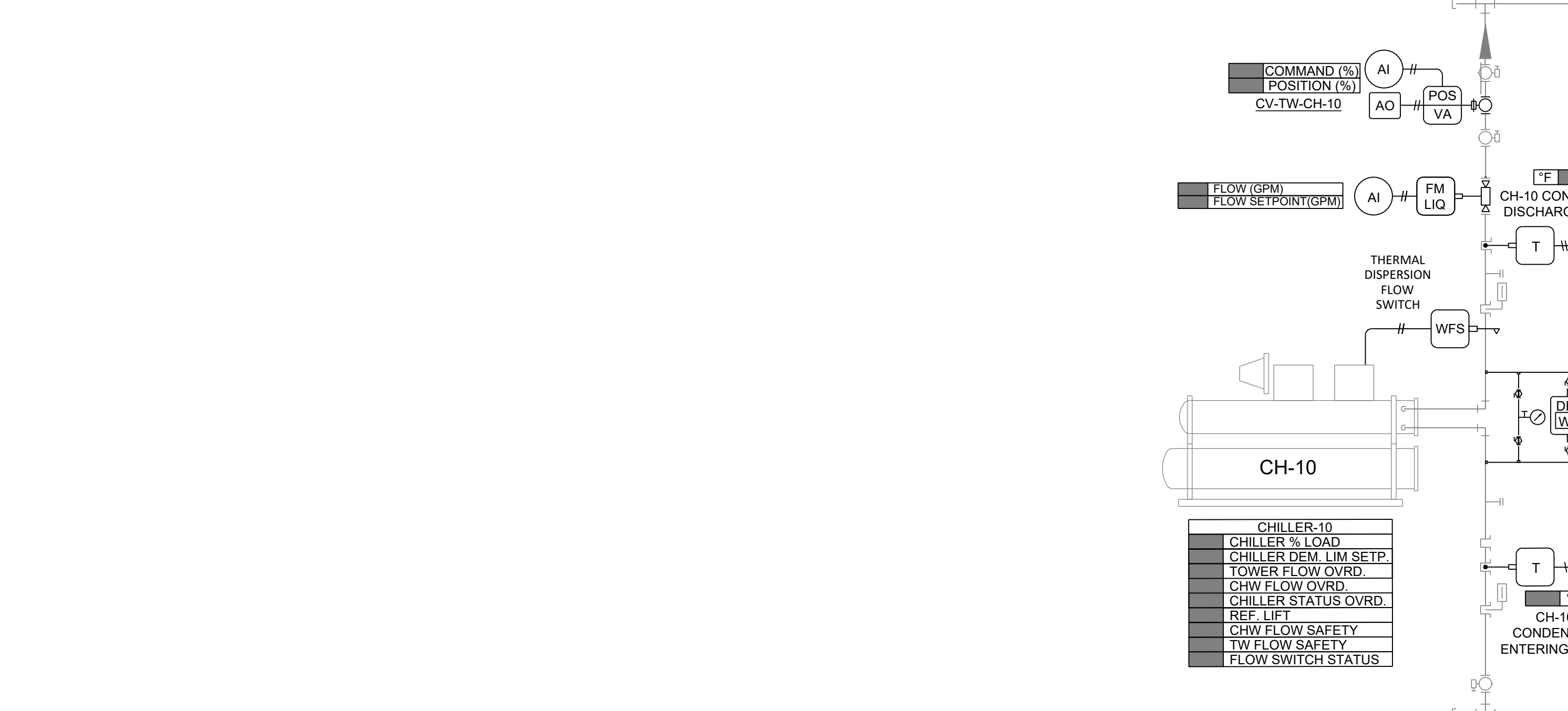
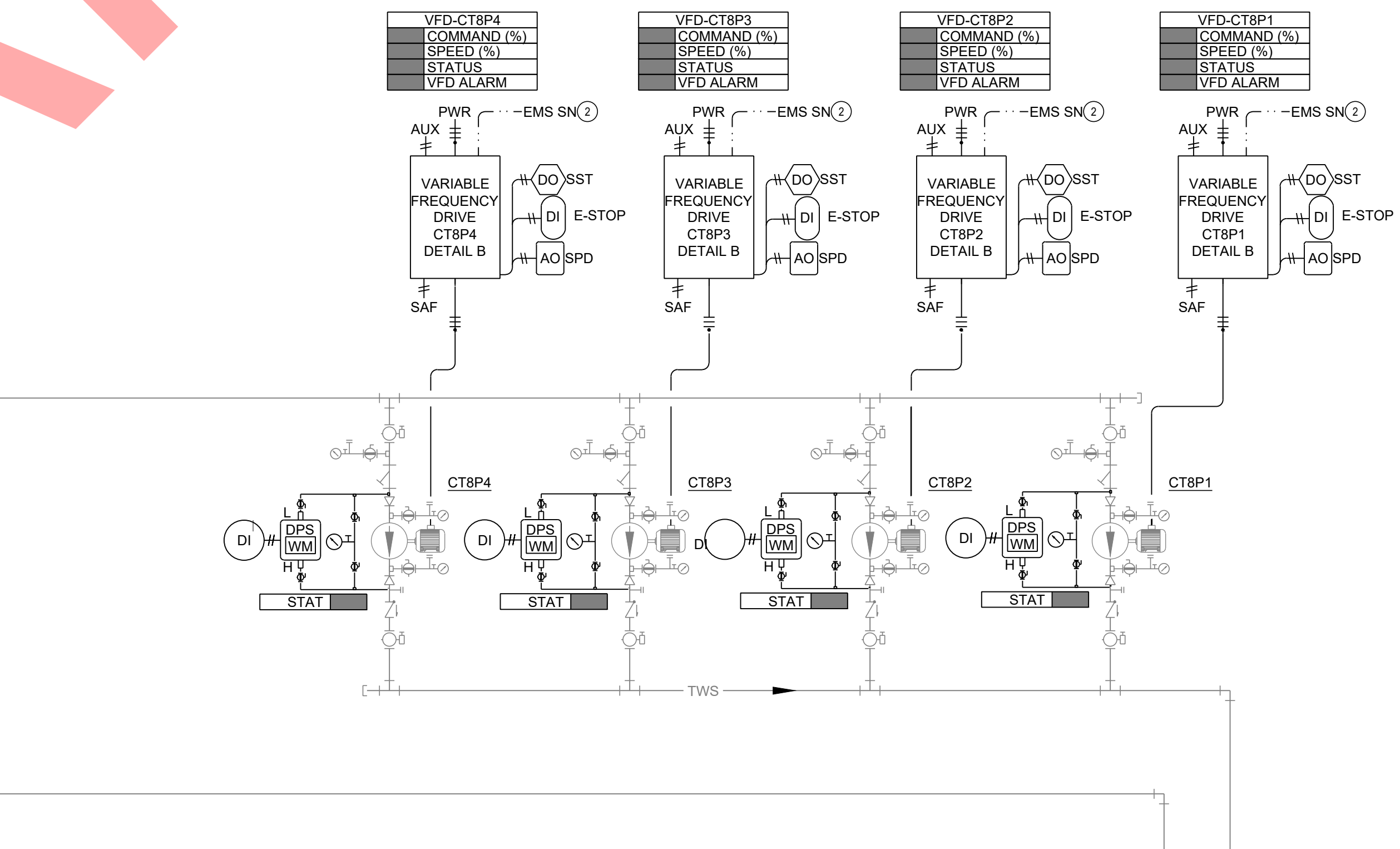
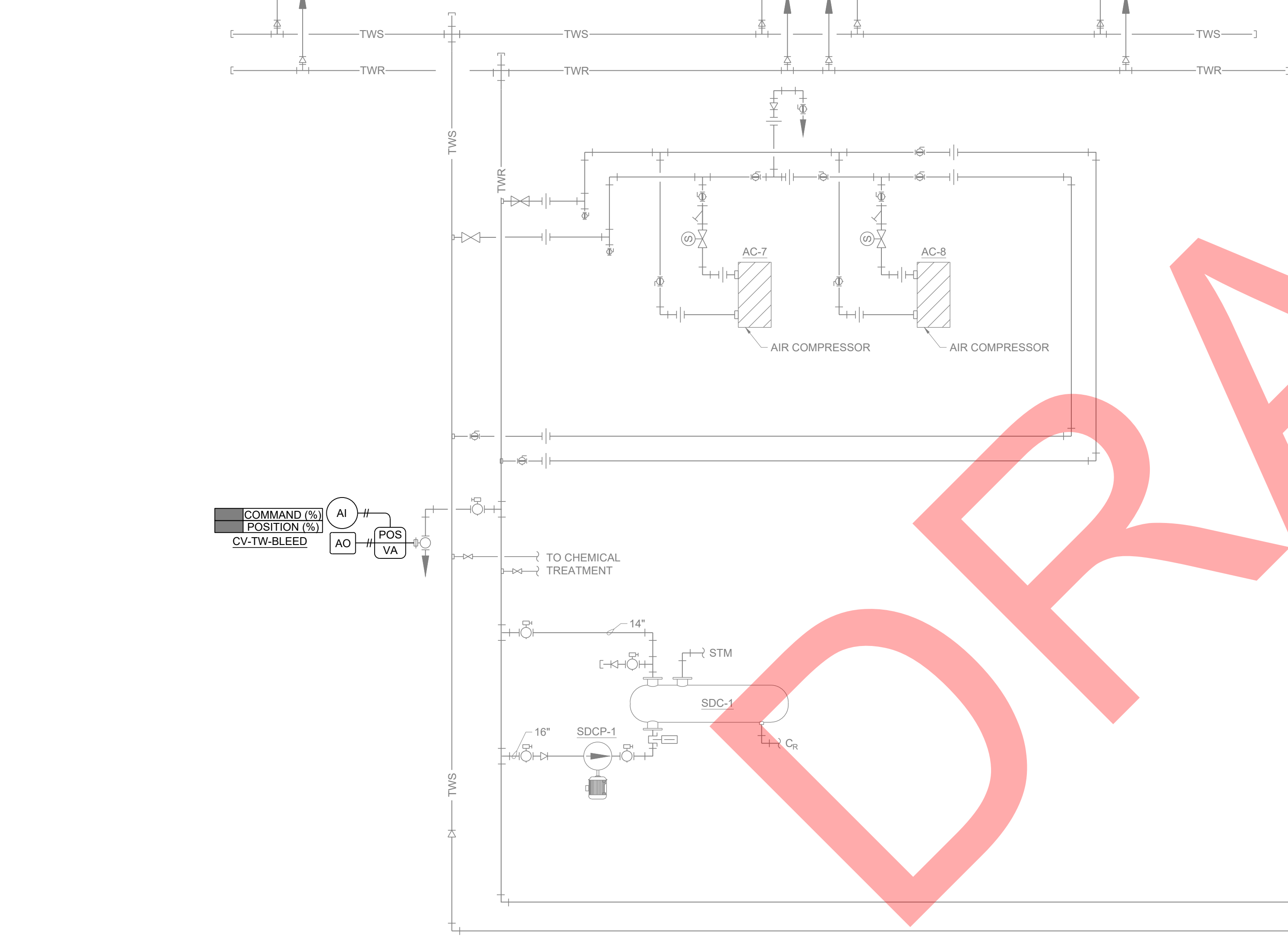

MARK	DATE	DESCRIPTION
ISSUE DATE:	09/17/21	
PROJECT NUMBER:	70-19-0025	
SHEET TITLE: MAIN PLANT TOWER WATER CONTROL DIAGRAM CONT.		
SHEET NUMBER: ATC201		

PRELIMINARY FOR REVIEW ONLY

ENGINEER SEAL

INITIAL MODERNIZATION SOLUTION
LOUISIANA STATE UNIVERSITY
LOUISIANA ENERGY PARTNERS
BATON ROUGE, LOUISIANA

GENERAL NOTES:

- CONTROL VALVES, FLOW METERS, THERMOWELLS, AND TAPS ARE PROVIDED BY DIVISION 25 AND INSTALLED BY DIVISION 23 IN LOCATIONS INDICATED BY THE CONTROL DIAGRAMS AND AS SPECIFIED.
- ALL CONTROLLERS, ACTUATORS, SENSORS, SWITCHES, TUBING, AND POINTS INDICATED ON THE PLANS ARE PROVIDED AND INSTALLED BY DIVISION 25, UNLESS NOTED OTHERWISE. CONTROL VALVES AND THERMOWELLS ARE PROVIDED BY DIVISION 25, INSTALLED BY DIVISION 26. TRANSFORMERS ARE PROVIDED BY DIVISION 25, INSTALLED BY DIVISION 26, UNLESS INDICATED OTHERWISE.
- A SINGLE TRANSFORMER CAN BE PROVIDED FOR UP TO 10 CONTROLLERS PROVIDED LENGTH OF RUNS AND ZONING IS TAKEN INTO CONSIDERATION.
- IF COMPONENT IS DISABLED DUE TO MAINTENANCE SHUTDOWN, IN ALARM, OR IN A FAULT CONDITION, COMPONENT SHALL BE HIGHLIGHTED, OUTLINED, FLASH, OR CHANGE COLORS.
- INDICATE OVERRIDES BY HIGHLIGHTING THE VALUES IN PURPLE, OR CHANGING THE TEXT COLORS TO PURPLE.
- THIS GRAPHIC SHALL BE REPRESENTED ON THE BAS, INCLUDING THE RESULTS OF AS-BUILT CONDITIONS. THE GRAPHIC IS TO BE POPULATED WITH LIVE VALUES. SET POINTS SHALL BE ADJUSTABLE FROM THIS GRAPHIC AND LINKS SHALL BE PROVIDED TO THE LIVE SEQUENCE AND TRENDS GROUPS. REFER TO SPECIFICATIONS FOR FURTHER GRAPHICAL REQUIREMENTS.
- EQUIPMENT PROVIDED WITH CONTROLLERS (BOILERS, VARIABLE FREQUENCY DRIVES, CHILLERS, ETC) SHALL COMMUNICATE DIRECTLY WITH THE BAS. ALL REQUIRED GATEWAYS AND ROUTERS SHALL BE PROVIDED WITH EQUIPMENT WHERE AVAILABLE. ALL AVAILABLE POINTS SHALL BE OBTAINED FROM THE EQUIPMENT CONTROLLER AND THE BAS SHALL PROVIDE SET POINTS, COMMANDS, ETC. TO THE EQUIPMENT PER THE SEQUENCE OF OPERATIONS. ALL INDICATED HARD WIRED POINTS SHALL BE CONTROLLED VIA HARD WIRED CONNECTIONS. THE CONTRACTOR SHALL NOT USE INTEGRATED POINTS FOR IDENTIFIED HARDWIRED POINTS.
- EQUIPMENT SHALL HAVE DEDICATED GRAPHICS PER SPECIFICATIONS. ALL COMMUNICATED POINTS SHALL BE AVAILABLE IN LIST FORMAT WITH COMPLETE DESCRIPTIONS OF THE POINT, INCLUDING ALARMS. THE OPERATOR SHALL NOT HAVE TO REFER TO DOCUMENTATION TO DETERMINE WHAT THE POINT IS.
- VARIABLE FREQUENCY DRIVES SHALL INDICATE HAND, OFF, AUTO, AND BYPASS STATUS.
- REPLACE EXISTING TEMPERATURE ELEMENTS WITH COMPATIBLE RTD

KEYED NOTES:

- HIGH ACCURACY DIFFERENTIAL PRESSURE SENSOR REQUIRED, TO BE SIEMENS QBE DP SENSOR WITH 3-VALVE MAINFOLD OR APPROVED EQUAL WITH RANGE OF 25 PSI.
- MOTOR SPEED CONTROL, START/STOP, SPEED FEEDBACK, ALARM STATUS, AND SAFETIES SHALL BE HARD WIRED. ALL OTHER VFD INFORMATION SHALL BE VIA EMS COMM. THE POINTS SPECIFIED IN THE PROJECT MANUAL SHALL BE THE MINIMUM REQUIRED TO BE INDICATED ON THE VFD GRAPHICS. IF H0V03 STATUS IS NOT AVAILABLE VIA INTEGRATION, PROVIDE THE REQUIRED PROGRAMMING TO INDICATE.

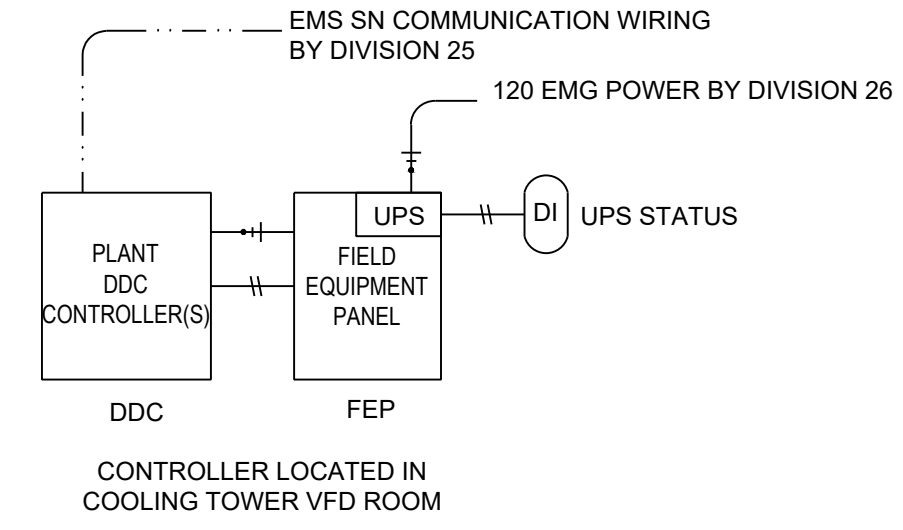

1 HIGHLAND TOWER WATER CONTROL DIAGRAM
NOT TO SCALE

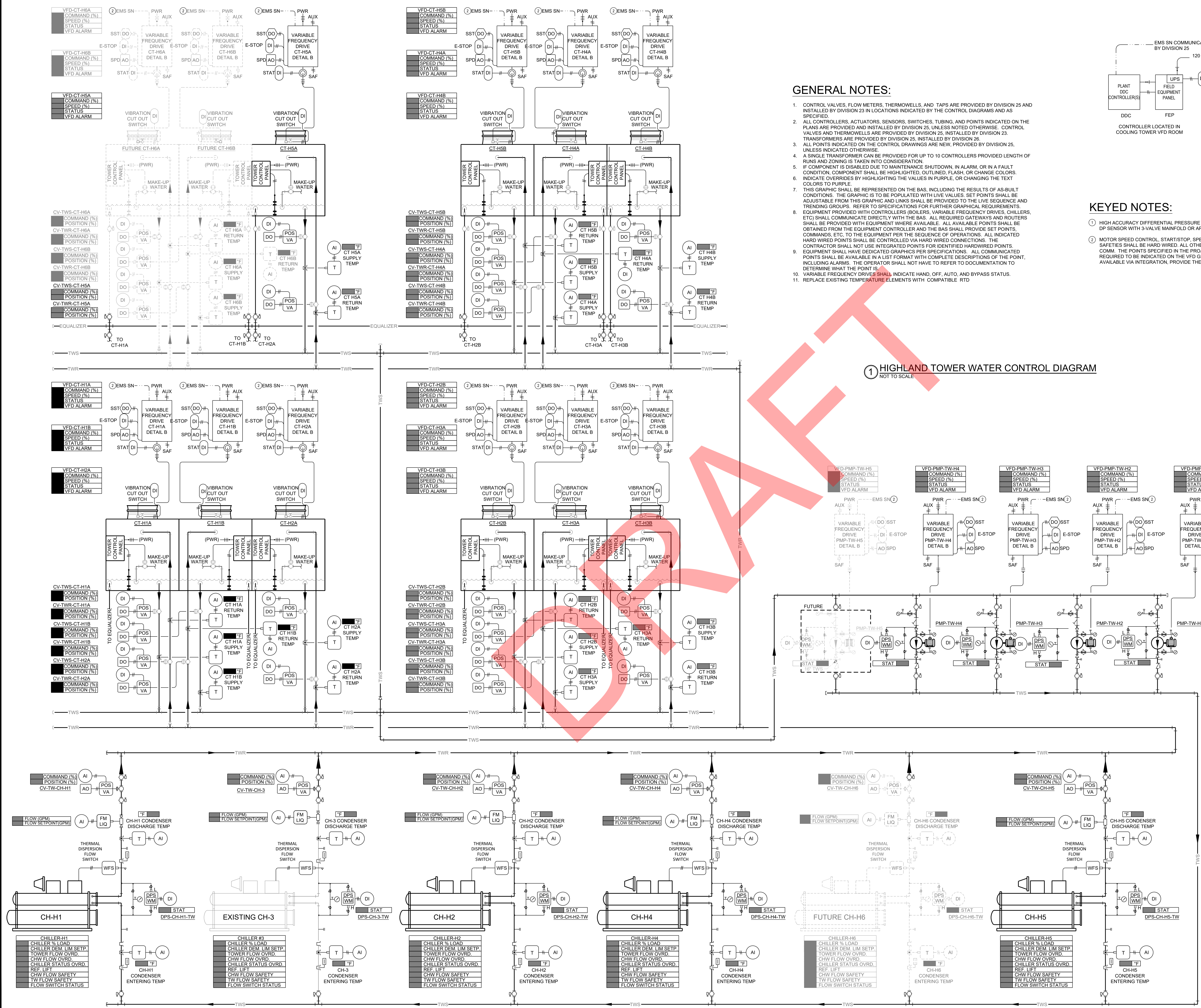

MARK	DATE	DESCRIPTION
ISSUE DATE:	09/17/21	
PROJECT NUMBER:	70-19-0025	
SHEET TITLE: HIGHLAND PLANT TOWER WATER CONTROL DIAGRAM		
SHEET NUMBER: ATC202		

PRELIMINARY
FOR REVIEW ONLY

ENGINEER SEAL

INITIAL MODERNIZATION SOLUTION
LOUISIANA STATE UNIVERSITY
LOUISIANA ENERGY PARTNERS
 BATON ROUGE, LOUISIANA

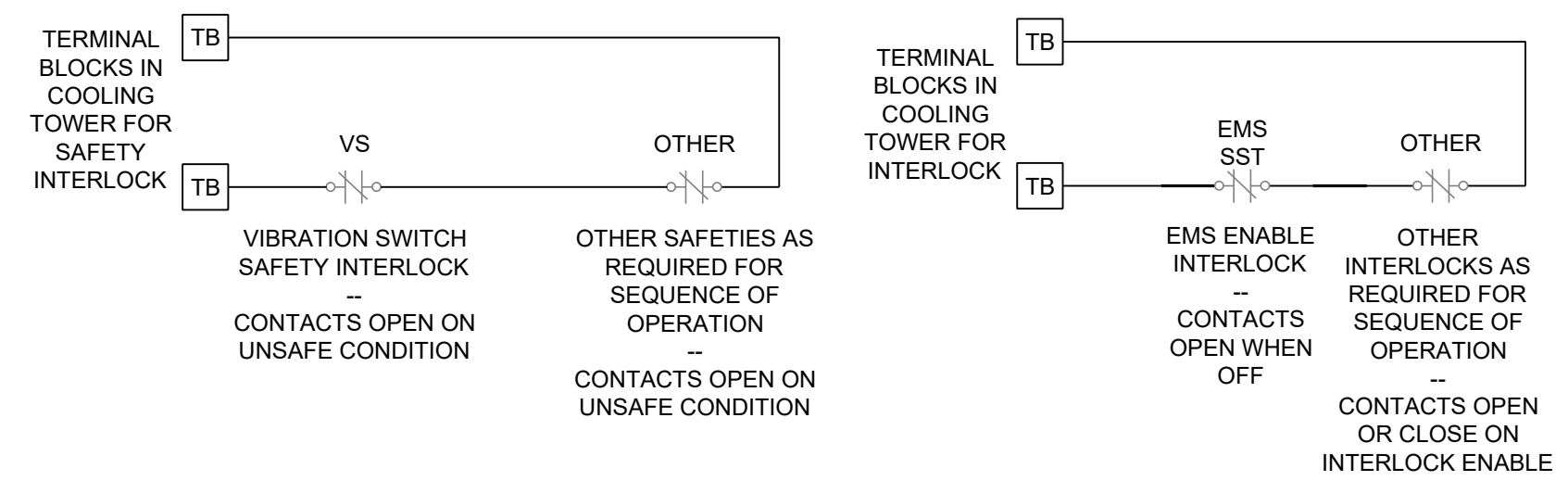

5 COOLING TOWER(S) INTERLOCKS
NOT TO SCALE

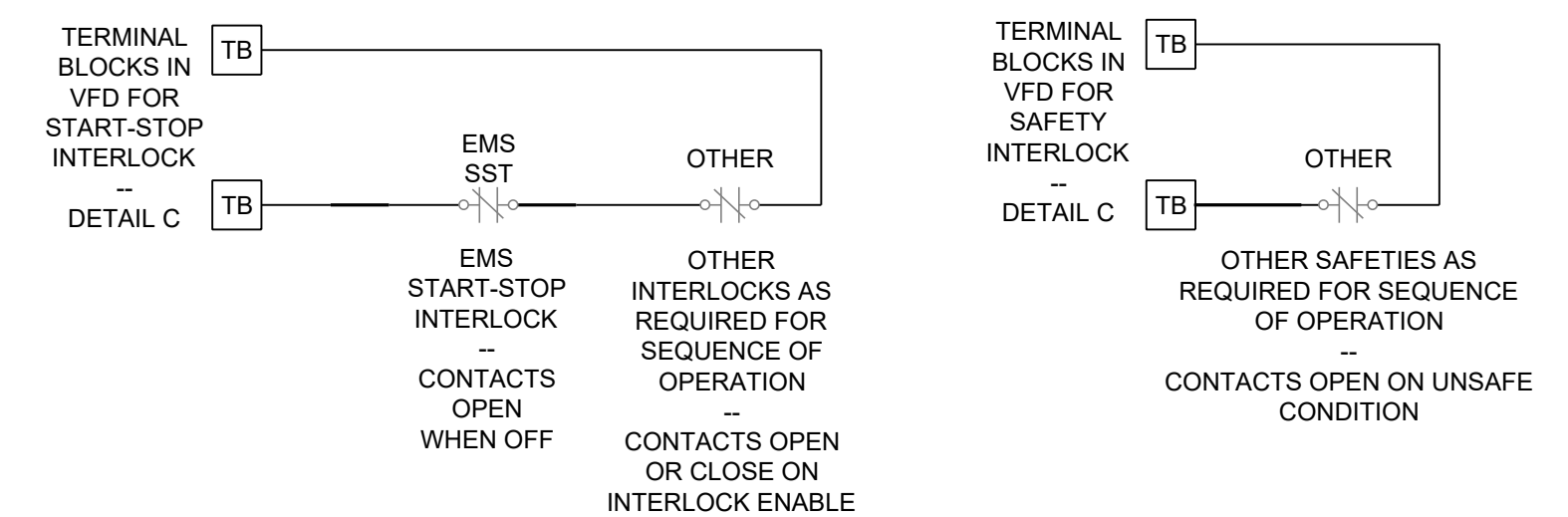

2 CONDENSER WATER PUMP(S) VFD INTERLOCKS
NOT TO SCALE

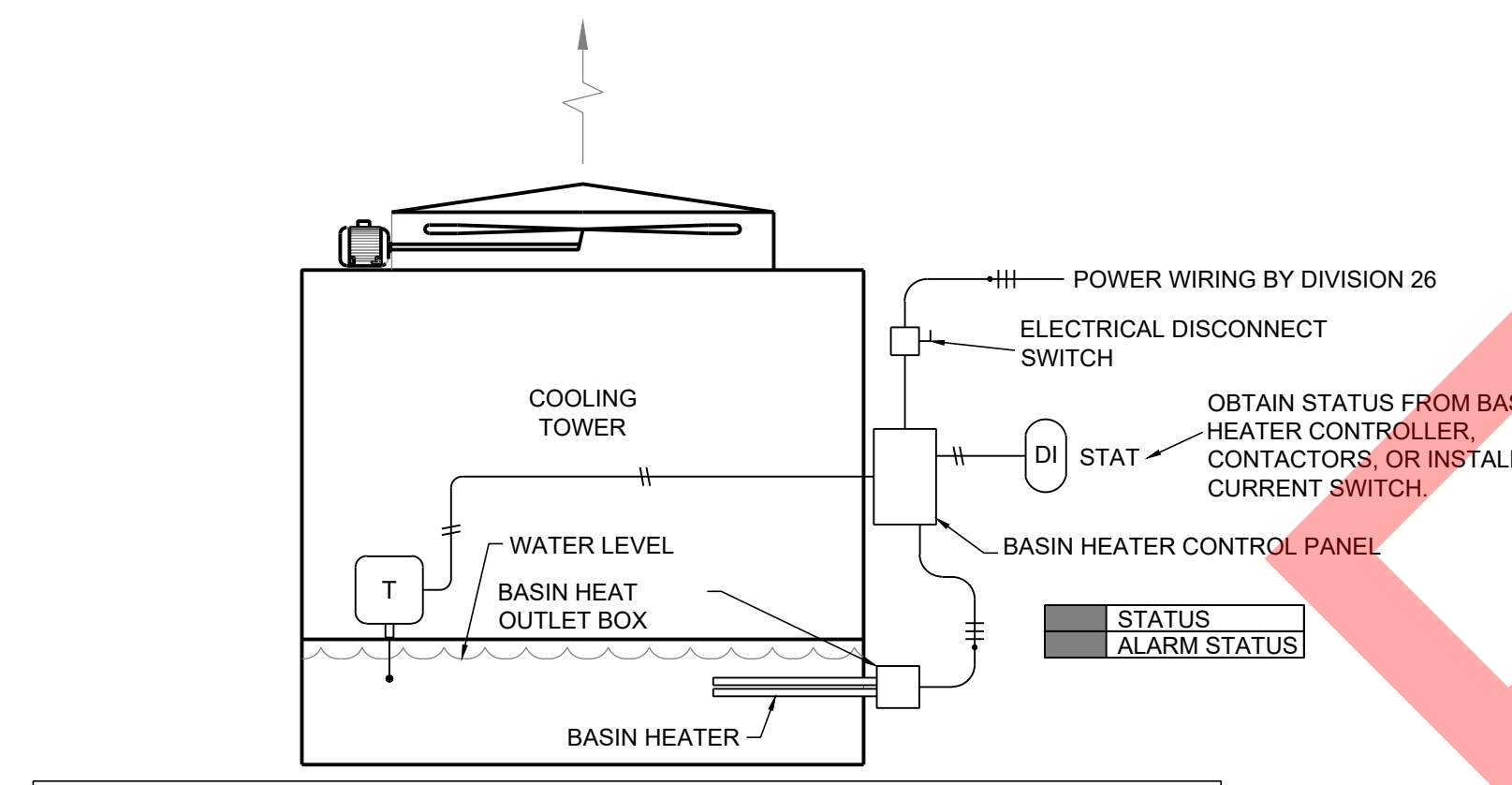

COOLING TOWER BASIN HEAT SEQUENCE OF OPERATION:
BASIN HEAT CONTROL PANEL SHALL SEQUENCE BASIN HEATING ELEMENTS PER THE MANUFACTURERS SEQUENCE TO PREVENT THE COOLING TOWER BASIN TEMPERATURE FROM DECREASING BELOW SET POINT. BASIN HEAT PANEL PREVENTS HEATER ELEMENTS FROM ENERGIZING IF BASIN WATER LEVEL IS TOO LOW. BAS SHALL MONITOR THE SYSTEM FOR OPERATIONAL STATUS, RUN TIME, AND GENERAL ALARM. IF OAT > 40°F AND HEATER IS ENABLED, AN ENABLED BASIN ALARM SHALL BE REPORTED AT THE BAS.

3 COOLING TOWER BASIN HEAT CONTROL DIAGRAM
NOT TO SCALE

TRENDING GROUPS:

- 1 TOWER TEMP CONTROL
- 2 TOWER STAGING CONTROL
- 3 TOWER PUMP CONTROL
- 4 TOWER VALVE CONTROL
- 5 TOWER FAN SPEED CONTROL
- 6 CONDENSER FLOW CONTROL
- 7 CONDENSER WATER TEMP CONTROL
- 8 CONDENSER VALVE CONTROL
- 9 CONDENSER PUMP CONTROL
- 10 CHILLER LOAD
- 11 OUTSIDE AIR TEMP
- 12 PRESSURE HEAD CONTROL
- 13 CHILLER LOAD

1 MAIN TOWER WATER CONTROL SCHEDULES AND DETAILS
NOT TO SCALE

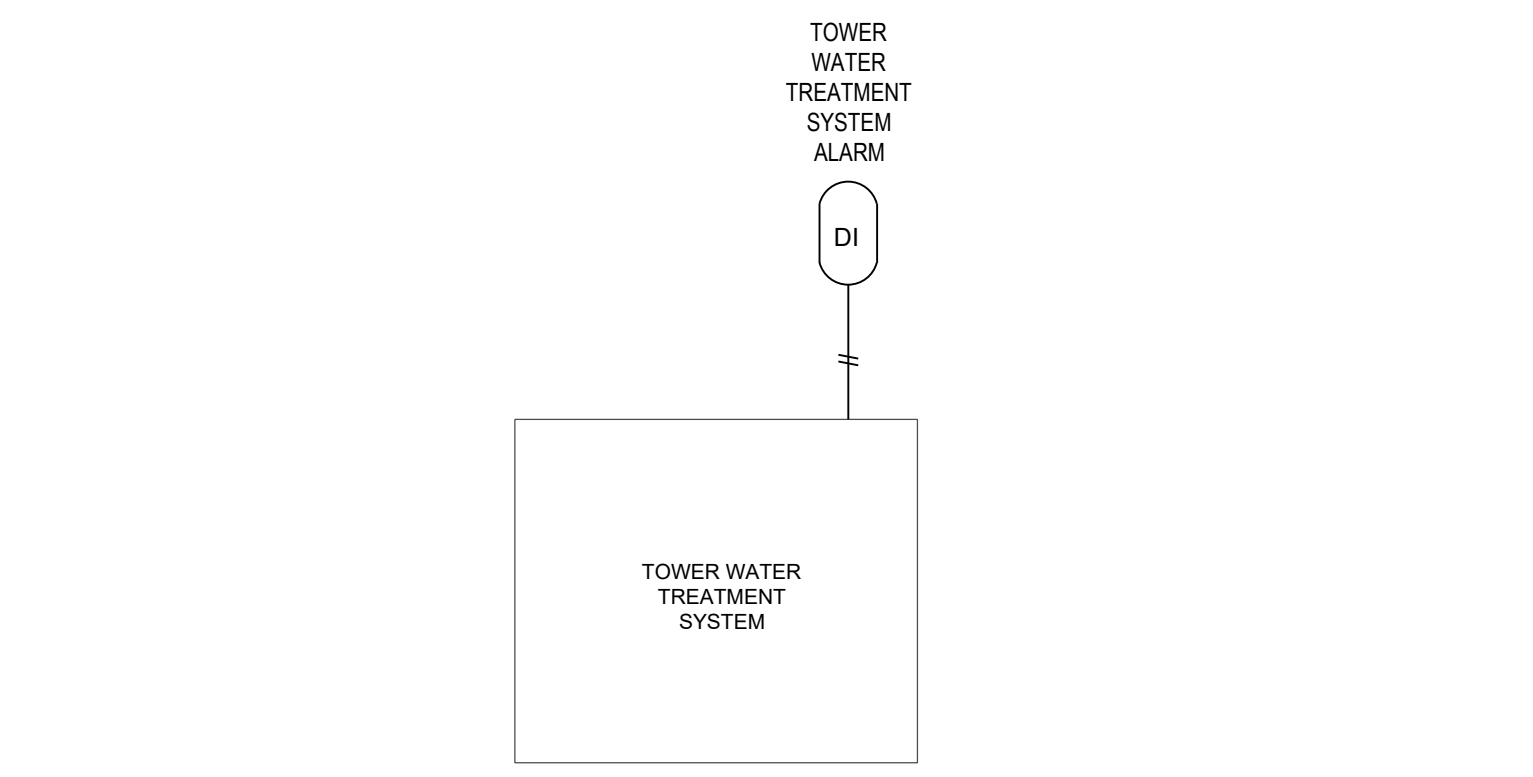

GENERAL NOTES:
1. GENERAL ALARM CONTACT MONITORED BY BAS.

4 WATER TREATMENT SYSTEM CONTROL DIAGRAM
NOT TO SCALE

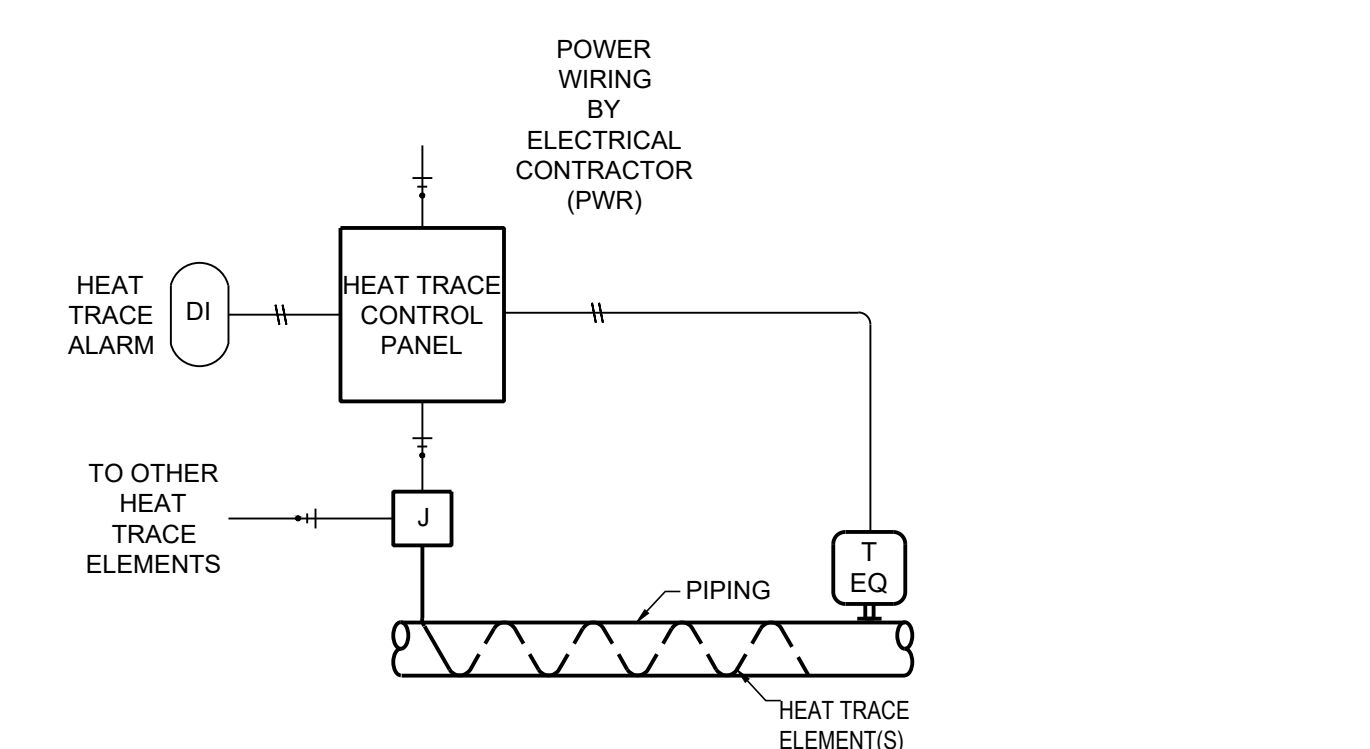

PIPING HEAT TRACE SEQUENCE OF OPERATION:
THE HEAT TRACE CONTROLLER MODULATES THE HEAT TRACE ELEMENT TO PREVENT PIPE FREEZING.
ALARM MONITORING:
AN ALARM WILL BE GENERATED AT THE EMS PC WORKSTATION IF ANY OF THE FOLLOWING OCCUR:
1. HEAT TRACE CONTROL FAILURE.

5 PIPING HEAT TRACE CONTROL DIAGRAM
NOT TO SCALE

GENERAL NOTES:

1. ATC CONTRACTOR SHALL MEET ALL REQUIREMENTS OF THE EQUIPMENT MANUFACTURER.
2. IF EQUIPMENT (CHILLERS, PUMPS, ETC.) IS DISABLED DUE TO MAINTENANCE SHUTDOWN OR A FAULT CONDITION, THE LEAD, LAG, LAG#1, ... STATUS OF THE REMAINING EQUIPMENT SHALL MOVE UP IN THE STAGING QUEUE AUTOMATICALLY. STAGING PREDETERMINED BY OPERATOR SELECTION. THE COMPONENT SHALL BE HIGHLIGHTED, OUTLINED, FLASH, OR CHANGE COLORS.
3. THIS GRAPHICAL SEQUENCE, THE SCHEDULES, AND TABLES (ALARMS, SET POINTS, MODES OF OPERATION, ETC.) SHALL BE REPRESENTED AS A GRAPHIC ON THE BAS, INCLUDING THE RESULTS OF AS-BUILT PROGRAMMING. THE GRAPHIC IS TO BE POPULATED WITH LIVE VALUES. SET POINTS SHALL BE ADJUSTABLE FROM THIS GRAPHIC AND LINKS SHALL BE PROVIDED TO TRENDING GROUPS.
4. THE SCHEDULES AND TABLES INDICATED ON THIS SHEET (ALARMS, SET POINTS, MODES OF OPERATION, ETC.) SHALL BE PROVIDED AS GRAPHICS, EDITABLE FROM THE GRAPHICS.
5. INDICATE OVERRIDES BY HIGHLIGHTING THE VALUES IN PURPLE, OR CHANGING THE TEXT COLORS TO PURPLE.
6. TRENDING GROUPS ARE IDENTIFIED ON THE SEQUENCE BY HEX NOTES. CONTRACTOR SHALL SET UP A TREND GROUP GRAPHIC FOR THE HEX NOTE DESIGNATIONS LISTED. EACH TREND GROUP SHALL CONTAIN ALL OF THE TRENDS WITH LIKE HEX NOTES. TREND GROUPS SHALL BE TRENDED AT A MINIMUM OF 30 SECOND INTERVALS. ALL OTHER POINTS ARE TO BE TRENDED AT 15 MINUTE INTERVALS AND BACKED UP AS SPECIFIED.
7. ATC CONTRACTOR SHALL TUNE ALL LOOPS AND TABLES FOR SMOOTH, STABLE OPERATION. NUMBERS INDICATED IN THESE DIAGRAMS ARE FOR A STARTING POINT ONLY. THESE DIAGRAMS REPRESENT THE BASIC FUNCTION OF THE CONTROLS SEQUENCE AND IS NOT ALL INCLUSIVE. THE ATC CONTRACTOR IS STILL REQUIRED TO PROVIDE, DEFINE, AND INDICATE ALL ALARMS, SET POINTS, AND FUNCTIONS REQUIRE TO ACHIEVE THE INTENT OF THE SEQUENCE, AND MAINTAIN ALL EQUIPMENT MANUFACTURER REQUIREMENTS.
8. EQUIPMENT PROVIDED WITH CONTROLLERS (CHILLERS, VARIABLE FREQUENCY DRIVES, ETC.) SHALL COMMUNICATE DIRECTLY WITH THE BAS. ALL REQUIRED GATEWAYS AND ROUTERS SHALL BE PROVIDED WITH EQUIPMENT WHERE AVAILABLE. ALL AVAILABLE POINTS SHALL BE OBTAINED FROM THE EQUIPMENT CONTROLLER AND THE BAS SHALL PROVIDE SET POINTS, COMMANDS, ETC. TO THE EQUIPMENT PER THE SEQUENCE OF OPERATIONS.
9. EQUIPMENT SHALL HAVE DEDICATED GRAPHICS PER SPECIFICATIONS. ALL COMMUNICATED POINTS SHALL BE AVAILABLE IN A LIST FORMAT WITH COMPLETE DESCRIPTIONS OF THE POINT, INCLUDING ALARMS. THE OPERATOR SHALL NOT HAVE TO REFER TO DOCUMENTATION TO DETERMINE WHAT THE POINT IS.

MARK	DATE	DESCRIPTION

ISSUE DATE:	09/17/21
PROJECT NUMBER:	70-19-0025
SHEET TITLE:	
MAIN PLANT WATER TOWER CONTROL SCHEDULES AND DETAILS	

SHEET NUMBER:
ATC203

PRELIMINARY
FOR REVIEW ONLY

ENGINEER SEAL

INITIAL MODERNIZATION SOLUTION
 LOUISIANA STATE UNIVERSITY
 LOUISIANA ENERGY PARTNERS
 BATON ROUGE, LOUISIANA

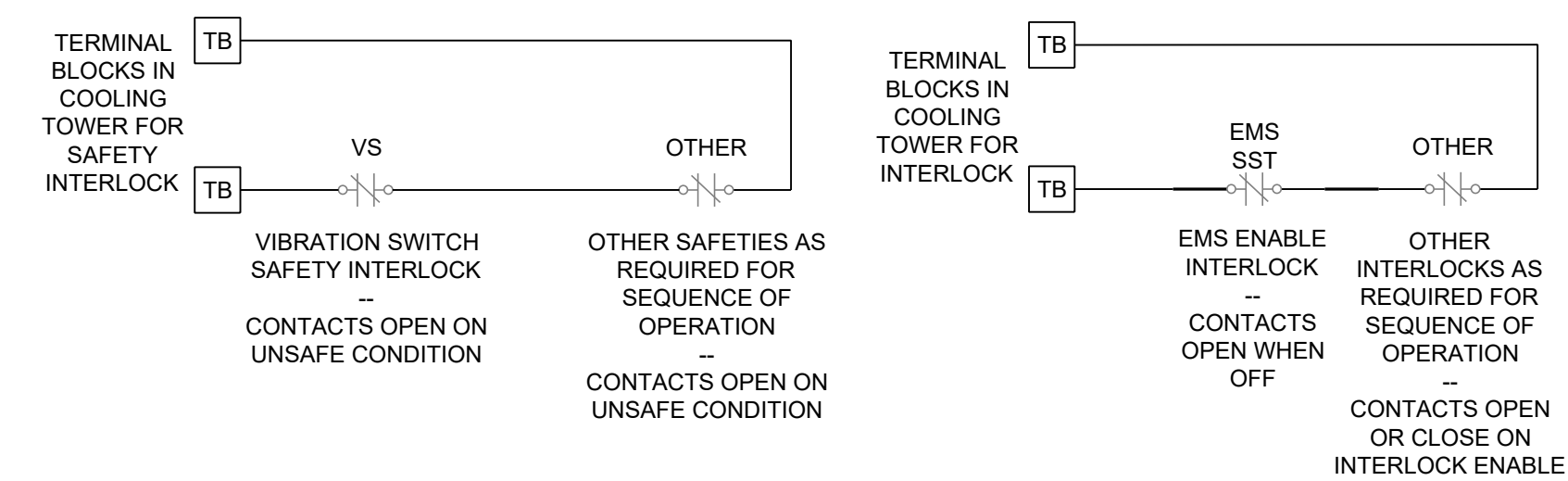

⑤ COOLING TOWER(S) INTERLOCKS
NOT TO SCALE

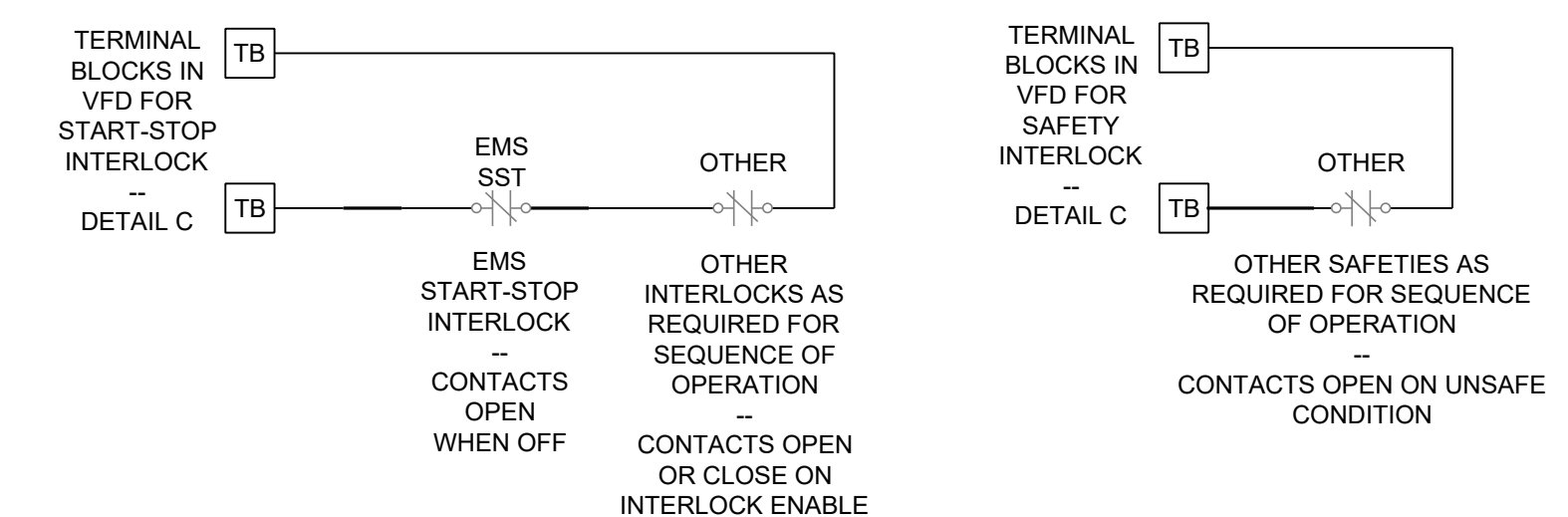

② CONDENSER WATER PUMP(S) VFD INTERLOCKS
NOT TO SCALE

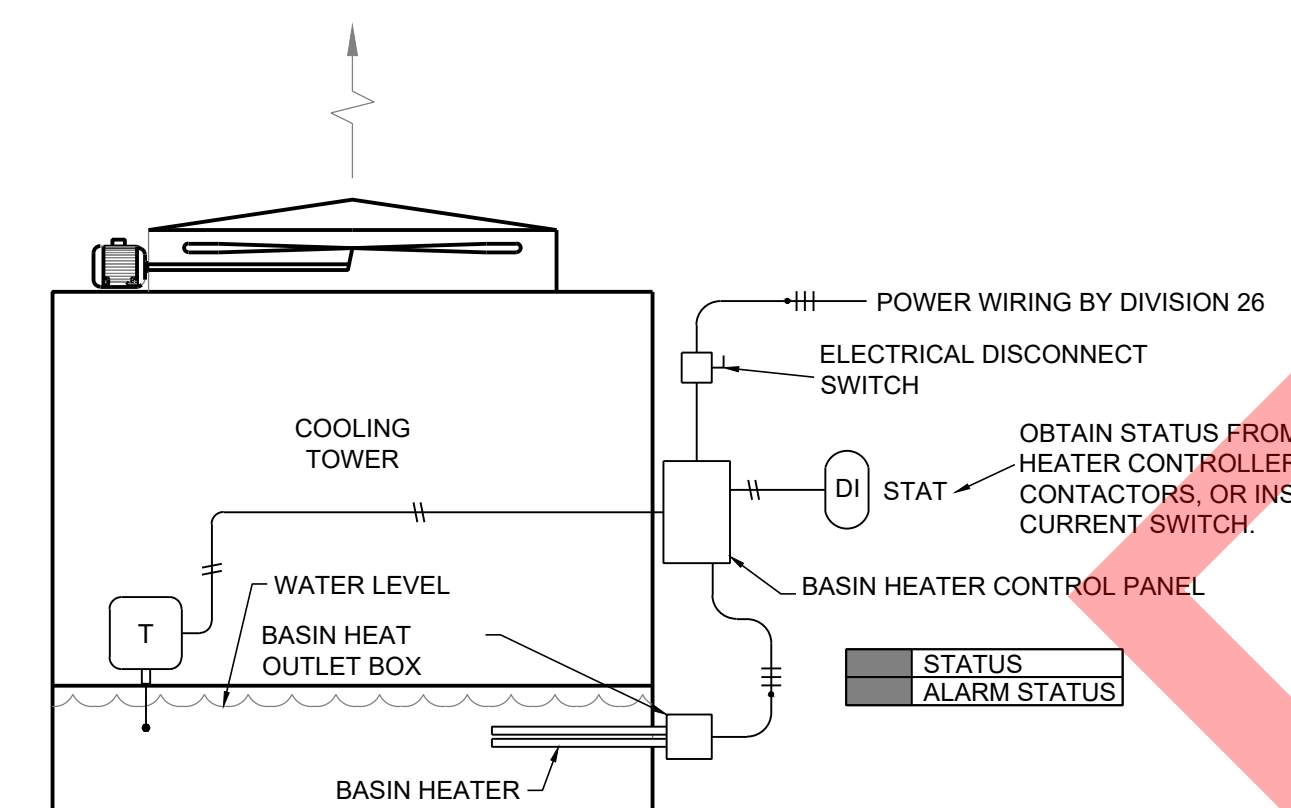

COOLING TOWER BASIN HEAT SEQUENCE OF OPERATION:
BASIN HEAT CONTROL PANEL SHALL SEQUENCE BASIN HEATING ELEMENTS PER THE MANUFACTURERS SEQUENCE TO PREVENT THE COOLING TOWER BASIN TEMPERATURE FROM DECREASING BELOW SET POINT. BASIN HEAT PANEL PREVENTS HEATER ELEMENTS FROM ENERGIZING IF BASIN WATER LEVEL IS TOO LOW. BAS SHALL MONITOR THE SYSTEM FOR OPERATIONAL STATUS, RUN TIME, AND GENERAL ALARM. IF OAT > 40°F AND HEATER IS ENABLED, AN ENABLED BASIN ALARM SHALL BE REPORTED AT THE BAS.

③ COOLING TOWER BASIN HEAT CONTROL DIAGRAM
NOT TO SCALE

TRENDING GROUPS:

- ① TOWER TEMP CONTROL
- ② TOWER STAGING CONTROL
- ③ TOWER PUMP CONTROL
- ④ TOWER VALVE CONTROL
- ⑤ TOWER FAN SPEED CONTROL
- ⑥ CONDENSER FLOW CONTROL
- ⑦ CONDENSER WATER TEMP CONTROL
- ⑧ CONDENSER VALVE CONTROL
- ⑨ CONDENSER PUMP CONTROL
- ⑩ CHILLER LOAD
- ⑪ OUTSIDE AIR TEMP
- ⑫ PRESSURE HEAD CONTROL
- ⑬ CHILLER LOAD

① HIGHLAND TOWER WATER CONTROL SCHEDULES AND DETAILS
NOT TO SCALE

GENERAL NOTES:

- 1. GENERAL ALARM CONTACT MONITORED BY BAS.

④ WATER TREATMENT SYSTEM CONTROL DIAGRAM
NOT TO SCALE

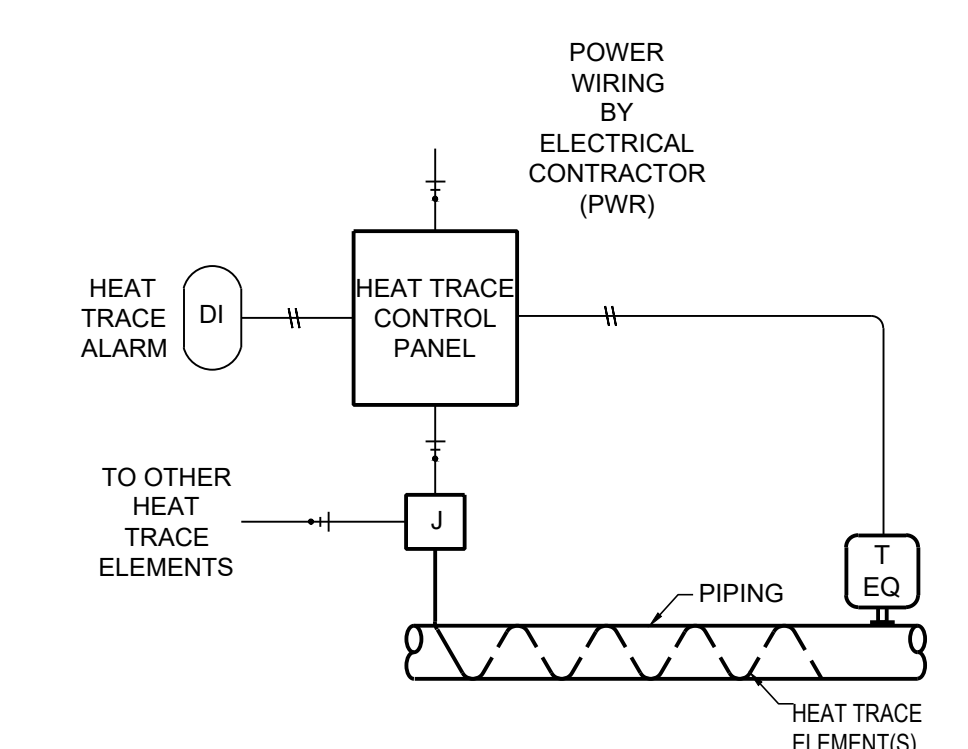

PIPING HEAT TRACE SEQUENCE OF OPERATION:
THE HEAT TRACE CONTROLLER MODULATES THE HEAT TRACE ELEMENT TO PREVENT PIPE FREEZING.
ALARM MONITORING:
AN ALARM WILL BE GENERATED AT THE EMS PC WORKSTATION IF ANY OF THE FOLLOWING OCCUR:
1. HEAT TRACE CONTROL FAILURE.

⑤ PIPING HEAT TRACE CONTROL DIAGRAM
NOT TO SCALE

GENERAL NOTES:

- 1. ATC CONTRACTOR SHALL MEET ALL REQUIREMENTS OF THE EQUIPMENT MANUFACTURER.
- 2. IF EQUIPMENT (CHILLERS, PUMPS, ETC.) IS DISABLED DUE TO MAINTENANCE SHUTDOWN OR A FAULT CONDITION, THE LEAD, LAG, LAG#1, ... STATUS OF THE REMAINING EQUIPMENT SHALL MOVE UP IN THE STAGING QUEUE AUTOMATICALLY. STAGING PREDETERMINED BY OPERATOR SELECTION. THE COMPONENT SHALL BE HIGHLIGHTED, OUTLINED, FLASH, OR CHANGE COLORS.
- 3. THIS GRAPHICAL SEQUENCE, THE SCHEDULES, AND TABLES (ALARMS, SET POINTS, MODES OF OPERATION, ETC.) SHALL BE REPRESENTED AS A GRAPHIC ON THE BAS, INCLUDING THE RESULTS OF AS-BUILT PROGRAMMING. THE GRAPHIC IS TO BE POPULATED WITH LIVE VALUES. SET POINTS SHALL BE ADJUSTABLE FROM THIS GRAPHIC AND LINKS SHALL BE PROVIDED TO TRENDING GROUPS.
- 4. THE SCHEDULES AND TABLES INDICATED ON THIS SHEET (ALARMS, SET POINTS, MODES OF OPERATION, ETC.) SHALL BE PROVIDED AS GRAPHICS, EDITABLE FROM THE GRAPHICS.
- 5. INDICATE OVERRIDES BY HIGHLIGHTING THE VALUES IN PURPLE, OR CHANGING THE TEXT COLORS TO PURPLE.
- 6. TRENDING GROUPS ARE IDENTIFIED ON THE SEQUENCE BY HEX NOTES. CONTRACTOR SHALL SET UP A TREND GROUP GRAPHIC FOR THE HEX NOTE DESIGNATIONS LISTED. EACH TREND GROUP SHALL CONTAIN ALL OF THE TRENDS WITH LIKE HEX NOTES. TREND GROUPS SHALL BE TRENDED AT A MINIMUM OF 30 SECOND INTERVALS. ALL OTHER POINTS ARE TO BE TRENDED AT 15 MINUTE INTERVALS AND BACKED UP AS SPECIFIED.
- 7. ATC CONTRACTOR SHALL TUNE ALL LOOPS AND TABLES FOR SMOOTH, STABLE OPERATION. NUMBERS INDICATED IN THESE DIAGRAMS ARE FOR A STARTING POINT ONLY. THESE DIAGRAMS REPRESENT THE BASIC FUNCTION OF THE CONTROLS SEQUENCE AND IS NOT ALL INCLUSIVE. THE ATC CONTRACTOR IS STILL REQUIRED TO PROVIDE, DEFINE, AND INDICATE ALL ALARMS, SET POINTS, AND FUNCTIONS REQUIRE TO ACHIEVE THE INTENT OF THE SEQUENCE, AND MAINTAIN ALL EQUIPMENT MANUFACTURER REQUIREMENTS.
- 8. EQUIPMENT PROVIDED WITH CONTROLLERS (CHILLERS, VARIABLE FREQUENCY DRIVES, ETC) SHALL COMMUNICATE DIRECTLY WITH THE BAS. ALL REQUIRED GATEWAYS AND ROUTERS SHALL BE PROVIDED WITH EQUIPMENT WHERE AVAILABLE. ALL AVAILABLE POINTS SHALL BE OBTAINED FROM THE EQUIPMENT CONTROLLER AND THE BAS SHALL PROVIDE SET POINTS, COMMANDS, ETC. TO THE EQUIPMENT PER THE SEQUENCE OF OPERATIONS.
- 9. EQUIPMENT SHALL HAVE DEDICATED GRAPHICS PER SPECIFICATIONS. ALL COMMUNICATED POINTS SHALL BE AVAILABLE IN A LIST FORMAT WITH COMPLETE DESCRIPTIONS OF THE POINT, INCLUDING ALARMS. THE OPERATOR SHALL NOT HAVE TO REFER TO DOCUMENTATION TO DETERMINE WHAT THE POINT IS.

MARK	DATE	DESCRIPTION

ISSUE DATE:	09/17/21
PROJECT NUMBER:	70-19-0025

SHEET TITLE:
HIGHLAND PLANT TOWER
WATER CONTROL
SCHEDULES AND DETAILS

SHEET NUMBER:
ATC204

**PRELIMINARY
FOR REVIEW ONLY**

ENGINEER SEAL

**INITIAL MODERNIZATION SOLUTION
LOUISIANA STATE UNIVERSITY
LOUISIANA ENERGY PARTNERS**
BATON ROUGE, LOUISIANA

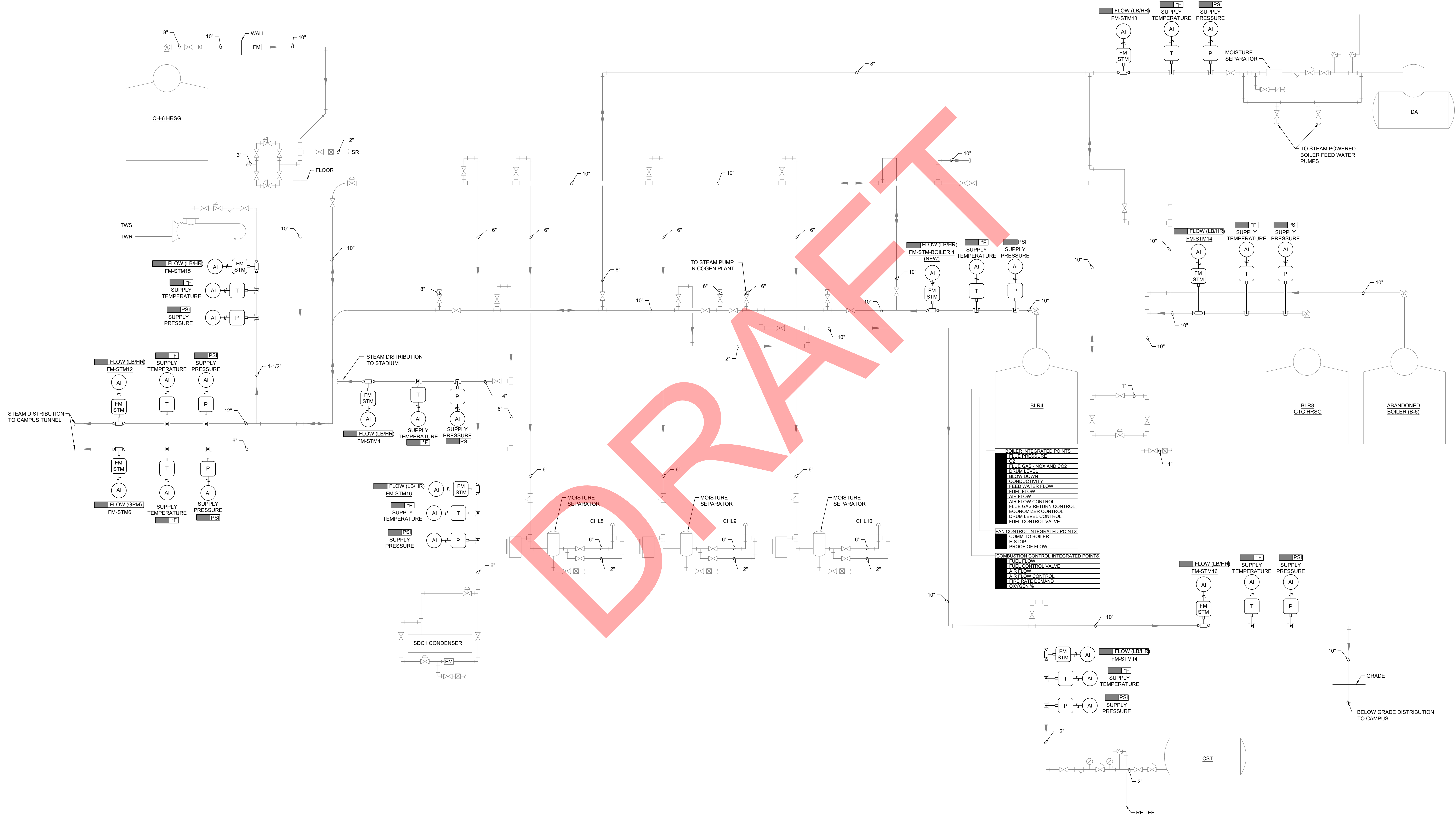

1 MAIN PLANT STEAM CONTROL DIAGRAM
SCALE: NOT TO SCALE

MARK	DATE	DESCRIPTION
------	------	-------------

ISSUE DATE:	09/17/21
-------------	----------

PROJECT NUMBER:	70-19-0025
-----------------	------------

SHEET TITLE:
**MAIN PLANT STEAM
CONTROL DIAGRAM**

SHEET NUMBER:
ATC300

**PRELIMINARY
FOR REVIEW ONLY**

ENGINEER SEAL

**INITIAL MODERNIZATION SOLUTION
LOUISIANA STATE UNIVERSITY
LOUISIANA ENERGY PARTNERS**
BATON ROUGE, LOUISIANA

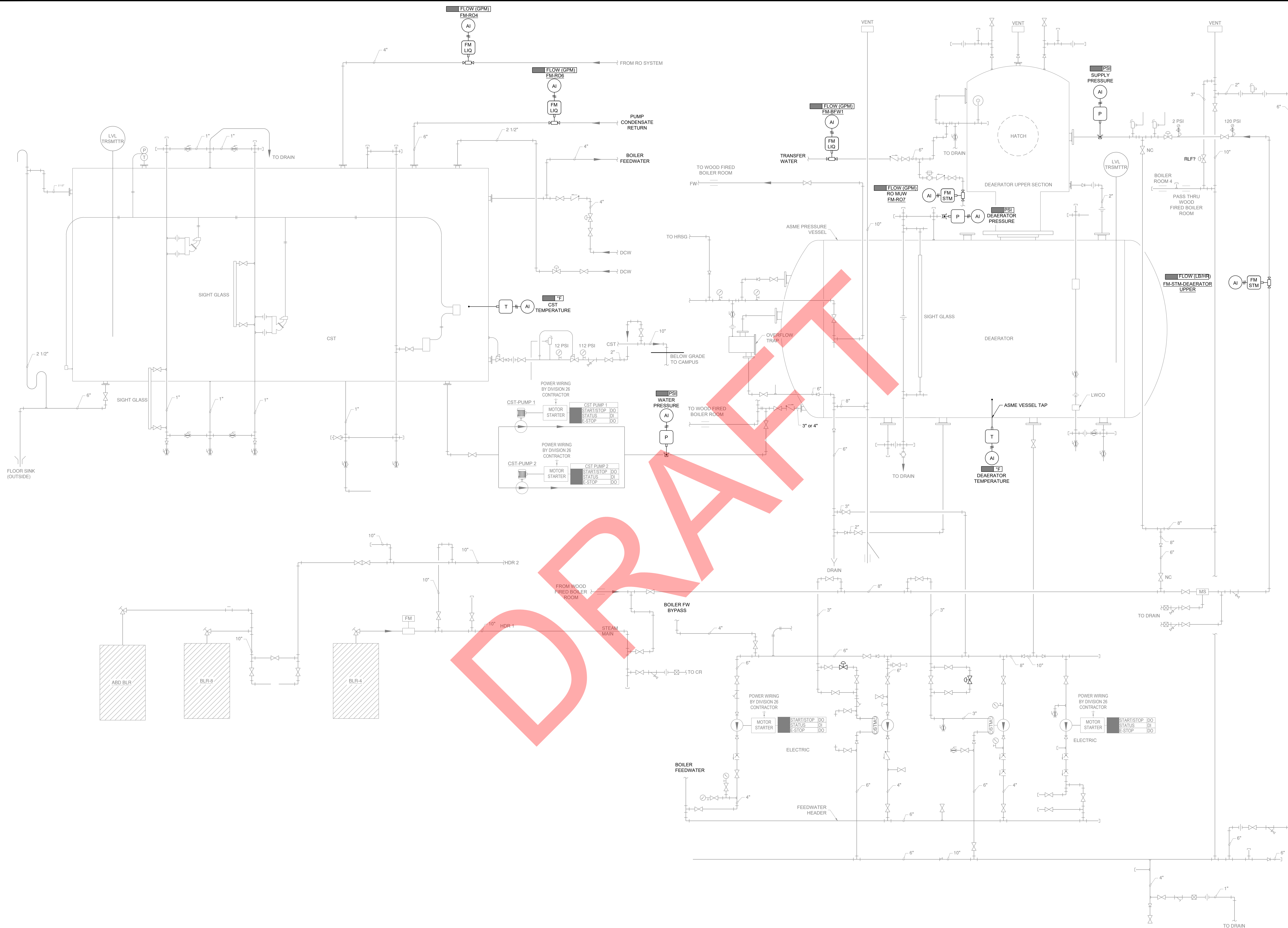

1 MAIN PLANT CST & DA CONTROL DIAGRAM
SCALE: NOT TO SCALE

MARK	DATE	DESCRIPTION
ISSUE DATE:	09/17/21	
PROJECT NUMBER:	70-19-0025	
SHEET TITLE:		
MAIN PLANT CST & DA CONTROL DIAGRAM		

SHEET NUMBER:
ATC301

PRELIMINARY
FOR REVIEW ONLY

ENGINEER SEAL

INITIAL MODERNIZATION SOLUTION
LOUISIANA STATE UNIVERSITY
LOUISIANA ENERGY PARTNERS
BATON ROUGE, LOUISIANA

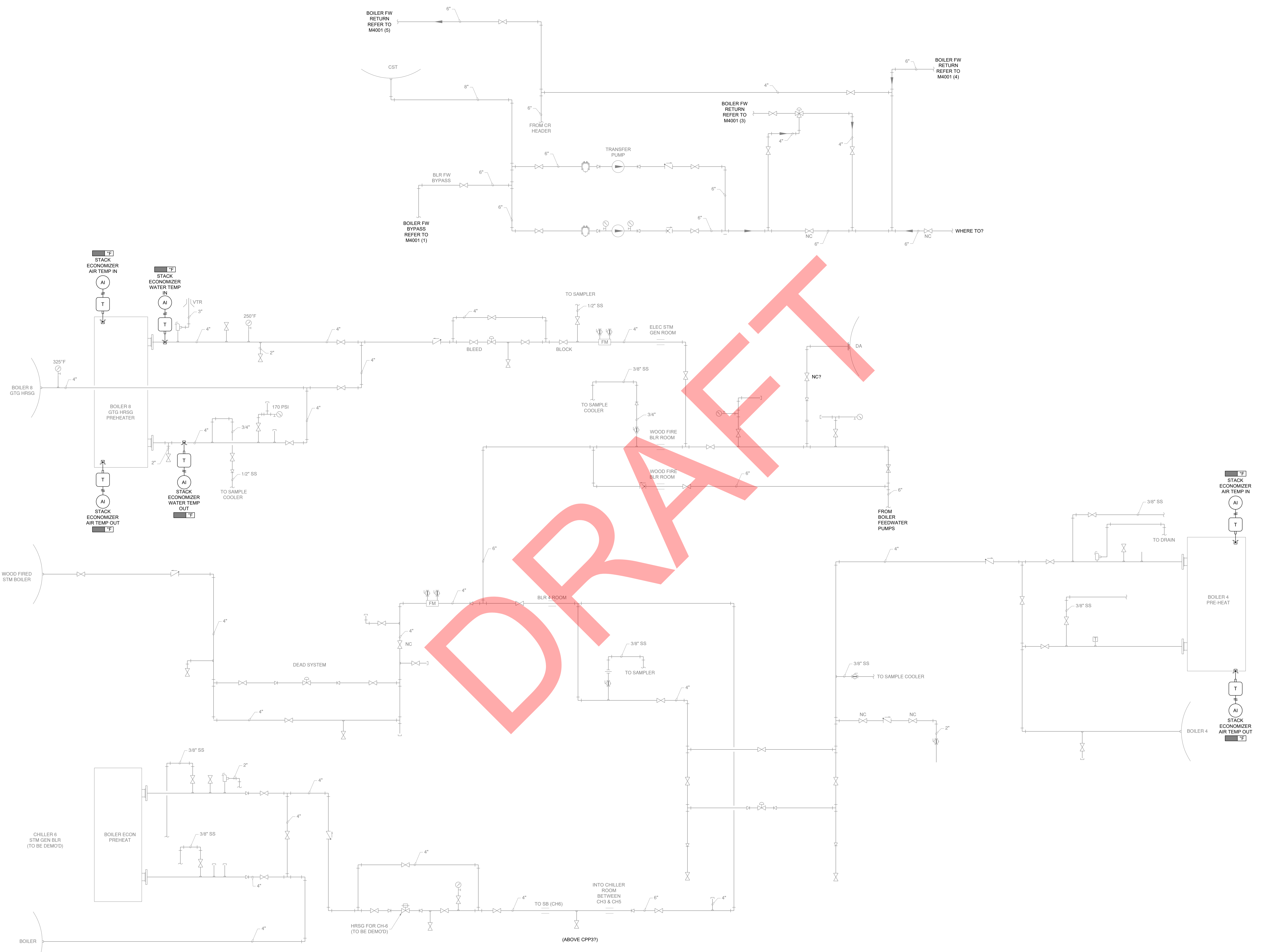

1 MAIN PLANT BOILER FEEDWATER CONTROL DIAGRAM
SCALE: NOT TO SCALE

MARK	DATE	DESCRIPTION
ISSUE DATE:	09/17/21	
PROJECT NUMBER:	70-19-0025	
SHEET TITLE:		
MAIN PLANT - PIPING DIAGRAMS - FEEDWATER - EXISTING		

SHEET NUMBER:
ATC302

**PRELIMINARY
FOR REVIEW ONLY**

ENGINEER SEAL

**INITIAL MODERNIZATION SOLUTION
LOUISIANA STATE UNIVERSITY
LOUISIANA ENERGY PARTNERS**
BATON ROUGE, LOUISIANA

MARK	DATE	DESCRIPTION

ISSUE DATE: 09/17/21

PROJECT NUMBER: 70-19-0025

SHEET TITLE:
LEGEND AND GENERAL NOTES -
ELECTRICAL

SHEET NUMBER:
E000

ELECTRICAL LEGEND

SYMBOL	DESCRIPTION	SYMBOL	DESCRIPTION	SYMBOL	DESCRIPTION
	ARCHITECTURAL LIGHT FIXTURE - CEILING MOUNTED.		DUPLEX RECEPTACLE		FIRE ALARM DUCT DETECTOR S - SUPPLY, R-RETURN, E- EXHAUST
	STRIP LINEAR LIGHT FIXTURE - CHAIN OR SURFACE MOUNTED.		DUPLEX RECEPTACLE - MOUNT RECEPTACLE ABOVE COUNTERTOP.		FIRE ALARM HORN/STROBE - WALL MOUNTED "XX" INDICATES CANDELA RATING
	DOWNLIGHT OR INCANDESCENT FIXTURE - CEILING MOUNTED.		DUPLEX RECEPTACLE - GROUND FAULT INTERRUPTING AND WEATHER PROOF WHILE IN USE		FIRE ALARM MANUAL PULL
	EXTERIOR LIGHT FIXTURE - WALL MOUNTED.		QUADRAPLEX RECEPTACLE		FIRE ALARM ADDRESSABLE CONTROL RELAY
	EXIT SIGN - CEILING MOUNTED		SPECIAL PURPOSE SIMPLEX RECEPTACLE - NEMA CONFIGURATION (VOLTAGE, AMPACITY) INDICATED		FIRE ALARM STROBE - WALL MOUNT "XX" INDICATES CANDELA RATING
	EXIT SIGN - WALL MOUNTED		JUNCTION BOX - CEILING MOUNTED		FIRE ALARM HEAT DETECTOR
	POLE MOUNTED AREA LIGHT FIXTURE		JUNCTION BOX - FLOOR MOUNTED		FIRE ALARM SMOKE DETECTOR
	EMERGENCY DUAL HEAD LIGHT FIXTURE		JUNCTION BOX - WALL/SURFACE MOUNTED		FIRE ALARM CONTROL PANEL
	SINGLE POLE SWITCH		NON-FUSED DISCONNECT SWITCH		DATA OUTLET - WALL MOUNTED
	THREE-WAY SWITCH		FUSED DISCONNECT SWITCH		TELEPHONE TERMINAL BOARD
	FOUR-WAY SWITCH		DISCONNECT SWITCH PROVIDED WITH EQUIPMENT		ACCESS CONTROL PANEL AND POWER SUPPLY
	MANUAL MOTOR STARTER WITH OVERLOADS, TOGGLE OPERATED		COMBINATION MOTOR STARTER AND DISCONNECT SWITCH		CARD READER
	DUAL-TECH OCCUPANCY SENSOR SWITCH - WALL MOUNTED.		MOTOR STARTER		ELECTRIC STRIKE
	OUTDOOR PHOTOSENSOR		ENCLOSED CIRCUIT BREAKER		DOOR CONTACT
	BRANCH CIRCUIT HOMERUN - PANEL & CIRCUIT NUMBER INDICATED		VARIABLE FREQUENCY DRIVE (BY MECHANICAL)		DOME CAMERA - CEILING MOUNTED
	CONDUIT CONCEALED UNDERGROUND OR IN/BELOW FLOOR SLAB		SURFACE MOUNTED PANELBOARD		DOME CAMERA - WALL MOUNTED
	EMERGENCY CIRCUIT IN CONDUIT		WALL/CEILING MOUNTED ELECTRICAL EQUIPMENT		INTERCOM SPEAKER - CEILING MOUNTED
	ABOVE FINISHED FLOOR ABOVE FINISHED GRADE WEATHERPROOF		PAD MOUNTED ELECTRICAL EQUIPMENT		INTERCOM MASTER STATION
	NON-SWITCHED		EMERGENCY POWER OFF PUSHBUTTON		

GENERAL ELECTRICAL DEMOLITION NOTES:

- ALL SALVAGEABLE ITEMS SUCH AS LIGHT FIXTURES, SURVEILLANCE & SECURITY EQUIPMENT, DATA RACKS & EQUIPMENT, FIRE ALARM DEVICES, ETC. THAT ARE NOT TO BE REUSED SHALL BE TURNED OVER TO THE OWNER.
- THE CONTRACTOR SHALL COORDINATE WITH THE OWNER AS TO CONSTRUCTION SCHEDULING, SERVICE INTERRUPTIONS, AND ACCESS TO WORK AREAS A MINIMUM OF (3) DAYS PRIOR TO WORK.
- ALL EXISTING BRANCH CIRCUITS NOT RE-USED SHALL BE REMOVED BACK TO PANEL. THE CIRCUIT BREAKERS SHALL BE LABELED AS SPARE AND EXISTING CONDUIT SHALL REMAIN FROM PANEL TO ABOVE ACCESSIBLE CEILING SPACE.
- THE CONTRACTOR SHALL BE RESPONSIBLE FOR ALL DEMOLITION IN AREAS OF RENOVATION. ALL WIRING DEVICES, LIGHT FIXTURES, WIRE, AND CONDUIT THAT ARE TO BE REMOVED SHALL BE STORED, AS DIRECTED BY THE OWNER, OR RELOCATED AS SHOWN ON THE NEW FLOOR PLANS.
- APPROPRIATE MEASURES SHALL BE TAKEN TO ASSURE CONTINUITY OF EXISTING CIRCUITS WHERE REQUIRED AND ALL RESULTING OUTAGES SHALL BE COORDINATED WITH THE OWNER PRIOR TO THE WORK. SOME AREAS WILL REMAIN UN-RENOVATED.
- THE ELECTRICAL CONTRACTOR SHALL BE RESPONSIBLE FOR COORDINATING WITH OWNER WHEN REQUIRED TO TURN OFF AND LOCKOUT POWER TO EQUIPMENT THAT IS BEING DEMOLISHED AND/OR MODIFIED. ACCURATE RECORDS OF ALL FACILITY CHANGES SHALL BE DOCUMENTED AND FURNISHED TO OWNER AND ENGINEER OF RECORD.
- THE ELECTRICAL CONTRACTOR SHALL BE RESPONSIBLE FOR UPDATING SCHEDULES IN ALL ELECTRICAL PANELS THAT ARE AFFECTED BY THIS WORK. UPDATED SCHEDULES ARE TO BE TYPEWRITTEN.

GENERAL ELECTRICAL NOTES

- EACH CIRCUIT SHALL HAVE AN EQUIPMENT GROUNDING CONDUCTOR, AND MULTI-WIRE CIRCUITS OF DIFFERENT PHASES MAY SHARE EQUIPMENT GROUND CONDUCTOR. EQUIPMENT GROUND CONDUCTOR SIZE SHALL NOT BE LESS THAN #12 AWG OR AS INDICATED ON THE DRAWINGS.
- ALL CONDUCTORS #10 AND SMALLER SHALL BE SOLID COPPER, AND ALL CONDUCTORS #8 AND LARGER SHALL BE STRANDED COPPER USING BOLTED LUGS AT TERMINALS.
- MINIMUM CONDUIT SIZE SHALL BE 3/4" UNLESS OTHERWISE NOTED.
- ALL WIRING DEVICES SHALL BE INSTALLED PLUMB, SQUARE, AND TRUE, AND ALL DEVICES INSTALLED AT A SINGLE LOCATION SHALL BE ALIGNED.
- MINIMUM WIRE SIZE SHALL BE #12 AWG UNLESS OTHERWISE SPECIFIED.
- ALL WORK SHALL COMPLY WITH THE 2014 EDITION OF THE NATIONAL ELECTRICAL CODE.
- THE ELECTRICAL CONTRACTOR SHALL BE RESPONSIBLE FOR UPDATING SCHEDULES IN ALL ELECTRICAL PANELS THAT ARE AFFECTED BY THIS WORK. UPDATED SCHEDULES ARE TO BE TYPEWRITTEN.
- THE ELECTRICAL CONTRACTOR SHALL BE RESPONSIBLE FOR MARKING ALL SWITCHES, RECEPTACLES, AND FIXED EQUIPMENT WITH THE BRANCH CIRCUIT PANEL NAME AND NUMBER SERVING EACH DEVICE.
- ALL CONDUIT SHALL BE INSTALLED AS HIGH AS POSSIBLE (MOUNT TO BOTTOM OF STRUCTURE) TO AVOID CONFLICTS WITH DUCTWORK AND PIPING. THE ELECTRICAL CONTRACTOR SHALL COORDINATE INSTALLATION WITH THE MECHANICAL CONTRACTOR.
- THE CONTRACTOR SHALL COORDINATE WITH THE OWNER AS TO CONSTRUCTION SCHEDULING, SERVICE INTERRUPTIONS, AND ACCESS TO WORK AREAS A MINIMUM OF (3) DAYS PRIOR TO WORK.
- ALL CONDUITS IN FINISHED AREAS SHALL BE CONCEALED IN HUNG CEILINGS, CONCEALED IN FURRED WALLS, OR INSTALLED INTO EXISTING WALLS TO REMAIN.
- ON THREE PHASE, FOUR WIRE SYSTEMS, DO NOT USE A COMMON NEUTRAL FOR BRANCH CIRCUIT FEEDERS.
- IT IS THE RESPONSIBILITY OF THE ELECTRICAL CONTRACTOR TO COORDINATE WITH ALL TRADES PRIOR TO BIDDING AND CONSTRUCTION. A COMPLETE SET OF DRAWINGS SHOULD BE REVIEWED TO ADEQUATELY UNDERSTAND THE SCOPE OF WORK.
- THE ELECTRICAL CONTRACTOR IS RESPONSIBLE FOR WORK REQUIRED OUTSIDE THE PROJECT BOUNDARY TO ENSURE ADJACENT SERVICES REMAIN ENERGIZED DURING RENOVATIONS.
- THE CONTRACTOR SHALL BE RESPONSIBLE TO CLOSELY COORDINATE ROUGH-IN REQUIREMENTS AND MOUNTING HEIGHTS WITH OWNER'S VENDOR OF CHOICE FOR OWNER SUPPLIED SYSTEMS.
- THE CONTRACTOR SHALL BE RESPONSIBLE TO COORDINATE WITH OWNER PRIOR TO ANY REQUIRED CORE-DRILLING.
- EXISTING CONDITIONS IN KEYED NOTES DEFINED. CONTRACTOR TO CONFIRM THAT THE VISIBLE EXISTING RACEWAYS, CONDUCTORS, AND BOXES PERTAINING TO THE WORK, MEET THE MINIMAL NEC REQUIREMENTS. IF DEFICIENCIES EXIST, REPORT TO ENGINEER OF RECORD.

DRAFT

**PRELIMINARY
FOR REVIEW ONLY**

ENGINEER SEAL

**INITIAL MODERNIZATION SOLUTION
LOUISIANA STATE UNIVERSITY
LOUISIANA ENERGY PARTNERS
BATON ROUGE, LOUISIANA**

GENERAL DEMOLITION NOTES:

1. REFER TO GENERAL ELECTRICAL DEMOLITION NOTES, SHEET E000.
2. XXXX

KEYED DEMOLITION NOTES:

- 1 REMOVE CH-7 MV CONTROLLER.
- 2 REMOVE CH-2 MV CONTROLLER.
- 3 REMOVE CH-4 MV CONTROLLER.
- 4 REMOVE CH-3 MV CONTROLLER ON MEZZANINE ABOVE.
- 5 REMOVE CH-1 MV CONTROLLER.
- 6 REMOVE CH-5 MV CONTROLLER.
- 7 EXISTING OIL-FILLED SWITCH AND POT TRANSFORMERS TO BE REMOVED.
- 8 EXISTING OIL-FILLED SWITCHES AND POT TRANSFORMERS TO BE REMOVED.
- 9 EXISTING S&C SWITCH, UTILITY TRANSFORMER, POT TRANSFORMERS, AND ASSOCIATED DISCONNECTS TO BE REMOVED.
- 10 EXISTING OIL-FILLED SWITCHES TO BE REMOVED.
- 11 EXISTING POT TRANSFORMERS AND ASSOCIATED DISCONNECTS TO BE REMOVED.
- 12 EXISTING WALL TO BE REMOVED. ALL EXISTING STARTER/DISCONNECTS TO BE RELOCATED TO NEW WALL LOCATION.
- 13 EXISTING CABLE TRAY TO BE REMOVED.

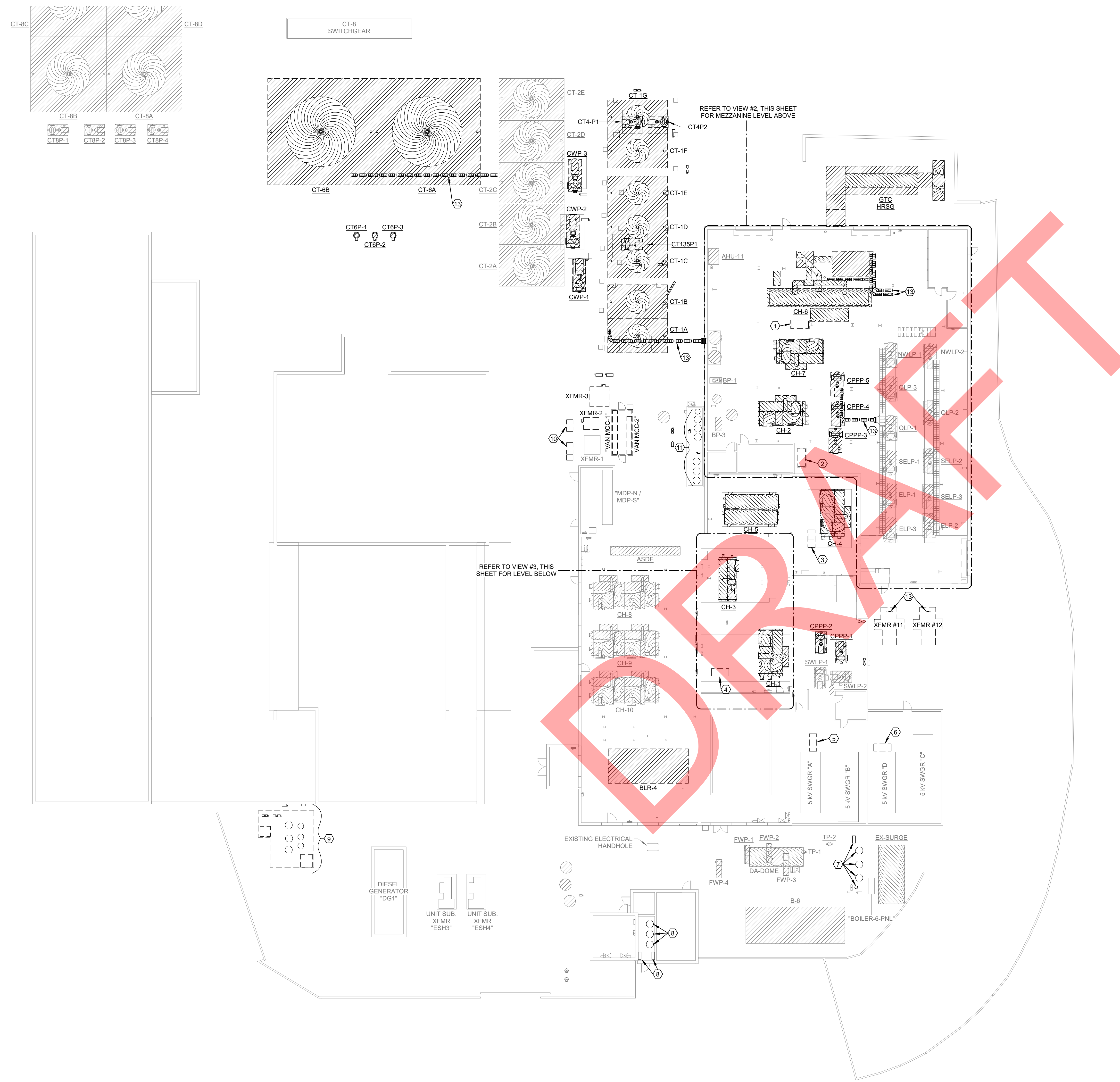

1 MAIN PLANT - OVERALL FLOOR PLAN - ELECTRICAL DEMOLITION
1/16" = 1'-0"

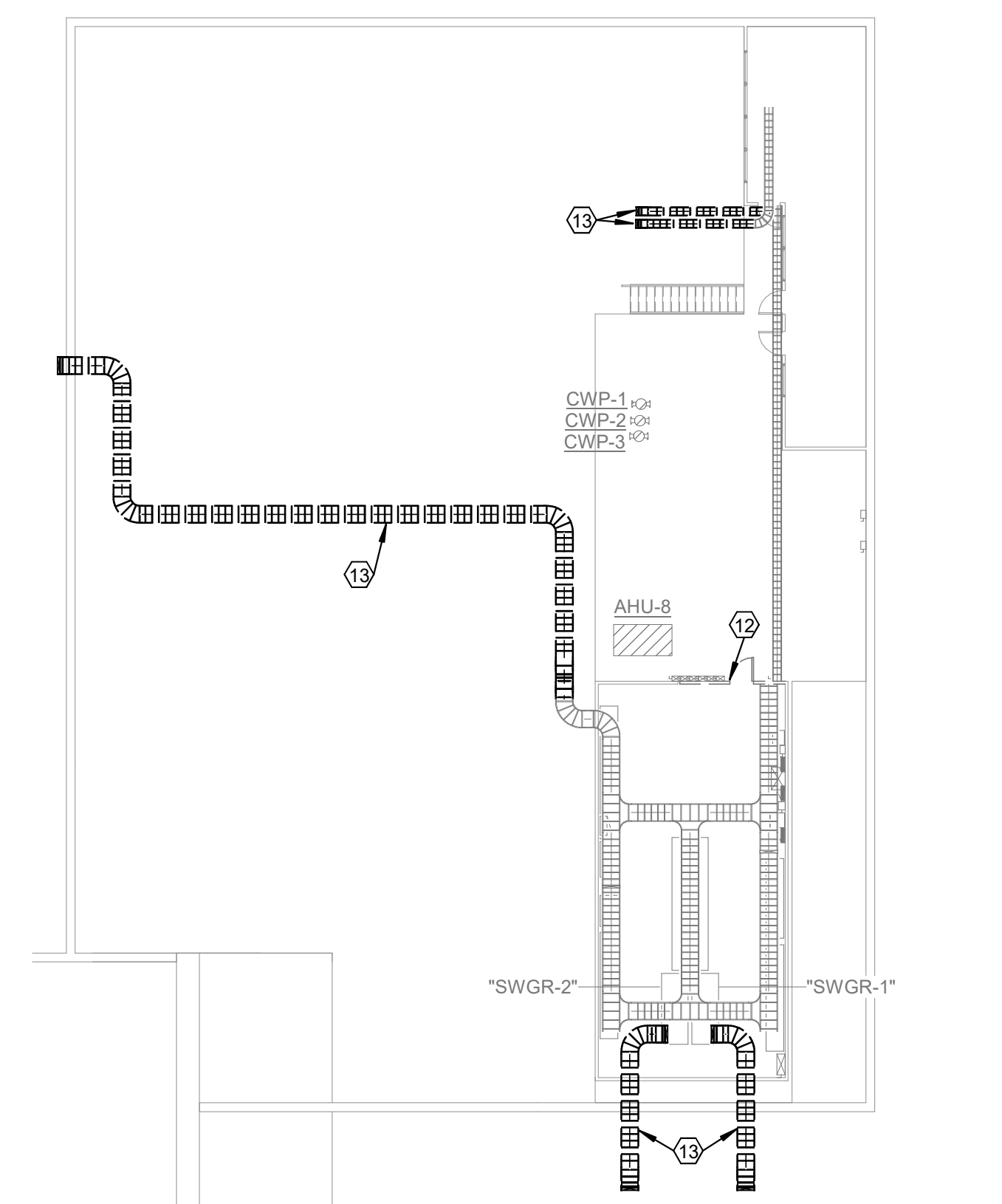

2 MAIN PLANT - OVERALL FLOOR PLAN - ELECTRICAL DEMOLITION
1/16" = 1'-0"

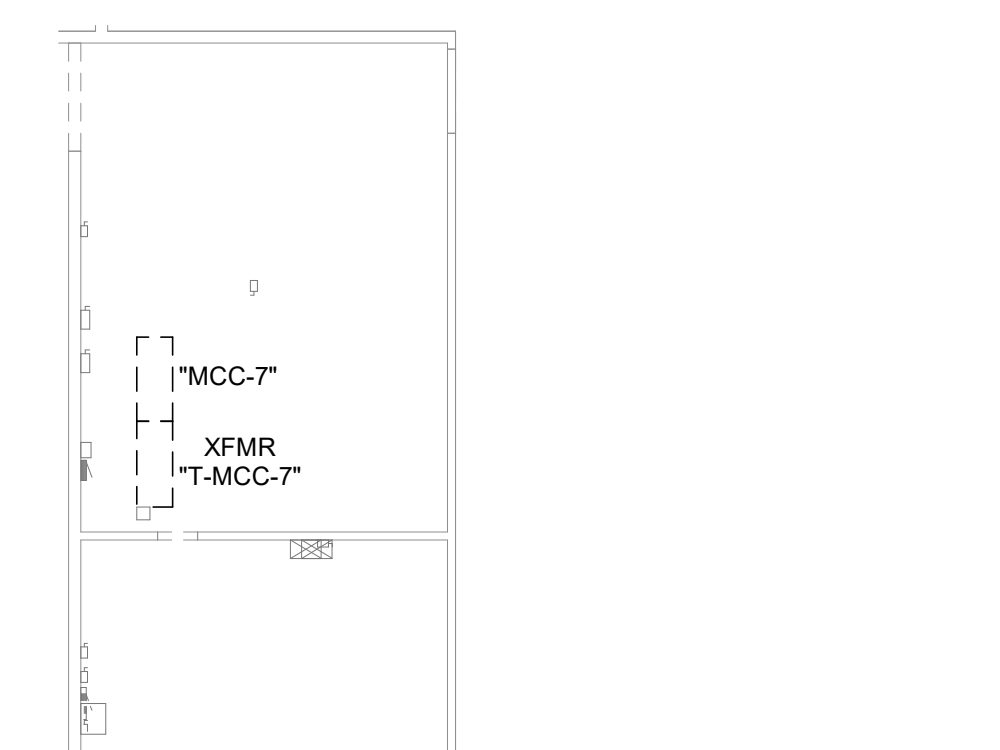

3 MAIN PLANT - OVERALL FLOOR PLAN - ELECTRICAL DEMOLITION
1/16" = 1'-0"

MARK	DATE	DESCRIPTION
ISSUE DATE:	09/17/21	
PROJECT NUMBER:	70-19-0025	
SHEET TITLE:		
MAIN PLANT - OVERALL FLOOR PLAN - ELECTRICAL DEMOLITION		

SHEET NUMBER:
E110

**PRELIMINARY
FOR REVIEW ONLY**

ENGINEER SEAL

**INITIAL MODERNIZATION SOLUTION
LOUISIANA STATE UNIVERSITY
LOUISIANA ENERGY PARTNERS
BATON ROUGE, LOUISIANA**

GENERAL NOTES:

1. REFER TO GENERAL ELECTRICAL NOTES, SHEET E000.
2. XXXX

KEYED NOTES:

1. NEW 3000 kVA, 4160V PRL / 480Y/277V SEC. UTILITY TRANSFORMER SERVING NEW MAIN-TIE-MAIN SWITCHBOARD (VIEW #2, THIS SHEET).
2. NEW 150 kVA, 4160V PRL / 208Y/120V SEC. UTILITY TRANSFORMER AND NEW 400A, 208Y/120V BRANCH PANEL FOR RECONNECTION OF EXISTING SEWER PUMPS.
3. NEW 300 kVA, 4160V PRL / 208Y/120V SEC. UTILITY TRANSFORMER AND NEW 1200A, 208Y/120V DISTRIBUTION PANEL FOR RECONNECTION OF EXISTING AUDUBON SUGAR AND OLD CHEMICAL ENGINEERING BUILDING POWER.
4. NEW 600A, 480Y/277V DISTRIBUTION PANEL FOR RECONNECTION OF EXISTING LOADS REMAINING AFTER DEMOLITION OF "MCC-7".
5. EXTEND WALL OUT TO ACCOMMODATE NEW MAIN-TIE-MAIN SWITCHBOARD.

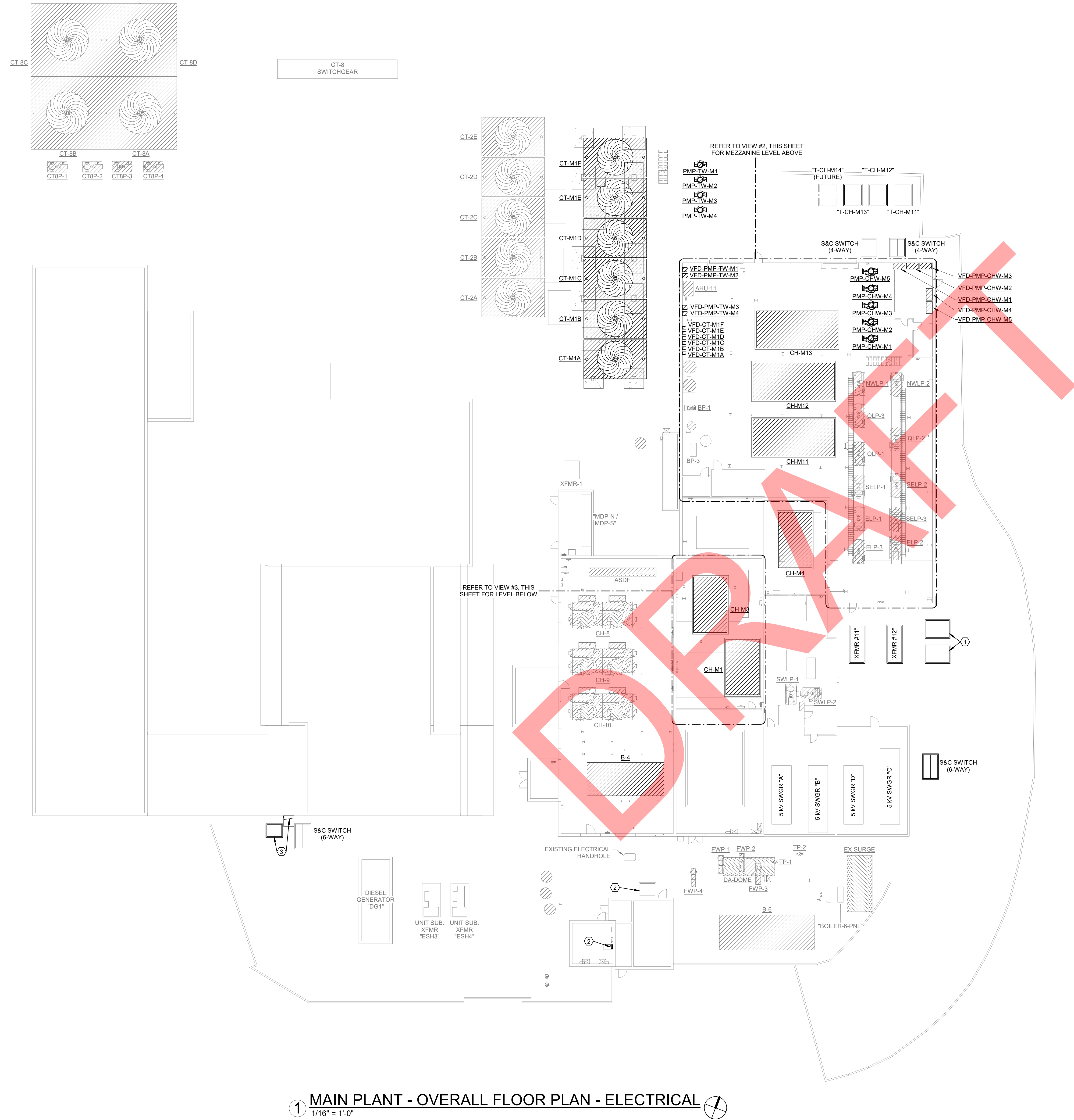

1 MAIN PLANT - OVERALL FLOOR PLAN - ELECTRICAL
1/16" = 1'-0"

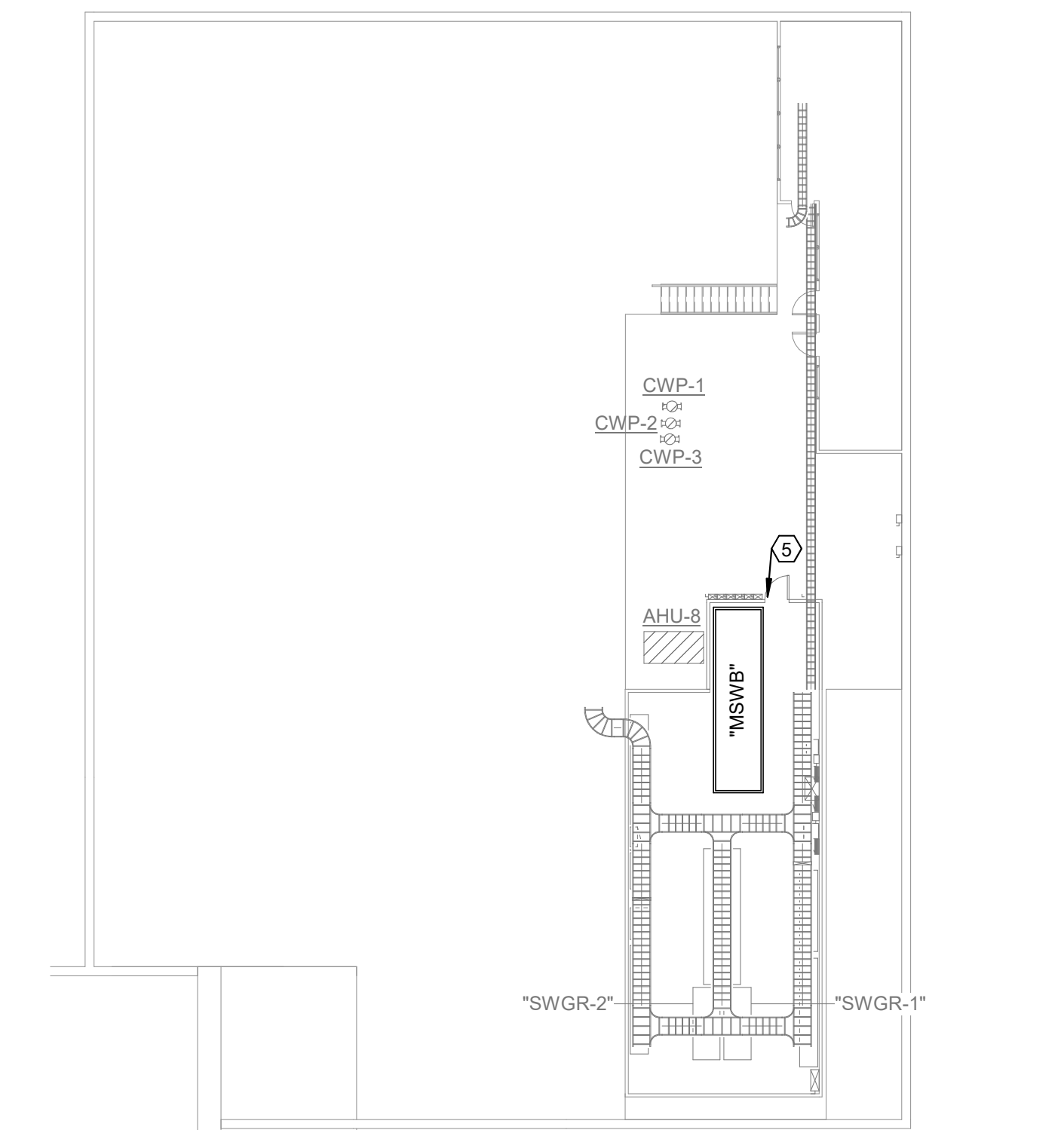

2 MAIN PLANT - OVERALL FLOOR PLAN - ELECTRICAL
1/16" = 1'-0"

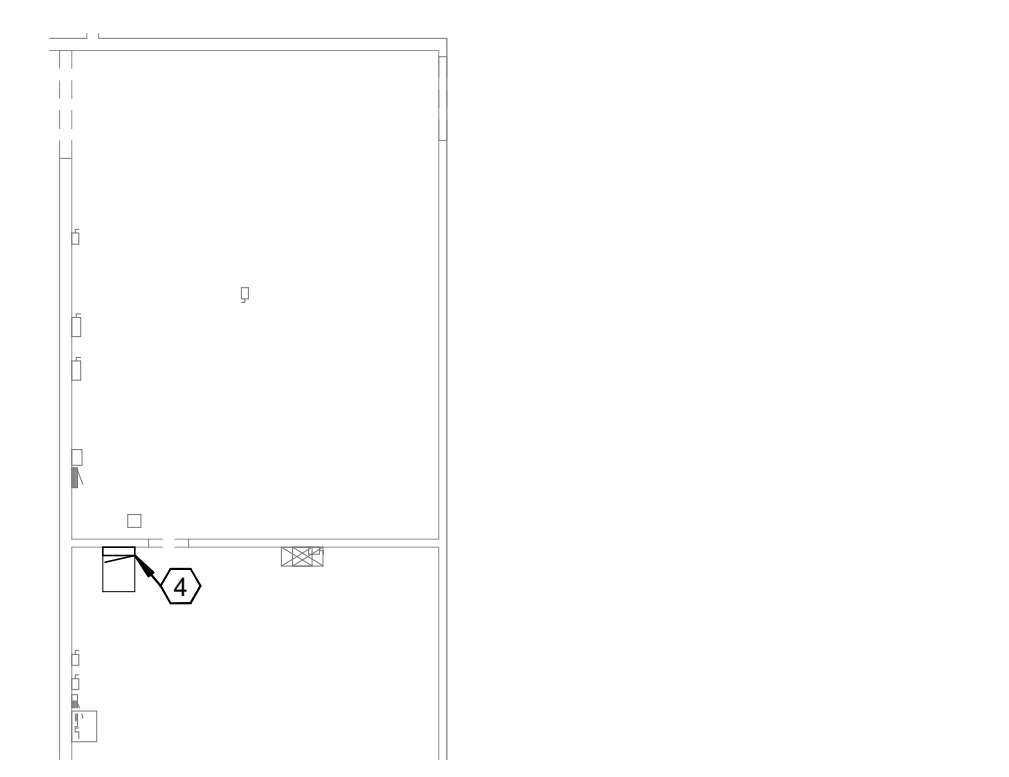

3 MAIN PLANT - OVERALL FLOOR PLAN - ELECTRICAL
1/16" = 1'-0"

MARK	DATE	DESCRIPTION
ISSUE DATE:	09/17/21	
PROJECT NUMBER:	70-19-0025	
SHEET TITLE:		
MAIN PLANT - OVERALL FLOOR PLAN - ELECTRICAL		
SHEET NUMBER:		
E120		

**PRELIMINARY
FOR REVIEW ONLY**

ENGINEER SEAL

**INITIAL MODERNIZATION SOLUTION
LOUISIANA STATE UNIVERSITY
LOUISIANA ENERGY PARTNERS
BATON ROUGE, LOUISIANA**

GENERAL DEMOLITION NOTES:

1. REFER TO GENERAL ELECTRICAL DEMOLITION NOTES, SHEET E000.
2. XXXX

KEYED DEMOLITION NOTES:

1. XXXX

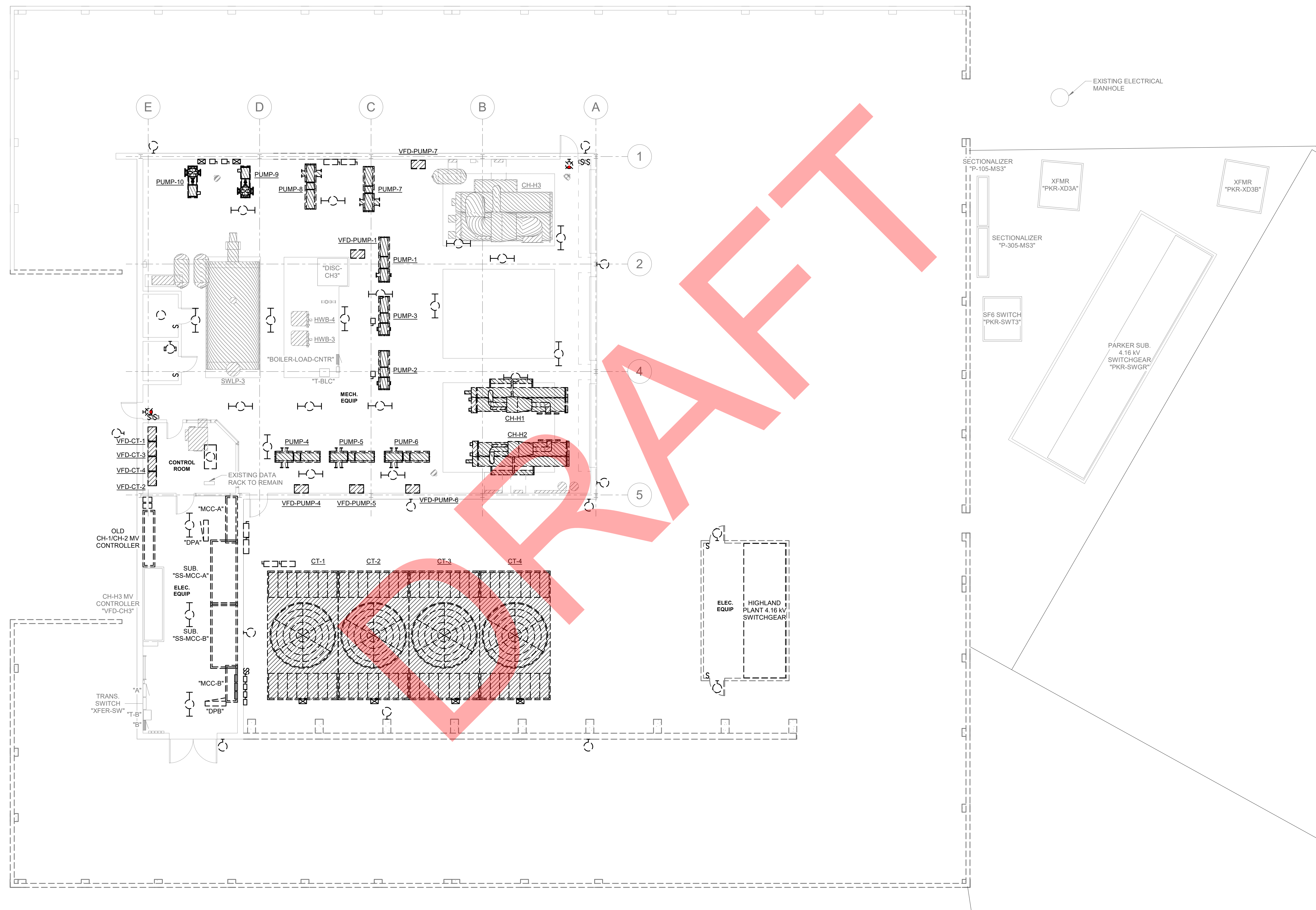

1 HIGHLAND PLANT - FLOOR PLAN - ELECTRICAL DEMOLITION
1/8" = 1'-0"

MARK	DATE	DESCRIPTION
ISSUE DATE:	09/17/21	
PROJECT NUMBER:	70-19-0025	
SHEET TITLE:		
HIGHLAND PLANT - FLOOR PLAN - ELECTRICAL DEMOLITION		
SHEET NUMBER:		
E310		

**PRELIMINARY
FOR REVIEW ONLY**

ENGINEER SEAL

**INITIAL MODERNIZATION SOLUTION
LOUISIANA STATE UNIVERSITY
LOUISIANA ENERGY PARTNERS
BATON ROUGE, LOUISIANA**

GENERAL NOTES:

1. REFER TO GENERAL ELECTRICAL NOTES, SHEET E000.
2. NEW LIGHTING AND CONTROLS TO BE PROVIDED FOR EXISTING BUILDING, NEW PORTION OF BUILDING, AND SITE.

KEYED NOTES:

1. PROVIDE CONCRETE BOLLARDS AROUND NEW SITE ELECTRICAL EQUIPMENT AS REQUIRED.



1 HIGHLAND PLANT - FLOOR PLAN - ELECTRICAL
1/8" = 1'-0"

MARK	DATE	DESCRIPTION
ISSUE DATE:	09/17/21	
PROJECT NUMBER:	70-19-0025	
SHEET TITLE:		
HIGHLAND PLANT - FLOOR PLAN - ELECTRICAL		
SHEET NUMBER:		
E320		

**PRELIMINARY
 FOR REVIEW ONLY**

ENGINEER SEAL

**INITIAL MODERNIZATION SOLUTION
 LOUISIANA STATE UNIVERSITY
 LOUISIANA ENERGY PARTNERS
 BATON ROUGE, LOUISIANA**

MARK	DATE	DESCRIPTION

ISSUE DATE: 09/17/21

PROJECT NUMBER: 70-19-0025

SHEET TITLE:
 HIGHLAND PLANT - PDC
 SUBSTATION PLAN -
 ELECTRICAL

SHEET NUMBER:

E321

GENERAL NOTES:

- REFER TO GENERAL ELECTRICAL NOTES, SHEET E000.
- XXXX

KEYED NOTES:

① XXXX

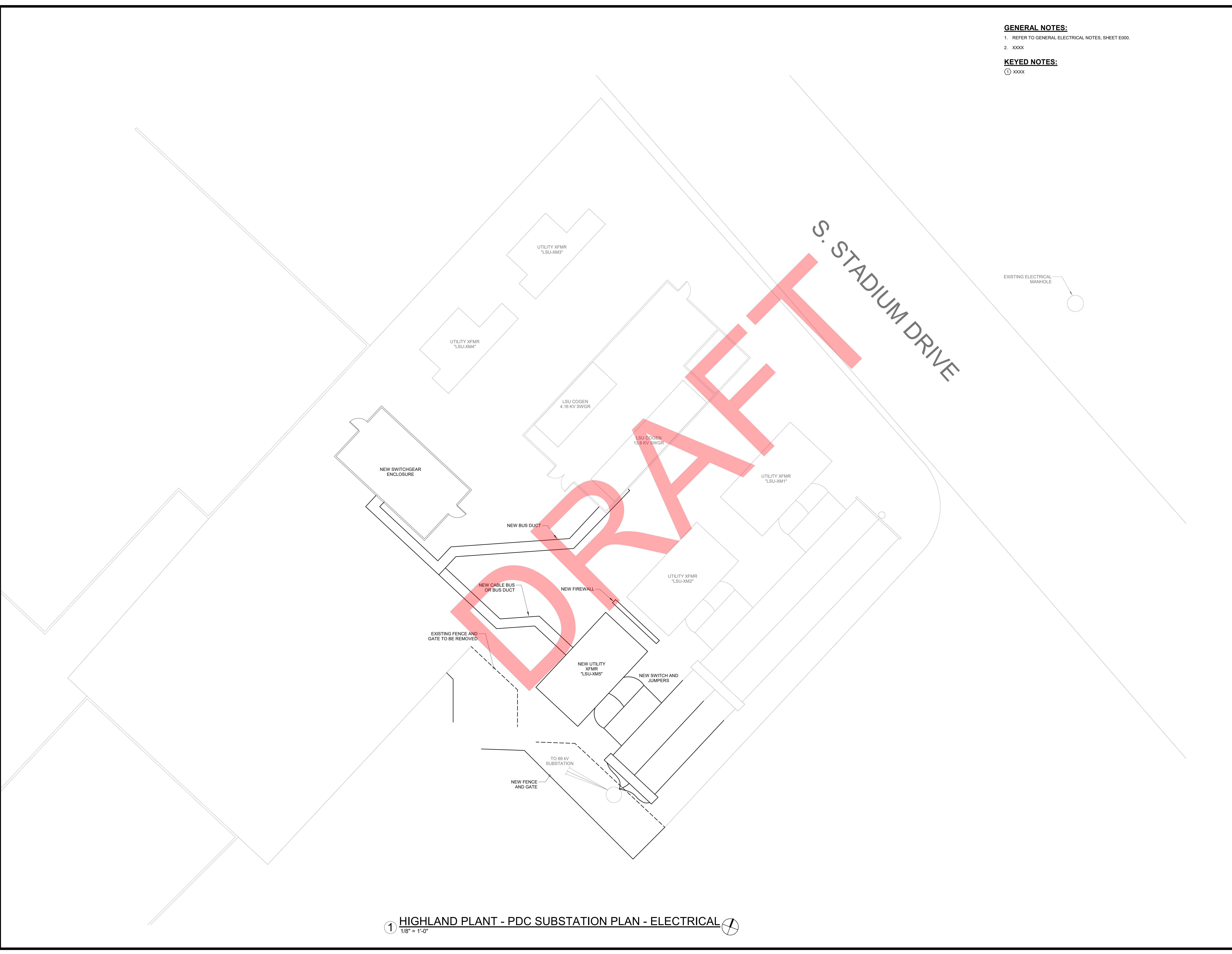

① **HIGHLAND PLANT - PDC SUBSTATION PLAN - ELECTRICAL**

1/8" = 1'-0"

**PRELIMINARY
FOR REVIEW ONLY**

ENGINEER SEAL

**INITIAL MODERNIZATION SOLUTION
LOUISIANA STATE UNIVERSITY
LOUISIANA ENERGY PARTNERS**
BATON ROUGE, LOUISIANA

MAIN PLANT ONE-LINE LEGEND	
SYMBOL	DESCRIPTION
	DISTRIBUTION BUS
	TRANSFORMER - DELTA PRIMARY, GROUNDED WYE SECONDARY
	VARIABLE FREQUENCY DRIVE (VFD) WITH INTEGRAL DISCONNECT
	NON-FUSED DISCONNECT
	BREAKER
	DRAW-OUT MEDIUM-VOLTAGE BREAKER
	SECTIONALIZER WITH 800A DEAD-BREAKS - NUMBER OF DEAD-BREAKS INDICATED
	AUTOMATIC TRANSFER SWITCH (ATS)
	VARIABLE-FREQUENCY DRIVE
	MOTOR LOAD
	PANELBOARD
	MOTOR STARTER
	NON-FUSED DISCONNECT
	SURGE ARRESTORS
	CONNECTION TO GROUNDING ELECTRODE(S)
	FEEDER CONTINUATION ARROW
	EXISTING-TO-REMAIN
	DEMOLISH AND REMOVE

GENERAL NOTES

- POT TRANSFORMERS DEMOLISHED AND REMOVED SHALL BE PCB TESTED PER FEDERAL EPA REQUIREMENTS BEFORE DISPOSAL. ANY TRANSFORMERS CONTAINING PCB'S SHALL BE DISPOSED OF ACCORDINGLY PER FEDERAL EPA REQUIREMENTS.

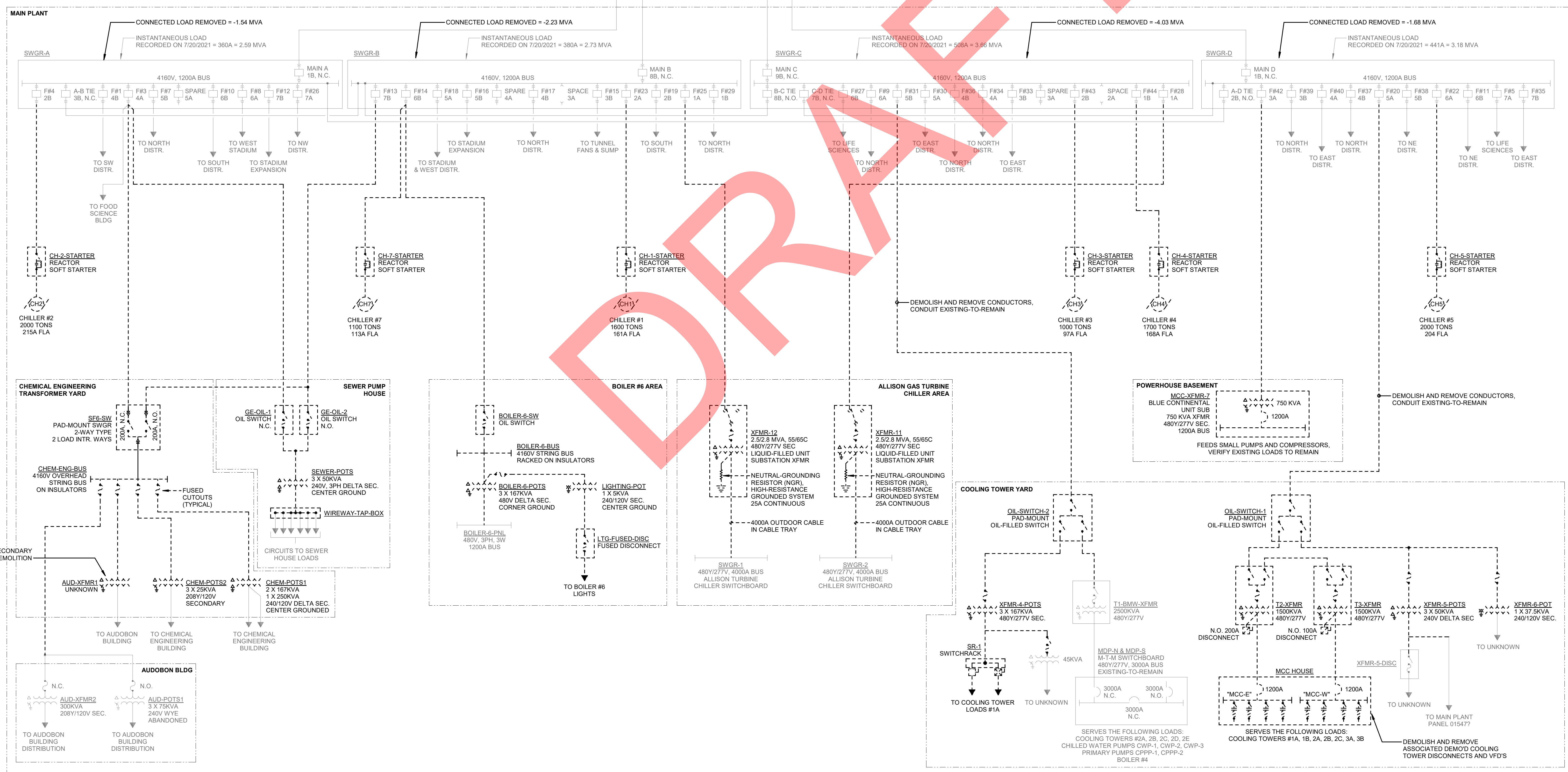
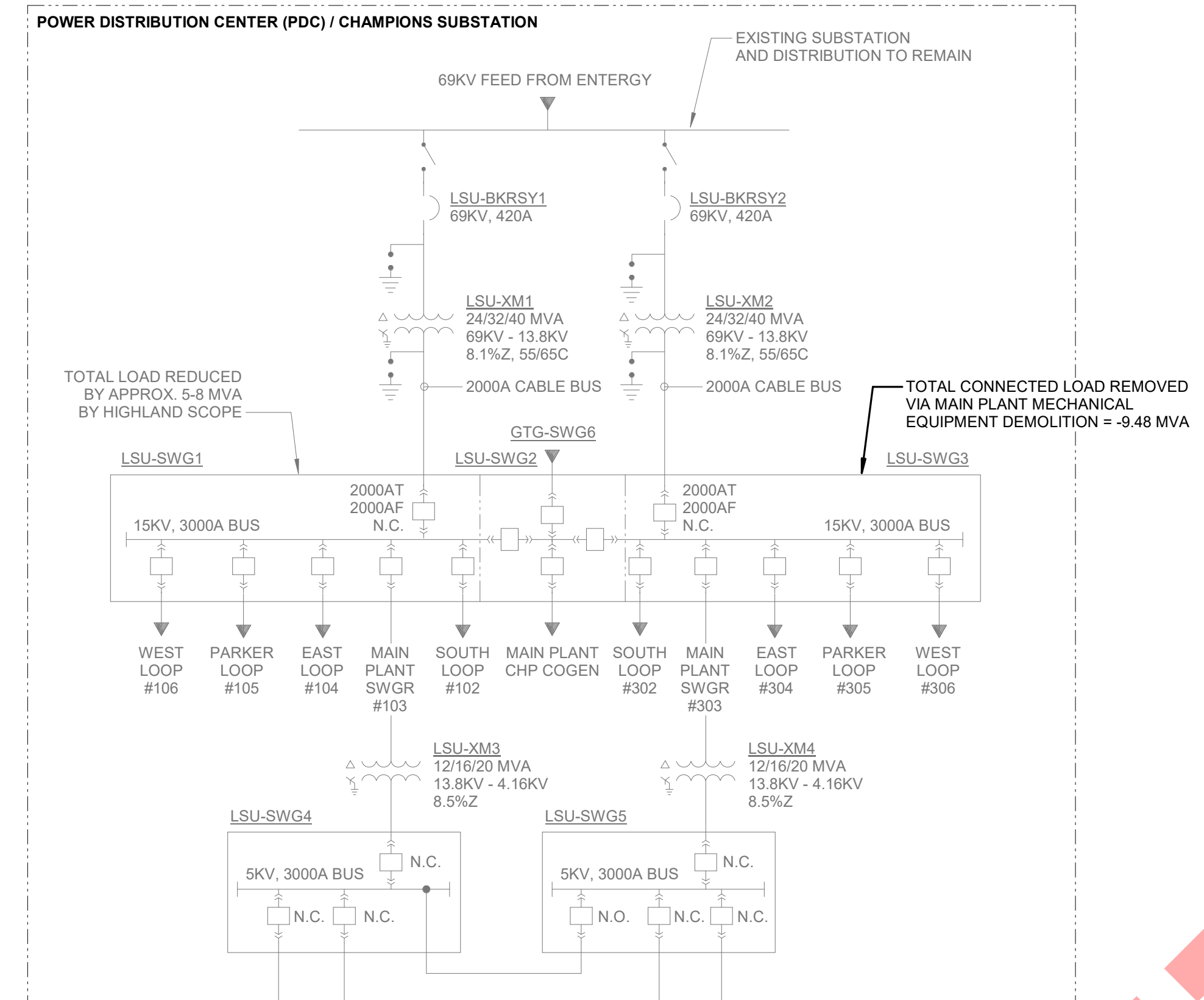

1 MAIN PLANT - ONE-LINE DIAGRAM - ELECTRICAL DEMOLITION
NOT TO SCALE

MARK	DATE	DESCRIPTION
ISSUE DATE:	09/17/21	
PROJECT NUMBER:	70-19-0025	
SHEET TITLE: MAIN PLANT - ONE-LINE DIAGRAM - ELECTRICAL DEMOLITION		
SHEET NUMBER: E400		

**PRELIMINARY
FOR REVIEW ONLY**

ENGINEER SEAL

**INITIAL MODERNIZATION SOLUTION
LOUISIANA STATE UNIVERSITY
LOUISIANA ENERGY PARTNERS
BATON ROUGE, LOUISIANA**

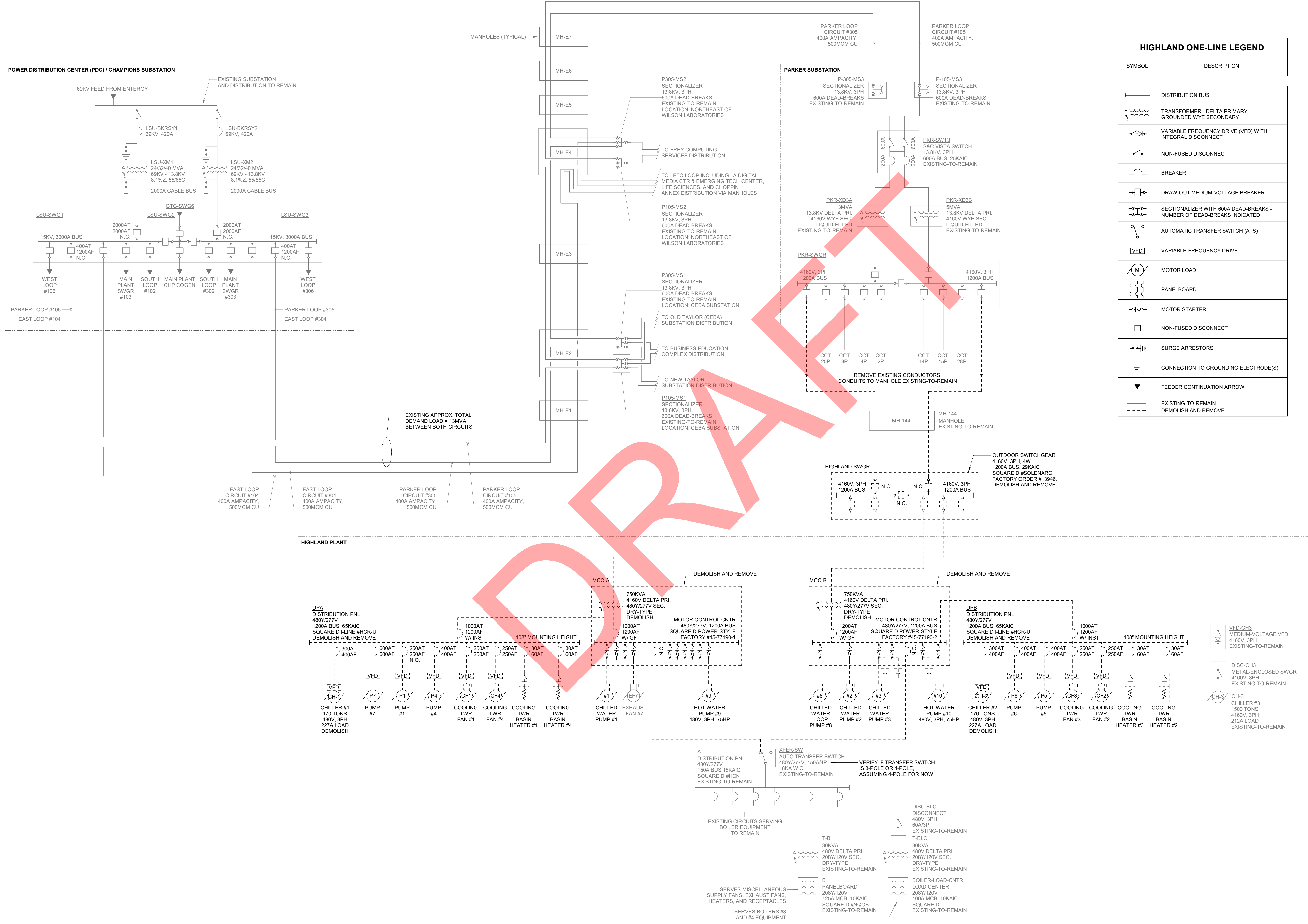

HIGHLAND PLANT - ONE-LINE DIAGRAM - ELECTRICAL DEMOLITION

NOT TO SCALE

MARK	DATE	DESCRIPTION
ISSUE DATE:	09/17/21	
PROJECT NUMBER:	70-19-0025	
SHEET TITLE:		
HIGHLAND PLANT - ONE-LINE DIAGRAM - ELECTRICAL DEMOLITION		
SHEET NUMBER:		
E410		

PRELIMINARY FOR REVIEW ONLY

ENGINEER SEAL

INITIAL MODERNIZATION SOLUTION
LOUISIANA STATE UNIVERSITY
LOUISIANA ENERGY PARTNERS
BATON ROUGE, LOUISIANA

MARK	DATE	DESCRIPTION
ISSUE DATE:	09/17/21	
PROJECT NUMBER:	70-19-0025	
SHEET TITLE:		
MAIN PLANT - ONE-LINE DIAGRAM - ELECTRICAL		
SHEET NUMBER:		
E420		

MAIN PLANT MV FEEDER SCHEDULE

MV FEEDER OVAL NOTE	CONDUCTORS AND CONDUIT	FEEDER SIZE
MV30	(5KV RATED, MV105, 133% INSULATION, EPR, COPPER W/ TAPE SHIELD) 3-#6, #6G, 2" C	30A/3P, 5KV
MV200	(5KV RATED, MV105, 133% INSULATION, EPR, COPPER W/ TAPE SHIELD) 3-#10, #6G, 3" C	200A/3P, 5KV
MV225	(5KV RATED, MV105, 133% INSULATION, EPR, COPPER W/ TAPE SHIELD) 3-#10, #6G, 3" C	225A/3P, 5KV
MV300	(5KV RATED, MV105, 133% INSULATION, EPR, COPPER W/ TAPE SHIELD) 3-#4/0, #4G, 3" C	300A/3P, 5KV
MV350	(5KV RATED, MV105, 133% INSULATION, EPR, COPPER W/ TAPE SHIELD) 3-350 KCMIL, #2G, 4" C	350A/3P, 5KV
MV500	(5KV RATED, MV105, 133% INSULATION, EPR, COPPER W/ TAPE SHIELD) 3-500 KCMIL, #2G, 4" C	500A/3P, 5KV
MV600	(5KV RATED, MV105, 133% INSULATION, EPR, COPPER W/ TAPE SHIELD) (2 SETS) 3-#4/0, #4G, 3" C	600A/3P, 5KV

MAIN PLANT LV FEEDER SCHEDULE

MV FEEDER OVAL NOTE	CONDUCTORS AND CONDUIT	FEEDER SIZE
50A	(CU) 3-#8, #10G, 3/4" C	50A/3P
100A	(CU) 3-#2, #6G, 1 1/4" C	100A/3P
150A	(CU) 3-#10, #6G, 2" C	150A/3P
225A	(CU) 3-#4/0, #4G, 2 1/2" C	225A/3P
400A	(CU) (2 SETS) 4-#3/0, #3G, 2 1/2" C	400A/3P
500A	(CU) (2 SETS) 3-250 KCMIL, #2G, 2 1/2" C	500A/3P
1000A	(CU) (3 SETS) 3-400 KCMIL, #2G, 3" C	1000A/3P
1200A	(CU) (4 SETS) 3-350 KCMIL, #3G, 3" C	1200A/3P
1600A	(CU) (5 SETS) 3-400 KCMIL, #4G, 3" C	1600A/3P
4000A	(CU) (11 SETS) 4-500 KCMIL, 500 KCMIL G, 4" C	4000A/3P

PDC SUBSTATION EXPANSION SCOPE SHOWN ON HIGHLAND PLANT ONE-LINE DIAGRAM. PDC SUBSTATION EXISTING CONFIGURATION SHOWN FOR REFERENCE ONLY.

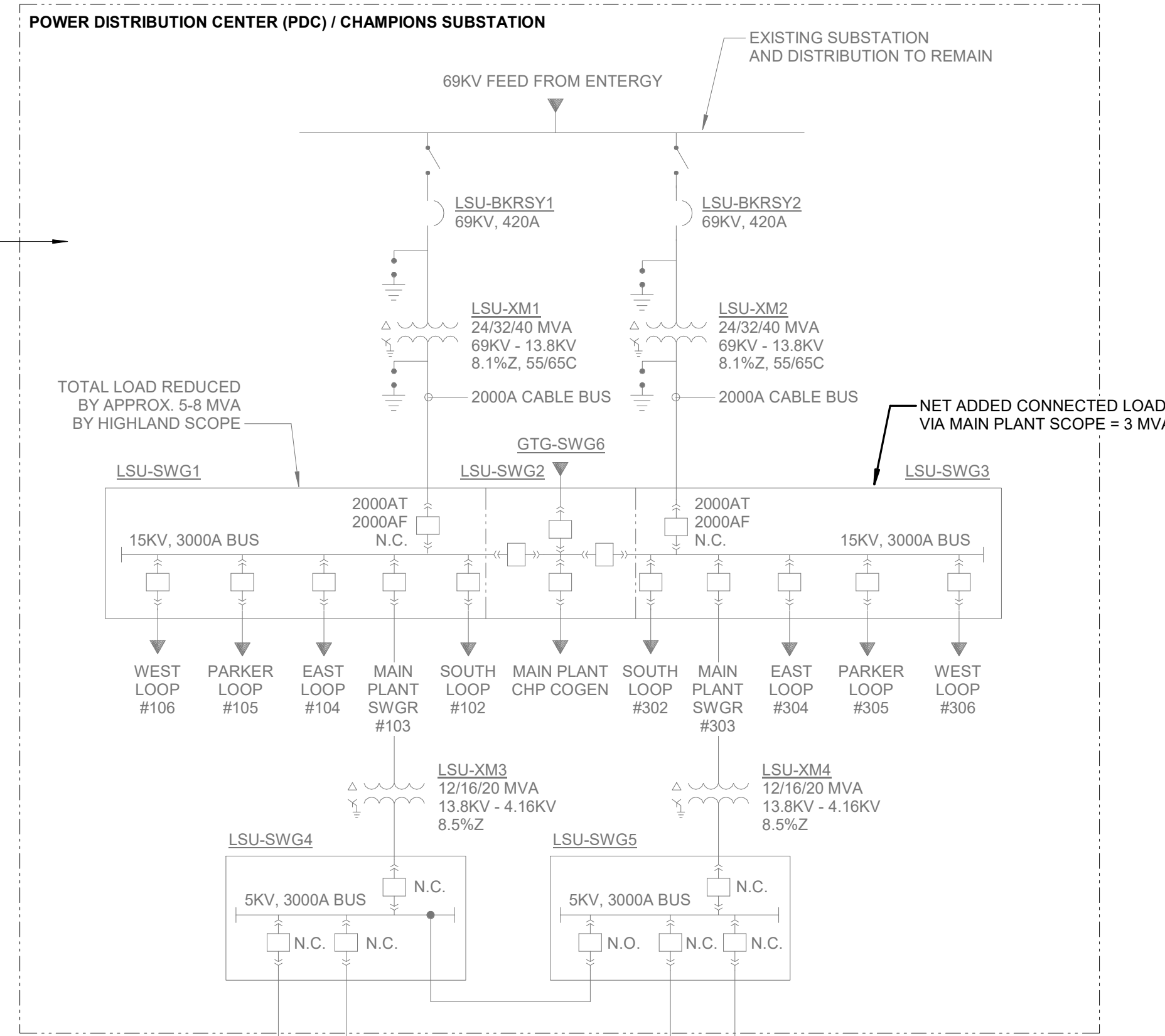

MAIN PLANT ONE-LINE LEGEND

SYMBOL	DESCRIPTION	SYMBOL	DESCRIPTION
(Oval)	FEEDER OVAL NOTE - REFER TO FEEDER SCHEDULE FOR SIZE	(SPD)	SURGE-PROTECTIVE DEVICE
(Horizontal line)	DISTRIBUTION BUS	(M)	MOTOR LOAD
(Wavy line)	TRANSFORMER - DELTA PRIMARY, GROUNDWYE SECONDARY	(Panel)	PANELBOARD
(Vertical line with gap)	FUSED DISCONNECT	(Box with X)	ENCLOSED COMBINATION MOTOR STARTER
(Vertical line with triangle)	VARIABLE FREQUENCY DRIVE (VFD) WITH INTEGRAL DISCONNECT	(Box with square)	NON-FUSED DISCONNECT
(Vertical line with circle)	VARIABLE FREQUENCY DRIVE (VFD) WITH INTEGRAL BREAKER	(Meter)	POWER METER WITH CURRENT TRANSFORMERS, BACNET CONNECTION
(Vertical line with AFE)	ACTIVE FRONT-END VARIABLE FREQUENCY DRIVE (VFD) WITH INTEGRAL BREAKER	(Key)	KEYED INTERLOCK PROVISIONS
(Vertical line with triangle)	NON-FUSED DISCONNECT	(Vertical line with bar)	SURGE ARRESTORS
(Vertical line with circle)	BREAKER	(Triangle)	CONNECTION TO GROUNDING ELECTRODE(S)
(Vertical line with square)	DRAW-OUT MEDIUM-VOLTAGE BREAKER	(Arrow)	FEEDER CONTINUATION ARROW
(Vertical line with circle)	SECTIONALIZER WITH 600A DEAD-BREAKS - NUMBER OF DEAD-BREAKS INDICATED	(LSI)	ADJUSTABLE LONG, SHORT, INSTANT TRIP
(Vertical line with circle)	EXISTING - EXISTING-TO-REMAIN	(N.O.)	NORMALLY OPEN
(Vertical line with circle)	NEW - INSTALL UNDER THIS PROJECT	(N.C.)	NORMALLY CLOSED
(Vertical line with circle)	FUTURE - INSTALLED UNDER FUTURE PROJECT	(Lock)	LOCKING ATTACHMENT

GENERAL NOTES:

- ALL MEDIUM-VOLTAGE UNDERGROUND FEEDERS SHALL BE CONCRETE-ENCASED, MINIMUM 3" OF CONCRETE COVERAGE AROUND DUCT BANKS, DYED RED THRU-OUT UNLESS DIRECTIONALLY BORED. IF BORED, USE SCHEDULE 80 HDPE.
- ALL MEDIUM-VOLTAGE UNDERGROUND FEEDER DUCT BANKS SHALL HAVE MINIMUM 25% SPARE CONDUITS (MINIMUM 1 SPARE OF EACH SIZE).
- ALL LOW-VOLTAGE AND MEDIUM-VOLTAGE CONDUCTORS SHALL BE COPPER. ALL TRANSFORMER COILS AND EQUIPMENT BUSING SHALL BE COPPER AND TIN-PLATED COPPER AT CONNECTIONS.
- ALL WIRE #6 AWG AND LARGER SHALL BE TERMINATED WITH COMPRESSION LUGS (NOT MECHANICAL LUGS).
- INTERIOR CONDUITS SHALL BE INSTALLED IN EMT CONDUIT WITH STEEL COMPRESSION FITTINGS. STUB-UPS FROM BELOW-GRADE TO ABOVE-GRADE SHALL BE GALVANIZED RIGID CONDUIT (GRG) ELBOWS.
- ALL CONDUITS LOCATED WITHIN 40FT OF COOLING TOWERS SHALL BE PVC-COATED GALVANIZED RIGID CONDUIT.
- FURNISH SHORT CIRCUIT, BREAKER COORDINATION, AND ARC FLASH STUDY FOR ALL NEW DISTRIBUTION EQUIPMENT SHOWN. THE COMPUTER PROGRAM SHALL USE ETAP. FURNISH ALL DATA FILES TO LSU AT PROJECT COMPLETION.
- WHERE INDICATED, MEDIUM-VOLTAGE PRIMARY TRANSFORMERS SHALL BE EQUIPPED WITH INTEGRAL ROTARY STRAIGHT-BLADE SECTIONALIZERS SWITCHES AND OIL-IMMERSED CURRENT LIMITING BAY-O-NET FUSES.
- VARIABLE FREQUENCY DRIVES PROVIDED BY MECHANICAL CONTROLS CONTRACTOR. INSTALLED BY ELECTRICAL CONTRACTOR.
- SUBMIT NAME AND LIST OF EXPERIENCE OF MEDIUM-VOLTAGE CABLE SPLICER PERSONNEL UTILIZED FOR THE PROJECT. USE 3M COLD-SHRINK SPLICE KITS. MINIMIZE NUMBER OF SPLICES REQUIRED.
- ALL 4160V PRIMARY WINDING TRANSFORMERS SHALL HAVE DUAL VOLTAGE PRIMARY WINDINGS WITH INTERCHANGEABLE TAPS FOR BOTH 4160V PRIMARY AND 13.8KV PRIMARY.
- LABELING OF EQUIPMENT SHALL CONFORM TO SPECIFICATIONS AND LSU DESIGN STANDARDS.

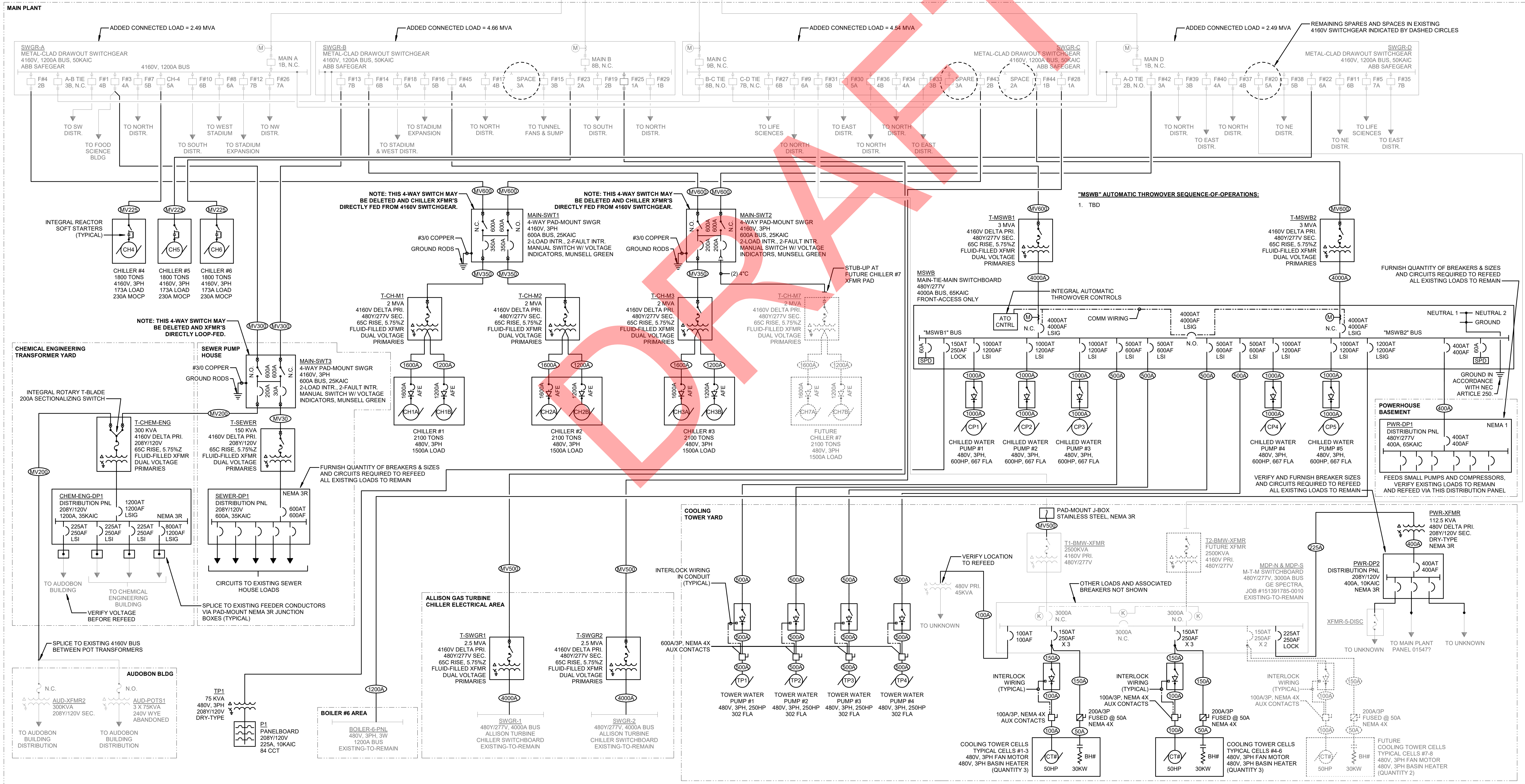

1 MAIN PLANT - ONE-LINE DIAGRAM - ELECTRICAL
NOT TO SCALE

SCHEDULE 15

KEY PERFORMANCE INDICATORS

The Concessionaire shall calculate whether any KPI Compensation for each Key Performance Indicator has been generated during a Fiscal Year in accordance with this Schedule 15. For the avoidance of doubt, each KPI Calculation corresponds to one Key Performance Indicator.

1. *Definitions*

- (a) Unless otherwise specified or the context otherwise requires, for the purposes of this Schedule 15, the following terms have the following meanings:
 - (i) “Availability KPIs” means those Key Performance Indicators which are measured by the following KPI Calculations: Plant Dispatch Events KPI Calculation, Steam Hours KPI Calculation, Steam Events KPI Calculation, Chilled Water Hours KPI Calculation, Chilled Water Events KPI Calculation, Cogeneration System Hours KPI Calculation.
 - (ii) “Electric Portion of the Utility System” means that portion of the Utility System exclusively used in the distribution of electricity to the University Campus to the line of demarcation for the Electric System as described in the Performance Standards.
 - (iii) “Emergency Response KPI” means the Key Performance Indicator measured by the Emergency Response KPI Calculation.
 - (iv) “Emergency Response Time” means the time, calculated in minutes and seconds, rounded to the nearest whole minute, between (i) the time which the Concessionaire has knowledge of or was notified about an Emergency that affected the Utility System or any portion thereof, including by visual observation of an Emergency, verbal or written notice from UMLLC or a third party or by an automated notification from the Utility system and (ii) the time the Concessionaire or the Operator had personnel at the source of the Emergency.
 - (v) “General Chilled Water Portion of the Utility System” means that portion of the Utility System exclusively used in the production and distribution of chilled water to the University Campus to the line of demarcation for the Chilled Water System as described in the Performance Standards.
 - (vi) “General Steam Portion of the Utility System” means that portion of the Utility System exclusively used in the production and distribution of steam to the University Campus, and the return of steam condensate, to the line of demarcation for the Steam System as described in the Performance Standards.
 - (vii) “KPI Calculation Appendix” means each of the appendices attached to this Schedule 15.

- (viii) “KPI Calculations” means, collectively, all Pre-Initial Modernization Solution Availability KPIs, all Pre-Initial Modernization Solution Operational KPIs, all Post-Initial Modernization Solution Availability KPIs, all Post-Initial Modernization Solution Operational KPIs, and Emergency Response KPI, and “KPI Calculation” shall mean any one of the foregoing.
 - (ix) “KPI Event” occurs when a KPI Calculation does not meet the Target for the applicable Key Performance Indicator in a Fiscal Year.
 - (x) “KPI Event Year” means a Fiscal Year in which a KPI Event occurs.
 - (xi) “KPI Measurement Window” means, commencing with the then-current Fiscal Year, the number of consecutive Fiscal Years preceding that Fiscal Year including the current Fiscal Year (but in no event more than the number of “Consecutive Event Years” shown on the applicable KPI Calculation Appendix) in which such KPI Event occurred.
 - (xii) “Operational KPIs” mean those Key Performance Indicators which are measured by the following KPI Calculations: Pre-Initial Modernization Plant Dispatch Optimal Sequence KPI Calculation, Post-Initial Modernization Plant Dispatch Optimal Sequence KPI Calculation, Cogeneration System Heat Rate KPI Calculation, Cogeneration System Output KPI Calculation, Standby Boiler Hours KPI Calculation, Hot Water System Efficiency KPI Calculation, Chiller Plant Efficiency KPI Calculation, Cooling Tower Cycles KPI Calculation.
 - (xiii) “Portion of the Utility System” means the General Chilled Water Portion of the Utility System, the Electric Portion of the Utility System, or the General Steam Portion of the Utility System, as applicable.
 - (xiv) “Target” for any Key Performance Indicator means the amount or percentage, as applicable, for that Key Performance Indicator as identified on the relevant KPI Calculation Appendix.
 - (xv) “Unplanned Outage” means the failure of steam or chilled water utilities infrastructure which had not been previously approved by UMLLC, where failure is defined as
 - (A) Steam: Any occurrence where steam header pressure (high pressure system) drops below 75 PSIG for more than 10 continuous minutes.
 - (B) Chilled Water: Any occurrence where plant discharge temperature is above 50 degrees for more than 15 continuous minutes, any occurrence where chilled water differential pressure is less than 50% of set point for more than 15 continuous minutes
- (b) All capitalized words, not otherwise defined herein, shall have the meaning set forth in this Agreement (including all other schedules thereto), and if, pursuant to the terms and conditions of the Agreement, the definition of such capitalized words is modified, such modification shall be deemed to apply in this Schedule 15.

(c) References to a “current Fiscal Year” herein shall mean the Fiscal Year for which the KPI Calculation is being determined.

2. Rules of General Applicability

- (a) If, in any instance, the KPI Compensation is shown by the applicable KPI Calculation Appendix to be \$3,000,000, it (and any cell in that KPI Calculation Appendix to the right or below such cell) shall be deemed to read, in all such instances, “the greater of (i) \$3,000,000 and (ii) 10% of the Utility Fee for that particular Fiscal Year.”
- (b) All amounts shown in the KPI Calculation Appendix shall be Adjusted for Inflation on the date that is the start of each Compensation Calculation Measuring Period other than the first such Compensation Calculation Measuring Period.

3. KPI Calculation for each Pre-Initial Modernization Solution Availability KPI

- (a) *KPI Calculation for Plant Dispatch – Unplanned Outage (Events): KPI Calculation Appendix F-1(a)*

The Key Performance Indicator for the number of events of Unplanned Outages for Plant Dispatch is determined on an annual basis in each Fiscal Year to equal the number of unique Unplanned Outages for Plant Dispatch of the Utilities Infrastructure or any portion thereof (the “Plant Dispatch Events KPI Calculation”).

4. Determination of KPI Compensation for each Pre-Initial Modernization Solution Availability KPI

- (a) The KPI Compensation for each Pre-Initial Modernization Availability KPI for a Fiscal Year is determined as follows:
- (i) If the applicable KPI Calculation meets the Target for that Availability KPI in that Fiscal Year, then the KPI Compensation for that Key Performance Indicator for that Fiscal Year is \$0;
- (ii) If (A) such Fiscal Year is a KPI Event Year for that Availability KPI and (B) the immediately preceding Fiscal Year was not a KPI Event Year for that Availability KPI, then the KPI Compensation shall be the amount shown on the applicable KPI Calculation Appendix for that KPI Calculation under the column labeled “0 Consecutive Event Years” and in the row where the column labeled “Annual Score” includes the KPI Calculation in the applicable KPI Calculation Appendix;
- (iii) If such Fiscal Year and the immediately preceding Fiscal Year are both KPI Event Years for that Availability KPI, then the KPI Compensation shall be determined by adding the applicable KPI Calculation for the Fiscal Years during the KPI Measurement Window and dividing that sum by the number of Fiscal Years in the KPI Measurement Window and rounding to the decimal point set forth in the applicable KPI Calculation, or if none is provided, to the nearest whole number, (the “KPI Calculation Average”), in which case the KPI Compensation shall be the amount shown on the applicable KPI Calculation Appendix for that KPI Calculation under the column where the number equals the number of Fiscal Years in the KPI Measurement Window and the row where the column labeled “Annual Score” includes the KPI Calculation Average in the applicable KPI Calculation Appendix, provided that if the KPI Compensation for such Fiscal Year would be higher if

calculated pursuant to sub-section (ii) hereof, then the KPI Compensation shall be calculated in accordance with sub-section (ii) as if the immediately preceding Fiscal Year was not a KPI Event Year.

The Concessionaire shall have the right, within 60 Days following an Unplanned Outage for a Portion of the Utility System, to deliver notice to UMLLC that it believes, in its reasonable discretion, that a single root cause caused an Unplanned Outage for multiple Portions of the Utility System, which notice shall include reasonable evidence supporting such conclusion. If UMLLC, in its reasonable discretion, agrees that a single root cause caused an Unplanned Outage for multiple Portions of the Utility System, then it shall waive the Unplanned Outages for all Portions of the Utility System other than the Portion of the Utility System that UMLLC, in its discretion, determines is the primary Portion of the Utility System affected by the root cause, solely for purposes of determining whether a KPI Event occurred in a particular Fiscal Year. For the avoidance of doubt, the Unplanned Outage for the primary Portion of the Utility System affected by the root cause shall be used to determine both the number of events of Unplanned Outages and the number of hours of Unplanned Outages for that Portion of the Utility System

5. *KPI Calculation for each Pre-Initial Modernization Solution Operational KPI*

(a) *KPI Calculation for Plant Dispatch – Optimal Sequence: KPI Calculation Appendix F-1(b)*

The Key Performance indicator for Plant Dispatch is determined on an annual basis by calculating the percent of time the plant was operating in Optimal Dispatch, where Optimal dispatch is defined as those hours where the overall sequence of the plant is providing the lowest hourly operational cost to LSU. LSU and CenTrio staff will meet on a monthly basis to review the detailed plant sequence of operation to determine which hours, if any, did not meet the Plant Dispatch – Optimal Sequence KPI (the “Pre-Initial Modernization Solution Plant Dispatch Optimal Sequence KPI Calculation”).

6. *Determination of KPI Compensation for each Pre-Initial Modernization Solution Operational KPI*

(a) The KPI Compensation for each Operational KPI for a Fiscal Year is determined as follows:

- (i) If the applicable KPI Calculation meets the Target for that Operational KPI in that Fiscal Year, then the KPI Compensation for that Key Performance Indicator for that Fiscal Year is \$0;
- (ii) If (A) such Fiscal Year is a KPI Event Year for that Operational KPI and (B) the immediately preceding Fiscal Year was not a KPI Event Year for that Operational KPI, then the KPI Compensation shall be the amount shown on the applicable KPI Calculation Appendix for that KPI Calculation under the column labeled “0 Consecutive Event Years” and in the row where the column labeled “Annual Score” includes the KPI Calculation in the applicable KPI Calculation Appendix;
- (iii) If such Fiscal Year and the immediately preceding Fiscal Year are both KPI Event Years for that Operational KPI, then the KPI Compensation shall be determined by determining the KPI Calculation Average, in which case the KPI Compensation shall be the amount shown on the applicable KPI Calculation Appendix for that KPI Calculation under the column where the

number equals the number of Fiscal Years in the KPI Measurement Window and the row where the column labeled “Annual Score” includes the KPI Calculation Average in the applicable KPI Calculation Appendix, provided that if the KPI Compensation for such Fiscal Year would be higher if calculated pursuant to sub-section (ii) hereof, then the KPI Compensation shall be calculated in accordance with sub-section (ii) as if the immediately preceding Fiscal Year was not a KPI Event Year.

7. KPI Calculation for each Post-Initial Modernization Solution Availability KPI

(a) *KPI Calculation for Steam – Unplanned Outage (Hours): KPI Calculation Appendix F-2(h)*

The Key Performance Indicator for the hours of Unplanned Outages for steam is determined on an annual basis in each Fiscal Year by dividing the number of hours that constitute an Unplanned Outage in that Fiscal Year for the Steam Portion of the Utilities Infrastructure by the total possible connection hours of the Steam Portion of the Utilities Infrastructure during that Fiscal Year, expressed as a percentage rounded to the nearest thousandth decimal point, and subtracting that result from 100% (the “Steam Hours KPI Calculation”).

(b) *KPI Calculation for Steam – Unplanned Outage (Events): KPI Calculation Appendix F-2(i)*

The Key Performance Indicator for the number of events of Unplanned Outages for steam is determined on an annual basis in each Fiscal Year equal the number of unique Unplanned Outages for the General Steam Portion of the Utilities Infrastructure (the “Steam Events KPI Calculation”).

(c) *KPI Calculation for Chilled Water – Unplanned Outage (Hours): KPI Calculation Appendix F-2(j)*

The Key Performance Indicator for the hours of Unplanned Outages for chilled water is determined on an annual basis in each Fiscal Year by dividing the number of hours that constitute an Unplanned Outage in that Fiscal Year for the Chilled Water Portion of the Utilities Infrastructure by the total possible connection hours of the Chilled Water Portion of the Utilities Infrastructure during that Fiscal Year, expressed as a percentage rounded to the nearest thousandth decimal point, and subtracting that result from 100% (the “Chilled Water Hours KPI Calculation”).

(d) *KPI Calculation for Chilled Water – Unplanned Outage (Events): KPI Calculation Appendix F-2(k)*

The Key Performance Indicator for the number of events of Unplanned Outages for chilled water is determined on an annual basis in each Fiscal Year to equal the number of unique Unplanned Outages for the Chilled Water Portion of the Utilities Infrastructure or any portion thereof (the “Chilled Water Events KPI Calculation”).

(e) *KPI Calculation for Cogeneration System– Unplanned Outage (Hours): KPI Calculation Appendix F-3*

The Key Performance Indicator for the hours of Unplanned Outages for the Cogeneration System is determined on an annual basis in each Fiscal Year by dividing the number of hours that constitute an Unplanned Outage in that Fiscal Year for the Cogeneration System Portion of the Utility System by the total possible connection hours of the Cogeneration System Portion of the Utility System during that Fiscal Year, expressed as a percentage rounded to the nearest thousandth decimal point, and subtracting that result from 100% (the “Cogeneration System Hours KPI Calculation”).

8. *Determination of KPI Compensation for each Post-Initial Modernization Solution Availability KPI*

- (a) The KPI Compensation for each Availability KPI for a Fiscal Year is determined as follows:
- (i) If the applicable KPI Calculation meets the Target for that Availability KPI in that Fiscal Year, then the KPI Compensation for that Key Performance Indicator for that Fiscal Year is \$0;
 - (ii) If (A) such Fiscal Year is a KPI Event Year for that Availability KPI and (B) the immediately preceding Fiscal Year was not a KPI Event Year for that Availability KPI, then the KPI Compensation shall be the amount shown on the applicable KPI Calculation Appendix for that KPI Calculation under the column labeled “0 Consecutive Event Years” and in the row where the column labeled “Annual Score” includes the KPI Calculation in the applicable KPI Calculation Appendix;
 - (iii) If such Fiscal Year and the immediately preceding Fiscal Year are both KPI Event Years for that Availability KPI, then the KPI Compensation shall be determined by adding the applicable KPI Calculation for the Fiscal Years during the KPI Measurement Window and dividing that sum by the number of Fiscal Years in the KPI Measurement Window and rounding to the decimal point set forth in the applicable KPI Calculation, or if none is provided, to the nearest whole number, (the “KPI Calculation Average”), in which case the KPI Compensation shall be the amount shown on the applicable KPI Calculation Appendix for that KPI Calculation under the column where the number equals the number of Fiscal Years in the KPI Measurement Window and the row where the column labeled “Annual Score” includes the KPI Calculation Average in the applicable KPI Calculation Appendix, provided that if the KPI Compensation for such Fiscal Year would be higher if calculated pursuant to sub-section (ii) hereof, then the KPI Compensation shall be calculated in accordance with sub-section (ii) as if the immediately preceding Fiscal Year was not a KPI Event Year.
- (b) The Concessionaire shall have the right, within 60 Days following an Unplanned Outage for a Portion of the Utility System, to deliver notice to UMLLC that it believes, in its reasonable discretion, that a single root cause caused an Unplanned Outage for multiple Portions of the Utility System, which notice shall include reasonable evidence supporting such conclusion. If UMLLC, in its reasonable discretion, agrees that a single root cause caused an Unplanned Outage for multiple Portions of the Utility System, then it shall waive the Unplanned Outages for all Portions of the Utility System other than the Portion of the Utility System that UMLLC, in its discretion, determines is the primary Portion of the Utility System affected by the root cause, solely for purposes of determining whether a KPI Event occurred in a particular Fiscal Year. For the avoidance of doubt, the Unplanned Outage for the primary Portion of the Utility System affected by the root cause shall be used to determine both the number of events of Unplanned Outages and the number of hours of Unplanned Outages for that Portion of the Utility System.

9. ***KPI Calculation for each Post-Initial Modernization Solution Operational KPI***

(a) *KPI Calculation for Plant Dispatch – Optimal Sequence: KPI Calculation Appendix F-2(a)*

The Key Performance indicator for Plant Dispatch is determined on an annual basis by calculating the percent of time the plant was operating in Optimal Dispatch, where Optimal dispatch is defined as those hours where the overall sequence of the plant is providing the lowest hourly operational cost to LSU. LSU and CenTrio staff will meet on a monthly basis to review the detailed plant sequence of operation to determine which hours, if any, did not meet the Plant Dispatch – Optimal Sequence KPI (the “Post-Initial Modernization Solution Plant Dispatch Optimal Sequence KPI Calculation”).

(b) *KPI Calculation for Plant Efficiency – Cogeneration System Heat Rate: KPI Calculation Appendix F-2(b)*

The Key Performance Indicator for the Cogeneration System Heat Rate is determined on an annual basis in each Fiscal Year by dividing the total British Thermal Units (“BTU”) consumed by the Cogeneration System by the total kilowatt hours (“kWh”) generated (the “Cogeneration System Heat Rate KPI Calculation”).

(c) *KPI Calculation for Plant Efficiency – Cogeneration System Output: KPI Calculation Appendix F-2(c)*

The Key Performance Indicator for the Cogeneration System Output is determined on an annual basis in each Fiscal Year by totalizing all output of the Cogenerations System measured in kWh divided by total run hours, defined as the total time that the generator output circuit breaker is closed (the “Cogeneration System Output KPI Calculation”).

(d) *KPI Calculation for Plant Efficiency – Standby Boiler Hours: KPI Calculation Appendix F-2(d)*

Standby boiler runs hours is defined as the total amount of annual hours the boiler runs to stay available for standby duty plus the total amount of run time the boiler operates when the cogeneration system is not on-line. (the “Standby Boiler Hours KPI Calculation”).

(e) *KPI Calculation for Plant Efficiency – Hot Water System Efficiency: KPI Calculation Appendix F-2(e)*

The Key Performance Indicator for the Hot Water System Efficiency is determined on an annual basis in each Fiscal Year by dividing fuel input (measured in MCF (defined as one thousand cubic feet of natural gas)) consumed by the Hot Water System by the total Million British Thermal Units (“MMBTU”) produced by the Hot Water System (the “Hot Water System Efficiency KPI Calculation”).

(f) *KPI Calculation for Plant Efficiency – Chiller Plant Efficiency: KPI Calculation Appendix F-2(f)*

The Key Performance Indicator for the Chiller Plant Efficiency is determined on an annual basis in each Fiscal Year by measuring the total kilowatt hours (“kWh”) consumed by the Chiller plant, including Chillers, Cooling Tower Fans, Colling Tower Pumps, and Chilled Water Pumps, divided by the total ton hours of chilled water produced (the “Chiller Plant Efficiency KPI Calculation”).

(g) *KPI Calculation for Plant Efficiency – Cooling Tower Cycles: KPI Calculation Appendix F-2(g)*

The Key Performance Indicator for the Cooling Tower Cycles is determined on an annual basis in each Fiscal Year comparing the level of solids of the recirculating cooling tower water to the level of solids in the makeup water (the “Cooling Tower Cycles KPI Calculation”).

10. *Determination of KPI Compensation for each Post-Initial Modernization Solution Operational KPI*

- (a) The KPI Compensation for each Operational KPI for a Fiscal Year is determined as follows:
- (i) If the applicable KPI Calculation meets the Target for that Operational KPI in that Fiscal Year, then the KPI Compensation for that Key Performance Indicator for that Fiscal Year is \$0;
 - (ii) If (A) such Fiscal Year is a KPI Event Year for that Operational KPI and (B) the immediately preceding Fiscal Year was not a KPI Event Year for that Operational KPI, then the KPI Compensation shall be the amount shown on the applicable KPI Calculation Appendix for that KPI Calculation under the column labeled “0 Consecutive Event Years” and in the row where the column labeled “Annual Score” includes the KPI Calculation in the applicable KPI Calculation Appendix;
 - (iii) If such Fiscal Year and the immediately preceding Fiscal Year are both KPI Event Years for that Operational KPI, then the KPI Compensation shall be determined by determining the KPI Calculation Average, in which case the KPI Compensation shall be the amount shown on the applicable KPI Calculation Appendix for that KPI Calculation under the column where the number equals the number of Fiscal Years in the KPI Measurement Window and the row where the column labeled “Annual Score” includes the KPI Calculation Average in the applicable KPI Calculation Appendix, provided that if the KPI Compensation for such Fiscal Year would be higher if calculated pursuant to sub-section (ii) hereof, then the KPI Compensation shall be calculated in accordance with sub-section (ii) as if the immediately preceding Fiscal Year was not a KPI Event Year.

11. *KPI Calculation for Emergency Response KPI*

(a) *KPI Calculation for Emergency Response – Emergency Response Time: KPI Calculation Appendix F-4*

The Key Performance Indicator for Emergency Response is determined on an annual basis in each Fiscal Year to equal the sum of the Emergency Response Scores for each Emergency during the applicable Fiscal Year (the “Emergency Response KPI Calculation”).

12. Determination of KPI Compensation for Emergency Response KPI

- (a) The KPI Compensation for Emergency Response KPI for a Fiscal Year is determined as follows:
 - (i) If the Emergency Response KPI Calculation in that Fiscal Year is at or below the Target for the Emergency Response KPI in that Fiscal Year, then the KPI Compensation for that Key Performance Indicator for that Fiscal Year is \$0;
 - (ii) If (A) such Fiscal Year is a KPI Event Year for that Emergency Response KPI and (B) the immediately preceding Fiscal Year was not a KPI Event Year for that Emergency Response KPI, then the KPI Compensation shall be the amount shown on the applicable KPI Calculation Appendix for that KPI Calculation under the column labeled “0 Consecutive Event Years” and in the row where the column labeled “Annual Score” includes the KPI Calculation in the applicable KPI Calculation Appendix;
- (b) Emergency Response Time Information
 - (i) Within 30 days after an Emergency, the Concessionaire shall provide UMLLC with written verification of the Emergency Response Time for the applicable Emergency, which shall include a description of the method by which the Concessionaire obtained the knowledge of, or the notice received by the Concessionaire for such Emergency, certified as true and accurate by a senior officer of the Operator, and the Concessionaire shall provide such additional information regarding such Emergency Response Time as reasonably requested by UMLLC.

13. Delivery of KPI Calculations and Right to Audit any Key Performance Indicator Calculation

- (a) Within 30 Days after the expiration of the current Fiscal Year, the Concessionaire shall provide UMLLC with written notice of its determination of all KPI Calculations and the KPI Compensation for the current Fiscal Year.
- (b) The records that the Concessionaire maintains with respect to the calculation of the actual KPI Calculations shall be retained by the Concessionaire for the Transaction Term in an electronic or other form reasonably acceptable to UMLLC. UMLLC shall have the right, to examine, copy and audit such records. All costs of any such audit shall be borne by UMLLC; provided, however, that if such audit establishes that any KPI Compensation for any particular KPI Calculation was lower than the final determination thereof, as set forth in the statement delivered by the Concessionaire to UMLLC, by at least 1.0%, then the Concessionaire shall pay the cost of such audit. If, as a result of such audit, it is determined that the Concessionaire under calculated the KPI Compensation for any particular Fiscal Year, such difference shall be included as KPI Compensation in the KPI Evaluation Period during which such determination was made.

KPI Calculation Appendix

DRAFT

F-1 (a) KPI Calculation for Plant Dispatch - Unplanned Outage (Events)

Annual Score Events	Utilities Fee Deduction		
	0 Consecutive Event Years	2 Consecutive Event Years	3 Consecutive Event Years
$0 \leq x \leq 5$	\$ -	\$ -	\$ -
$x = 6$	\$ 250,000	\$ 500,000	\$ 750,000
$x = 7$	\$ 500,000	\$ 750,000	\$ 1,000,000
$x = 8$	\$ 750,000	\$ 1,000,000	\$ 2,000,000
$x = 9$	\$ 1,000,000	\$ 2,000,000	\$ 2,500,000
$x = 10$	\$ 2,000,000	\$ 2,500,000	\$ 2,500,000
$x = 11$	\$ 2,500,000	\$ 2,500,000	\$ 2,500,000
$x = 12$	\$ 2,500,000	\$ 2,500,000	\$ 2,500,000
$x \geq 13$	\$ 2,500,000	\$ 2,500,000	\$ 2,500,000

Maximum Deduction: \$2,500,000
 Target: 5

DRAFT

F-1 (b) KPI Calculation for Plant Dispatch - Optimal Sequence

Annual Score % of Deployment	Utilities Fee Deduction		
	0 Consecutive Event Years	2 Consecutive Event Years	3 Consecutive Event Years
$x \geq 33.00\%$	\$ -	\$ -	\$ -
$33.000\% > x \geq 31.00\%$	\$ -	\$ -	\$ 250,000
$31.000\% > x \geq 29.00\%$	\$ -	\$ 250,000	\$ 500,000
$29.000\% > x \geq 27.00\%$	\$ 250,000	\$ 500,000	\$ 750,000
$27.000\% > x \geq 25.00\%$	\$ 500,000	\$ 750,000	\$ 1,000,000
$25.000\% > x \geq 23.00\%$	\$ 750,000	\$ 1,000,000	\$ 2,000,000
$23.000\% > x \geq 21.00\%$	\$ 1,000,000	\$ 2,000,000	\$ 2,500,000
$21.000\% > x \geq 19.00\%$	\$ 2,000,000	\$ 2,500,000	\$ 2,500,000
$x < 19.00\%$	\$ 2,500,000	\$ 2,500,000	\$ 2,500,000

Maximum Deduction: \$2,500,000
 Target: 33.00%

DRAFT

F-2 (a) KPI Calculation for Plant Dispatch - Optimal Sequence

Annual Score % of Optimal Sequence	Utilities Fee Deduction							
	0 Consecutive Event Years	2 Consecutive Event Years	3 Consecutive Event Years	4 Consecutive Event Years	5 Consecutive Event Years	6 Consecutive Event Years	7 Consecutive Event Years	8 Consecutive Event Years
100.000% ≥ x > 98.00%	\$ -	\$ -	\$ -	\$ -	\$ -	\$ -	\$ -	\$ -
98.000% ≥ x > 97.50%	\$ -	\$ -	\$ 250,000	\$ 500,000	\$ 750,000	\$ 1,000,000	\$ 2,000,000	\$ 2,500,000
97.500% ≥ x > 97.00%	\$ -	\$ 250,000	\$ 500,000	\$ 750,000	\$ 1,000,000	\$ 2,000,000	\$ 2,500,000	
97.000% ≥ x > 96.50%	\$ 250,000	\$ 500,000	\$ 750,000	\$ 1,000,000	\$ 2,000,000	\$ 2,500,000		
96.500% ≥ x > 96.00%	\$ 500,000	\$ 750,000	\$ 1,000,000	\$ 2,000,000	\$ 2,500,000			
96.000% ≥ x > 95.50%	\$ 750,000	\$ 1,000,000	\$ 2,000,000	\$ 2,500,000				
95.500% ≥ x > 95.00%	\$ 1,000,000	\$ 2,000,000	\$ 2,500,000					
95.000% ≥ x > 94.50%	\$ 2,000,000	\$ 2,500,000						
x < 94.50%	\$ 2,500,000							

Maximum Deduction: \$2,500,000
 Target: 98.00%

DRAFT

F-2 (b) KPI Calculation for Plant Efficiency - Cogeneration System Heat Rate

Annual Score BTU/kWh average	Utilities Fee Deduction							
	0 Consecutive Event Years	2 Consecutive Event Years	3 Consecutive Event Years	4 Consecutive Event Years	5 Consecutive Event Years	6 Consecutive Event Years	7 Consecutive Event Years	8 Consecutive Event Years
x ≤ 11,000	\$ -	\$ -	\$ -	\$ -	\$ -	\$ -	\$ -	\$ -
11,000 < x ≤ 11,250	\$ -	\$ -	\$ 250,000	\$ 500,000	\$ 750,000	\$ 1,000,000	\$ 2,000,000	\$ 2,500,000
11,250 < x ≤ 11,500	\$ -	\$ 250,000	\$ 500,000	\$ 750,000	\$ 1,000,000	\$ 2,000,000	\$ 2,500,000	
11,500 < x ≤ 11,750	\$ 250,000	\$ 500,000	\$ 750,000	\$ 1,000,000	\$ 2,000,000	\$ 2,500,000		
11,750 < x ≤ 12,000	\$ 500,000	\$ 750,000	\$ 1,000,000	\$ 2,000,000	\$ 2,500,000			
12,000 < x ≤ 12,250	\$ 750,000	\$ 1,000,000	\$ 2,000,000	\$ 2,500,000				
12,250 < x ≤ 12,500	\$ 1,000,000	\$ 2,000,000	\$ 2,500,000					
12,500 < x ≤ 12,750	\$ 2,000,000	\$ 2,500,000						
x > 12,750	\$ 2,500,000							

Maximum Deduction: \$2,500,000
 Target: 11,000

DRAFT

F-2 (c) KPI Calculation for Plant Efficiency - Cogeneration System Output

Annual Score kW total	Utilities Fee Deduction							
	0 Consecutive Event Years	2 Consecutive Event Years	3 Consecutive Event Years	4 Consecutive Event Years	5 Consecutive Event Years	6 Consecutive Event Years	7 Consecutive Event Years	8 Consecutive Event Years
x ≥ 20,000	\$ -	\$ -	\$ -	\$ -	\$ -	\$ -	\$ -	\$ -
20,000 > x ≥ 19,500	\$ -	\$ -	\$ 250,000	\$ 500,000	\$ 750,000	\$ 1,000,000	\$ 2,000,000	\$ 2,500,000
19,500 > x ≥ 19,000	\$ -	\$ 250,000	\$ 500,000	\$ 750,000	\$ 1,000,000	\$ 2,000,000	\$ 2,500,000	
19,000 > x ≥ 18,500	\$ 250,000	\$ 500,000	\$ 750,000	\$ 1,000,000	\$ 2,000,000	\$ 2,500,000		
18,500 > x ≥ 18,000	\$ 500,000	\$ 750,000	\$ 1,000,000	\$ 2,000,000	\$ 2,500,000			
18,000 > x ≥ 17,500	\$ 750,000	\$ 1,000,000	\$ 2,000,000	\$ 2,500,000				
17,500 > x ≥ 17,000	\$ 1,000,000	\$ 2,000,000	\$ 2,500,000					
17,000 > x ≥ 16,500	\$ 2,000,000	\$ 2,500,000						
x < 16,500	\$ 2,500,000							

Maximum Deduction: \$2,500,000
 Target: 20,000

DRAFT

F-2 (d) KPI Calculation for Plant Efficiency - Standby Boiler Hours

Annual Score Hours	Utilities Fee Deduction							
	0 Consecutive Event Years	2 Consecutive Event Years	3 Consecutive Event Years	4 Consecutive Event Years	5 Consecutive Event Years	6 Consecutive Event Years	7 Consecutive Event Years	8 Consecutive Event Years
x ≤ 666	\$ -	\$ -	\$ -	\$ -	\$ -	\$ -	\$ -	\$ -
666 < x ≤ 678	\$ -	\$ -	\$ 250,000	\$ 500,000	\$ 750,000	\$ 1,000,000	\$ 2,000,000	\$ 2,500,000
678 < x ≤ 690	\$ -	\$ 250,000	\$ 500,000	\$ 750,000	\$ 1,000,000	\$ 2,000,000	\$ 2,500,000	
690 < x ≤ 702	\$ 250,000	\$ 500,000	\$ 750,000	\$ 1,000,000	\$ 2,000,000	\$ 2,500,000		
702 < x ≤ 714	\$ 500,000	\$ 750,000	\$ 1,000,000	\$ 2,000,000	\$ 2,500,000			
714 < x ≤ 726	\$ 750,000	\$ 1,000,000	\$ 2,000,000	\$ 2,500,000				
726 < x ≤ 738	\$ 1,000,000	\$ 2,000,000	\$ 2,500,000					
738 < x ≤ 750	\$ 2,000,000	\$ 2,500,000						
x > 750	\$ 2,500,000							

Maximum Deduction: \$2,500,000
 Target: 666

DRAFT

F-2 (e) KPI Calculation for Plant Efficiency - Hot Water System Efficiency

Annual Score MCF/MMBTU average	Utilities Fee Deduction							
	0 Consecutive Event Years	2 Consecutive Event Years	3 Consecutive Event Years	4 Consecutive Event Years	5 Consecutive Event Years	6 Consecutive Event Years	7 Consecutive Event Years	8 Consecutive Event Years
x ≤ 1.240	\$ -	\$ -	\$ -	\$ -	\$ -	\$ -	\$ -	\$ -
1.240 < x ≤ 1.290	\$ -	\$ -	\$ 250,000	\$ 500,000	\$ 750,000	\$ 1,000,000	\$ 2,000,000	\$ 2,500,000
1.290 < x ≤ 1.340	\$ -	\$ 250,000	\$ 500,000	\$ 750,000	\$ 1,000,000	\$ 2,000,000	\$ 2,500,000	
1.340 < x ≤ 1.390	\$ 250,000	\$ 500,000	\$ 750,000	\$ 1,000,000	\$ 2,000,000	\$ 2,500,000		
1.390 < x ≤ 1.440	\$ 500,000	\$ 750,000	\$ 1,000,000	\$ 2,000,000	\$ 2,500,000			
1.440 < x ≤ 1.490	\$ 750,000	\$ 1,000,000	\$ 2,000,000	\$ 2,500,000				
1.490 < x ≤ 1.540	\$ 1,000,000	\$ 2,000,000	\$ 2,500,000					
1.540 < x ≤ 1.590	\$ 2,000,000	\$ 2,500,000						
x > 1.590	\$ 2,500,000							

Maximum Deduction: \$2,500,000
 Target: 1.24

DRAFT

F-2 (f) KPI Calculation for Plant Efficiency - Chiller Plant Efficiency

Annual Score kW/ton average	Utilities Fee Deduction							
	0 Consecutive Event Years	2 Consecutive Event Years	3 Consecutive Event Years	4 Consecutive Event Years	5 Consecutive Event Years	6 Consecutive Event Years	7 Consecutive Event Years	8 Consecutive Event Years
$x \leq 0.750$	\$ -	\$ -	\$ -	\$ -	\$ -	\$ -	\$ -	\$ -
$0.750 < x \leq 0.770$	\$ -	\$ -	\$ 250,000	\$ 500,000	\$ 750,000	\$ 1,000,000	\$ 2,000,000	\$ 2,500,000
$0.770 < x \leq 0.790$	\$ -	\$ 250,000	\$ 500,000	\$ 750,000	\$ 1,000,000	\$ 2,000,000	\$ 2,500,000	
$0.790 < x \leq 0.810$	\$ 250,000	\$ 500,000	\$ 750,000	\$ 1,000,000	\$ 2,000,000	\$ 2,500,000		
$0.810 < x \leq 0.830$	\$ 500,000	\$ 750,000	\$ 1,000,000	\$ 2,000,000	\$ 2,500,000			
$0.830 < x \leq 0.850$	\$ 750,000	\$ 1,000,000	\$ 2,000,000	\$ 2,500,000				
$0.850 < x \leq 0.870$	\$ 1,000,000	\$ 2,000,000	\$ 2,500,000					
$0.870 < x \leq 0.890$	\$ 2,000,000	\$ 2,500,000						
$x > 0.890$	\$ 2,500,000							

Maximum Deduction: \$2,500,000
 Target: 0.75

DRAFT

F-2 (g) KPI Calculation for Plant Efficiency - Cooling Tower Cycles

Annual Score Average Annual Cooling Tower Cycles of Concentration	Utilities Fee Deduction							
	0 Consecutive Event Years	2 Consecutive Event Years	3 Consecutive Event Years	4 Consecutive Event Years	5 Consecutive Event Years	6 Consecutive Event Years	7 Consecutive Event Years	8 Consecutive Event Years
$x \geq 12.5$	\$ -	\$ -	\$ -	\$ -	\$ -	\$ -	\$ -	\$ -
$12.5 > x \geq 11.5$	\$ -	\$ -	\$ 250,000	\$ 500,000	\$ 750,000	\$ 1,000,000	\$ 2,000,000	\$ 2,500,000
$11.5 > x \geq 10.5$	\$ -	\$ 250,000	\$ 500,000	\$ 750,000	\$ 1,000,000	\$ 2,000,000	\$ 2,500,000	
$10.5 > x \geq 9.5$	\$ 250,000	\$ 500,000	\$ 750,000	\$ 1,000,000	\$ 2,000,000	\$ 2,500,000		
$9.5 > x \geq 8.5$	\$ 500,000	\$ 750,000	\$ 1,000,000	\$ 2,000,000	\$ 2,500,000			
$8.5 > x \geq 7.5$	\$ 750,000	\$ 1,000,000	\$ 2,000,000	\$ 2,500,000				
$7.5 > x \geq 6.5$	\$ 1,000,000	\$ 2,000,000	\$ 2,500,000					
$6.5 > x \geq 5.5$	\$ 2,000,000	\$ 2,500,000						
$x < 5.5$	\$ 2,500,000							

Maximum Deduction: \$2,500,000
 Target: 12.5

DRAFT

F-2 (h) KPI Calculation for Steam - Unplanned Outage (Hours)

Annual Score % Availability	Utilities Fee Deduction							
	0 Consecutive Event Years	2 Consecutive Event Years	3 Consecutive Event Years	4 Consecutive Event Years	5 Consecutive Event Years	6 Consecutive Event Years	7 Consecutive Event Years	8 Consecutive Event Years
100.00% ≥ x > 99.75%	\$ -	\$ -	\$ -	\$ -	\$ -	\$ -	\$ -	\$ -
99.75% ≥ x > 99.70%	\$ -	\$ -	\$ 250,000	\$ 500,000	\$ 750,000	\$ 1,000,000	\$ 2,000,000	\$ 2,500,000
99.70% ≥ x > 99.65%	\$ -	\$ 250,000	\$ 500,000	\$ 750,000	\$ 1,000,000	\$ 2,000,000	\$ 2,500,000	
99.65% ≥ x > 99.60%	\$ 250,000	\$ 500,000	\$ 750,000	\$ 1,000,000	\$ 2,000,000	\$ 2,500,000		
99.60% ≥ x > 99.55%	\$ 500,000	\$ 750,000	\$ 1,000,000	\$ 2,000,000	\$ 2,500,000			
99.55% ≥ x > 99.50%	\$ 750,000	\$ 1,000,000	\$ 2,000,000	\$ 2,500,000				
99.50% ≥ x > 99.45%	\$ 1,000,000	\$ 2,000,000	\$ 2,500,000					
99.45% ≥ x > 99.40%	\$ 2,000,000	\$ 2,500,000						
x ≤ 99.40%	\$ 2,500,000							

Maximum Deduction: \$2,500,000

Target: 99.75%

DRAFT

F-2 (i) KPI Calculation for Steam - Unplanned Outage (Events)

Annual Score Events	Utilities Fee Deduction							
	0 Consecutive Event Years	2 Consecutive Event Years	3 Consecutive Event Years	4 Consecutive Event Years	5 Consecutive Event Years	6 Consecutive Event Years	7 Consecutive Event Years	8 Consecutive Event Years
x ≤ 4	\$ -	\$ -	\$ -	\$ -	\$ -	\$ -	\$ -	\$ -
x = 5	\$ -	\$ -	\$ 250,000	\$ 500,000	\$ 750,000	\$ 1,000,000	\$ 2,000,000	\$ 2,500,000
x = 6	\$ -	\$ 250,000	\$ 500,000	\$ 750,000	\$ 1,000,000	\$ 2,000,000	\$ 2,500,000	
x = 7	\$ 250,000	\$ 500,000	\$ 750,000	\$ 1,000,000	\$ 2,000,000	\$ 2,500,000		
x = 8	\$ 500,000	\$ 750,000	\$ 1,000,000	\$ 2,000,000	\$ 2,500,000			
x = 9	\$ 750,000	\$ 1,000,000	\$ 2,000,000	\$ 2,500,000				
x = 10	\$ 1,000,000	\$ 2,000,000	\$ 2,500,000					
x = 11	\$ 2,000,000	\$ 2,500,000						
x ≥ 12	\$ 2,500,000							

Maximum Deduction: \$2,500,000
 Target: 4

DRAFT

F-2 (j) KPI Calculation for Chilled Water - Unplanned Outage (Hours)

Annual Score % Availability	Utilities Fee Deduction							
	0 Consecutive Event Years	2 Consecutive Event Years	3 Consecutive Event Years	4 Consecutive Event Years	5 Consecutive Event Years	6 Consecutive Event Years	7 Consecutive Event Years	8 Consecutive Event Years
100.00% ≥ x > 99.90%	\$ -	\$ -	\$ -	\$ -	\$ -	\$ -	\$ -	\$ -
99.90% ≥ x > 99.85%	\$ -	\$ -	\$ 250,000	\$ 500,000	\$ 750,000	\$ 1,000,000	\$ 2,000,000	\$ 2,500,000
99.85% ≥ x > 99.80%	\$ -	\$ 250,000	\$ 500,000	\$ 750,000	\$ 1,000,000	\$ 2,000,000	\$ 2,500,000	
99.80% ≥ x > 99.75%	\$ 250,000	\$ 500,000	\$ 750,000	\$ 1,000,000	\$ 2,000,000	\$ 2,500,000		
99.75% ≥ x > 99.70%	\$ 500,000	\$ 750,000	\$ 1,000,000	\$ 2,000,000	\$ 2,500,000			
99.70% ≥ x > 99.65%	\$ 750,000	\$ 1,000,000	\$ 2,000,000	\$ 2,500,000				
99.65% ≥ x > 99.60%	\$ 1,000,000	\$ 2,000,000	\$ 2,500,000					
99.60% ≥ x > 99.55%	\$ 2,000,000	\$ 2,500,000						
x ≤ 99.55%	\$ 2,500,000							

Maximum Deduction: \$2,500,000
 Target: 99.90%

DRAFT

F-2 (k) KPI Calculation for Chilled Water - Unplanned Outage (Events)

Annual Score Events	Utilities Fee Deduction							
	0 Consecutive Event Years	2 Consecutive Event Years	3 Consecutive Event Years	4 Consecutive Event Years	5 Consecutive Event Years	6 Consecutive Event Years	7 Consecutive Event Years	8 Consecutive Event Years
x ≤ 3	\$ -	\$ -	\$ -	\$ -	\$ -	\$ -	\$ -	\$ -
x = 4	\$ -	\$ -	\$ 250,000	\$ 500,000	\$ 750,000	\$ 1,000,000	\$ 2,000,000	\$ 2,500,000
x = 5	\$ -	\$ 250,000	\$ 500,000	\$ 750,000	\$ 1,000,000	\$ 2,000,000	\$ 2,500,000	
x = 6	\$ 250,000	\$ 500,000	\$ 750,000	\$ 1,000,000	\$ 2,000,000	\$ 2,500,000		
x = 7	\$ 500,000	\$ 750,000	\$ 1,000,000	\$ 2,000,000	\$ 2,500,000			
x = 8	\$ 750,000	\$ 1,000,000	\$ 2,000,000	\$ 2,500,000				
x = 9	\$ 1,000,000	\$ 2,000,000	\$ 2,500,000					
x = 10	\$ 2,000,000	\$ 2,500,000						
x ≥ 11	\$ 2,500,000							

Maximum Deduction: \$2,500,000
 Target: 3

DRAFT

F-3 KPI Calculation for Cogeneration System - Unplanned Outage (Hours)

Annual Score % Availability	Utilities Fee Deduction								
	0 Consecutive Event Years	2 Consecutive Event Years	3 Consecutive Event Years	4 Consecutive Event Years	5 Consecutive Event Years	6 Consecutive Event Years	7 Consecutive Event Years	8 Consecutive Event Years	9 Consecutive Event Years
100.00% ≥ x > 94.00%	\$ -	\$ -	\$ -	\$ -	\$ -	\$ -	\$ -	\$ -	\$ -
94.00% ≥ x > 93.50%	\$ -	\$ -	\$ -	\$ 250,000	\$ 500,000	\$ 750,000	\$ 1,000,000	\$ 2,000,000	\$ 2,500,000
93.50% ≥ x > 93.00%	\$ -	\$ -	\$ 250,000	\$ 500,000	\$ 750,000	\$ 1,000,000	\$ 2,000,000	\$ 2,500,000	
93.00% ≥ x > 92.50%	\$ -	\$ 250,000	\$ 500,000	\$ 750,000	\$ 1,000,000	\$ 2,000,000	\$ 2,500,000		
92.50% ≥ x > 92.00%	\$ 250,000	\$ 500,000	\$ 750,000	\$ 1,000,000	\$ 2,000,000	\$ 2,500,000			
92.00% ≥ x > 91.50%	\$ 500,000	\$ 750,000	\$ 1,000,000	\$ 2,000,000	\$ 2,500,000				
91.50% ≥ x > 91.00%	\$ 750,000	\$ 1,000,000	\$ 2,000,000	\$ 2,500,000					
91.00% ≥ x > 90.50%	\$ 1,000,000	\$ 2,000,000	\$ 2,500,000						
90.50% ≥ x > 90.00%	\$ 2,000,000	\$ 2,500,000							
x ≤ 90.00%	\$ 2,500,000								

Maximum Deduction: \$2,500,000
 Target: 94.00%

DRAFT

F-4 KPI Calculation for Emergency Response - Emergency Response Time

Annual Score	Utilities Fee Deduction
Target = 0 - 2	\$ -
3 - 4	\$ 250,000
5 - 6	\$ 500,000
7 - 8	\$ 750,000
9 - 10	\$ 1,000,000
11 - 12	\$ 2,000,000
13 - 14	\$ 2,500,000

Business Hours:		Non-business Hours:	
Target ≤ 10 Minutes		Target ≤ 30 Minutes	
Response Time	Event Score	Response Time	Event Score
≤ 10 Mins	0	≤ 30 Mins	0
≤ 15 Mins	1	≤ 45 Mins	1
≤ 30 Mins	2	≤ 90 Mins	2
≤ 60 Mins	3	≤ 150 Mins	3
> 60 Mins	5	> 150 Mins	5

Maximum Deduction: \$2,500,000
Target: 2

DRAFT

CenTrio DBE Plan

LSU Utilities Modernization Initiative

As a responsible corporate citizen, CenTrio embraces diversity, equity and inclusion. To successfully accomplish our D&I goals, our plan includes the following components.



Construction and Engineering

Opportunities to realize equity outcomes during the construction of the project include, but are not limited to, ensuring the participation of disadvantaged business enterprise contractors, working with and supporting pre-apprenticeship and training programs that expand the pipeline of qualified workers, local hiring commitments, and other initiatives. Subcontractors who may not otherwise have the benefit of performing work on associated projects will be given the opportunity to expand, grow, and become more proficient in every area of the trade (i.e. accounting, trade skills, management, etc.) through the Utilities Modernization Improvement project. Furthermore, CenTrio's design-build contractor, Tiger Energy Partners (TEP), will be responsible, through its agreement with CenTrio, for implementing and reporting on its efforts to implement CenTrio's strategy for participation of disadvantaged business enterprise contractors in the construction process.

Our team will promote diversity and equity, and demonstrate accountability in the diversity and inclusion goals that have been set for this Project during the construction phase through employment of the following means:

DMM & Associates will oversee the reporting from TEP to ensure accuracy and commitment to participation when applicable.

Aggressive Outreach

Outreach and good faith efforts are needed to generate interest, identify recruitment sources and structure procurement to allow MBE/WBE/DBE contracting firms the opportunity for involvement. Some of the ways we may accomplish this goal include the following: community outreach meetings, advertisements (including to trade organizations, special interests group publications and large distribution publications), notification to related organizations, project scope forms, time lines and particulars sent to prospective MBE/WBE/DBE by mail, follow up by telephone after mailing, pre-bid meetings, structuring of bid packages to allow for breakdown of work and comparable scope between similar trades, and matching MBE/WBE/DBE's with prospective bidders on large packages where they may not be competitive,

The outreach efforts set forth above are intended to make the contracting opportunities widely recognizable in order to garner as much interest as possible from disadvantaged business enterprise contractors. A database will be created from responding Subcontractors that can be used for future targeted outreach when subsequent construction projects become available through the Utilities Modernization Initiative.

Targeted Bid Solicitation

In addition to general advertisements, specific outreach can be directed at organizations and special interest groups targeting the construction industry, including letters requesting initial interest and membership listings. Organizations

wishing to participate will have their members added to applicable bid solicitation contact lists. Another avenue for specific outreach includes speaking at organization meetings regarding available contracting opportunities. During these presentations, scopes of work with approximate dollar amounts can be made clear and known.

To accommodate bidding, construction drawings and documents may be forwarded to the organization. When a particular scope of work is published for bid solicitation, pre-bid meetings may be hosted if any of the following conditions are met: TEP/CenTrio deems it to be in the best interest of the subcontractors, subcontractors request a meeting, or the complexity of scope requires clarification.

Bid packages shall be structured for simplicity with easy identification of scope split between various subcontractors. To accommodate MBE/WBE/DBE participation, bid bonds shall not be requested unless deemed necessary by TEP/CenTrio or required by the University. Some of the factors on which necessity may be based are the following: scope is highly technical, work is critical to the project schedule, or scope of work is comprised of a high dollar value. Efforts will be made to ensure that all subcontractors bid on comparable scopes of work.

Equal Opportunity Measures

Emphasis will be placed on creating an environment conducive to equality among all subcontractors and employees regardless of age, race, or gender. CenTrio expects subcontractors to participate in such a work environment and requires acknowledgment of the same from TEP.

CenTrio will monitor TEP's efforts at employing minority participants, including through its subcontractors, and the outcomes of those efforts to ensure that adequate progress is made at employing minority participants throughout the construction phase.

Subcontractors will be informed of the emphasis being placed on minority participant employment and a subcontractor's commitment to such employment will be a factor in awarding of bids and hiring decisions.

Operations and Maintenance

Opportunities to promote equity during the ongoing operation of the Initial Modernization Project and future projects include, but are not limited to, ensuring the participation of disadvantaged business enterprise contractors, working with and supporting workforce development programs that expand the pipeline of qualified workers, local hiring and wage commitments, and other initiatives. For the ongoing operations and maintenance phase of the project, DMM & Associates will assist with the outreach efforts on behalf of CenTrio. Our team will track and archive all responses, and make them available for review by operations team members to promote a transparent process to our approach to equity in asset and facility management. Our team will also employ the following methods to promote equity and demonstrate accountability in the diversity and inclusion goals that have been set forth by the University:

Aggressive outreach

DBE engagement for the hiring of skilled workers for O&M activities will be coordinated by DMM & Associates. Our team will develop an aggressive outreach plan, generating interest for local workforce development through advertising and a direct, targeted, multi-level approach that will include:

- Newspaper
- Social Media
- Contact by fax/email/telephone follow-up (certified and "certifiable" businesses).
- Job Fairs

Educational Opportunities + Workforce Development

In conjunction with the University, CenTrio and DMM will investigate the potential for internship and apprenticeship opportunities aimed at minority, women, and diversity participants, including the potential for earning college credits through such opportunities. These opportunities will expand the pipeline of qualified, skilled workers in the area of central plant maintenance and engineering and represent a direct investment in minority communities.

Participation in Project Capital Structure

In order to achieve the best economic outcome for the University, CenTrio plans to access the US Private Placement market to fund approximately 90% of the Initial Modernization Project through the issuance of long-term Private Placement bonds. Private Placement debt investors typically are insurance companies, pension funds and other infrastructure debt investors who participate in an auction process and get an allocation of the total bond quantum based on the market clearing price. CenTrio intends to reach out to targeted DBE debt investors to determine their interest in participating in the PP debt issuance. If there are interested DBE investors, CenTrio plans to reserve and offer up to 5% of the PP debt issuance allocation to such DBE debt investors, subject to such DBE debt investors meeting applicable regulatory requirements with respect to private placement debt issuance and agreeing to the terms and conditions (both commercial and economic) of the note purchase agreement agreed to by the majority of the note holders.

In addition to the debt investors, CenTrio intends to explore opportunities for interested DBE equity investors to participate as minority equity holder(s) at the Concessionaire. Given the minority stake of the potential DBE investor(s) and the substantial upfront construction risk involved in the Initial Modernization Plan (IMP), CenTrio feels it is appropriate to explore such opportunities only after the substantial completion of the IMP, which will shield the potential DBE minority investors from undue construction risk and ensure smooth execution.

Community Outreach Plan

DMM & Associates will guide our team in the formation of an outreach plan that promotes diversity, inclusion, and equity.

The strategic communications efforts will include a combination of print, electronic, and social media, community outreach and stakeholder events. Media relations tasks, directed by DMM, will assist in establishing/maintaining open communication with media representatives that facilitate the dissemination of applicable project information to the community on a regular basis.

To successfully accomplish the aforementioned approach, our community outreach plan of action will consist of the following components:

Task 1 - Research

To conduct a thorough assessment of the demographics within the project parameters. Understanding the dynamics of the population will yield a data-driven, inclusive communications process. A stakeholder contact list will be developed and maintained for future correspondence.

Task 2 – Messaging

Building on the project narrative that has been established, our team will craft key messages that promote consistency, continuity, and accuracy of information about the project.

Task 3 – Core Outreach Tools

PRINT MEDIA

Print media will be leveraged to provide current status information about the project that validate the teams' commitment to transparency and engagement.

ELECTRONIC MEDIA

Personal interaction between the project team and the Baton Rouge community will be afforded through electronic media for the presentation of clear, concise information about varying phases of the project and its public inclusion efforts.

SOCIAL MEDIA

Use of social media will expand the opportunity to engage a broader, more diverse audience. It will also aid in the promotion of events.

JOB FAIRS

An inclusive method for communicating with the public regarding available employment opportunities and apprenticeships will be maintained through conducting job fairs, including outreach specifically targeted to historically black colleges and universities (HCBUs).

DRAFT



Board of Supervisors

ATHLETICS COMMITTEE

BOARD OF SUPERVISORS MEETING | OCTOBER 28-29, 2021



Board of Supervisors

Request from LSU A&M to Approve Contract Amendments for the Head Track & Field Coach

Date: October 29,2021

1. Bylaw Citation

Pursuant to Article VII, Section 1

L.3. Appointments and all other personnel actions relating to varsity athletics coaches and Athletic Directors receiving a salary of \$250,000 or above.

2. Summary of the Matter

This resolution seeks approval of the following proposed contract amendments for Dennis Shaver.

Name	Title	Term		Total Certain Compensation ^a
		Proposed Start Date	Proposed End Date	Proposed
Dennis Shaver	Head Coach - Track & Field	8/1/2021	6/30/2025	\$400,000

Notes:

- (a) Total Certain Compensation includes all compensation which the coach is contractually guaranteed to receive in the first year of the contract. It does not include the value of any fringe benefits, such as car and cell phone allowances, nor any one-time amounts, such as contract buy-outs or relocation allowances.

3. Review of Business Plan

Not applicable

4. Fiscal Impact

The Athletic Department currently expects that all funds relating to these employment contracts will be paid from revenues generated by the Athletic Department. While authorized by the contract, it is not expected that any foundation dollars will be needed to provide for any of the supplemental compensation. No state general fund or tuition dollars are used.

5. Description of Competitive Process

Not applicable

6. Review of Documents Related to Referenced Matter

The Office of General Counsel has reviewed each agreement.

7. Parties of Interest

LSU and the above-named athletics' personnel.



Board of Supervisors

8. Related Transactions

None

9. Conflicts of Interest

None.

10. Attachments

Contract for Dennis Shaver, Head Track & Field Coach.

RESOLUTION

NOW, THEREFORE, BE IT RESOLVED the Board of Supervisors of Louisiana State University and Agricultural & Mechanical College authorizes William F. Tate, IV, Ph.D., President, or his designee, to execute the position changes for Dennis Shaver as described in this item, in consultation with the General Counsel.

STATE OF LOUISIANA

PARISH OF EAST BATON ROUGE

EMPLOYMENT AGREEMENT

This Employment Agreement (“Agreement”) is made and entered into as of the 1st day of July, 2021, by and between Board of Supervisors of Louisiana State University and Agricultural and Mechanical College (“LSU” or “University”), a body corporate existing under the Constitution and laws of the State of Louisiana, herein represented by William F. Tate, IV, its duly authorized President, and Dennis Shaver (“EMPLOYEE”):

1. **Definitions.** For purposes of this Agreement, the following terms shall have the meaning shown:
 - A. “President”: The President of LSU.
 - B. “Athletic Director”: The Director of Athletics at LSU.
 - C. “Base Salary”: The annual sum of \$400,000.
 - D. “Position”: Head Coach of the Teams.
 - E. “Start Date”: August 1, 2021.
 - F. “End Date”: June 30, 2025.
 - G. “Program”: The intercollegiate Track & Field program at LSU.
 - H. “Team”: The intercollegiate athletic teams which are a part of the Program.
2. **Term.** The term (“Term”) of this Agreement shall be for a definite term, commencing on the Start Date and ending on the End Date unless terminated sooner in accordance with Sections 11 or 12 of this Agreement. Although this Agreement shall replace and supersede the Employment Agreement dated July 1, 2020, the terms of the Amendment to Employment Agreement dated December 1, 2020 shall remain in full force and effect as if replicated herein.
3. **Employment.** LSU does hereby employ EMPLOYEE in the Position for the Term. EMPLOYEE will report directly to the Athletic Director or the Athletic Director’s designee. It is the goal of the parties that Employee will serve in the Position for the entirety of the Term. To the extent annual compensation under this Agreement exceeds \$100,000, EMPLOYEE hereby agrees and promises that EMPLOYEE shall provide, within 30 days of the Start Date, proof to LSU that EMPLOYEE has been issued a Louisiana driver’s license and that all vehicles registered in EMPLOYEE’s name are registered in Louisiana, all pursuant to the requirements of La. R.S. 42:31.

4. **Duties and Responsibilities.** EMPLOYEE's duties and responsibilities shall include the following, all subject to law, LSU policy, and the directives, input, and advice of the President and the Athletic Director:

- A. Administering, managing, and leading the Program in a professionally appropriate and competent manner;
- B. Administering, managing, and leading the Program in an effort to effectively compete in National Collegiate Athletic Association (NCAA) play;
- C. Hiring and firing (subject to appropriate budget approvals, such approvals not to be unreasonably withheld or delayed) and managing the assistant coaches and other athletic staff necessary and appropriate to assist EMPLOYEE in meeting the responsibilities herein;
- D. Performing all duties reasonably assigned to EMPLOYEE by the Athletic Director so long as such duties are consistent with those duties typically assigned to Head Coaches at colleges or universities at the same competitive level as LSU;
- E. Promoting and monitoring the success of the Team and its student-athletes both athletically and academically;
- F. Directing the Team, including management of staff, budget, and other resources;
- G. Understanding and agreeing that EMPLOYEE and EMPLOYEE's staff, with the reasonable assistance of LSU, are bound by and must be reasonably knowledgeable of and comply with: (1) all applicable federal and state laws governing intercollegiate athletics; and (2) all governing constitutions, by-laws, rules, policies, interpretations, and regulations of the NCAA, the Southeastern Conference ("SEC") and/or LSU (hereinafter collectively referred to as "Governing Athletics Regulations");
- H. Promptly reporting any known or reasonably suspected violation of Governing Athletics Regulations to the Athletic Director and the Director of Compliance;
- I. Understanding and complying with Title IX of the Education Amendments of 1972 and LSU policies on Title IX and sexual misconduct, including but not limited to Permanent Memorandum 73 ("PM-73") and, as a Responsible Person under PM-73, understanding and complying with the obligation to report incidents of sexual misconduct (including sexual harassment and sexual violence) and other inappropriate sexual conduct of which EMPLOYEE has knowledge or receives notice to LSU's Title IX Coordinator and other appropriate designee as required by PM-73;
- J. Understanding and complying with Title VI of the Civil Rights Act of 1964, other federal laws, state law, and LSU policies on equal opportunity and discrimination, including, but not limited to, Permanent Memorandum 55;

- K. Cooperating fully in any investigation of possible violations of any Governing Athletics Regulations conducted or authorized by LSU, the SEC, or the NCAA at any time, and cooperating fully in any LSU internal investigation or inquiry;
 - L. Reasonably observing, respecting, and promoting the principles of institutional control in the Program;
 - M. Reasonably understanding, observing, upholding, and promoting LSU's written academic standards, requirements, and policies, and reasonably promoting an environment in which admissions, financial aid, academic services for student-athletes, and recruiting can be conducted consistent with LSU's mission;
 - N. Cultivating and maintaining reasonable interaction with the Board of Supervisors, affiliated foundations, athletic conferences, institutional alumni, the media, the public, students, faculty, staff and other members of the LSU community, in accordance with the policies and instructions of the Athletic Director;
 - O. Performing all duties in a manner consistent with good sportsmanship and in accordance with the high moral, ethical, and academic standards of the Department of Athletics and LSU;
 - P. Using reasonable efforts, through due care and supervision, to ensure that all student-athletes and other individuals under or subject to EMPLOYEE's control, authority, or supervision comply with all Governing Athletics Regulations and act in accordance with the high moral, ethical, and academic standards of the Program and LSU;
 - Q. Using reasonable efforts to promote the goal of LSU that every student-athlete obtains an undergraduate degree, and reasonably cooperating with academic counselors or similar persons designated by LSU to assist student-athletes and the faculty and administrators of LSU in connection with the academic pursuits of student-athletes;
 - R. Understanding and complying with NCAA Bylaw 11.1.1.1, which provides: "An institution's head coach is presumed to be responsible for the actions of all institutional staff members who report, directly or indirectly, to the head coach. An institution's head coach shall promote an atmosphere of compliance within his or her program and shall monitor the activities of all institutional staff members involved with the program who report, directly or indirectly, to the coach;" and
 - S. Performing all other reasonable duties customarily performed by head coaches in similar programs at colleges or universities competing at the same level as LSU.
5. **Sports Camps.** EMPLOYEE, subject to Governing Athletics Regulations and Athletic Department guidelines, rules and regulations, may operate or work at sports camps or clinics at LSU. LSU does not guarantee or provide any supplemental compensation or additional revenue from operation of sports camps or clinics. EMPLOYEE shall not be permitted to sell, assign, lease, donate or otherwise transfer any ownership, assets or

interests in such a camp or clinic to any other person or entity without the prior written approval of the President. Use of University facilities by sports camps must comply with University policy.

6. **Base Salary.** LSU agrees to pay EMPLOYEE the Base Salary annually, in 12 equal monthly installments, on LSU's regular monthly payroll date. The Base Salary shall be reviewed at the end of each season of Program and may be adjusted at that time by the Athletic Director, subject to recommendation, review, and approval pursuant to LSU personnel policies and LSU Bylaws and Regulations. However, in no event will EMPLOYEE's Base Salary be reduced as a result of any such review.
7. **Supplemental Compensation.** EMPLOYEE shall be entitled to Supplemental Compensation as provided on Schedule A, which is attached to and made a part of this Agreement. Supplemental Compensation may be payable, in whole or in part, from affiliated foundation funds.
8. **Incentive Compensation.** EMPLOYEE may be entitled to Incentive Compensation in the amounts and for meeting the goals set forth in Schedule A, which is attached to and made a part of this Agreement. Incentive Compensation may be payable, in whole or in part, from affiliated foundation funds.
9. **Retirement and Fringe Benefits.** EMPLOYEE shall be entitled to the following benefits, part of which may be paid from affiliated foundation funds:
 - A. Retirement and fringe benefit programs available to all unclassified professional LSU employees, with contributions and benefit amounts as defined by law. EMPLOYEE understands and agrees that no contributions for purposes of any State of Louisiana retirement program will be made by LSU or withheld from EMPLOYEE's compensation except as to the Base Salary and any earned Post-Season Incentive Compensation, and EMPLOYEE shall not be entitled to any retirement benefits that may otherwise be attributable to any other compensation paid pursuant to this Agreement. EMPLOYEE further acknowledges that sums paid under Sections 5 (Sports Camps), 7 (Supplemental Compensation) and 10 (Additional Revenue) shall not be considered "base pay," "earned compensation," or "earnable compensation" as such terms are defined under Louisiana law, and shall not be included as compensation for the purpose of computation of retirement benefits. Retirement contributions are subject to the limitations of federal law and Louisiana law.
 - B. As part of any third-party apparel and/or equipment related contract with LSU, EMPLOYEE acknowledges and agrees that Team may be provided and/or allocated apparel and/or equipment from and by LSU, which apparel and equipment shall be used exclusively and solely by EMPLOYEE in furtherance of EMPLOYEE'S employment duties and Team-related activities as applicable to EMPLOYEE'S employment with LSU.

10. Additional Revenue.

- A. Subject to compliance with Governing Athletics Regulations, including but not limited to current NCAA Bylaw 11.2.2 and 11.3.2, and LSU Permanent Memorandum 11 (“PM-11”), EMPLOYEE may earn or receive other revenue (“Additional Revenue”) while employed by LSU, including working with sports camps or clinics, provided, however, that EMPLOYEE shall obtain prior written approval from the President before engaging in any commercial or private venture, including the use of EMPLOYEE’s name by any commercial, public or private entity, which approval shall not be unreasonably withheld. EMPLOYEE shall report annually to the President and the Athletic Director, in writing, in compliance with NCAA Bylaws 11.2.2, 11.3.2.1, and 11.3.2.1.1, and any applicable LSU policy, all athletically-related income or benefits received by EMPLOYEE from sources outside LSU, and LSU shall have reasonable access to all records of EMPLOYEE to verify this report. LSU does not guarantee any amount of Additional Revenue.
- B. EMPLOYEE shall not, without written approval of the President and the Athletic Director and compliance with PM-11, arrange for or agree to the receipt by any other employee of any supplemental pay, bonus, or other form of payment from any outside source.
- C. EMPLOYEE shall not, without the prior written approval of the Athletic Director or the Athletic Director’s designee, appear on, or in, any radio, television, or internet programs or other electronic medium other than those produced or sponsored by LSU, except routine news media interviews or educational or development programs for which no compensation is received. EMPLOYEE shall not appear in or make any advertisement or make any commercial endorsement without the prior written approval of the President and the Athletic Director.

11. Termination and Suspension.

- A. **Termination by LSU for Cause.** This Agreement may be terminated for “cause” by LSU, acting through the President, at any time prior to its expiration, upon written notice to EMPLOYEE.
 - 1. For purposes of this Section, “cause” for termination shall be defined particularly but not exclusively as:
 - a. Committing a material and substantial violation (including repeated lesser violations) of Governing Athletics Regulations; failing promptly to report any such violation by another person to the Director of Compliance; or committing a material and substantial violation of any LSU policies, rules, or procedures that are within the scope and/or meet the definition of Governing Athletics Regulations;

- b. Committing a material and substantial violation of Governing Athletics Regulations involving any aspect of the Program by any other person if either: (i) the violation occurs or continues to occur after EMPLOYEE knew or had constructive knowledge that it was about to occur or was occurring, or (ii) EMPLOYEE failed to establish and maintain reasonable policies and procedures, or to follow reasonable policies and procedures established in writing by the Athletic Department for the Program to prevent violations of Governing Athletics Regulations from occurring and to detect promptly any such violations which may occur;
- c. Committing or being convicted of either: (i) any felony, or (ii) any misdemeanor involving gambling, drugs, or alcohol;
- d. Engaging in serious misconduct which either: (i) displays a continual, serious disrespect or continual, serious disregard for the mission of LSU; (ii) brings EMPLOYEE into substantial public disrepute sufficient to materially impair EMPLOYEE's ability to perform the obligations contained herein without material adverse impact on the Team or Program; or (iii) constitutes moral turpitude or breaches the high moral and ethical standards applicable to EMPLOYEE as a visible representative of LSU, including but not limited to, acts of dishonesty, misrepresentation, fraud, or violence that may or may not rise to level of warranting criminal prosecution by the relevant authorities;
- e. Unreasonable refusal or repeated failure to perform any duties imposed upon EMPLOYEE herein (including, but not limited to, those duties specified in this Agreement), or failing to perform the same to the best of EMPLOYEE's reasonable ability;
- f. Prolonged absence from LSU without consent, which will not be unreasonably withheld;
- g. Committing fraud in the performance of any duties and responsibilities herein, either with intent or reckless disregard for the truth, including but not limited to fraud or dishonesty in any written or verbal statements, including résumés, provided by EMPLOYEE to LSU in the application process or fraud in the preparation, falsification, or alteration of documents or records of LSU, the NCAA, or the SEC, or documents or records pertaining to any recruit or student athlete, including without limitation transcripts, eligibility forms, and compliance reports; or knowingly permitting any other person to commit such fraud;
- h. Failure to respond reasonably accurately and fully within a reasonable time to any reasonable requests or inquiry relating to

the performance of any duties herein or at any prior employment at any other institution of higher learning propounded by LSU, the NCAA, the SEC or any other governing body having supervision over the athletic programs of LSU or such other institution of higher education, or required by law or Governing Athletics Regulations; or knowingly permitting any other person to fail to so respond;

- i. Participation in any gambling, bookmaking, wagering, or betting involving any athletic contest whether by soliciting, placing, or accepting a bet or wager or through a bookmaker, a pool, or any other method of gambling; or knowingly permitting any student athlete or other individual under EMPLOYEE's control, authority, or supervision to participate in such activity;
- j. Providing information or data, other than information or data provided to the general public through public presentation, relating in any manner to any intercollegiate sport or to any student athlete to any individual whom EMPLOYEE knows (or has constructive knowledge) to be a gambler, better, or bookmaker, or an agent of any such person; or knowingly permitting any student athlete or other individual under EMPLOYEE's control, authority, or supervision to furnish such information or data;
- k. Use or consumption of alcoholic beverages or controlled substances, steroids, or other drugs or chemicals to such degree and for such appreciable period as to substantially impair EMPLOYEE's ability to perform the duties herein;
- l. Sale, purchase, use or possession of any controlled substances, steroids, or other drugs or chemicals, the sale, purchase, use, or possession of which by EMPLOYEE is prohibited by law or Governing Athletics Rules. The provisions of this subsection do not prohibit the use or possession of substances or drugs lawfully prescribed by a healthcare provider, and used in accordance therewith.
- m. Knowingly encouraging or allowing the sale, purchase, use, or possession by any student athlete or other individual under EMPLOYEE's control, authority, or supervision of any controlled substances, steroids, or other drugs or chemicals, the sale, purchase, use, or possession of which by such person is prohibited by law or Governing Athletics Rules;
- n. Failing reasonably to cooperate in the investigation and enforcement of Governing Athletics Regulations or in any LSU

internal investigation or inquiry; or knowingly permitting any other person to fail to cooperate in such investigation and enforcement;

- o. Subject to any right of administrative appeal permitted or granted to EMPLOYEE by the NCAA or SEC, any finding or determination by the NCAA, SEC, or any commission, committee, council, or tribunal of the same, of any major or repetitive violations by EMPLOYEE of NCAA or SEC rules, or of any such major or repetitive violations by others under the direct supervision of EMPLOYEE which were knowingly and intentionally permitted, encouraged, or condoned by EMPLOYEE, or about which violations EMPLOYEE knew or should have known and should have acted reasonably to prevent, limit, or mitigate (it is recognized that this subsection includes findings or determinations of violations during employment of EMPLOYEE at any other institution of higher education);
 - p. Failing to report promptly to the Director of Compliance any violations of Governing Athletics Regulations involving the Team of which EMPLOYEE has actual knowledge;
 - q. Failure by EMPLOYEE to engage in, and use best efforts to ensure that personnel under EMPLOYEE's direct or indirect supervision engage in, safe and responsible treatment of student athletes on the Team, including without limitation failure to comply with any requirement pertaining to medical clearance for participation, or any other act or omission (including but not limited to physical and/or emotional abuse of student athletes) that creates, or could reasonably be expected to create, an unreasonable risk of harm to a student athlete;
 - r. Failure to comply with LSU policies, rules and regulations concerning Title IX, including specifically but not exclusively the reporting of any incident of sexual misconduct in accordance with LSU's Title IX policy and PM-73; or
 - s. Knowingly committing material violation(s) of the terms of this Agreement.
2. In the event of termination for cause, EMPLOYEE's Base Salary, Supplemental Compensation, Fringe Benefits and all other compensation and benefits provided for in this Agreement shall terminate on the termination date, and LSU shall not thereafter be liable to EMPLOYEE for any sums or damages other than compensation earned prior to the termination date. The termination date shall be the date on which the initial notice of termination is given, or on such later date as may be set forth by LSU in the notice of termination. Should the EMPLOYEE be

reinstated following a hearing, EMPLOYEE shall be paid any lost compensation and benefits, retroactive to the date of the initial notice of termination.

3. Prior to termination for cause, EMPLOYEE shall be provided with written notice of contemplated termination and a statement of the grounds and facts in support thereof and shall have five calendar days from receipt of such notice to respond in writing and/or present documents or other written evidence to the Athletics Director. After review of any such response, the Athletics Director or the Athletics Director's designee shall provide EMPLOYEE written notice of a decision.
4. Within five calendar days of receipt of the decision, EMPLOYEE may make a written request for a hearing to the President. If no such request is made, the decision of the Athletics Director is final. If a request for hearing is made, the President or the President's designee shall conduct the hearing. The hearing and related proceedings shall not be open to the public. EMPLOYEE has the right to an advisor, including legal counsel, at the hearing but the advisor or counsel may not participate in the hearing, question witnesses or address the President or President's designee. Within five calendar days of the hearing, EMPLOYEE will be provided written notice of the decision of the President, which will be final.
5. As required by NCAA Bylaw 11.2.1, EMPLOYEE is hereby notified that in addition to the actions LSU may take in accordance with this Agreement, EMPLOYEE is also subject to disciplinary or corrective action as set forth in the provisions of the NCAA enforcement procedures if EMPLOYEE is found by the NCAA or LSU to be in violation of NCAA Bylaws. EMPLOYEE agrees that LSU shall implement any such disciplinary or corrective actions imposed by the NCAA. EMPLOYEE further understands that EMPLOYEE has an affirmative obligation to cooperate fully in the NCAA infractions process, including the investigation and adjudication of a case, pursuant to this Agreement and NCAA Bylaw 11.2.1, and that such obligation continues in effect during and beyond the termination of this Agreement for any violations alleged to have occurred during EMPLOYEE's employment by LSU.

B. Termination by LSU without Cause.

1. LSU shall have the right to terminate this Agreement without cause upon written notice to EMPLOYEE. In such event, LSU will pay EMPLOYEE liquidated damages in lieu of any and all other legal remedies or equitable relief as detailed below and as provided in Schedule A.
2. In the event of termination by LSU without cause, EMPLOYEE's Base Salary, Supplemental Compensation (if any), Fringe Benefits, and all other compensation and benefits provided for in this Agreement shall terminate

on the termination date, and LSU shall not thereafter be liable to EMPLOYEE for any sums or damages other than the liquidated damages provided for herein and any compensation earned pursuant to this Agreement prior to the termination date. The termination date shall be the date on which notice of termination is given, or on such later date as may be set forth by LSU in the notice of termination.

3. Liquidated damages under this Section will be paid in equal monthly installments over a period of time equal to the amount of time then remaining in the Term, including any extended term.
4. In the event of termination by LSU without cause, the amount of liquidated damages owed by LSU under this Section shall be reduced and extinguished by and to the extent of any compensation EMPLOYEE earns, receives, or is entitled to receive for athletics-related employment from any third party from the termination date until LSU's obligation pursuant to this Section to EMPLOYEE terminates or ceases to exist. EMPLOYEE shall exercise due diligence and good faith in seeking other athletically-related employment. In the event EMPLOYEE obtains such other employment, EMPLOYEE must notify LSU and provide any and all documentation requested by LSU to determine the amount of compensation received by EMPLOYEE and the amount of offset due to LSU.
5. The parties have bargained for this liquidated damages provision. This is an agreement for personal services. The parties recognize that termination of this Agreement by LSU prior to its expiration by lapse of term would cause EMPLOYEE to lose the salary, supplemental compensation, fringe benefits, certain other LSU-provided benefits, and possibly other income and benefits provided by third parties, which damages are impossible to determine with certainty. As such, the damages that may be suffered by EMPLOYEE in the event of a termination of this Agreement by LSU without cause are difficult to presently and accurately estimate. In addition, the parties expressly agree that the liquidated damages herein are not in any way a penalty.

C. Termination by EMPLOYEE Without Cause.

1. EMPLOYEE shall have the right to terminate this Agreement without cause upon written notice to LSU. In the event EMPLOYEE terminates this Agreement without cause, EMPLOYEE will pay LSU liquidated damages, in lieu of any and all other legal remedies or equitable relief. In the event of termination by EMPLOYEE without cause, EMPLOYEE's Base Salary, Supplemental Compensation (if any), Fringe Benefits, and all other compensation and benefits provided for in this Agreement shall terminate on the termination date, which, unless otherwise agreed to in writing by LSU on one hand and EMPLOYEE on the other hand, shall be

the earlier of: (a) the date on which EMPLOYEE provides notice of termination to LSU; (b) the date on which EMPLOYEE accepts employment from another employer; or (c) the date on which EMPLOYEE performs any work or services of any kind or nature whatsoever on behalf of or for the benefit of another employer. LSU shall not thereafter be liable to EMPLOYEE for any sums or damages other than any compensation earned pursuant to this Agreement prior to the termination date, other than any earned by unpaid Incentive Compensation. The Parties acknowledge that this provision is intended to obligate EMPLOYEE to repay unearned compensation and fees previously received under the premise that EMPLOYEE would fulfill the Term of this Agreement.

2. If EMPLOYEE terminates employment during the Term, EMPLOYEE will pay to LSU liquidated damages as provided on Schedule A. EMPLOYEE shall have the option to pay such amount in a lump sum or in equal monthly installments over a period of time equal to the amount of time then remaining in the Agreement, including any extended term.
3. Liquidated damages under this Section may be waived, in the sole discretion of the President, if EMPLOYEE is not in breach of any provision of this Agreement and LSU determines that such a waiver would serve the best interests of LSU, considering factors such as, but not limited to, EMPLOYEE's length of service with LSU, whether EMPLOYEE is taking another athletically-related job, the impact the timing of EMPLOYEE notice has on the Team (whether it is given before, during, or after the Team's season and recruiting period), EMPLOYEE's ability and willingness to assist LSU if requested during any transition period (such as during post-season play after giving notice at the end of the regular season), ease of recruiting a replacement for EMPLOYEE, and the impact that the payment of liquidated damages would have on recruiting and retaining other similarly-situated coaches.
4. The parties have bargained for this liquidated damages provision. This is an agreement for personal services. The parties recognize that termination of this Agreement by EMPLOYEE prior to its expiration by lapse of term would cause LSU to incur administrative, recruiting, and resettlement costs in obtaining a replacement coach for Team, in addition to potentially increased compensation costs and loss of ticket revenues, which damages are impossible to determine with any certainty.
5. Unless notice of termination under this Section has been given by either party, neither EMPLOYEE nor EMPLOYEE's agent shall, under any circumstances, discuss or negotiate directly or indirectly prospective employment for EMPLOYEE with any other institution of higher education, professional athletic team, or other athletically-related (including media and sports marketing) prospective employer without

giving prior written notice (which written notice shall for the purposes of this Section include electronic mail) to the President and the Athletic Director.

D. Suspension or Other Disciplinary Action.

1. In lieu of termination for cause, and apart from any rights it may have under this Agreement, LSU may impose disciplinary sanctions less severe than termination upon EMPLOYEE, up to and including suspension or leave without pay for a period no longer than 90 days for any act or omission which would be grounds for discipline or termination for cause. Imposition of such sanctions shall be at the discretion of LSU, which shall not be exercised arbitrarily or capriciously. Prior to suspension without pay under this provision, EMPLOYEE shall be provided written notice of the grounds for the suspension and shall have five calendar days from receipt of such notice to respond in writing to the Athletic Director. After review of any such response, the Athletic Director or the Athletic Director's designee(s) will provide EMPLOYEE with written notice of a decision and/or suspension.
2. Upon written notice and after reasonable opportunity to respond in writing, LSU may suspend EMPLOYEE for an indefinite period during any investigation by LSU, another governmental entity, or the NCAA or SEC to determine whether EMPLOYEE has violated any laws or Governing Athletics Regulations. During such suspension, EMPLOYEE shall receive only the Base Salary and any compensation earned but not yet paid as of the date of the suspension, along with fringe benefits provided under Section 9 of this Agreement, and shall not be entitled to receive any other benefits, compensation or remuneration set forth in this Agreement for the period of such suspension. If the matter giving rise to the suspension is finally resolved completely in favor of EMPLOYEE, and does not otherwise represent an independent basis for termination herein for cause, LSU shall pay or make available to EMPLOYEE the benefits and other compensation herein otherwise payable to EMPLOYEE during the period of suspension. Any such benefits which are payable pursuant to this Agreement by an affiliated foundation shall only be paid by such foundation, subject to its approval. Suspension under this subsection shall not limit any rights of LSU to terminate EMPLOYEE for cause.
3. EMPLOYEE shall be subject to disciplinary or corrective action by the NCAA or SEC for any violation of NCAA and SEC regulations, respectively. Such action by the NCAA or the SEC shall not preclude or in any manner affect LSU's right to take such other corrective or disciplinary action as it deems necessary or proper, including termination for cause.
4. Notwithstanding any other provision of this Agreement to the contrary, if EMPLOYEE is suspended by the SEC or NCAA, EMPLOYEE shall

automatically be suspended by LSU for the duration of the SEC or NCAA imposed suspension without further notice or process. During such suspension, EMPLOYEE shall not be entitled to receive any compensation, benefits or any other payments under this Agreement except for fringe benefits provided under Section 9 of this Agreement.

- E. **Termination by Death or Disability.** In the event of the death of EMPLOYEE or the inability of EMPLOYEE to perform the obligations described in this Agreement with or without accommodation by reason of disability or some other occurrence beyond the control of either party, and such inability to perform has continued or will continue beyond a reasonable period of time, but not less than 60 days, this Agreement shall terminate as a termination with cause and all future obligations between the parties shall cease upon the termination date reasonably established by LSU, unless otherwise required by law.
- F. **Waiver of Claims.** The financial consequences of termination of this Agreement or suspension herein are exclusively set forth herein. Therefore, with the sole exception of payments required by this Agreement, in any instance of termination for cause or without cause, or suspension or other disciplinary sanction effected in accordance with the procedures established in this Agreement, neither EMPLOYEE nor LSU shall be entitled to receive, and each hereby waives any claim against the other, and their respective board members, officers, directors, agents, employees, successors, and personal representatives for consequential damages by reason of any alleged economic loss, including without limitation loss of collateral income, deferred income, loss of earning capacity, loss of business opportunity, loss of perquisites, loss of fees from speaking, camps or other outside activity, or damages allegedly sustained by reason of alleged humiliation or defamation or other non-compensatory and compensatory damages and attorney's fees resulting from the fact of termination, the public announcement thereof, or the release by LSU or EMPLOYEE of information or documents required by law. EMPLOYEE acknowledges that in the event of either termination of this Agreement for cause, without cause, or otherwise, or suspension or other disciplinary sanction effected in accordance with the procedures established in this Agreement, EMPLOYEE shall have no right to occupy the Position and that EMPLOYEE's sole remedies are provided herein and shall not extend to injunctive relief. EMPLOYEE further acknowledges and agrees that EMPLOYEE is not eligible for and will not be considered for or granted tenure by LSU.
12. **Discontinuation of the Program by the University.** Notwithstanding any provision to the contrary, in the event the University determines for any reason within its sole discretion to discontinue the Program as a Division I sport, or if the entirety of either gender Team of the Program is discontinued (the entire women's Team or the entire men's Team), or a single sport within a Team or Program is discontinued (e.g., men's and/or women's indoor track and field), LSU shall have the right to terminate this Agreement without further obligation to EMPLOYEE. Notice of termination under this Section shall be in writing and shall establish a date of termination no less than 90 days from the date of the notice or upon the End Date, whichever occurs first. In the event a

single sport is discontinued, LSU and EMPLOYEE may attempt a good faith negotiation of revised terms and compensation considering the reduced duties of the Position; however, if negotiations are unsuccessful, the right to terminate under this Section shall remain. In the event the right to terminate pursuant to this Section is exercised, all obligations between the parties shall cease effective on the date of termination.

13. Retention and Return of all Materials, Records, and Other Items. All documents, records, or materials, including without limitation personnel records, recruiting records, team information, films, statistics, or any other material or data furnished to EMPLOYEE by LSU or developed by EMPLOYEE on behalf of or at the expense of LSU or otherwise in connection with the employment of EMPLOYEE are and shall remain the sole and confidential property of LSU. Within 10 days of the expiration or termination of this Agreement, EMPLOYEE shall cause any such materials in EMPLOYEE's possession or control to be delivered to LSU. At the same time, EMPLOYEE shall return to LSU all credit cards, keys, computers, automobiles, mobile communication devices and other items belonging to LSU which were issued to or are in the possession of EMPLOYEE.

14. Leave and Overtime.

A. **No Annual Leave.** Because of the specific nature of EMPLOYEE's job duties and the irregular times during which EMPLOYEE will be required to perform those job duties (for example, working in excess of 40 hours per week during Team's season, post-season, and recruiting period, while having fewer responsibilities in the off-season), EMPLOYEE acknowledges and agrees that EMPLOYEE will not earn or accrue annual leave.

1. EMPLOYEE's Base Salary has been mutually negotiated with this understanding, and both EMPLOYEE and LSU agree that the Base Salary would be less if EMPLOYEE were entitled to earn annual leave.
2. If any administrative tribunal, statewide elected official, or state board or commission with jurisdiction over such matters, or any court of competent jurisdiction, rules or publishes a formal written opinion or decision that Louisiana law requires EMPLOYEE to earn annual leave, and such rule or opinion is binding on LSU or LSU otherwise determines to comply with the opinion or ruling, then EMPLOYEE's Base Salary shall be reduced by the dollar value of the annual leave for which EMPLOYEE is credited (using the dollar value of such annual leave as of the date on which the opinion or ruling is published). This reduction shall be retroactive to the date on which EMPLOYEE's earning of annual leave is calculated to begin, and EMPLOYEE shall repay to LSU the amount of the reduction. EMPLOYEE shall pay LSU any amount owed as a result of this retroactive reduction in equal monthly installments for a period of 12 months (or such longer or shorter period as may be mutually agreed in writing by EMPLOYEE and LSU) from the date on which the EMPLOYEE is given notice that EMPLOYEE will be credited with annual leave pursuant to this Section. In the alternative, if not prohibited

by the ruling or otherwise disallowed by law, EMPLOYEE may waive EMPLOYEE's right to annual leave (both retroactively and/or prospectively) in lieu of making the payments that would otherwise be required under this Section.

3. This Section 14(A) shall not apply if EMPLOYEE has accrued annual leave through employment with LSU prior to the Effective Date without separation of employment.
 - B. **No Overtime.** EMPLOYEE qualifies and is designated as exempt under the Fair Labor Standards Act and is not be entitled to any overtime pay or compensatory leave for work in excess of 40 hours in any workweek.
 - C. **Sick Leave.** EMPLOYEE will accrue and use sick leave in accordance with LSU policy.
 - D. **Notice of Absence.** EMPLOYEE is required to receive authorization from the Athletic Director or the Athletic Director's designee prior to being absent from EMPLOYEE's usual duties and responsibilities, not to be unreasonably withheld.
15. **Non-Assignment.** Neither party may assign, transfer, alienate, or encumber any of its rights or obligations hereunder without the express written consent of the other party, except as otherwise specifically set forth in this Agreement.
16. **Entire Agreement.** This Agreement constitutes and expresses the entire agreement and understanding of the parties concerning the employment of EMPLOYEE by LSU and shall, upon the effective date hereof, supersede any other oral and written agreements between the parties. There are no oral or other agreements, understandings, promises, or representations between the parties affecting this Agreement. Both parties have relied solely on their own respective judgments in entering into this Agreement, with full opportunity to seek advice of competent counsel. It shall be construed, if necessary, without reference to the party that was the principal drafter of the Agreement.
17. **Indirect Actions Prohibited.** Any act which EMPLOYEE is prohibited from doing directly in this Agreement may not be done indirectly by EMPLOYEE or another person on EMPLOYEE's behalf or at EMPLOYEE's behest.
18. **Amendments to Agreement.** This Agreement may be amended only by a written instrument duly approved by LSU through its designated representatives and accepted by EMPLOYEE, such approval and acceptance to be acknowledged in writing.
19. **Severability.** If any provision of this Agreement shall be deemed invalid or unenforceable, either in whole or in part, this Agreement shall be deemed amended to delete or modify, as necessary, the offending provision or to alter the bounds thereof in order to render it valid and enforceable.
20. **No Waiver of Default.** No waiver by the parties hereto of any default or breach of any covenant, term or condition of this Agreement shall be deemed to be a waiver of any

other default or breach of the same or any other covenant, term or condition contained herein.

21. **No Waiver of Sovereign Immunity.** It is expressly agreed and understood between the parties that nothing contained herein shall be construed to constitute a waiver or relinquishment by LSU of any rights to claim such exemptions, privileges and immunities as may be provided by law.
22. **“Force Majeure” Clause.** Neither party shall be considered in default of performance of any obligations under this Agreement if such performance is prevented or delayed by Force Majeure. “Force Majeure” shall be understood to be any cause which is beyond the reasonable control of the party affected and which is forthwith, by notice from the party affected, brought to the attention of the other party, including but not limited to war, hostilities, revolution, civil unrest, strike, lockout, epidemic or pandemic, government-ordered restriction or cessation of activity, accident, fire, natural disaster, wind or flood or any requirements of law, or an act of God.
23. **Governing Law and Venue.** This Agreement shall be enforced and construed in accordance with the laws of Louisiana. Any civil action to enforce this Agreement shall be brought in a state or federal court having jurisdiction and domiciled in East Baton Rouge Parish, Louisiana.

SIGNATURES ON FOLLOWING PAGE

SCHEDULE A
SUPPLEMENTAL TERMS FOR DENNIS SHAVER

This Schedule A supplements and further defines the provisions of the Employment Agreement entered into between LSU and EMPLOYEE to which it is attached (the "Agreement"). In the event of a direct and clear conflict between the other provisions of the Agreement and this Schedule A, the provisions of this Schedule A shall control.

1. Supplemental Compensation. Pursuant to Section 7 of the Agreement, Supplemental Compensation is payable as follows.

- A. **Media Participation.** While employed under this Agreement, EMPLOYEE will earn and receive Supplemental Compensation during each calendar year of this Agreement in the following annualized amounts payable in 12 equal monthly installments on LSU's regular monthly payroll date and pro-rated appropriately for partial years and months:

Start Date through June 30, 2022:	\$50,000
July 1, 2022 through June 30, 2023:	\$75,000
July 1, 2023 through June 30, 2024:	\$100,000
July 1, 2024 through June 30, 2025:	\$125,000

This compensation to EMPLOYEE is for being available for, appearing on or participating in, as requested, University sanctioned television, radio and internet programming concerning LSU and the Team.

- B. **Program Longevity Compensation.** If EMPLOYEE remains continuously employed with LSU in the Position and is in the Position on the following dates, LSU shall provide additional Supplemental Compensation in recognition for the continued benefit to the Program and the Team. Supplemental Compensation under this Section shall be payable within 60 days of achieving the designated milestone.

June 30, 2022:	\$25,000
June 30, 2023:	\$25,000
June 30, 2024:	\$25,000
June 30, 2025:	\$25,000

2. Incentive Compensation Schedule. Pursuant to Section 8 of the Agreement, Incentive Compensation is payable as follows.

- A. **Post-Season Incentive Compensation.** Subject to the terms and conditions set forth in the Agreement, EMPLOYEE shall receive Post-Season Incentive Compensation in the amounts and based on the Team attaining the goals shown below.

1. SEC Meet Champion \$ 25,000 AND
2. NCAA Incentive Compensation Goals for National Championship Meet:
 - a. Top 7 Finish \$ 20,000 OR
 - b. Top 5 Finish \$ 35,000 OR
 - c. Second Place Finish \$ 50,000 OR
 - d. NCAA National Champion \$100,000
3. For Post-Season Incentive Compensation, EMPLOYEE shall earn the full amount for the highest gender Team achievement and one-half the amount for the lesser gender Team achievement. The maximum amount of Post-Season Incentive Compensation payable to EMPLOYEE in a contract year shall be \$187,500.
4. Post-Season Incentive Compensation is additional compensation for the extra services required of EMPLOYEE in the preparation for and participation in post-season play. If payable, Post-Season Incentive Compensation shall be paid within 60 days following the final postseason game in which Team participates.
5. If EMPLOYEE does not actively coach the Team in the Position for any post-season game for any reason, including but not limited to termination or re-assignment of position, EMPLOYEE shall not be entitled to Post-Season Incentive Compensation.

B. Coaching Recognition Incentive Compensation. EMPLOYEE may earn Coaching Recognition Incentive Compensation for receiving the following recognition. Coaching Recognition Incentive Compensation, if payable, shall be considered earned as of the first date any of the listed honors is named and shall be paid within 60 days of that date. The maximum amount of Coaching Recognition Incentive Compensation payable in a contract year shall be \$52,500.

1. SEC Coach of the Year \$15,000
2. National Coach of the Year (as named by USTFCCA) \$20,000

EMPLOYEE shall earn the full amount of the Coaching Recognition Incentive Compensation for one gender and one-half the amount for the other gender if named for both genders.

C. Academic Incentive Compensation. In the event the multi-year Academic Performance Rate “APR” (as defined by the NCAA) for the Program is the minimum APR multi-year score established by the NCAA (current minimum score is 930) in any one contract year, LSU agrees to pay EMPLOYEE Academic

Incentive Compensation in the amount of \$10,000 for that contract year. Academic Incentive Compensation may only be achieved once per year for the men's team and once per year for the women's team. Academic Incentive Compensation shall be considered earned on the date on which the APR for LSU is released and shall be paid within 60 days of such date. To be eligible for such compensation, EMPLOYEE must be employed by LSU as of the date on which the incentives are earned.

3. **Liquidated Damages for Termination by LSU Without Cause.** Pursuant to Section 11(B)(1) of the Agreement, if LSU terminates Employment during the Term without cause, LSU will pay EMPLOYEE liquidated damages in the amount of Base Salary and Supplemental Compensation which would have been payable to EMPLOYEE for the unexpired Term.
4. **Liquidated Damages for Termination by EMPLOYEE Without Cause.** Pursuant to Section 11(C)(2) of the Agreement, if EMPLOYEE terminates Employment during the Term, EMPLOYEE will pay LSU liquidated damages of 15 percent of the Base Salary which would have been payable to EMPLOYEE for the remaining Term.
5. **Supplemental Provisions.**
 - A. EMPLOYEE shall be entitled to the following additional benefits:
 1. An automobile entitlement of (1) an annual automobile allowance in an amount not to exceed \$1,000 per month, or (2) to the extent consistent with state ethics law, use of courtesy vehicle provided by a dealership and related automobile insurance.
 2. Membership in a country club, such as the University Club of Baton Rouge, provided that: (1) LSU business-related (non-personal) expenses incurred in accordance with LSU and foundation policy will be reimbursed from affiliated foundation funds; and (2) EMPLOYEE shall be responsible for payment of all personal charges and charges unrelated to LSU business.
 3. EMPLOYEE may invite guest(s) for travel to athletic events as per the LSU Travel Handbook. Any guest(s) must be approved for travel on chartered or commercial transportation by the Athletic Director or the Athletic Director's designee.

SIGNATURES ON THE FOLLOWING PAGE

BOARD OF SUPERVISORS OF LOUISIANA
STATE UNIVERSITY AND AGRICULTURAL
AND MECHANICAL COLLEGE

By: _____
William F. Tate, IV, President Date

 10/14/21
Dennis Shaver Date

RECOMMENDED:

Scott Woodward, Director of Athletics

Donna Torres, Interim Executive Vice President for
Finance and Administration/CFO



Board of Supervisors

Request from LSU A&M to Approve Contract for the Head Football Coach

Date: October 29, 2021

1. Bylaw Citation

Pursuant to Article VII, Section 1

- L.3. Appointments and all other personnel actions relating to varsity athletics coaches and Athletic Directors receiving a salary of \$250,000 or above.

2. Summary of the Matter

This resolution seeks approval of the following proposed contract for Edward J. Orgeron, Jr.

Name	Title	Term		Total Certain Compensation ^{a,b}
		Proposed Start Date	Proposed End Date	Proposed
Edward J. Orgeron, Jr.	Head Coach - Football	10/18/2021	12/31/2021	\$500,000

Notes:

- a) Total Certain Compensation includes all compensation which the coach is contractually guaranteed to receive in the first year of the contract. It does not include the value of any fringe benefits, such as car and cell phone allowances, nor any one-time amounts, such as contract buy-outs or relocation allowances.
- b) Base Salary: monthly sum as follows, with partial months prorated:
 - Start Date through November 30th: \$500,000
 - December 1, 2021 through December 31, 2021: \$1,000

3. Review of Business Plan

Not applicable.

4. Fiscal Impact

The Athletic Department currently expects that all funds relating to these employment contracts will be paid from revenues generated by the Athletic Department. While authorized by the contract, it is not expected that any foundation dollars will be needed to provide for any of the supplemental compensation. No state general fund or tuition dollars are used.

5. Description of Competitive Process

Not Applicable



Board of Supervisors

6. Review of Documents Related to Referenced Matter

The Office of General Counsel has reviewed each agreement.

7. Parties of Interest

LSU and the above-named athletics' personnel.

8. Related Transactions

None.

9. Conflicts of Interest

None.

10. Attachments

Contract for Edward J. Orgeron, Jr., Head Football Coach.

RESOLUTION

NOW, THEREFORE, BE IT RESOLVED the Board of Supervisors of Louisiana State University and Agricultural & Mechanical College authorizes William F. Tate, IV, Ph.D., President, or his designee, to execute the position changes for Edward J. Orgeron, Jr. as described in this item, in consultation with the General Counsel.

EMPLOYMENT AGREEMENT

This Employment Agreement (“Agreement”) is made and entered into as of this 19th day of October, 2021, by and between BOARD OF SUPERVISORS OF LOUISIANA STATE UNIVERSITY AND AGRICULTURAL AND MECHANICAL COLLEGE (“LSU”), a body corporate existing under the Constitution and laws of the State of Louisiana, herein represented by William F. Tate, IV, its duly authorized President, and Edward J. Orgeron, Jr. (“EMPLOYEE”):

1. **Definitions.** For purposes of this Agreement, the following terms shall have the meaning shown:
 - A. “President”: The President of LSU.
 - B. “Athletics Director”: The Director of Athletics at LSU.
 - C. “Base Salary”: The monthly sum as follows, with partial months prorated:

Start Date through November 30, 2021:	\$500,000
December 1, 2021 through December 31, 2021:	\$ 1,000
 - D. “Option Period”: If exercised, the period from December 1, 2021 through the end of the last quarter of the post-season bowl game in which the Team participates.
 - E. “Option Salary”: The monthly sum of \$149,000, with partial months prorated.
 - F. “Position”: Head Football Coach of the Team.
 - G. “Start Date”: October 18, 2021.
 - H. “End Date”: December 31, 2021.
 - I. “Program”: The intercollegiate football program at LSU Baton Rouge.
 - J. “Team”: The intercollegiate athletic team which is a part of the Program.
2. **Term.** The term (“Term”) of this Agreement shall be for a definite term, commencing on the Start Date and ending on the End Date unless terminated sooner in accordance with Section 9 of this Agreement.
3. **Employment.** LSU does hereby employ EMPLOYEE in the Position for the Term. EMPLOYEE will report directly to the Athletics Director. It is the goal of the parties that EMPLOYEE will serve in such position throughout the Term of this Agreement and will devote attention on a full-time basis to the duties described in this Agreement; however, LSU shall have the right to reassign EMPLOYEE, without cause and upon written notice to EMPLOYEE, to a non-coach position at LSU that does not require the performance of services on campus or the continuation of his current duties related to the Program.

4. **Post-Season Option.** LSU shall have the option to have EMPLOYEE coach the Team in a post-season bowl game. In the event that the Team accepts a post-season bowl bid, and LSU exercises the option to request that EMPLOYEE coach the Team in the post-season bowl game, EMPLOYEE shall receive the Option Salary for the Option Period and Post-Season Incentive Compensation in the amount of \$25,000. Post-Season Incentive Compensation is additional compensation for the extra services required of EMPLOYEE in the preparation for and participation in post-season play and, if payable, shall be paid within 60 days following the final post-season game in which Team participates. If EMPLOYEE does not actively coach the Team in the Position at the post-season bowl game for any reason, EMPLOYEE shall not be entitled to Post-Season Incentive Compensation.

5. **Duties and Responsibilities.** EMPLOYEE's duties and responsibilities shall include the following, all subject to law, LSU policy, and the directives, input, and advice of the President and the Athletics Director:
 - A. Administering, managing, and leading the Program in a professionally appropriate and competent manner which allows the Team to effectively compete in the football classification generally known as the Power Five, within National Collegiate Athletic Association ("NCAA") play;
 - B. Hiring and firing (subject to appropriate budget approvals, such approvals not to be unreasonably withheld or delayed) and managing the assistant coaches and other athletic staff necessary and appropriate to assist EMPLOYEE in meeting the responsibilities herein;
 - C. Performing all duties reasonably assigned to EMPLOYEE by the Athletics Director so long as such duties are consistent with those duties typically assigned to Head Coaches at colleges or universities at the same competitive level as LSU;
 - D. Promoting and monitoring the success of the Team and its student-athletes both athletically and academically;
 - E. Directing the Team, including management of staff, budget, and other resources;
 - F. Understanding and agreeing that EMPLOYEE and EMPLOYEE's staff, with the reasonable assistance of LSU, are bound by and must be reasonably knowledgeable of and comply with: (1) all applicable federal and state laws governing intercollegiate athletics; and (2) all governing constitutions, by-laws, rules, policies, interpretations, and regulations of the NCAA, the Southeastern Conference ("SEC") and/or LSU (hereinafter collectively referred to as "Governing Athletics Regulations");
 - G. Promptly reporting any known or reasonably suspected violation of Governing Athletics Regulations to the Athletics Director and the Director of Compliance;
 - H. Understanding and complying with Title IX of the Education Amendments of 1972 and LSU policies on Title IX and sexual misconduct, including but not limited to

Permanent Memorandum 73 (“PM-73”) and, as a Responsible Person under PM-73, understanding and complying with the obligation to report incidents of sexual misconduct (including sexual harassment and sexual violence) and other inappropriate sexual conduct of which EMPLOYEE has knowledge or receives notice to LSU’s Title IX Coordinator and other appropriate designee as required by PM-73;

- I. Understanding and complying with Title VI of the Civil Rights Act of 1964, other federal laws, state law, and LSU policies on equal opportunity and discrimination, including, but not limited to, Permanent Memorandum 55;
- J. Cooperating fully in any investigation of possible violations of any Governing Athletics Regulations conducted or authorized by LSU, the SEC, or the NCAA at any time, and cooperating fully in any LSU internal investigation or inquiry;
- K. Reasonably observing, respecting, and promoting the principles of institutional control in the Program;
- L. Reasonably understanding, observing, upholding, and promoting LSU’s written academic standards, requirements, and policies, and reasonably promoting an environment in which admissions, financial aid, academic services for student-athletes, and recruiting can be conducted consistent with LSU’s mission;
- M. Cultivating and maintaining reasonable interaction with the Board of Supervisors, affiliated foundations, athletic conferences, institutional alumni, the media, the public, students, faculty, staff and other members of the LSU community, in accordance with the policies and instructions of the Athletics Director;
- N. Performing all duties in a manner consistent with good sportsmanship and in accordance with the high moral, ethical, and academic standards of the Department of Athletics and LSU;
- O. Using reasonable efforts, through due care and supervision, to ensure that all student-athletes and other individuals under or subject to EMPLOYEE’s control, authority, or supervision comply with all Governing Athletics Regulations and act in accordance with the high moral, ethical, and academic standards of the Program and LSU;
- P. Using reasonable efforts to promote the goal of LSU that every student-athlete obtains an undergraduate degree, and reasonably cooperating with academic counselors or similar persons designated by LSU to assist student-athletes and the faculty and administrators of LSU in connection with the academic pursuits of student-athletes;
- Q. Understanding and complying with NCAA Bylaw 11.1.1.1, which provides: “An institution’s head coach is presumed to be responsible for the actions of all institutional staff members who report, directly or indirectly, to the head coach. An institution’s head coach shall promote an atmosphere of compliance within his or

her program and shall monitor the activities of all institutional staff members involved with the program who report, directly or indirectly, to the coach;" and

- R. Performing all other reasonable duties customarily performed by head football coaches serving at colleges or universities that compete in the NCAA Power Five or at the same competitive level as LSU.
6. **Base Salary.** LSU agrees to pay EMPLOYEE the Base Salary on a monthly basis, with partial months prorated, for the Term.
7. **Retirement and Fringe Benefits.** For the Term, EMPLOYEE shall be entitled to the following benefits, part of which may be paid from affiliated foundation funds:
- A. Retirement and fringe benefit programs available to all unclassified professional LSU employees, with contributions and benefit amounts as defined by law. EMPLOYEE understands and agrees that no contributions for purposes of any State of Louisiana retirement program will be made by LSU or withheld from EMPLOYEE's compensation except as to the Base Salary and any earned Post-Season Incentive Compensation, and EMPLOYEE shall not be entitled to any retirement benefits that may otherwise be attributable to any other compensation paid pursuant to this Agreement. Retirement contributions are subject to the limitations of federal law and Louisiana law.
 - B. Tickets to home, away and postseason contests for football and other sports, subject to existing LSU regulations and policies.
 - C. Membership(s) in a social club, such as the University Club of Baton Rouge, provided that: (i) LSU business-related (non-personal) expenses incurred in accordance with LSU and foundation policy will be reimbursed from affiliated foundation funds; and (ii) EMPLOYEE shall be responsible for payment of all personal charges and charges unrelated to LSU business. Notwithstanding the foregoing EMPLOYEE shall not be personally responsible for expenses authorized and incurred by EMPLOYEE and EMPLOYEE's staff in connection with the ordinary functions associated with an intercollegiate football program, and in accordance with LSU policy.
 - D. Mobile communications device and service for business purposes.
 - E. The opportunity to invite guest(s) for travel to athletic events on chartered commercial transportation subject to approval by the Athletics Director.
 - F. An automobile entitlement of (1) an annual automobile allowance in an amount not to exceed \$2,000 per month or, to the extent consistent with state ethics law, use of two courtesy vehicles provided by a dealership; and (2) related automobile insurance.
 - G. As part of any third-party apparel and/or equipment related contract with LSU, EMPLOYEE acknowledges and agrees that Team may be provided and/or

allocated apparel and/or equipment from and by LSU, which apparel and equipment shall be used in conjunction with all LSU and team-related activities, including LSU-related promotional, broadcast, media and appearance activities.

8. Additional Revenue.

- A. Subject to compliance with Governing Athletics Regulations, including but not limited to current NCAA Bylaw 11.2.2 and 11.3.2, and LSU Permanent Memorandum 11 (“PM-11”), EMPLOYEE may earn or receive other revenue (“Additional Revenue”) while employed by LSU, including working with sports camps or clinics, provided, however, that EMPLOYEE shall obtain prior written approval from the Athletics Director before engaging in any commercial or private venture, including the use of EMPLOYEE’s name by any commercial, public or private entity, which approval shall not be unreasonably withheld or delayed. EMPLOYEE shall report annually to the President and the Athletics Director, in writing, in compliance with NCAA Bylaws 11.2.2, 11.3.2.1, and 11.3.2.1.1, and any applicable LSU policy, all athletically-related income or benefits received by EMPLOYEE from sources outside LSU, and LSU shall have reasonable access to all records of EMPLOYEE to verify this report. LSU does not guarantee any amount of Additional Revenue.
- B. Without the prior written approval of the Athletics Director, EMPLOYEE shall not appear on, or in, any radio, television, or internet programs or other electronic medium other than those produced or sponsored by LSU, or appear in or make any advertisement or make any commercial endorsement. No approval is required for routine news media interviews for which no compensation is received.

9. Termination and Suspension.

- A. **Termination by LSU for Cause.** This Agreement may be terminated for “cause” by LSU, acting through the President, at any time prior to its expiration, upon written notice to EMPLOYEE. With respect to any “termination for cause,” LSU acknowledges that it is not its intent to terminate EMPLOYEE “for cause: for minor, technical or otherwise immaterial violations.”
 - 1. For purposes of this Section, “cause” for termination shall be defined particularly but not exclusively as:
 - a. Committing a material and substantial violation (including repeated lesser violations) of Governing Athletics Regulations; failing promptly to report any such violation by another person to the Director of Compliance; or committing a material and substantial violation of any LSU policies, rules, or procedures that are within the scope and/or meet the definition of Governing Athletics Regulations;
 - b. Committing a material and substantial violation of Governing Athletics Regulations involving any aspect of the Program by any

other person if either: (i) the violation occurs or continues to occur after EMPLOYEE knew or had constructive knowledge that it was about to occur or was occurring, or (ii) EMPLOYEE failed to establish and maintain reasonable policies and procedures, or to follow reasonable policies and procedures established in writing by the Athletic Department for the Program to prevent violations of Governing Athletics Regulations from occurring and to detect promptly any such violations which may occur;

- c. Committing or being convicted of either: (i) any felony, or (ii) any misdemeanor involving gambling, drugs, or alcohol;
- d. Engaging in serious misconduct which either: (i) displays a continual, serious disrespect or continual, serious disregard for the mission of LSU; (ii) brings EMPLOYEE into substantial public disrepute sufficient to materially impair EMPLOYEE's ability to perform the obligations contained herein without material adverse impact on the Team or Program; or (iii) constitutes moral turpitude or breaches the high moral and ethical standards applicable to EMPLOYEE as a visible representative of LSU, including but not limited to, acts of dishonesty, misrepresentation, fraud, or violence that may or may not rise to level of warranting criminal prosecution by the relevant authorities;
- e. Unreasonable refusal or repeated failure to perform any duties imposed upon EMPLOYEE herein (including, but not limited to, those duties specified in this Agreement), or failing to perform the same to the best of EMPLOYEE's reasonable ability;
- f. Prolonged absence from LSU without consent, which will not be unreasonably withheld;
- g. Committing fraud in the performance of any duties and responsibilities herein, either with intent or reckless disregard for the truth, including but not limited to fraud or dishonesty in any written or verbal statements, including résumés, provided by EMPLOYEE to LSU in the application process or fraud in the preparation, falsification, or alteration of documents or records of LSU, the NCAA, or the SEC, or documents or records pertaining to any recruit or student athlete, including without limitation transcripts, eligibility forms, and compliance reports; or knowingly permitting any other person to commit such fraud;
- h. Failure to respond reasonably accurately and fully within a reasonable time to any reasonable requests or inquiry relating to the performance of any duties herein or at any prior employment at any other institution of higher learning propounded by LSU, the NCAA,

the SEC or any other governing body having supervision over the athletic programs of LSU or such other institution of higher education, or required by law or Governing Athletics Regulations; or knowingly permitting any other person to fail to so respond;

- i. Participation in any gambling, bookmaking, wagering, or betting involving any athletic contest whether by soliciting, placing, or accepting a bet or wager or through a bookmaker, a pool, or any other method of gambling; or knowingly permitting any student athlete or other individual under EMPLOYEE's control, authority, or supervision to participate in such activity;
- j. Providing information or data, other than information or data provided to the general public through public presentation, relating in any manner to any intercollegiate sport or to any student athlete to any individual whom EMPLOYEE knows (or has constructive knowledge) to be a gambler, better, or bookmaker, or an agent of any such person; or knowingly permitting any student athlete or other individual under EMPLOYEE's control, authority, or supervision to furnish such information or data;
- k. Use or consumption of alcoholic beverages or controlled substances, steroids, or other drugs or chemicals to such degree and for such appreciable period as to substantially impair EMPLOYEE's ability to perform the duties herein;
- l. Sale, purchase, use or possession of any controlled substances, steroids, or other drugs or chemicals, the sale, purchase, use, or possession of which by EMPLOYEE is prohibited by law or Governing Athletics Rules. The provisions of this subsection do not prohibit the use or possession of substances or drugs lawfully prescribed by a healthcare provider, and used in accordance therewith.
- m. Knowingly encouraging or allowing the sale, purchase, use, or possession by any student athlete or other individual under EMPLOYEE's control, authority, or supervision of any controlled substances, steroids, or other drugs or chemicals, the sale, purchase, use, or possession of which by such person is prohibited by law or Governing Athletics Rules;
- n. Failing reasonably to cooperate in the investigation and enforcement of Governing Athletics Regulations or in any LSU internal investigation or inquiry; or knowingly permitting any other person to fail to cooperate in such investigation and enforcement;

- o. Subject to any right of administrative appeal permitted or granted to EMPLOYEE by the NCAA or SEC, any finding or determination by the NCAA, SEC, or any commission, committee, council, or tribunal of the same, of any major or repetitive violations by EMPLOYEE of NCAA or SEC rules, or of any such major or repetitive violations by others under the direct supervision of EMPLOYEE which were knowingly and intentionally permitted, encouraged, or condoned by EMPLOYEE, or about which violations EMPLOYEE knew or should have known and should have acted reasonably to prevent, limit, or mitigate (it is recognized that this subsection includes findings or determinations of violations during employment of EMPLOYEE at any other institution of higher education);
 - p. Failing to report promptly to the Director of Compliance any violations of Governing Athletics Regulations involving the Team of which EMPLOYEE has actual knowledge;
 - q. Failure by EMPLOYEE to engage in, and use best efforts to ensure that personnel under EMPLOYEE's direct or indirect supervision engage in, safe and responsible treatment of student athletes on the Team, including without limitation failure to comply with any requirement pertaining to medical clearance for participation, or any other act or omission (including but not limited to physical and/or emotional abuse of student athletes) that creates, or could reasonably be expected to create, an unreasonable risk of harm to a student athlete;
 - r. Failure to comply with LSU policies, rules and regulations concerning Title IX, including specifically but not exclusively the reporting of any incident of sexual misconduct in accordance with LSU's Title IX policy and PM-73; or
 - s. Knowingly committing material violation(s) of the terms of this Agreement after failing to cure such violations within five (5) days' written notice of such violation.
2. In the event of termination for cause, EMPLOYEE's Base Salary, Fringe Benefits and all other compensation and benefits provided for in this Agreement shall terminate on the termination date, and LSU shall not thereafter be liable to EMPLOYEE for any sums or damages other than compensation and benefits earned, due, vested or accrued prior to the termination date. The termination date shall be the date on which the initial notice of termination is given, or on such later date as may be set forth by LSU in the notice of termination.

3. Prior to termination for cause, EMPLOYEE shall be provided with written notice of contemplated termination and a statement of the grounds and facts in support thereof and shall have two calendar days from receipt of such notice to respond in writing and/or present documents or other written evidence to the Athletics Director. After review of any such response, the Athletics Director or the Athletics Director's designee shall provide EMPLOYEE written notice of a decision, which will be final.
4. As required by NCAA Bylaw 11.2.1, EMPLOYEE is hereby notified that in addition to the actions LSU may take in accordance with this Agreement, EMPLOYEE is also subject to disciplinary or corrective action as set forth in the provisions of the NCAA enforcement procedures if EMPLOYEE is found by the NCAA or LSU to be in violation of NCAA Bylaws. EMPLOYEE agrees that LSU shall implement any such disciplinary or corrective actions imposed by the NCAA. EMPLOYEE further understands that EMPLOYEE has an affirmative obligation to cooperate fully in the NCAA infractions process, including the investigation and adjudication of a case, pursuant to this Agreement and NCAA Bylaw 11.2.1, and that such obligation continues in effect during and beyond the termination of this Agreement for any violations alleged to have occurred during EMPLOYEE's employment by LSU.

B. Termination by EMPLOYEE Without Cause.

1. EMPLOYEE shall have the right to terminate this Agreement without cause upon written notice to LSU. In the event EMPLOYEE terminates this Agreement without cause, EMPLOYEE will pay LSU liquidated damages, in lieu of any and all other legal remedies or equitable relief. In the event of termination by EMPLOYEE without cause, EMPLOYEE's Base Salary, Fringe Benefits, and all other compensation and benefits provided for in this Agreement shall terminate on the termination date, which, unless otherwise agreed to in writing by LSU and EMPLOYEE, shall be the earlier of: (a) the date on which EMPLOYEE provides notice of termination to LSU; (b) the date on which EMPLOYEE accepts employment from another employer; or (c) the date on which EMPLOYEE performs any work or services of any kind or nature whatsoever on behalf of or for the benefit of another employer. LSU shall not thereafter be liable to EMPLOYEE for any sums or damages other than any compensation earned pursuant to this Agreement prior to the termination date. The Parties acknowledge that this provision is intended to obligate EMPLOYEE to repay unearned compensation and fees previously received under the premise that EMPLOYEE would fulfill the Term of this Agreement.
2. If EMPLOYEE terminates employment at any time before the End Date, EMPLOYEE will pay to LSU as liquidated damages in the amount of Base Salary which would have been payable to EMPLOYEE through the remaining Term of the Agreement. Such liquidated damages may be waived

in the sole discretion of the President if EMPLOYEE is not in breach of this Agreement and the waiver would be in the best interests of LSU.

3. EMPLOYEE shall have the option to pay such amount in a lump sum or in equal monthly installments over a period of time equal to the amount of time then remaining in the Agreement.
4. The parties have bargained for this liquidated damages provision giving consideration to the following. This is an agreement for personal services. The parties recognize that termination of this Agreement by EMPLOYEE prior to its expiration by lapse of term would cause LSU to incur administrative, recruiting, and resettlement costs in obtaining a replacement coach for Team, in addition to potentially increased compensation costs and loss of ticket revenues, which damages are impossible to determine with any certainty.

C. Suspension or Other Disciplinary Action.

1. In lieu of termination for cause, and apart from any rights it may have under this Agreement, LSU may impose disciplinary sanctions less severe than termination upon EMPLOYEE, up to and including suspension or leave without pay for a period no longer than 90 days for any act or omission which would be grounds for discipline or termination for cause. Imposition of such sanctions shall be at the discretion of LSU, which shall not be exercised arbitrarily or capriciously. Prior to suspension without pay under this provision, EMPLOYEE shall be provided written notice of the grounds for the suspension and shall have five calendar days from receipt of such notice to respond in writing to the Athletics Director. After review of any such response, the Athletics Director or the Athletics Director's designee(s) will provide EMPLOYEE with written notice of a decision and/or suspension.
2. Upon written notice and after reasonable opportunity to respond in writing, LSU may suspend EMPLOYEE for an indefinite period during any investigation by LSU, another governmental entity, or the NCAA or SEC to determine whether EMPLOYEE has violated any laws or Governing Athletics Regulations. During such suspension, EMPLOYEE shall receive only the Base Salary and any compensation earned but not yet paid as of the date of the suspension, along with fringe benefits, and shall not be entitled to receive any other benefits, compensation or remuneration set forth in this Agreement for the period of such suspension. If the matter giving rise to the suspension is finally resolved completely in favor of EMPLOYEE, and does not otherwise represent an independent basis for termination herein for cause, LSU shall pay or make available to EMPLOYEE the benefits and other compensation herein otherwise payable to EMPLOYEE during the period of suspension. Any such benefits which are payable pursuant to this Agreement by an affiliated foundation shall only be paid by such

foundation, subject to its approval. Suspension under this subsection shall not limit any rights of LSU to terminate EMPLOYEE for cause.

3. EMPLOYEE shall be subject to disciplinary or corrective action by the NCAA or SEC for any violation of NCAA and SEC regulations, respectively. Such action by the NCAA or the SEC shall not preclude or in any manner affect LSU's right to take such other corrective or disciplinary action as it deems necessary or proper, including termination for cause.
4. Notwithstanding any other provision of this Agreement to the contrary, if EMPLOYEE is suspended by the SEC or NCAA, EMPLOYEE shall automatically be suspended by LSU for the duration of the SEC or NCAA imposed suspension without further notice or process. During such suspension, EMPLOYEE shall not be entitled to receive any compensation, benefits or any other payments under this Agreement except for fringe benefits.

D. **Waiver of Claims.** The financial consequences of termination of this Agreement or suspension herein are exclusively set forth herein. Therefore, with the sole exception of payments required by this Agreement and those prescribed by the Termination Agreement effective as of October 18, 2021 (the "Termination Agreement"), in any instance of termination for cause or without cause, or suspension or other disciplinary sanction effected in accordance with the procedures established in this Agreement, neither EMPLOYEE nor LSU shall be entitled to receive, and each hereby waives any claim against the other, and their respective board members, officers, directors, agents, employees, successors, and personal representatives for consequential damages by reason of any alleged economic loss, including without limitation loss of collateral income, deferred income, loss of earning capacity, loss of business opportunity, loss of perquisites, loss of fees from speaking, camps or other outside activity, or damages allegedly sustained by reason of alleged humiliation or defamation or other non-compensatory and compensatory damages and attorney's fees resulting from the fact of termination, the public announcement thereof, or the release by LSU or EMPLOYEE of information or documents required by law. EMPLOYEE acknowledges that in the event of either termination of this Agreement for cause, without cause, or otherwise, or suspension or other disciplinary sanction effected in accordance with the procedures established in this Agreement, EMPLOYEE shall have no right to occupy the Position and that EMPLOYEE's sole remedies are provided herein and shall not extend to injunctive relief. EMPLOYEE further acknowledges and agrees that EMPLOYEE is not eligible for and will not be considered for or granted tenure by LSU.

10. **Retention and Return of all Materials, Records, and Other Items.** All documents, records, or materials, including without limitation personnel records, recruiting records, team information, films, statistics, or any other material or data furnished to EMPLOYEE by LSU or developed by EMPLOYEE on behalf of or at the expense of LSU or otherwise in connection with the employment of EMPLOYEE are and shall remain the sole and

confidential property of LSU. Within 10 days of the expiration or termination of this Agreement, EMPLOYEE shall cause any such materials in EMPLOYEE's possession or control to be delivered to LSU. At the same time, EMPLOYEE shall return to LSU all credit cards, keys, computers, automobiles, mobile communication devices and other items belonging to LSU which were issued to or are in the possession of EMPLOYEE.

11. Leave and Overtime.

- A. **No Annual Leave.** Because of the specific nature of EMPLOYEE's job duties and the irregular times during which EMPLOYEE will be required to perform those job duties, EMPLOYEE acknowledges and agrees that EMPLOYEE will not earn or accrue annual leave. EMPLOYEE's Base Salary has been mutually negotiated with this understanding, and both EMPLOYEE and LSU agree that the Base Salary would be less if EMPLOYEE were entitled to earn annual leave.
- B. **No Overtime.** EMPLOYEE qualifies and is designated as exempt under the Fair Labor Standards Act and is not entitled to any overtime pay or compensatory leave for work in excess of 40 hours in any workweek.
- C. **Sick Leave.** EMPLOYEE will accrue and use sick leave in accordance with LSU policy.

12. Non-Assignment. None of the parties to this Agreement may assign, transfer, alienate, or encumber any of its rights or obligations hereunder without the express written consent of the other parties, except as otherwise specifically set forth in this Agreement.

13. Entire Agreement. This Agreement constitute and express the entire agreement and understanding of the parties concerning the subject matter hereof beginning on the Effective Date. There are no oral or other agreements, understandings, promises, or representations between the parties affecting this Agreement. Both parties have relied solely on their own respective judgments in entering into this Agreement, with full opportunity to seek advice of competent counsel. The Agreement shall be construed, if necessary, without reference to the party that was the principal drafter of the Agreement.

14. Indirect Actions Prohibited. Any act which EMPLOYEE is prohibited from doing directly in this Agreement may not be done indirectly by EMPLOYEE or another person on EMPLOYEE's behalf or at EMPLOYEE's behest.

15. Amendments to Agreement. This Agreement may be amended only by a written instrument duly approved by LSU through its designated representatives and accepted by EMPLOYEE, such approval and acceptance to be acknowledged in writing.

16. Severability. If any provision of this Agreement shall be deemed invalid or unenforceable, either in whole or in part, this Agreement shall be deemed amended to delete or modify, as necessary, the offending provision or to alter the bounds thereof in order to render it valid and enforceable.

17. **No Waiver of Default.** No waiver by the parties hereto of any default or breach of any covenant, term or condition of this Agreement shall be deemed to be a waiver of any other default or breach of the same or any other covenant, term or condition contained herein.
18. **No Waiver of Sovereign Immunity.** It is expressly agreed and understood between the parties that nothing contained herein shall be construed to constitute a waiver or relinquishment by LSU of any rights to claim such exemptions, privileges and immunities as may be provided by law.
19. **“Force Majeure” Clause.** Neither party shall be considered in default of performance of any obligations under this Agreement if such performance is prevented or delayed by Force Majeure. “Force Majeure” shall be understood to be any cause which is beyond the reasonable control of the party affected and which is forthwith, by notice from the party affected, brought to the attention of the other party, including but not limited to war, hostilities, revolution, civil commotion, strike, lockout, epidemic, accident, fire, natural disaster, wind or flood or any requirements of law, or an act of God.
20. **Governing Law and Venue.** This Agreement shall be enforced and construed in accordance with the laws of Louisiana. Any civil action to enforce this Agreement shall be brought in a state or federal court having jurisdiction and domiciled in East Baton Rouge Parish, Louisiana.

THE PARTIES hereto, acknowledging that this Agreement is subject to approval of the Board of Supervisors, have executed this Agreement on the day, month and year first above written.

BOARD OF SUPERVISORS OF LOUISIANA
STATE UNIVERSITY AND AGRICULTURAL
AND MECHANICAL COLLEGE

By: _____
William F. Tate, IV, President Date

EMPLOYEE:

Edward J. Orgeron, Jr. Oct 25, 2021
Edward J. Orgeron, Jr. Date

RECOMMENDED:

Scott Woodward
Scott Woodward, Director of Athletics

Donna Torres
Donna Torres, Interim Executive Vice President
for Finance and Administration/CFO



Board of Supervisors

Request from LSU A&M to Approve Termination Agreement for the Head Football Coach

Date: October 29, 2021

1. Bylaw Citation

Pursuant to Article VII, Section 1

- L.3. Appointments and all other personnel actions relating to varsity athletics coaches and Athletic Directors receiving a salary of \$250,000 or above.

2. Summary of the Matter

This resolution seeks approval of the following proposed termination agreement for Edward J. Orgeron, Jr.

Name	Title	Term
		Proposed End Date
Edward J. Orgeron, Jr.	Head Football Coach	10/18/2021

3. Review of Business Plan

Not applicable.

4. Fiscal Impact

The Athletic Department currently expects that all funds relating to these employment contracts will be paid from revenues generated by the Athletic Department. While authorized by the contract, it is not expected that any foundation dollars will be needed to provide for any of the supplemental compensation. No state general fund or tuition dollars are used.

5. Description of Competitive Process

N/A

6. Review of Documents Related to Referenced Matter

The Office of General Counsel has reviewed each agreement.

7. Parties of Interest

LSU and the above-named athletics' personnel.

8. Related Transactions

None.



Board of Supervisors

9. Conflicts of Interest

None.

10. Attachments

Contract for Edward J. Orgeron, Jr., Head Football Coach

RESOLUTION

NOW, THEREFORE, BE IT RESOLVED the Board of Supervisors of Louisiana State University and Agricultural & Mechanical College authorizes William F. Tate, IV, Ph.D., President, or his designee, to execute the position changes for Edward J. Orgeron, Jr. as described in this item, in consultation with the General Counsel.

TERMINATION AGREEMENT

This Termination Agreement (“Agreement”), effective October 18, 2021 (“Effective Date”), is between the Board of Supervisors for Louisiana State University and Agricultural and Mechanical College (“LSU” or “University”), Edward J. Orgeron, Jr. (“Employee”) and My 3 Tiger Boyz LLC (“Company”) (collectively, the “Parties”).

WHEREAS, the Parties entered into an Employment Agreement dated April 23, 2020 (“2020 Employment Agreement”), which provides the terms of the Employee’s employment and Company’s engagement through December 31, 2025;

WHEREAS, the University intends to terminate the 2020 Employment Agreement without cause pursuant to the terms herein;

WHEREAS, the University will continue to employ Employee in a limited capacity for the remainder of the 2021 LSU Football Season, which engagement will be provided for in a separate agreement;

NOW, THEREFORE, exclusively in lieu of payments or wages for future coaching services for the University, and in consideration of the mutual promises and covenants contained herein, the parties agree as follows:

1. **Term.** The term (“Term”) of this Agreement shall be from the Effective Date through December 31, 2025.

2. **Termination of Employment.** Employee’s employment and Company’s engagement under the 2020 Employment Agreement shall terminate on the Effective Date. Employee will be compensated for the current month under the 2020 Employment Agreement prorated to the Effective Date.

3. **Termination Payments.** In exchange for the execution of this Agreement and acceptance of all terms, and in lieu of payments for his future personal services as head football coach for the University, LSU agrees to the payments in the amounts and on or before the dates designated below in full and final settlement of any and all obligations between the Parties under the 2020 Employment Agreement. Payments directly to Employee are subject to all applicable payroll taxes and deductions.

a. **Payments to Employee:**

December 15, 2021:	\$5,000,000
June 15, 2022:	\$1,000,000
December 15, 2022:	\$1,000,000
June 15, 2023:	\$ 750,000
December 15, 2023:	\$ 750,000

June 15, 2024:	\$ 500,000
December 15, 2024:	\$ 500,000
June 15, 2025:	\$ 426,000
December 15, 2025:	\$ 426,000

b. Payments to Company:

January 15, 2022:	\$ 667,000
July 15, 2022:	\$ 750,000
January 15, 2023:	\$ 750,000
July 15, 2023:	\$ 750,000
January 15, 2024:	\$ 750,000
July 15, 2024:	\$ 750,000
January 15, 2025:	\$ 750,000
July 15, 2025:	\$ 750,000

c. Payment to UbieKauf, LLC:

December 15, 2021:	\$ 680,000
--------------------	------------

4. **Additional Consideration.** As further consideration for this Agreement, Employee agrees to the following:

a. **Personal Appearances.** During the Term and subject to his personal and professional availability, Employee will make at least one local public appearance on behalf the LSU athletics program per year (beginning in calendar year 2022) upon request of the University, which shall not exceed two (2) hours in duration unless otherwise agreed in writing between the parties. The obligation is for a total of four appearances. If Employee is unable to complete an appearance within a calendar year, the obligation shall accrue to the following calendar year.

b. **License of Name and Likeness.** During the Term, Employee hereby grants University an irrevocable, non-exclusive, non-assignable, non-transferrable worldwide limited license to use Employee's name and approved likeness in media, advertising and promotional materials in support of the LSU athletics program in a non-commercial capacity. Any media, advertising or promotional materials depicting the image of Employee shall require approval of Employee, which approval shall be in his sole discretion.

- c. **Restrictive Covenant.** For a period of 18 months from the Effective Date, Employee agrees that he will not become employed as or serve in a head coach capacity for any collegiate football team or program in the Southeastern Conference as constituted as of the Effective Date. The geographic boundaries of the restriction contemplated by this Section include all municipalities, counties and parishes of each institution affiliated with the Southeastern Conference with a collegiate football program.
- d. **Continued Employment by Employee.** On October 19, 2021, Employee will commence employment with LSU under a new employment agreement to be executed contemporaneously with this Agreement. It is the intention of the parties that there be no interruption of service.
5. **Mutual Release.**
- a. Except for the obligations arising out of this Agreement, the Employee, himself and on behalf of his agents, heirs, beneficiaries, successors and assigns, past or present, and the Company (collectively the "Employee Parties") do hereby release, acquit, satisfy and forever discharge LSU, its agents, board members, employees, successors and assigns (collectively, the "Employer Parties"), from any and all actions, causes of action, claims, rights, debts, sums of monies, costs, expenses, attorneys' fees, judgments, orders and liabilities, accounts, covenants, controversies, promises, damages, of whatever kind and nature in law or equity or otherwise whether now known or unknown (collectively, the "Claims"), which the Employee Parties ever had, now have, or may have had against any of the Employer Parties, for any reason (including, but not limited to, all Claims relating to the 2020 Employment Agreement) from the beginning of time up through and including this date. In furtherance of the foregoing, each of the releasing parties irrevocably covenants to refrain from, directly or indirectly, asserting any Claims, or commencing, instituting or causing to be commenced, any proceeding of any kind against any of the Employer Parties with respect to any of the matters within the scope of the foregoing release.
- b. Except for the obligations arising out of this Agreement, the Employer Parties do hereby release, acquit, satisfy and forever discharge, the Employee Parties, from any and all actions, causes of action, claims, rights, debts, sums of monies, costs, expenses, attorneys' fees, judgments, orders and liabilities, accounts, covenants, controversies, promises, damages, of whatever kind and nature in law or equity or otherwise (collectively, the "Claims"), which the Employer Parties ever had, now have, or may have had against any of the Employee Parties, for any reason (including, but not limited to, all Claims relating to the 2020 Employment Agreement) from the beginning of time up through and including this date. In furtherance of the foregoing, each of the releasing parties irrevocably covenants to refrain from, directly or indirectly, asserting any Claims, or commencing, instituting or causing to be commenced, any proceeding of any kind against any of the Employee Parties with respect to any of the matters within the scope of the foregoing release.

6. **Duty to Cooperate/Indemnification of Employee.** After the Effective Date, Employee agrees, without additional compensation (other than reimbursement for reasonable associated expenses), to cooperate with LSU in any investigation, internal or otherwise, of any possible violation of law (including Title IX) or violation of any rule, policy or regulation of LSU (including PM-73), the Southeastern Conference or the National Collegiate Athletics Association. Employee further agrees (a) to be reasonably available to answer questions regarding any matter with which Employee was involved while employed by LSU, (b) to cooperate with LSU during the course of any proceedings arising out of any matter with which Employee has knowledge or information, and (c) to cooperate in the defense of any litigation in which Employee is named as a defendant or identified as a witness as a result of Employee's employment with LSU, including the matter of *Abby Owens, et al. v. Louisiana State University, et al.* Further, LSU acknowledges and agrees that nothing in this Agreement shall relieve it of its obligations to indemnify Employee for claims brought against Employee and arising within the course and scope of his employment, at any and all times, with LSU, to the extent allowed by law.

7. **Governing Law, Jurisdiction and Venue.** This Agreement shall be enforced and interpreted in accordance with the laws of the State of Louisiana. Any civil action to enforce this Agreement shall be brought in a state or federal court having jurisdiction and domiciled in East Baton Rouge Parish, Louisiana. The parties irrevocably submit to the jurisdiction of the chosen courts, and agree not to assert as a defense in any such action, suit or proceeding that such party is not subject to the jurisdiction of the chosen courts, that such action, proceeding or claim may not be brought or is not maintainable in the chosen courts, that venue is not appropriate in the chosen courts, or that this Agreement may not be enforced in the chosen courts. The prevailing party in litigation under this Section shall be entitled to reasonable attorney's fees.

8. **Tax Liability and Indemnification.** Employee and Company agree that they shall be solely liable for any and all extraordinary taxes which may be due on any payments made under this Termination Agreement. Employee and Company, both individually and collectively, agree that they shall fully indemnify and hold LSU harmless from any tax liability assessed to LSU arising from or related to the timing of the payments made under this Termination Agreement only, including, but not limited to, any taxes, penalties, fines, and/or interest assessed by any tax authority, as well as any attorneys' fees and costs incurred by LSU to enforce this provision. For the avoidance of doubt, the parties acknowledge and agree that LSU shall remain responsible for any and all ordinary and necessary employer taxes or withholdings arising from this Agreement.

9. **Further Assurances.** Each party shall do and perform, or cause to be done and performed, all such further acts and things, and shall execute and deliver all such other agreements, certificates, instruments and documents, as the other party may reasonably request in order to carry out the intent and accomplish the purposes of this Agreement and the consummation of the transactions contemplated hereby.

IN WITNESS WHEREOF, the parties have executed this Termination Agreement as indicated below.

BOARD OF SUPERVISORS OF LOUISIANA
STATE UNIVERSITY AND AGRICULTURAL
AND MECHANICAL COLLEGE

By: _____
William F. Tate, IV, President Date

EMPLOYEE:

 _____ *06/17/2021*
Edward J. Orgeron, Jr. Date

COMPANY:

MY 3 TIGER BOYZ, LLC

By:  _____ *06/17/2021*
Edward J. Orgeron, Jr., Manager Date

RECOMMENDED:



Scott Woodward, Director of Athletics



Board of Supervisors

RISK MANAGEMENT COMMITTEE

BOARD OF SUPERVISORS MEETING | OCTOBER 28-29, 2021

2022 1st Quarter – Supplement

LSU A&M Inventory Management.....	2
HSCNO Clinical Trials.....	12
HSCS Clinical Trials.....	25

EXECUTIVE SUMMARY

Internal Audit completed an audit of Inventory Management from the Board-approved Audit Plan. This audit report provides an evaluation of the controls at LSU A&M for purchasing, safeguarding, and inventorying of unique assets, information technology assets, and sensitive items, as well as an evaluation of the emergency purchase process.

Through our risk assessment process, aided by discussions with management, we selected the following areas for testing: sensitive or unique asset registration; emergency purchases; off-campus asset storage; firearm and ammunition acquisition, storage, and inventory tracking procedures; donated asset reporting; and sensitive asset disposals. During the planning phase, we reviewed applicable laws, regulations, policies, and procedures and met with campus personnel to gain an understanding of controls used in inventory processes of unique, sensitive, or emergency asset acquisitions. The scope of this audit covered purchasing and inventory records for the period July 1, 2019, to November 30, 2020. The purchase of chemicals and biohazard materials was excluded from the scope of this review because these items were addressed during a fiscal year (FY) 2019 multi-campus laboratory safety audit.

We noted processes in place to mitigate the identified risks, such as annual firearm training for University police; restricted vaults, safes, and lockers for weapon storage; emergency purchase procedures; and controls for tracking specific purchases. We also identified areas where controls could be enhanced. Based on testing performed, we have the following recommendations for campus leadership:

- Assess the current spend categories in Workday to identify instances where spend category designations should be changed from non-trackable to trackable, or instances where new trackable spend categories can be created in Workday. Enhance existing controls to ensure all taggable and sensitive assets purchased or donated to the University are readily identified, physically tagged, and promptly recorded in University inventory records.
- LSU A&M Police Department (LSUPD) should develop and implement a process to monitor ammunition inventory and track distributions.
- LSU A&M Property Management should develop a process to retain supporting documentation for sensitive asset disposal requests, approvals, and disposal events. A process should be implemented to ensure all sensitive asset disposals are reviewed and approved by LPAA personnel prior to disposal.

Management agreed with these recommendations and is in the process of implementing the corrective action plans included in Appendix A. We appreciate the assistance provided by LSU A&M Property Management, LSUPD, Procurement Services and Accounting Services personnel during the engagement.

BACKGROUND

Inventory:

The LSU Office of Property Management operates under the Louisiana Property Assistance Agency (LPAA). Property Management monitors and facilitates the management of the University's moveable property inventory and fleet management programs in accordance with regulations established by LA Revised Statute (Titles 39 and 24) and with various federal government regulations when applicable.

LSU Procurement policy POL-U34.307 defines sensitive assets as all items, regardless of value, that require special control and accountability due to unusual rates of loss, theft, or misuse, or due to national security or export control considerations. This includes pistols, rifles, shot guns, tasers, beanbag guns, stun guns, starter pistols, noise suppressors, bulletproof vests, etc. LSU Property Management identifies the purchase of sensitive and taggable assets through the procurement process in Workday, LSU's administrative system for financial, payroll and human resources processes. All purchases are assigned a spend category that is designated as trackable or non-trackable. Items charged to a trackable spend category are assigned an asset ID and reported to LSU Property Management in Workday. LSU Property Management will observe and physically tag these items prior to registering the items as University inventory in Workday.

As a result of the pandemic, Property Management assigned tag numbers and registered assets through email confirmation prior to physically observing each asset. This temporary process was put in place to allow Property Management to certify the 2020 inventory while being limited in ability to observe assets in-person.

Emergency purchases:

An emergency purchase may be made when the existence of an emergency condition creates an immediate and serious need for goods or services that cannot be met through normal procurement methods. Emergency procurements are made using the most competitive process available consistent with the need for responding to the emergency. Reasonable efforts under the circumstances should be made to obtain quotations from three or more vendors when goods or services are to be purchased on an emergency basis. Emergency procurement is limited to only those goods and services necessary to meet the emergency.

LSU Procurement is required to be contacted for approval from the Chief Procurement Officer (Director of Procurement), or their designee, when an emergency condition arises that cannot follow the standard requisition/purchase order process. Written documentation explaining the nature of the emergency must then be signed by the Department Head or the authorized representative and attached to a requisition for the goods or services purchased.

Pandemic purchases and remote assets:

Equipment purchased for or used off-campus requires approval by the Department Property Custodian, Department Head Chair, and LSU Property Manager through the completion of the “Request for off-campus/home storage form”. As a result of the pandemic and the high volume of equipment required for remote work, Property Management is allowing individual departments to report equipment currently being used off-campus in an Excel spreadsheet and obtaining the necessary approvals through email.

SCOPE AND OBJECTIVES

The objectives of this audit included ensuring the following:

- Purchased high risk and sensitive assets were identified, recorded, and tracked
- Emergency purchases were appropriately authorized and included adequate justification
- Off-campus assets received appropriate approvals and were recorded in inventory
- Firearm and ammunition purchases were made in support of University business
- Donated assets were identified and reported to Property Management
- High risk or sensitive assets were adequately safeguarded on and off-campus
- Sensitive asset disposals received appropriate approval and were properly recorded

The scope of our work included purchasing and inventory records for the period 7/1/2019 to 11/30/2020. Procedures included reviews of policies, procedures, and controls; interviews with department personnel; process walkthroughs; analysis of data for all in-scope areas; and review or inspection of other department records. We did not provide assurance on CARES Act compliance. The purchase of chemicals and biohazard materials was also excluded, as these items were addressed during a FY19 multi-campus laboratory safety audit.

Testing methodology is summarized below, by category:

Procurement of High-Risk, Unique, or Emergency Items – Examined the trackable and non-trackable spend categories available in Workday to identify categories where sensitive and high-risk assets may not be reported to Property Management. For a sample of high risk, unique, and emergency purchases, determined if the asset was identified and registered by Property Management into University inventory. See **Finding #1**.

Asset Donation Reporting – Reviewed a sample of donated non-cash assets over \$1,000 in value or of sensitive/unique nature to determine if the assets were reported to Property Management, registered into University inventory, and tagged. See **Finding #1**.

Firearm and Ammunition Purchases – Firearm purchases were reviewed to determine if each firearm was identified as a taggable asset and subsequently included in inventory records. For ammunition purchases, the caliber was identified and compared to firearm inventory lists to determine if the ammunition was compatible with University owned firearms. A sample of police officer inventory packets was reviewed to identify instances of officers being assigned firearms or ammunition in excess of usual assignments. Also, ensured that the firearm(s) assigned to each officer agreed to LSU Police inventory records. See **Finding #2**.

Sensitive Asset Disposals – Reviewed supporting documentation for a sample of asset disposals to ensure adequate Property Management review and submission, with preceding approval from LPAA, and appropriate disposal method based on approvals. See **Finding #3**.

Emergency Purchases – Determined if appropriate personnel approved a sample of emergency purchases and if supporting documentation was available justifying the nature of the emergency. Identified which standard procurement steps were modified or omitted due to emergency purchase status for the selected transactions. No issues noted.

Off-Campus Storage of Assets – Assessed the off-campus storage and tracking processes in place for the pandemic. Testing was not performed due to incomplete population data. The process of identifying off-campus items was still ongoing and the population was incomplete at the time of the audit. Property Management was still working to identify and tag applicable items as transactions were reviewed, and items are being returned to campus. No issues noted.

Sensitive Asset Inventory Storage – Verified the completion of annual firearm safety and storage training for required police officers. In addition, we reconciled LSU Police inventory records of sensitive assets to the University inventory and conducted a site inspection at LSU Police headquarters to evaluate the security of all inventory storage areas. Confirmed the physical existence and location of sampled sensitive items from police inventory records. No issues noted. LSU A&M Track and Field, Aerospace Studies, and the National Center for Biomedical Research and Training (NCBRT) have sensitive assets. These assets were not included in testing due to an apparent lower risk based on the volume and type of sensitive assets.

Procedures that yielded issues are discussed in our recommendations to management. This internal audit activity was conducted in conformance with the *International Standards for the Professional Practice of Internal Auditing* set by the *Institute of Internal Auditors*.

FINDINGS AND RECOMMENDATIONS

Finding No. 1: Unidentified Taggable Items

Purchased and donated assets were not tagged within the required timeframe. We noted the following:

- Three of the ten selected assets were not identified to be tagged. All three of these items were charged to non-trackable spend categories not reported in Workday by LSU Property Management. The spend category for each transaction is selected by the individual departments making the purchases and ultimately determines if a purchase is reported to LSU Property Management.
- Two assets purchased on LaCarte cards were not tagged as of May 14, 2021. During testing, two other LaCarte card purchases were found that were not manually registered in Workday until six months and one year after their respective acquisition dates. LaCarte purchases are individually reviewed by Property Management to identify trackable items. Property Management acknowledged that, as a result of the pandemic, its staff was working through a backlog of assets that need to be reviewed and tagged at the time of the audit.
- Three of the donated assets we reviewed were not tagged and registered into inventory within 60 days of acquisition. Sponsored Program Accounting (SPA) only provides the donations that they are aware of to Property Management for evaluation and tagging. According to Procurement policy POL-U34.307, LSU A&M departments are responsible for reporting donations to SPA. As a result, taggable donations may not be reported or identified as trackable assets if SPA or Property Management are not properly notified.

The current processes allow some taggable items to be missed or not identified. If taggable assets are not identified and registered by the University within the required period of time after acquisition, inventory records and reviews may be inaccurate. The potential for diversion, loss, or misuse of assets increases if assets are not properly recorded into LSU A&M inventory.

Recommendation: Assess the current spend categories in Workday to identify instances where spend category designations should be changed from non-trackable to trackable, or instances where new trackable spend categories can be created in Workday. Enhance existing controls to ensure all taggable and sensitive assets purchased or donated to the University are readily identified, physically tagged, and promptly recorded in University inventory records. Provide additional training or periodic reminders to Asset Custodians for reporting of donated assets to SPA.

Finding No. 2: Ammunition Inventory Procedures

Ammunition is not currently tracked by the LSU A&M Police department when it is provided to officers. Ammunition is distributed on an as-needed basis without the amount, type, or caliber being recorded. Because ammunition inventory procedures do not exist, there is an increased risk or diversion of theft of ammunition going undetected by the University.

Recommendation: LSUPD should develop and implement processes to monitor ammunition inventory and track distributions.

Finding No. 3: Sensitive Asset Disposal Documentation

Five out of the six sampled sensitive asset disposals did not receive proper approval by LPAA personnel due to an issue within the system (AMP) used by the LPAA. Supplemental documentation was provided by LPAA for three out of the six selected assets to verify additional steps were taken by LSU Property Management to obtain approval from LPAA personnel in these instances. Louisiana Administrative Code (LAC) Title 34 Section VII authorizes LPAA to approve disposals of State property. LPAA confirmed that due to a programming issue in AMP during the review period, these disposal requests were auto approved by the Asset Management Platform (AMP) system without being reviewed by an LPAA employee. Per the LPAA, the AMP system is designed to have a flag in place for the Class Codes (Asset Classes in Workday) of sensitive assets to prevent the auto-approval for assets less than \$5,000. The flag for sensitive assets sometimes gets disabled when AMP updates are released. When Property Management discovered the problem in AMP, they notified LPAA, but the issue continued for some time before being fixed. LPAA advised in August 2021 that the issue in AMP has been corrected and it is working properly now. LSU A&M Property Management stated that they would obtain LPAA approval for sensitive asset disposals, even in instances where the disposals were automatically approved in AMP. LSU A&M Property Management was unable to provide supporting documentation for the review and approval of the disposals from department records. The Director of Property Management reached out to LPAA to request records/emails they may have on file supporting LPAA's approval for the sampled disposals. The LPAA provided copies of the approval request emails for three of the six sampled sensitive asset disposals. It is unknown if LSU Property Management requested approval from LPAA outside of the AMP system for the remaining three disposals.

Recommendation: LSU A&M Property Management should develop a process to retain supporting documentation for sensitive asset disposal requests, approvals, and disposal events. A process should be implemented to ensure all sensitive asset disposals are reviewed and approved by LPAA personnel prior to disposal.



DISTRIBUTION LIST

William Tate IV, President

Donna Torres, Interim Executive Vice President for Finance and Administration

Matt Lee, Interim Executive Vice President and Provost

Winston DeCuir, Jr., Vice President of Legal Affairs and General Counsel

Elahe Russell, Associate Vice President for Accounting Services

Sally McKechnie, Assistant Vice President for Procurement and Property Management

Tolliver Bozeman, Director, LSU Property Management

Bart Thompson, LSU Chief of Police

APPENDIX A –
MANAGEMENT'S RESPONSE



Finance & Administration

Date: September 15, 2021

To: Chad Brackin, Chief Auditor
Office of Internal Audit

From: Donna K. Torres, CPA 
Interim Executive Vice President for Finance
and Administration/CFO

Re: Response to LSU A&M 2102A – Inventory Management

Thank you for the opportunity to respond to the draft of the Inventory Management Audit Report. The following sections include responses to the findings and recommendations presented in the report.

Finding No. 1: Unidentified Taggable Items

Recommendation: Assess the current spend categories in Workday to identify instances where spend category designations should be changed from non-trackable to trackable, or instances where new trackable spend categories can be created in Workday. Enhance existing controls to ensure all taggable and sensitive assets purchased or donated to the University are readily identified, physically tagged, and promptly recorded in University inventory records. Provide additional training or periodic reminders to Asset Custodians for reporting of donated assets to SPA.

Response: Management agrees with the recommendation.

Property Management will review existing Spend Categories, identify and make any appropriate changes, including trackable/non-trackable designation or the creation of additional categories, in consultation with representatives from Procurement and other units. Additionally, the workflow of non-cash/in kind donations is already being reviewed for potential changes. Once the future of that process is settled, training materials, websites and other communications will be revised and special emphasis given via key venues (Business Managers meeting, Asset Custodian training, etc.).

Responsible Personnel: Toliver Bozeman, Director of Property Management

Implementation Date for Follow-Up: June 30, 2022

Finding No. 2: Ammunition Inventory Process

Recommendation: LSUPD should develop and implement processes to monitor ammunition inventory and track distributions.

Response: Management agrees with this recommendation.



Finance & Administration

In lieu of the recent audit, LSUPD will implemented a system to track all ammo, to include simmunition rounds that are purchased by the department for departmental use. Now all ammo, even that which has been earmarked for SRT, will be kept inside the armory. The ammo has been separated into sections (SRT vs. General Usage), and ammunition will be kept separate (training, duty, etc.) as previous established.

The procedure will involve the intake or check out, of ammunition, which will be tracked on a separate spread and will remain in the armory.

When the ammunition is received, the receiving armorer will sign in the ammunition in (date and initial), place it on the respective shelf, and will add that new ammunition to the existing total, carrying the new total to the documented spreadsheet.

When the ammunition is checked out, the issuing armorer will sign out the ammo (date and initial), issue it to the officer(s) that will date and initial, and then deduct the issued ammo from the existing total. That new total will then be carried to the documented spreadsheet.

Sgt. Bergeron has implemented this new procedure, July 6, 2021, and has been using it with great success. It has helped track the ammunition while determining the needs. The sheets will be scanned and kept digitally, as well as the original kept in a file in the training office.

Responsible Personnel: Firearms Instructors; Lt. Jeff Melchior / Sgt. C. Bergeron

Implementation Date for Follow-Up: July 6, 2021

Finding No. 3: Sensitive Asset Disposal Documentation

Recommendation: LSU A&M Property Management should develop a process to retain supporting documentation for sensitive asset disposal requests, approvals, and disposal events. A process should be implemented to ensure all sensitive asset disposals are reviewed and approved by LPAA personnel prior to disposal.

Response: Management agrees with this recommendation.

Effective immediately, Property Management will adopt the following process when disposing of sensitive assets:

- a) Obtain written approval from LPAA for the disposal
- b) Dispose the asset in the AMP system and upload a digitized copy of LPAA's approval
- c) Retain a digital copy (PDF) on departmental server, and a hard copy in a dedicated Sensitive Asset Disposal file to be maintained in the Property Management file storage room.
- d) Dispose the asset in Workday

Responsible Personnel: Toliver Bozeman, Director of Property Management

Implementation Date for Follow-Up: June 30, 2022

EXECUTIVE SUMMARY

Internal Audit completed an audit of privately funded clinical trials at LSU Health Sciences Center New Orleans (HSCNO) from the Board-approved Audit Plan. This audit report provides an evaluation of the controls currently in place to mitigate risks related to clinical trial administration, billing, and finance.

Through our risk assessment process, aided by discussions with management at HSCNO, we selected the following areas for testing: authorization of trial documents; participant consent forms; trial personnel training; Institutional Review Board (IRB) and administrative fees; billing and collecting for trial services; participant compensation; and trial closeout procedures. During the planning phase, we reviewed applicable laws, regulations, policies, and procedures and met with personnel at HSCNO to gain an understanding of clinical trial management. The scope of this audit covered private, non-federal sponsored clinical trials that were active or closed during Fiscal Year 2020.

Based on testing performed, we have the following recommendations for HSCNO leadership:

1. Strengthen clinical trial administration controls to ensure:
 - A comprehensive listing of clinical trials is maintained.
 - Fully executed Clinical Trial Agreements (CTAs) are filed in a centralized location.
 - CTAs are fully executed prior to participants receiving services.
 - Conflict of interest records are maintained in accordance with policy.
 - Account reconciliations and closeouts occur pursuant to policy.
2. Implement additional controls to ensure appropriate monitoring of billing and collection of trial fees and revenue in accordance with trial agreements.
3. Enhance controls to ensure clinical trial participants receive compensation as outlined in the CTA and incorrect payment amounts to participants be corrected, when possible, to ensure compliance with the CTA.

Management agreed in part with these recommendations and is in the process of implementing the corrective action plans included in Appendix A. We appreciate the assistance provided by the Office of Research Services, the Sponsored Projects Office, the Office of Compliance Programs, and the School of Medicine personnel during the engagement.

BACKGROUND

A clinical trial is a prospective research study of human subjects designed to answer specific questions about biomedical or behavioral interventions (drugs, treatments, devices, etc.). Clinical trials are used to determine whether new interventions are safe and effective. The administration of clinical trials at HSCNO is decentralized. The management of trials is the shared responsibility of the Office of Research, IRB, Sponsored Projects, the principal investigators (PI), and staff within the PIs’ departments. The decentralized structure has caused administrative and governance issues in the past, addressed in the 2018 HSCNO Clinical Trials audit. During planning interviews, management expressed an interest in creating a central clinical trials office to help alleviate some issues, but the lack of available funding prevents the establishment of the office.

Since the last clinical trials audit was performed in 2018, several policies have been updated or created that have a direct effect on trials. The list of policies and procedures includes: Permanent Memorandum 21 regarding third party involvement with university sponsored projects; Chancellors Memorandum (CM) 21- Financial Management Responsibility; Sponsored Clinical Trials Administration policy; Sponsored Agreements Closeout Policy; Vice Chancellor for Administration and Finance (VCAF) 001 regarding collection of personal identifiers for paid clinical trial participants; Policy and Procedures 2.09 IRB Protocol Review Fee; and Policy and Procedures (P&P) 5.02 Record Keeping by Investigators; and P&P6.01 Informed Consent.

HSCNO signed a Memorandum of Understanding with the LSU Healthcare Network (LSUHN) on April 24, 2020, that gives authorization to LSUHN to seek on behalf of HSCNO and its faculty, non-federal privately funded pharmaceutical and device manufacturer clinical trials, to be contracted by and through the LSUHN as the exclusive agent of HSCNO. The program has not been promoted or utilized by LSUHN within the scope of the audit due to COVID-19; however, HSCNO and LSUHN plan to use this program to help generate increased revenue by expediting trial approval processes and increasing the facilities and administrative fees.

From Fiscal Year 2018 to 2020, there were a total of 354 sponsored clinical trials with financial activity. 213 (60%) trials were sponsored by pharmaceutical corporations and 101 (29%) by corporate/private medical and research entities. The remaining 40 (11%) were sponsored by other entities such as research foundations, other universities, and non-profits. During this period, HSCNO recorded a profit of \$1,282,131 from these 354 trials. See the chart below for financial activity from each fiscal year.

HSCNO Clinical Trial Financial Summary from Fiscal Year 2018 - 2020				
	2018	2019	2020	Total
Revenues	\$ 1,394,111	\$ 3,090,149	\$ 893,099	\$ 5,377,358
Expenses	\$ (1,207,655)	\$ (1,301,132)	\$ (1,586,441)	\$ (4,095,228)
Surplus /Deficit	\$ 186,456	\$ 1,789,017	\$ (693,342)	\$ 1,282,131
Source: Data generated from PeopleSoft reports using private queries provided by management.				

SCOPE AND OBJECTIVES

The primary audit objectives were to determine if the following internal controls are in place and operating effectively:

1. Appropriately and timely approving clinical trials.
2. Required trial documentation and processes are properly completed (patient consent forms, conflict of interest, staff training).
3. Accurately billing for trial services and collecting all trial revenue due.
4. Compensating trial participants in accordance with the CTA.
5. Closing trials in accordance with policy.
6. Access to the clinical trial system is granted appropriately.

The scope of our work included private, non-federal sponsored clinical trials that were active or closed during Fiscal Year 2020. Federally sponsored trials and trials managed at the LSUHNSC were excluded from the scope. Testing methodology is summarized below, by category.

Clinical Trial Administration

- Reviewed clinical trial agreements to ensure: each trial was fully approved by HSCNO administration and the sponsor; a detailed budget grid and confidentiality clause were included in the agreement; and the trial was approved prior to services beginning. See **Finding #1**.
- Reviewed clinical trial agreements to determine if any specialized training was needed for trial personnel. Reviewed HSCNO compliance training policies and guidelines to determine which training was required for employees with responsibilities related to clinical trials. Requested and reviewed training records from HSCNO’s Office of Compliance to ensure trial personnel and HSCNO employees completed all required training related to clinical trials. See **Finding #1**.
- Physically inspected all participants’ records within our trial sample to ensure: a consent form was signed prior to receiving services, the trial was approved before any participant received services, and applicable participants reconsented if trial protocols were amended. Test procedures yielded no issues with participant consents.

Clinical Trial Closeout

- The Louisiana Legislative Auditors Office (LLA) found, during their annual audit, issues with sponsored project closeouts and reconciliations at HSCNO. The control weaknesses found during their audit are the same controls in place for closing and reconciling clinical trials; therefore, we did not perform testing of clinical trial closeouts. See **Finding #1**.

Clinical Trial Billing & Collection

- Compared reports from PeopleSoft, HSCNO’s financial and administrative system, with trial budget grids to confirm administrative and IRB fees were billed and collected, and IRB fees were transferred to the IRB account. See **Finding #2**.
- Verified trial services performed for a sample of participants were billed and collected in accordance with the trial budget grids. See **Finding #2**.

Clinical Trial Participant Compensation

- Reviewed payments made to trial participants to ensure compensation aligned with the CTA and verified participants who received \$600 or more in a single year were provided a Form-1099-MISC. See **Finding #3**.

Clinical Trial System Access:

- Identified users with access to the IRB’s clinical management system, Quali. Determined if each user’s permissions and access were appropriate based on their job responsibilities. No reportable issues were found during testing.

Procedures that yielded issues are discussed in our recommendations to management. This internal audit activity was conducted in conformance with the *International Standards for the Professional Practice of Internal Auditing* set by the *Institute of Internal Auditors*.

FINDINGS AND RECOMMENDATIONS

Finding No. 1: Trial Administration Governance

Existing internal controls do not provide assurance that trial administration is being effectively managed by HSCNO. A lack of effective administrative controls could result in legal and financial ramifications due to non-compliance with state and federal regulations and non-adherence to contract and trial protocol terms. During our review, we noted the following issues:

- **Comprehensive Trial Listing** - HSCNO does not have a comprehensive database that effectively tracks all clinical trials. HSCNO Sponsored Clinical Trials Administration policy requires management to maintain an accurate, comprehensive list of all active university trials. In previous audits, we noted the IRB and Sponsored Projects maintained separate lists of trials without a common identifier. Without an identifier, we cannot compile a comprehensive list of active, on-going trials at HSCNO. For example, one sample trial selected was not an active trial, but an account used to collect revenue received from Children’s Hospital for services provided by HSCNO physicians.
- **Executed Clinical Trial Agreements** - For the trials in our sample, we were unable to obtain fully executed agreements from a central source. Efforts from Sponsored Programs, Office of Research Services, and Medical School business managers were

needed to receive fully executed trial agreements. In 2020, HSCNO implemented a new trial approval system (Kuali) to monitor and document the approval process for clinical trials; however, the trials in our sample were approved prior to the implementation.

- **Timely Trial Approvals** - HSCNO policies and procedures require trial approval in advance of services being provided to trial participants. One trial in our sample was not fully executed prior to the first participant receiving services. The trial participant received their first services 52 days prior to the sponsor signing the agreement.
- **Conflict of Interest Attestations** – According to HSCNO P&P1.04, Conflicts of Interest (COI), COI reviews shall be maintained for at least three years after the date of the final expenditures report, termination, or completion of the research project. HSCNO transitioned conflict of interest systems in 2020 from Osprey to Kuali. According to the IRB, HSCNO no longer has access to the old system; therefore, COI forms prior to 2020 cannot be retrieved. All current trial personnel in our sample completed COI attestations as required since the transition to Kuali.
- **Trial Closeout** - According to the Louisiana Legislative Auditors Office, HSCNO did not have adequate controls over project closeouts or accounting records for sponsored programs. The LLA report identified the following control weaknesses: 1) the accounting system, PeopleSoft Commitment Control, allows certain personnel and other expenses to continue to post to projects after the project has ended unless a form, such as a personnel status change form, is processed to update account coding in the system; 2) projects are not being closed out properly as they end, which includes submitting all required forms for updating accounting records; and 3) project budgets were not adequately monitored to ensure that expenses in the accounting system were charged to the correct project, and any errors or budget overruns were identified and addressed in a timely manner. Furthermore, an LSU internal audit finding in the Fiscal Year 2018 HSCNO clinical trial audit reported issues with trial closeout procedures and lack of account reconciliations. The report stated controls were inadequate to ensure trial accounts were reconciled, residual balances were transferred timely, and accounts were closed at the projects’ end.

Recommendation: We recommend management strengthen controls to ensure:

- A comprehensive listing of clinical trials is maintained by HSCNO.
- Fully executed CTAs are filed in a centralized location.
- CTAs are fully executed prior to participants receiving services.
- COI records are maintained in accordance with compliance training policy.
- Account reconciliations and closeouts occur in accordance with the HSCNO Sponsored Agreement Closeout Policy.

Management’s Response: HSCNO management agreed with the recommendation and will implement corrective action by December 31, 2021. The response can be found in its entirety in Appendix A.

Finding No. 2: Clinical Trial Billing and Collection

Existing internal controls do not provide assurance that all clinical trial fees and revenue are billed and received. HSCNO Sponsored Clinical Trials Administration Policy requires management to monitor billing and collection to ensure contract requirements are met and trial services and fees are billed and collected timely. Of the nine applicable sampled trials, six (67%) could not provide verification that trial services were billed and collected for individual trial participants as defined in the CTA. Lack of proper billing controls can result in funding private research with state dollars and loss of revenue.

Recommendation: We recommend management implement additional controls to ensure all clinical trial services and fees are billed and collected timely in accordance with trial agreements.

Management’s Response: HSCNO management disagreed with the findings of the sample of transactions tested and stated that each of the six identified in the audit were properly invoiced and payments received. No corrective action was provided.

Auditor’s Additional Comments: Although management asserts that each of the six samples were properly invoiced and payments received, we did not receive documentation to substantiate this statement. Additionally, in a preliminary discussion with management on July 30, they agreed with the findings regarding trial billing and collection as well as patient compensation. They again agreed with the findings in the exit meeting on August 25, committing to a response by September 8. After returning from closure related to Hurricane Ida, HSCNO requested an extension to September 20, which was granted. Upon inquiry into the status of management’s response on September 27, HSCNO stated they could provide documentation to clear up some of the issues; an additional extension was granted until October 1. Documentation was ultimately provided on October 8; however, that document did not sufficiently address the issues. The errors that remain outstanding are detailed below.

- Trial 1- Invoiced the sponsor \$1,185 for a visit that should have been invoiced at \$1,630 pursuant to the CTA. In an email from the Business Manager on 7/27/21, he could not provide an explanation for the variance and said he would request detail from the sponsor. Our discrepancy related to “Week 48 OL visit” and the only documentation subsequently provided related to “Week 12 OL visit.”
- Trial 2- Invoiced the sponsor \$760 for both 12- and 18-month visits, which the CTA budget allowed \$2,510 and \$635, respectively. In an email from the Clinical Research Coordinator on 7/9/21, she acknowledged that there were errors with invoices from 2019 and 2020 that did not include all billable items.

- Trial 3- Invoice dated 6/10/19 had not been paid as of the 7/6/21 A/R Aging Report. Upon inquiry into the unpaid invoice, the Contracts Administration Officer stated in an email on 7/15/21 that he would need to investigate. After drafting the report, it appears a check was received from the sponsor and entered 7/31/21. Although payment was ultimately rendered, over two years had elapsed since the invoice at the time of our testing, indicating a potential breakdown in review of outstanding collections.
- Trial 4- The CTA allowed for a \$100 per-subject fee for site impressions, a \$280 per-subject fee for screening/enrollment, and a \$30,000 cost for PI time and effort. We asked for evidence that the \$30,000 PI fee and \$280 fee for a particular subject were both invoiced. Management responded with an invoice that only showed the \$100 for that subject and did not include the PI fee, leaving an unexplained discrepancy of \$30,280.
- Trial 5- According to the Coordinator of Clinical Research in an email on 7/7/21, the total charges for our sampled subject equaled \$24,402 for the period. Only two invoices were provided related to this subject, one for \$4,122 and the other for \$4,063, leaving \$16,217 for which we have not received evidence that the sponsor was billed.
- Trial 6- We were provided a list of patients that were screened for the study but did not meet recruitment criteria. The CTA allows a pre-screening fee to be reimbursed by the sponsor for pre-screened subjects who do not sign Informed Consent; however, six individuals were listed as being involved in pre-screening but did not qualify for the trial. Management's argument is that the patients weren't questioned or seen by the Coordinator, so there was not enough "reasonable effort" to get them enrolled. While this may be the case, we were provided no documentation to support this conclusion (e.g. clinical visit notes) other than their testimony.

Finding No. 3: Participant Compensation

Controls may be ineffective in ensuring trial participants receive compensation in accordance with the CTA. The CTA outlines the amount to be paid to each participant, method of payment, payment frequency, and criteria for compensation eligibility. In addition, HSCNO policy VCAF-001, Collection of Personal Identifiers for Paid Clinical Trial Participants, requires a Form-1099-MISC to be issued to any participant that earns \$600 or more in a calendar year for clinical trial participation. Control weaknesses could result in loss of trial revenue or failure to pay participants in accordance with contract terms. Our review disclosed two of seven (29%) trial participants did not receive the correct compensation amount based on the CTA. One patient received duplicate payments in error for a single visit while another participant failed to receive payment for a visit.

Recommendation: We recommend management enhance controls to ensure clinical trial participants receive compensation as outlined in the CTA. We also recommend incorrect payment amounts to participants be corrected, when possible, to ensure compliance with the CTA.

Management’s Response: HSCNO management provided corrective action but noted that there was only one incorrect payment to a participant which occurred in 2016. The response can be found in its entirety in Appendix A.

Auditor’s Additional Comments: A second error was noted and communicated to area management regarding a subject who did not receive payment for an unscheduled visit in December 2019. In an email from the Clinical Research Coordinator on 5/26/21, she stated that the auditor was “absolutely correct” that the participant was missing a payment. In a subsequent email on 6/8/21, she specified that after reviewing clinic notes and protocol with the monitor, it was confirmed to be considered an unscheduled visit, the payment had been requested in ClinCard, and reimbursement would be billed to the sponsor.

However, in a later email to the Office of Compliance Programs she states that the visit did not meet the criteria for an unscheduled visit according to the protocol because no MRI was completed nor was a study questionnaire. Once again, we were not provided any visit-related documentation that would substantiate their conclusion.

DISTRIBUTION LIST

William Tate IV, President

Matthew Lee, Interim Executive Vice President and Provost

Donna Torres, Interim Executive Vice President for Finance & Administration/CFO

Winston DeCuir Jr., Vice President and General Counsel

Larry Hollier, Chancellor

Keith Schroth, Vice Chancellor for Administration & Finance

Demetrius Porche, Interim Vice Chancellor for Academic Affairs

Steve Nelson, Dean, School of Medicine

APPENDIX A –
MANAGEMENT'S RESPONSE



OFFICE OF THE CHANCELLOR

SCHOOL OF ALLIED HEALTH PROFESSIONS
SCHOOL OF DENTISTRY
SCHOOL OF GRADUATE STUDIES
SCHOOL OF NURSING
SCHOOL OF MEDICINE IN NEW ORLEANS
SCHOOL OF PUBLIC HEALTH

October 8, 2021

Chad Brackin, CPA, CFE
Chief Auditor
Office of Internal Audit
Louisiana State University
3810 W. Lakeshore Dr. Rm. 122
Baton Rouge, LA. 70808

Dear Mr. Brackin,

We have reviewed the draft report regarding the Clinical Trials audit conducted by your office. We appreciate the time and effort that your staff took working with us. Please find our responses to the findings below.

Management agrees with the recommendations listed in the report.

Finding #1: Trial Administration Governance

Recommendation(s): We recommend management strengthen controls to ensure:

- A comprehensive listing of clinical trials is maintained by HSCNO.
- Fully executed CTAs are filed in a centralized location.
- CTAs are fully executed prior to participants receiving services.
- COI records are maintained in accordance with compliance training policy.
- Account reconciliations and closeouts occur in accordance with the HSCNO Sponsored Agreement Closeout Policy.

Corrective Action(s):

LSUHSC-NO has approved the creation of a centralized Clinical Trials Office (CTO) under the umbrella of the Office of Research Services (ORS). The CTO will be responsible for organization and management of the pre-award component (and some post-award activities) of sponsored clinical trials. This centralized office will be able to address most of the pre-award deficiencies identified in the audit.

A comprehensive list of clinical trials is already maintained by ORS in the Kualai Research system. ORS will provide Sponsored Projects Accounting (SPA) with a unique identifier from the Kualai system that will be used in People Soft. New clinical trials are being entered with the common unique identifier. Existing clinical trials will be worked on as time and resources permit. Consequently, in the future, a list of clinical trials including their financial and regulatory status can be generated on demand using the common identifier.

The Office of Grants & Contracts (OGC) in the ORS is responsible for reviewing and obtaining VCAA approval of all research contracts and agreements. Effective, this past summer, submission and review of the agreements is now handled through the Negotiation module of the Kualai electronic platform. This module serves as a repository for all versions of a given agreement. OGC will copy ORS at the project set-up, which includes a fully executed copy of the CTA. ORS will upload all fully-executed contracts into Kualai before final approval of the research project.

For the past two years, ORS has continued to request legacy COI disclosure data from the previous vendor, Osprey. We would like to point out that ORS does have records of COI disclosures for 2020 and 2021 in the Kualai system. We also have a copy of the last COI disclosure report that was generated from Osprey's COI Risk Manager system which covers the year 2019. So, collectively, we have disclosure records for the three-year period from 2019 to 2021. However, we will continue to work with Osprey to obtain past COI disclosure data.

SPA currently sends a list of open clinical trials to Business Managers periodically throughout the year. These emails request review of the open clinical trials. If any need adjustments or close outs are required, that information will be SPA, including the close out packet as applicable. Departments are responsible for account reconciliations and ensuring projects are closed out in accordance with policy.

On June 30, 2021, a reminder of CM-21 requirements, along with a School of Medicine CM-21 Implementation Policy was sent to all SOM Business Managers. The School of Medicine will also require departments to include the name of the fiscal agent (if not the business manager) to be identified on the CM-21 reports. ORS will update the training materials for clinical trials. ORS is working with the Compliance Office and Information Technology to provide training as part of the requirements for the Knowledge Delivery System (KDS) for those individuals that have responsibility in clinical trials.

Additionally, LSUHSC New Orleans leadership is exploring clinical trial management systems with our partner hospitals, which would further enhance tracking and monitoring of clinical activities.

Anticipated Completion Date: December 31, 2021

Responsible Personnel: Executive Director of the Office of Research Services

Finding #2: Clinical Trial Billing and Collection

Recommendations: We recommend management implement additional controls to ensure all clinical trials services and fees are billed and collected timely in accordance with trial agreements.

Corrective Actions:

Management disagrees with the findings of the sample of transactions tested. Each of the six identified in the audit were properly invoiced and payments received.

Anticipated Completion Date: N/A

Responsible Personnel: N/A

Finding #3: Participant Compensation

Recommendation: We recommend management enhance controls to ensure clinical trial participants receive compensation as outlined in the CTA. We also recommend incorrect payment amounts to participants be corrected, when possible, to ensure compliance with the CTA.

Corrective Actions:

Management would like to note that there was only one incorrect payment to a participant which occurred in 2016. During reconciliations required by CM-21, should any incorrect payments to participants be identified, corrections will be made as needed. Management has requested the Office of Compliance Programs to include clinical trials in the annual risk assessment and conduct monitoring and auditing based on this assessment, which is consistent with the recommendations made by the LSU System office audit report dated April 30th 2019. When a monitoring audit is conducted it will be a random review of a sample of clinical trials to ensure sponsors are billed and revenues are collected in accordance with the CTAs.

Anticipated Completion Date: December 31, 2021

Responsible Personnel: Director of Compliance Programs

If you have any additional questions or concerns, please do not hesitate contacting me.

Respectfully,

A handwritten signature in blue ink that reads "Larry Hollier, M.D." in a cursive style.

Larry Hollier, MD
Chancellor

pc: Mr. Keith Schroth, Vice Chancellor of Administration and Finance
Dr. Demetrius Porche, Interim Vice Chancellor of Academic Affairs
Dr. Steve Nelson, Dean, School of Medicine
Ms. Arlean Wehle, Executive Director, Accounting Services
Dr. Jawed Alam, Executive Director, Office of Research Services
Ms. Lori Ferro, Director, Office of Compliance Programs

Memorandum

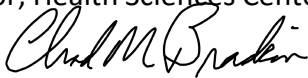
To: David Lewis, Acting Chancellor, Health Sciences Center Shreveport
 From: Chad Brackin, Chief Auditor 
 Subject: LSU Health Sciences Center Shreveport Clinical Trials

Executive Summary:

In December 2020, the LSU Office of Internal Audit initiated an audit of clinical trials at the Health Sciences Center in Shreveport (HSC-S) from the Board-approved Audit Plan. The objective was to provide an evaluation of the controls in place to mitigate risks related to the areas of trial administration, billing, and finance. Our planning process included conducting interviews with key stakeholders, reviewing policies and procedures, and performing walk-throughs to get an understanding of the internal control environment. We requested data beginning January 6, 2021, but the documentation was not sent timely and was insufficient to complete testing.

Background:

The Health Sciences Center Shreveport has over 32 years of experience conducting clinical trials in the pharmaceutical and biotechnology field across 32 medical specialties and offers clinical trial capabilities in over 100 therapeutic areas in phase I-IV clinical and gene therapy trials. A centralized clinical trials office is responsible for negotiating clinical trial agreements and managing clinical trials. While all clinical trials are managed within this office, they work collaboratively with the Institutional Research Board (IRB), Human Research Protections Program, the Office of Sponsored Programs, and the Medical School Accounting Office to ensure trials are managed appropriately, comply with federal and state regulations, and meet all contractual obligations as specified in the agreement.

Findings:

During fieldwork, we encountered the following issues which limited the scope of our audit and our ability to perform assurance testing related to HSC-S clinical trials controls:

- **Potential Unresolved Issues from Prior Audit in Fiscal Year 2014** – Internal Audit released an audit report of HSC-S clinical trials on January 29, 2015, with six findings. While some of the past issues may be resolved, namely lack of policies and procedures regarding several processes in clinical trials, the overlying issue of control weaknesses and failure to mitigate these weaknesses appear to have remained. For example, the previous audit noted that HSC-S was unaware if the institution was recovering costs related to trials, controls were inadequate to ensure the institution was reimbursed for services provided to trial

participants, trials remained financially active in PeopleSoft despite being closed by the IRB, and financial accounts were not being created for active trials. During our planning interviews and initial fieldwork, each of these issues still appear unresolved. See Appendix B for the previous audit report, findings, and action plans.

- **Lack of Comprehensive and Cohesive Trial Lists** – In January 2021, Internal Audit requested a comprehensive list of active clinical trials from the Institutional Review Board (IRB) and Grants Accounting to include the following information: trial number, trial name, Principal Investigator (PI) name, PeopleSoft account number, financial information for each trial, start/end dates, and a value distinguishing if a trial was publicly or privately funded. While we received both lists, there was a significant difference in the number of trials between each list and there was no common denominator to link the trials between the lists. The PeopleSoft list provided by Grants Accounting had 243 trials while the list provided by the IRB had 120. The clarification provided by the Office of Research and Grants Accounting was not sufficient to determine the reason for differences between the two lists.
- **Insufficient Trial Data** – While attempting to choose a sample of trials to test, Internal Audit could not determine if the trials listed as active had recent financial activity. Many of the trials in the lists provided appeared to be several years old, and PeopleSoft indicated no evidence of ongoing financial activity. Notes made by HSC-S staff in their reconciliation of trials demonstrated several issues such as the following: no known PI listed; trials closed by the IRB that had not been closed financially; and trials listed by the IRB that could not be located in PeopleSoft. Additionally, during planning interviews it was stated that, due to vacancies in the clinical trial office, trial financials may not have been invoiced, monitored, or reconciled, especially for older trials.
- **Timeliness of Data Requests** – Internal Audit experienced substantial delays in receiving data and documentation. The IRB and Grants Accounting provided trial lists from our initial requests timely. However, due to discrepancies between the lists, we asked for clarification on January 25th. After receiving no response, we subsequently sent seven follow-up emails between February 2nd and March 15th. Internal Audit received a response on March 24th.

After pulling a sample of active and closed trials, Internal Audit sent an initial request on April 7th for sample documentation to begin testing. We sent two follow-up emails on April 19th and 23rd. The Office of Research called on April 30th stating that they assembled a team to pull the documentation and would provide a weekly data dump starting on May 7th and ending May 28th. As of May 28th, we received the initial data requested; however, this was only the initial submission of documentation. Additional requests for more specific and complex documentation would be necessary to complete testing. Based on the timeliness of documentation received thus far, these requests may take several months to fulfill.

We met with HSC-S management on July 2, 2021, to confirm the issues noted above. Management agreed with our assessment and stated that the current clinical trials management system is unable to manage all aspects of clinical trials; therefore HSC-S is currently in the process of implementing Oncore, a new clinical trial management system to alleviate many of their current issues.

Due to the issues noted above, Internal Audit is suspending further work on this audit until the new clinical trial management system and controls have been implemented and strengthened to correct these weaknesses. We will provide advisory services as needed during the course of the implementation with a report to be issued subsequently. We ask that you provide a plan of action to address the above noted issues along with a timeline and expected date of completion.

DISTRIBUTION LIST

William Tate IV, President

Matt Lee, Interim Executive Vice President & Provost

Donna Torres, Interim Vice President for Finance and Administration/CFO

Winston DeCuir Jr., Vice President of Legal Affairs and General Counsel

David Lewis, Acting Chancellor, Health Sciences Center Shreveport

Christopher Kevil, Vice Chancellor for Research, Health Sciences Center Shreveport

Cindy Rives, Vice Chancellor for Administration and Finance, Health Sciences Center Shreveport

APPENDIX A –
MANAGEMENT'S RESPONSE

Health Sciences Center

Vice Chancellor of
Administration and Finance

1501 Kings Highway
P.O. Box 33932
Shreveport, LA 71130-3932

O 318-675-5291
www.lsuhseshreveport.edu

July 27, 2021

Chad M. Brackin, CPA, CFE
Chief Auditor

Kevin R. Starns, CPA, CIA
Internal Audit Manager

Louisiana State University System
3810 West Lakeshore Drive, Suite 122
Baton Rouge, Louisiana 70808

RE: Memorandum to LSU Health Sciences Center Shreveport Clinical Trials

Detailed below are LSU Health Shreveport (LSUHS) Management's Response to the Draft LSUHSCS 2113 Clinical Trials Audit Memorandum Findings received on July 12, 2021. This Audit was a follow-up to 1416 Clinical Trials Management Issued January 29, 2015.

Finding: Potential Unresolved Issues form Prior Audit in Fiscal Year 2014

Response: LSU Health Shreveport (LSUHS) agrees that administrative and financial monitoring of clinical trials should be further enhanced through tracking of trial activity, costs, and closure. Please refer to the Management Summary section for plan.

Responsible Personnel: Clinical Trials Services, Accounting Services, Compliance Policy Committee, and Department

Implementation Date for Follow-Up: *June 30, 2022*

Finding: Lack of Comprehensive and Cohesive Trial Lists

Response: LSU Health Shreveport (LSUHS) agrees that current clinical trials administrative and financial systems should continue to be reviewed and monitored to ensure the trials can be identified in both non-integrated systems. Please refer to the Management Summary section for plan.

Responsible Personnel: Research Data Management Team, IRB Director, Clinical Trials Services, and Accounting Services

Implementation Date for Follow-Up: *June 30, 2022* for review of current systems

Finding: Insufficient Trial Data

Response: LSU Health Shreveport (LSUHS) agrees that the clinical trial data maintained within the two non-integrated systems, SHleLDS and Peoplesoft Financials should be reviewed regularly for completeness. Please refer to the Management Summary section for plan.

Responsible Personnel: Clinical Trials Services and Accounting Services

Implementation Date for Follow-Up: *June 30, 2022*

Finding: Timeliness of Data Requests

Response: LSU Health Shreveport (LSUHS) acknowledges there were delays in providing data. The institution will respond to future requests with either the status of the request submission and/or actual data.

Responsible Personnel: Clinical Trials Office and Accounting Services

Implementation Date for Follow-Up: *Immediate*

Management Summary Section

Since the initial Internal Audit (HSC-S 1416 Clinical Trials Management) Report issued on January 29, 2015, there have been several personnel changes and significant turnover in the Clinical Trials Services (CTS) offices impacting the training of employees and continuity of processes. With approval, the following employee functions were hired to ensure the continuity of clinical trial services and adequate management oversight and review of administrative and financial functions/data.

Business Manager (Financials) in CTS hired December 2020

Project Manager (Contract Agreements/Budgets) in CTS hired January 2021

Project Coordinator (Invoicing) in CTS hired April 2021

Assistant Director in Accounting Services hired June 2021

Medical Director of CTS -- in process

Administrative Director of CTS – in process

The newly hired Assistant Director in Accounting Services will be dedicated to working with CTS on clinical trial financial oversight. Clinical Trial Services (CTS) and Accounting Services (AS) are currently performing a review of all standard operation procedures (SOPs) related to clinical trials in preparation for submission of its Step 1 Application for AAHRPP re-accreditation at the end of the current fiscal year.

LSU-701: Contract/Budget Policy for Research Studies

LSU-702: Policy for Generation

LSU-703: Policy for Clinical Trial Closeout

LSU-704: Policy for Cost Transfer Procedures and Approvals for Sponsored Projects

LSU-705: Policy for Account Establishment Upon IRB Approval

LSU-706: Policy for Costs for Sponsored Programs

CTS and AS are also in the process of creating new SOPs to align more closely with their respective operations in areas such as study creation, naming conventions, trial activity and cost transfers, closeout, and establishment of a control group to create and maintain a comprehensive and cohesive list of trials. CTS and AS will periodically review established policies and procedures to identify further areas for improvement and to incorporate relevant best practices. This will be accomplished through, initially, weekly meetings, between the all of the staff reflected above. The results of the meetings will be discussed and reviewed at the CTS monthly committee meetings.

Additionally, LSU Health Shreveport (LSUHS) has begun negotiations with Advarra to implement a more comprehensive clinical trial management system (OnCore). Advarra will provide professional services to implement OnCore and its related software. This implementation, from date of contract execution, is estimated to take 15 months to complete (End of 3rd Q FY2023).

However, until OnCore is fully implemented, CTS and AS will work to ensure proper system trial data pre-implementation plan and protocols are followed and accomplished through efforts outlined above. This will include coordinating efforts with our hospital partner that manages the patient electronic health record system, EPIC.

Please advise if additional information is required at this time.

Sincerely,

A handwritten signature in blue ink that reads "Cindy Rives". The signature is written in a cursive style.

Cindy Rives, MPA
Vice Chancellor for Administration and Finance

Cc: David F. Lewis, MD, MBA
Interim Chancellor & Dean

APPENDIX B –
HSC-S 1416 CLINICAL TRIALS MANAGEMENT

Louisiana State University System
Office of Internal Audit
FINAL - CONFIDENTIAL



**CLINICAL TRIALS
MANAGEMENT**

January 29, 2015

*LSU Health Sciences Center
Shreveport*

1860

SYSTEM

**LOUISIANA STATE UNIVERSITY SYSTEM
BOARD OF SUPERVISORS – AUDIT COMMITTEE**

Mr. Stanley Jacobs, Chair
Mr. Scott Angelle, Vice Chair
Mr. Ronald R. Anderson
Mr. Hank Danos
Mr. Jack Lawton
Mr. Lee Mallett
Mr. James W. Moore, Jr.
Mr. Robert “Bobby” Yarborough
Mr. Thomas Skinner, Ex Officio

PRESIDENT AND CHANCELLOR

Dr. F. King Alexander

LSU SYSTEM INTERNAL AUDIT

CHIEF AUDITOR

Chad M. Brackin, CPA, CFE

ASSOCIATE CHIEF AUDITOR

Sonya G. McCoy, CPA

DIRECTOR

James Ponce, CPA, CFE, CIA

INTERNAL AUDITORS

Tryone Johnson, CHC
Kyle Brady

Table of Contents

EXECUTIVE SUMMARY	1
SCOPE AND OBJECTIVES	2
BACKGROUND	3
FINDINGS AND RECOMMENDATIONS	4
Finding No. 1: No executed master research agreement between LSU HSC-S and the Biomedical Research Foundation	4
Finding No. 2: Financial monitoring of clinical trials is not adequate	4
Finding No. 3: Lack of financial closeout and residual balance policy and procedures	4
Finding No. 4: Untimely cost transfers	6
Finding No. 5: General ledger accounts not established for clinical trials	7
Finding No. 6: Lack of a written cost policy and procedures	8
DISTRIBUTION LIST	9
APPENDIX A: MANAGEMENT’S RESPONSE	10

EXECUTIVE SUMMARY

Internal Audit completed an audit of human research clinical trials at the LSU Health Sciences Center – Shreveport (HSC-S) from the Board-approved Fiscal Year 2014 Audit Plan. This audit report provides an evaluation of the controls for the processes used to manage clinical trials. Clinical trials are interventional research studies that explore whether a medical strategy, treatment, drug, or medical device is safe and effective. HSC-S created the Human Research Protection Program (HRPP) to safeguard and promote the health and welfare of human research subjects by ensuring that their rights, safety, and well-being were protected. HSC-S received its initial accreditation from the Association for the Accreditation of Human Research Protection Program (AAHRPP) in 2009 and was re-accredited in 2012.

The HSC-S processes reviewed included the initiation, approval, monitoring and closing of clinical trials. The accounting processes reviewed included the accuracy of recording the revenues and expenses and invoicing the Institutional Review Board (IRB) fees. The processes reviewed for compliance included medical reviews and reporting noncompliance with protocols.

Due to the practices currently in place, the institution is at risk of not fully covering the cost of private research, thereby funding private research with state dollars. Processes requiring attention from management include:

- Finalizing the master research agreement with the Biomedical Research Foundation
- Conducting final reviews of trial balances and payments for medical services
- Ensuring accurate, complete, and timely recording of revenues and expenses

We recommend the following changes to strengthen the clinical trial processes:

1. Establish a master research agreement with the Biomedical Research Foundation
2. Establish financial reports to ensure HSC-S is recovering costs related to clinical trials
3. Develop a written financial closeout and residual balance policy and procedures for sponsored projects
4. Develop written cost transfer procedures and approvals for sponsored projects
5. Establish clinical trial general ledger accounts immediately upon IRB trial approval
6. Develop a written cost policy and procedure for sponsored projects

The policies recommended above are consistent with policies that have been developed at research universities such as LSU HSC-New Orleans, Tulane University, the University of Colorado at Denver and Florida State University.

Management agreed with these recommendations and is in the process of implementing action plans. We appreciated the assistance provided by the LSU Health Sciences Center – Shreveport personnel during the engagement.

SCOPE AND OBJECTIVES

The scope of the audit included reviewing non-federal clinical trial processes at LSU Health Sciences Center – Shreveport (HSC-S) for fiscal years 2011 through 2014. The scope included reviewing clinical trial records including clinical trial agreements, protocols, and schedule of events; accounting records including trial budgets, invoices, inter-agency transfers, deposit transfers, payments, and receipts; research records; participant records including medical bills to payers, and remittance advices; IRB minutes and monitoring reports; and Information Technology access and exceptions reports.

The objectives of the audit were to evaluate the effectiveness of the:

- Internal controls to mitigate financial risk
- Approval of clinical trials
- Monitoring compliance of clinical trials
- Access controls to information technology for protecting clinical trial and participant data stored electronically

Six clinical trials were used as our sample items to perform a majority of the audit tests. The sponsors for those six trials were HemaQuest Pharmaceuticals (HemaQuest), Clavis Pharma (Clavis), Otsuka Pharmaceutical Development & Commercialization (Otsuka), Avid Radiopharmaceuticals (Avid), Solvay Pharmaceuticals (Solvay), and Nestle' Nutrition USA (Nestle). There were 29 participants among the six clinical trials.

The following procedures were performed without issue:

- Reporting noncompliance – 45 CFR 46.103 requires notifying federal authorities about instances of unanticipated problems, serious or continuing noncompliance with the trial, or termination of IRB approval. Sixty-one correspondences from the IRB to the federal Office of Human Research Protection and the Food & Drug Administration were reviewed to determine if they were within federal guidelines for reporting instances of noncompliance. HRPP and IRB management have adequately managed the risks of reporting instances of noncompliance to federal authorities.
- Financial Conflicts of Interest – 42 CFR 50.603 requires researchers to disclose financial conflicts of interest (e.g. compensation, equity ownership, etc.) involving the research they are conducting. Evaluation has been completed of the policies and procedures that HSC-S requires for disclosing and training on conflicts of interest. The Office of Legal Affairs has adequately managed disclosures of financial conflicts of interest.
- Completeness of trial revenues – The payments for 13 trials were confirmed by the sponsor and accurately recorded in the general ledger.
- Approval of the clinical trials – For the sample selected, review of supporting documentation indicated appropriate IRB approval prior to the start of the trials.

- Approval of modifications – A sample of 12 modifications from the Solvay, Avid Radiopharmaceutical, and Nestle clinical trials were reviewed to determine if the IRB had reviewed and approved them in accordance with HRPP Standard Operating Procedures. The IRB had reviewed and approved the modifications.
- Completion of Consent forms – The consent forms for the 29 participants of the six clinical trials were reviewed for compliance with federal regulation 45 CFR 46.116. The consent forms were complete and signed by the participants. The principal investigators have adequately managed completion of the consent forms.
- Access Controls – The process was reviewed for granting individuals access to the Shields software program, which is used to electronically store clinical trial data. The user-roles that could be assigned to individuals were reviewed and the method for assigning those roles to individuals was evaluated. There were no reportable findings regarding access controls

Procedures that yielded issues are discussed in our recommendations to management. This internal audit activity was conducted in conformance with the International Standards for the Professional Practice of Internal Auditing set by the Institute of Internal Auditors.

BACKGROUND

HSC-S created a Human Research Protection Program (HRPP) in 2008 for the protection of human subjects in clinical trials conducted by researchers under its federal wide assurance (FWA). Through the FWA program, HSC-S commits to the department of Health and Human Services (HHS) that it will comply with the requirements in the HHS Protection of Human Subjects regulations at 45 CFR part 46. HSC-S received its initial accreditation from the Association for the Accreditation of Human Research Protection Program (AAHRPP) in 2009 and was re-accredited in 2012. Reaccreditation will be required by June 2017.

The HRPP Department has 14 full-time employees, two temporary employees (one part-time and one full-time as needed) and an employee from the Office of Legal Affairs. HRPP has a medical director who receives supplemental pay for his role as liaison between the faculty and the IRB. Employee responsibilities include reviewing the adequacy of the protocols, budgets, and agreements prior to IRB review, reviewing modifications, and conducting continuing reviews. A Quality Assurance group audits and monitors trials for compliance with IRB protocols, federal and state regulations, and issues of unanticipated problems, noncompliance, suspensions and terminations. Employees also educate the researchers about protocol completion and verify that the researchers have completed their required Collaborative Institutional Training Initiative (CITI) courses.

Clinical trials are interventional research studies that explore whether a medical strategy,

treatment, drug, or medical device is safe and effective for humans. The participants receive the interventions based upon a research plan or protocol created by a principal investigator, who is often a medical doctor. Clinical trials must follow strict scientific standards that are designed to protect participants from harm. Participants are provided an informed consent to understand the benefits as well as the risks involved in participating in a clinical trial.

The Institutional Review Board (IRB) is responsible for ensuring that trials are ethical and the risks of the trial are minimal to the participants. The IRB is also responsible for reviewing, approving, and monitoring studies involving a drug, biologic product, or medical device regulated by the Food & Drug Administration (FDA).

FINDINGS AND RECOMMENDATIONS

Finding No. 1: No executed master research agreement between HSC-S and the Biomedical Research Foundation

The master research agreement between HSC-S and the Biomedical Research Foundation (BRF) has not been finalized and executed. On October 1, 2013, the BRF commenced managing the hospital that was formerly part of HSC-S (medical university).

Patients treated at the hospital are a source of participants for the clinical trials conducted by the staff of the medical university. Since the BRF and HSC-S are two separate legal entities and have two separate management personnel, it is best business practice to have a written agreement between the two entities to specify the terms of the master research agreement.

The scope of the master research agreement is to enable the medical university to engage the BRF in obtaining services and utilizing facilities for research projects. HSC-S management has indicated that the master research agreement has not been completed because BRF management is reviewing the draft agreement.

Recommendation: We recommend that executive management establish a master research agreement with the Biomedical Research Foundation.

Finding No. 2: Financial monitoring of clinical trials is not adequate

Under the current financial process, HSC-S does not know whether the institution is recovering its cost related to clinical trials. Clarity in financial reporting is necessary to ensure the institution is managing state resources appropriately. We requested monitoring reports listing each clinical trial and current balance. The Feist-Weiller Cancer Center was able to provide a suitable report, however the bulk of trials performed at HSC-S were not included. HRPP was not able to provide a financial summary status of the trials.

Recommendation: We recommend that HSC-S establish a reporting mechanism through PeopleSoft or a clinical trial management system to provide management with quarterly reports of trial financial balances. Reporting should be used to ensure HSC-S is recovering its cost to conduct the clinical trials or is adequately identifying and approving self-funded research.

Finding No. 3: Lack of a written financial closeout policy and procedures

HSC-S does not have a written financial closeout policy and procedures for sponsored projects. The audit results revealed that the internal controls were inadequate to ensure that HSC-S had been paid for medical services provided to research participants. In addition, there were inadequate procedures to ensure that trials closed by the IRB had been closed financially.

Medical Chart Reviews – Medical chart review procedures were inadequate to ensure that HSC-S was paid for medical services provided to the research participants. Test results showed that medical services were provided to participants of the HemaQuest, Clavis, and Otsuka clinical trials. However, Feist-Weiller Cancer Center (FWCC) management had not transferred \$2,513 to HSC-S for some of those services. In addition, an anti-seizure drug administered to one participant of the Otsuka clinical trial was not billed to Medicaid as part of standard of care. Without adequate controls, HSC-S is at risk of not receiving payment for medical services provided to the participants and not receiving payment for standard of care charges billed in accordance with federal regulations and national coverage decisions.

Unclosed Accounts – The PeopleSoft general ledger accounts for the HemaQuest, Clavis, Otsuka, and Nestle trials had not been closed. The IRB had approved the requests by the respective principal investigators to close all four of the trials.

Illustrated below is the length of days from the close trial date until our review of the general ledger accounts.

Trial Sponsor	Residual Balance	Date of IRB Closure	Days since close to 4/30/14
HemaQuest	17,885	6/21/2012	485
Clavis	14,989	5/22/2013	246
Otsuka	26,482	7/31/2013	196
Nestle	49,472	3/18/2014	32
Total	108,828		

The trials had not been closed to ensure (1) all services and deliverables contained in the contract had been completed (2) all revenues under the terms and conditions of the contract had been

billed and collected, (3) all expenses of the contract had been paid and recorded in the general ledger and (4) termination of the account in the general ledger with adding a finite financial closure date to prevent any further recording of revenues or transfer of expenses from the account. As a result of the trials not being closed, they had residual balances totaling \$108,828.

Without financially closing the accounts, HSC-S risks expenditure of trial funds without compliance with state laws and university policies. The above errors occurred because of a lack of post-trial review. In addition, the Compliance Department position for the nurse auditor who performed the post-trial reviews for medical necessity and payment accuracy is vacant.

Recommendation: We recommend that executive management develop a written financial closeout policy and procedures for sponsored projects that accomplishes the four objectives above. We also recommend that executive management develop a written residual fund policy and procedures that ensures (1) the university has collected its indirect costs for the trial and (2) transfer of the residual funds to the respective department’s account by the end of the fiscal year in which the trial financially closes for use in accordance with state laws and university policies. These policies should be in-line with requirements at similar research institutions.

Finding No. 4: Untimely cost transfers

Untimely cost transfers were made by HRPP from the Human Subject Research Support (HSRS) account to the clinical trials. There were 61 transfers totaling \$342,389 from the HSRS general ledger account to aged clinical trial accounts, a few of which had been closed by the IRB. Current transfers were made from clinical trials dated as far back as fiscal years 2003 and 2004.

Illustrated below is the total dollar amount of the transfers made in fiscal years 2013 and 2014.

Fiscal Year	No.	Amount Transferred
2013	54	\$ 316,808
2014	7	\$ 25,581
Total	61	\$ 342,389

Thirty-eight of the 61 contained documents to transfer \$201,792 in costs to those clinical trials. The cost transfers of \$201,792 included administrative expenses, such as postage and delivery and the salaries associated with these administrative expenses, such as processing pay vouchers.

These \$201,792 in administrative expenses are considered indirect costs. OMB Circular A-21 section F(6)(b) states: the salaries of administrative and clerical staff should normally be treated as indirect costs. OMB Circular A-21 section F(6)(B)(3) states that items such as office supplies, postage, local telephone costs, and memberships shall normally be treated as Facilities & Administrative (F&A) costs. Section B.4 of the Circular further states “F&A costs are synonymous with ‘indirect’ costs (IDC).”

In addition to charging these indirect costs, the university's IDC rate was applied to some of these trials. As a result, some of these trials were charged an IDC amount and the amount of administrative expense, which is an inconsistent charging practice according to OMB Circular A-21.

A cost transfer involves moving an expense from one account to another. Transfers must be completed in a timely manner and require detailed documentation as to the reason for the transfer. Timeliness and completeness of the explanations of the transfers are important factors in supporting the allowance and allocation of the costs in accordance with the principles of OMB Circular A-21. HSC-S risks noncompliance with OMB Circular A-21 with the inaccurate classification and untimely transfer of indirect costs.

Section 2.1 of the Cost Accounting Standards Board Disclosure Statement (DS-2) states that HSC-S follows the guidelines in OMB Circular A-21 Section F.6.b. HSC-S management acknowledged that the cost transfers lacked timeliness.

Recommendation: We recommend that accounting management develop procedures to ensure that cost transfers are completed in the appropriate fiscal year. In addition, a formal approval process needs to be established to ensure there is adequate oversight of the cost transfers.

Finding No. 5: General ledger accounts not established for clinical trials

PeopleSoft® (PS) general ledger accounts were not established according to the HSC-S Guidelines for Clinical Research (dated 5/11/01). The Guidelines require that when the first payment arrives from the company, the IRB fee will be collected and an account will be established for the project. Without establishing a general ledger account to recording the payments and expenses for each trial, HSC-S risks inaccurately reporting its revenues, expenses and fund balances in the university's financial statements.

There was no general ledger account for four of the trials tested - Pharmaceutical Research Associates (PRA), Pfizer, Mauna Kea Technologies (MKT), and the LSU ICON project. Documents show that:

- IRB fees had been received for all four trials
- The Pfizer and PRA trials had received \$3,200 and \$3,000 in payments, respectively
- The MKT trial had enrolled 17 participants

An interagency agency transfer of \$3,000 had been made from the Neurosurgery Department to the Neurology department for the PRA trial as a reimbursement of expenses. The \$3,200 for the Pfizer trials was a sponsor payment and had been deposited to a clearing account.

The MKT trial had 17 participants and was incurring effort, but no payment had been received on the trial. Invoices had not been completed since the contract was signed in July 2013 to receive payment for the LSU ICON project. As a result, HSC-S risks using state general funds to cover the costs related to these projects.

Recommendation: We recommend Grants Accounting management establish general ledger accounts for the clinical trials immediately following IRB approval. Trial related revenues and expenses should be recorded directly to the trial account in a timely manner to ensure accurate balances are available for the monitoring report in recommendation No. 2.

Finding No. 6: Lack of a written cost policy and procedures

There is a lack of a written cost policy and procedures. The audit results showed that direct costs were not consistently recorded to the trials. The time and effort forms for some of the researchers showed that effort was expended on privately sponsored clinical trials. However, the direct costs, such as salaries and fringe benefits, were not allocated to the trials.

In addition, the study coordinators' salaries and fringe benefits were inconsistently recorded to the clinical trials. The study coordinators' salaries and benefit were recorded for three of the trials (H11-037, H12-107, and H13-054). However, the study coordinators' salaries and benefits were not recorded for the remaining three trials (H10-094, H11-005, and H11-095).

The Cost Accounting Standards Board Disclosure Statement for HSC-S (DS-2) states in section 2.1 that costs that can be identified specifically with a particular sponsored project, instructional activity, or other institutional activity, or can be directly assigned to such activities relatively easily with a high degree of accuracy are treated as direct costs. It further states that every effort is made to classify costs incurred for the same purpose, in like circumstances, consistently as either direct or indirect costs.

The internal controls are not adequate to assure that all direct costs are recorded to the sponsored projects. As a result, the financial performances of these trials are not accurately recorded in the PeopleSoft Accounting System.

Recommendation: We recommend that executive management develop:

- A) Written cost policies and procedures that are consistent with OMB Circulars A-21 and DS-2. Until this is done, HSC-S risks a technical violation in a federal audit without accurately and completely recording the direct costs to sponsored projects. These policies should be in-line with requirements at similar research institutions.
- B) Controls to ensure budgeted net gains or losses for clinical trials are formally approved by the PI before conducting the trial. Budgets should include all expected revenues and expenses, including PI percent effort. By not currently including PI salary costs, the

institution is at risk of not fully covering the cost of private research, thereby funding private research with state dollars.

DISTRIBUTION LIST

F. King Alexander, President and Chancellor, Louisiana State University
Robert Barish, Chancellor, LSU Health Sciences Center - Shreveport
Hugh Mighty, Vice Chancellor for Clinical Affairs
Sheila Faour, Chief Financial Officer
John Marymont, Interim Dean of the School of Medicine
Tom Skinner, General Counsel
Susan Armstrong, Senior Staff Attorney
Debbie Miller, Compliance Officer
Janie Binderim, Comptroller
Donna Singleton, HRPP Director
James Ponce, Director, Office of Internal Audit



APPENDIX A: MANAGEMENT'S RESPONSE

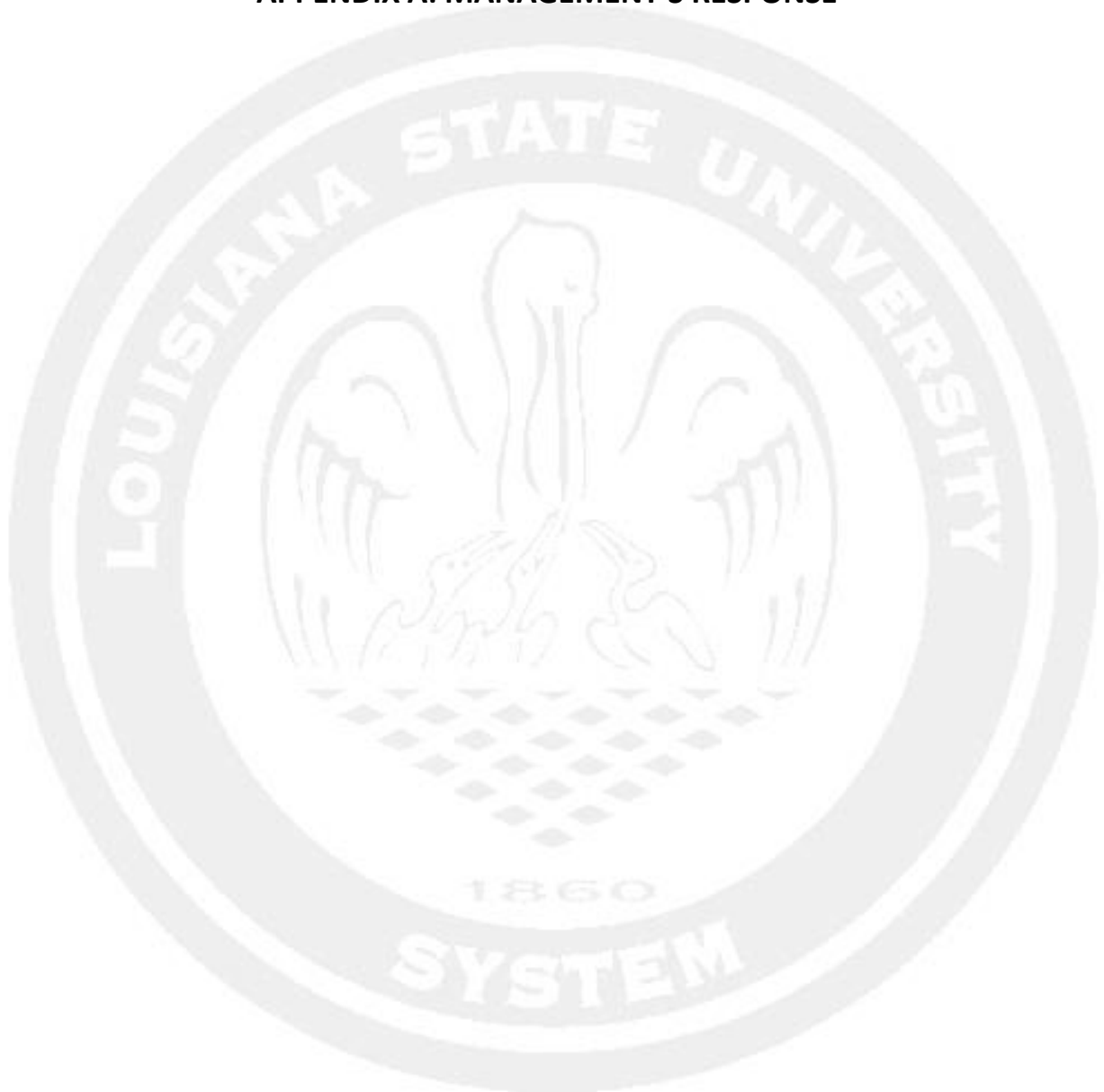

April 29, 2015

Chad M. Brackin, CPA, CFE
Chief Auditor
Louisiana State University System
3810 West Lakeshore Drive, Suite 122
Baton Rouge, Louisiana 70808



James Ponce, CPA, CIA, CFE
Director
Louisiana State University System
3810 West Lakeshore Drive, Suite 122
Baton Rouge, Louisiana 70808

Mr. Brackin / Mr. Ponce,

RE: Clinical Trials Internal Audit Response

FINDINGS, RECOMMENDATIONS, and RESPONSES

Finding No. 1: No executed master research agreement between HSC-S and the Biomedical Research Foundation

The master research agreement between HSC-S and the Biomedical Research Foundation (BRF) has not been finalized and executed. On October 1, 2013, the BRF commenced managing the hospital that was formerly part of HSC-S (medical university).

Patients treated at the hospital are a source of participants for the clinical trials conducted by the staff of the medical university. Since the BRF and HSC-S are two separate legal entities and have two separate management personnel, it is best business practice to have a written agreement between the two entities to specify the terms of the master research agreement.

The scope of the master research agreement is to enable the medical university to engage the BRF in obtaining services and utilizing facilities for research projects. HSC-S management has indicated that the master research agreement has not been completed because BRF management is reviewing the draft agreement.

Recommendation: We recommend that executive management establish a master research agreement with the Biomedical Research Foundation.

Response:

LSUHSC-S provided a draft master research agreement to University Health and BRF for consideration in January 2014. This agreement was not acceptable to BRF and therefore BRF provided a counter offer to LSUHSC-S. The agreement was not supportive toward the LSUHSC-S research mission, therefore the agreement was denied.

At a later time University Health leadership, compliance and legal was provided the original agreement for reconsideration. The agreement was agreed upon by the UH management team, including their attorney and compliance officer, but has yet to be signed off on by the BRF (who extends their FWA to University Health). LSUHSC-S continues to follow the direction of the LSU President.

Responsible personnel:

Executive leadership teams of University Health Hospital and LSUHSC-S.

Implementation date: Unknown

Finding No. 2: Financial monitoring of clinical trials is not adequate

Under the current financial process, HSC-S does not know whether the institution is recovering its cost related to clinical trials. Clarity in financial reporting is necessary to ensure the institution is managing state resources appropriately. We requested monitoring reports listing each clinical trial and current balance. The Feist-Weiller Cancer Center was able to provide a suitable report, however the bulk of trials performed at HSC-S were not included. HRPP was not able to provide a financial summary status of the trials.

Recommendation: We recommend that HSC-S establish a reporting mechanism through PeopleSoft or a clinical trial management system to provide management with quarterly reports of trial financial balances. Reporting should be used to ensure HSC-S is recovering its cost to conduct the clinical trials or is adequately identifying and approving self-funded research.

Response:

LSUHSC-S agrees that processes need improvement and best practices are not in place in every respect. Implementation of the software in use by Feist Weiller Cancer Center is under consideration with regards to funding; however, consideration must be given to the financial environment at this time. LSUHSC-S will conduct a test on two clinical trials utilizing the CTMS to determine the time involved and the FTE requirements needed to implement the CTMS across all human subject research. If it is determined that the clinical trials management system is not viable, LSUHSC-S will explore other methods to report and download financial data into Peoplesoft.

In addition, LSUHSC-S is developing a Peoplesoft report to capture all clinical trials to include old and/or non-active trials that do not include an identifiable chartstring field.

Responsible personnel: HRPP and Finance

Implementation date: 4th Quarter of Fiscal Year 2015-2016

Finding No. 3: Lack of a written financial closeout policy and procedures

HSC-S does not have a written financial closeout policy and procedures for sponsored projects. The audit results revealed that the internal controls were inadequate to ensure that HSC-S had been paid for medical services provided to research participants. In addition, there were inadequate procedures to ensure that trials closed by the IRB had been closed financially.

Medical Chart Reviews – Medical chart review procedures were inadequate to ensure that HSC-S was paid for medical services provided to the research participants. Test results showed that medical services were provided to participants of the HemaQuest, Clavis, and Otsuka clinical trials. However, Feist-Weiller Cancer Center (FWCC) management had not transferred \$2,513 to HSC-S for some of those services. In addition, an anti-seizure drug administered to one participant of the Otsuka clinical trial was not billed to Medicaid as part of standard of care. Without adequate controls, HSC-S is at risk of not receiving payment for medical services provided to the participants and not receiving payment for standard of care charges billed in accordance with federal regulations and national coverage decisions.

Unclosed Accounts – The PeopleSoft general ledger accounts for the HemaQuest, Clavis, Otsuka, and Nestle trials had not been closed. The IRB had approved the requests by the respective principal investigators to close all four of the trials.

Illustrated below is the length of days from the close trial date until our review of the general ledger accounts.

Trial Sponsor	Residual Balance	Date of IRB Closure	Days since close to 4/30/14
HemaQuest	17,885	6/21/2012	485
Clavis	14,989	5/22/2013	246
Otsuka	26,482	7/31/2013	196
Nestle	49,472	3/18/2014	32
Total	108,828		

The trials had not been closed to ensure (1) all services and deliverables contained in the contract had been completed (2) all revenues under the terms and conditions of the contract had been billed and collected, (3) all expenses of the contract had been paid and recorded in the general ledger and (4) termination of the account in the general ledger with adding a finite financial closure date to prevent any further recording of revenues or transfer of expenses from the account. As a result of the trials not being closed, they had residual balances totaling \$108,828.

Without financially closing the accounts, HSC-S risks expenditure of trial funds without compliance with state laws and university policies. The above errors occurred because of a lack of post-trial review. In addition, the Compliance Department position for the nurse auditor who performed the post-trial reviews for medical necessity and payment accuracy is vacant.

Recommendation: We recommend that executive management develop a written financial closeout policy and procedures for sponsored projects that accomplishes the four objectives above. We also recommend that executive management develop a written residual fund policy and procedures that ensures (1) the university has collected its indirect costs for the trial and (2) transfer of the residual funds to the respective department’s account by the end of the fiscal year in which the trial financially closes for use in accordance with state laws and university policies. These policies should be in-line with requirements at similar research institutions.

Response:

LSUHSC-S does not have a formal written policy regarding the close-out of clinical trials; however, the policy is being developed for a process to be implemented to assure at the departmental level that revenue was collected and expenses have been paid at the completion of the trial. Depending upon the department responsible for the trial, the appropriate Business Manager/or representative will be contacted to ensure this process is complete. In the long-term, this process will be addressed in the revision of the standard operating procedures. This policy will be finalized with guidance of LSU Legal Counsel.

Responsible personnel: HRPP, Finance, and Compliance

Implementation date: 4th Quarter Fiscal Year 2015-2016

Finding No. 4: Untimely cost transfers

Untimely cost transfers were made by HRPP from the Human Subject Research Support (HSRS) account to the clinical trials. There were 61 transfers totaling \$342,389 from the HSRS general ledger account to aged clinical trial accounts, a few of which had been closed by the IRB. Current transfers were made from clinical trials dated as far back as fiscal years 2003 and 2004.

Illustrated below is the total dollar amount of the transfers made in fiscal years 2013 and 2014.

Fiscal Year	No.	Amount Transferred
2013	54	\$ 316,808
2014	7	\$ 25,581
Total	61	\$ 342,389

Thirty-eight of the 61 contained documents to transfer \$201,792 in costs to those clinical trials. The cost transfers of \$201,792 included administrative expenses, such as postage and delivery and the salaries associated with these administrative expenses, such as processing pay vouchers.

This \$201,792 in administrative expenses is considered indirect costs. OMB Circular A-21 section F(6)(b) states: the salaries of administrative and clerical staff should normally be treated as indirect costs. OMB Circular A-21 section F(6)(B)(3) states that items such as office supplies, postage, local telephone costs, and memberships shall normally be treated as Facilities & Administrative (F&A) costs. Section B.4 of the Circular further states “F&A costs are synonymous with ‘indirect’ costs (IDC).”

In addition to charging these indirect costs, the university’s IDC rate was applied to some of these trials. As a result, some of these trials were charged an IDC amount and the amount of administrative expense, which is an inconsistent charging practice according to OMB Circular A-21.

A cost transfer involves moving an expense from one account to another. Transfers must be completed in a timely manner and require detailed documentation as to the reason for the transfer. Timeliness and completeness of the explanations of the transfers are important factors in supporting the allowance and allocation of the costs in accordance with the principles of OMB Circular A-21. HSC-S risks noncompliance with OMB Circular A-21 with the inaccurate classification and untimely transfer of indirect costs.

Section 2.1 of the Cost Accounting Standards Board Disclosure Statement (DS-2) states that HSC-S follows the guidelines in OMB Circular A-21 Section F.6.b. HSC-S management acknowledged that the cost transfers lacked timeliness.

Recommendation:

We recommend that accounting management develop procedures to ensure that cost transfers are completed in the appropriate fiscal year. In addition, a formal approval process needs to be established to ensure there is adequate oversight of the cost transfers.

Response:

LSUHSC-S agrees there were untimely transfers made to reimburse Human Subject Research Support for work conducted over several years. This department supports and provides the research infrastructure to many departments on campus. This delay in transferring costs is not the normal procedure followed and occurred as a result of an internal review of the outstanding study accounts that had not been reconciled when oversight changed. Going forward transfers will also be approved by the Principal Investigator or Department Chair. This process to ensure that cost transfers are completed in the applicable fiscal years will be addressed in the revision of policies supporting financial oversight of Clinical Trials.

Responsible personnel: HRPP, Finance and Compliance

Implementation date: 4th Quarter Fiscal Year 2015-2016

Finding No. 5: General ledger accounts not established for clinical trials

PeopleSoft® (PS) general ledger accounts were not established according to the HSC-S Guidelines for Clinical Research (dated 5/11/01). The Guidelines require that when the first payment arrives from the company, the IRB fee will be collected and an account will be established for the project.

There was no general ledger account for four of the trials tested - Pharmaceutical Research Associates (PRA), Pfizer, Mauna Kea Technologies (MKT), and the LSU ICON project. Documents show that:

- IRB fees had been received for all four trials
- The Pfizer and PRA trials had received \$3,200 and \$3,000 in payments, respectively
- The MKT trial had enrolled 17 participants

An interagency agency transfer of \$3,000 had been made from the Neurosurgery Department to the Neurology department for the PRA trial as a reimbursement of expenses. The \$3,200 for the Pfizer trials was a sponsor payment and had been deposited to a clearing account. Without establishing a general ledger account to recording the payments and expenses for each trial, HSC-S risks inaccurately reporting its revenues, expenses and fund balances in the university's financial statements.

The MKT trial had 17 participants and was incurring effort, but no payment had been received on the trial. Invoices had not been completed since the contract was signed in July 2013 to receive payment for the LSU ICON project. As a result, HSC-S risks using state general funds to cover the costs related to these projects.

Recommendation: We recommend Grants Accounting management establish general ledger accounts for the clinical trials immediately following IRB approval. Trial related revenues and expenses should be recorded directly to the trial account in a timely manner to ensure accurate balances are available for the monitoring report in recommendation No. 2.

Response:

- 1) The accounting policy for IRB and Pharmacy Fees has been in place for many years. IRB and Pharmacy Fees are considered institutional funds and are recorded in institutional chartstring and therefore not study specific.
- 2) One study picked for the sample was a grant and not clinical trial. The support identifying the sample as a grant has been provided.

Accounting does not open a research account until funds are received, rather than opening a research account upon every IRB approval. This avoids opening accounts for studies which never enroll participants. When funds are received for payment of IRB fees these funds are immediately placed in the IRB fee account.

To address the future reporting needs, LSUHSC-S will conduct a test on two clinical trials utilizing the Clinical Trials Management System to determine the time involved and the FTE requirements needed to implement the CTMS across all human subject research. If it is determined that the clinical trials management system is not viable, LSUHSC-S will explore other methods to report and download financial data into Peoplesoft.

Responsible personnel: Accounting Services and HRPP

Implementation date: 4th Quarter Fiscal Year 2015-2016

Finding No. 6: Lack of a written cost policy and procedures

There is a lack of a written cost policy and procedures. The audit results showed that direct costs were not consistently recorded to the trials. The time and effort forms for some of the researchers showed that effort was expended on privately sponsored clinical trials. However, the direct costs, such as salaries and fringe benefits, were not allocated to the trials.

In addition, the study coordinators' salaries and fringe benefits were inconsistently recorded to the clinical trials. The study coordinators' salaries and benefit were recorded for three of the trials (H11-037, H12-107, and H13-054). However, the study coordinators' salaries and benefits were not recorded for the remaining three trials (H10-094, H11-005, and H11-095).

The test results also revealed an incomplete payment to a trial participant. A participant for H11-095 trial should have been paid \$240; however, he was only paid \$210. The participant was not paid for his week 16 visit of \$30 according to the protocol budget.

The Cost Accounting Standards Board Disclosure Statement for HSC-S (DS-2) states in section 2.1 that costs that can be identified specifically with a particular sponsored project, instructional activity, or other institutional activity, or can be directly assigned to such activities relatively easily with a high degree of accuracy are treated as direct costs. It further states that every effort is made to classify costs incurred for the same purpose, in like circumstances, consistently as either direct or indirect costs.

The internal controls are not adequate to assure that all direct costs are recorded to the sponsored projects. As a result, the financial performances of these trials are not accurately recorded in the PeopleSoft Accounting System.

Recommendation:

We recommend that executive management develop:

- A) Written cost policies and procedures that are consistent with OMB Circulars A-21 and DS-2. Until this is done, HSC-S risks a technical violation in a federal audit without accurately and completely recording the direct costs to sponsored projects. These policies should be in-line with requirements at similar research institutions.

B) Controls to ensure budgeted net gains or losses for clinical trials are formally approved by the PI before conducting the trial. Budgets should include all expected revenues and expenses, including PI percent effort. By not currently including PI salary costs, the institution is at risk of not fully covering the cost of private research, thereby funding private research with state dollars.

Response:

Written cost policies and procedures are being developed. These policies will address the potential allocation of the Principal Investigator's salary cost with the intent of insuring the Institution is recovering all related costs associated with the clinical trial.

Based upon available institutional funding, a Clinical Trials Management System is being considered for next fiscal year.

Responsible personnel: Executive Leadership Team

Implementation date: 4th Quarter Fiscal Year 2015-2016

If additional information is needed, please do not hesitate to advise.

Sincerely,



Robert A. Barish, MD, MBA
Chancellor

RAB/ddc



Board of Supervisors

MEETING MINUTES

BOARD OF SUPERVISORS MEETING | OCTOBER 28-29, 2021

MINUTES
LSU BOARD OF SUPERVISORS MEETING
*Board Room, University Administration Building
3810 West Lakeshore Drive, Baton Rouge, LA 70808
Friday, September 10, 2021 | Time: 10:00 a.m. CT*

I. Call to Order and Roll Call

Mr. Robert Dampf, Chair, called to order the Regular Meeting of the Board of Supervisors of Louisiana State University and Agricultural and Mechanical College on September 10, 2021.

Present

Mr. Robert Dampf, Chair
Mr. Rémy Voisin Starns, Chair-elect
Ms. Mary Leach Werner, Past Chair
Ms. Monica Aguilera
Mr. Glenn Armentor
Ms. Laurie Aronson
Mr. Wayne Brown
Mr. Jay Blossman
Ms. Valencia Sarpy Jones
Mr. Lee Mallett
Mr. Randy Morris
Mr. Patrick C. Morrow
Mr. Collis Temple Jr.
Mr. Jimmie Woods
Mr. Richard Zuschlag

Absent

Mr. James Williams

Also participating in the meeting were the following: Dr. William F. Tate IV, President of LSU; Mr. Winston DeCuir, General Counsel for LSU; University officer and administrators of the campuses; faculty and staff representatives; interested citizens and representatives of the news media.

II. Invocation and Pledge of Allegiance

The invocation was offered by Mr. Kevin George, Director of the University Lab School.

The Pledge of Allegiance was led by Ms. Catherine Rosenfeld's kindergarten class from the University Lab School.

III. Public Comment

There were twelve individuals registered for public comment.

Robert Mann made comments related to Item 1 on the Academic & Research Committee.

The following individuals made comments related to Item 7 on the Academic & Research Committee, Resolution to Name Court for Dale Brown: Javin Bowman, Sen. Stewart Cathey, Jordy Hultberg, Ricky Blanton, Rev. Cary Hughes, Rudy Macklyn, Trent Angers, John Brody, and Jim Engster.

Motion by Mr. Armentor to suspend the rules and to take up agenda item IV, A, 7, the Dale Brown Court Naming, out of order and have the item considered by the full Board. The motion was seconded by Mr. Temple.

Objection to the motion by Ms. Werner. With 11 yeas and 4 nays, the motion carried.

Motion by Ms. Aguilera to revise the resolution to name the court after Dale Brown and Sue Gunter. The motion was seconded by Ms. Werner. With 3 yeas and 12 nays, the motion failed.

Motion by Ms. Aguilera to table the original resolution. Motion seconded by Ms. Jones. With 4 yeas and 11 nays, the motion failed.

Roll call vote on the original motion to name the court for Dale Brown. With a vote of 12 yeas and 3 nays, the resolution was approved.

NOW, THEREFORE, BE IT RESOLVED, the Board of Supervisors of Louisiana State University and Agricultural & Mechanical College does hereby name the men's basketball court in the Pete Maravich Assembly Center to be named for Dale Brown and will hereafter be referred to as "Dale Brown Court".

IV. Committee Meetings

Mr. Dampf adjourned the regular meeting to convene the committee meetings.

4.A. **Academic Committee**

Present for the Academic Committee were Ms. Jones, Ms. Aguilera, Mr. Armentor, Ms. Aronson, Mr. Blossman, Mr. Starns, and Ms. Werner.

Ms. Jones presented several accolades the University received.

4.A.1. Request to Amend Board Regulations

Item deferred.

4.A.2. Request to Reauthorize the Admissions Policies Related to Standardized Tests for a Limited Term for All LSU Campuses

Upon motion by Mr. Starns, seconded by Ms. Aronson, the item was approved without objection.

NOW, THEREFORE, BE IT RESOLVED the Board of Supervisors of Louisiana State University and Agricultural & Mechanical College (the "Board") does hereby approve the extension of the authorization to remove the requirement of a standardized test score to apply to terms and sessions starting in Academic Year 2022-23 for all LSU campuses.

4.A.3. Request from LSU Health Sciences Center – Shreveport for a Letter of Intent for the Bachelor of Science in Cardiovascular Technology

Upon motion by Ms. Aguilera, seconded by Mr. Armentor, the item was approved without objection.

NOW, THEREFORE, BE IT RESOLVED that the Board of Supervisors of Louisiana State University and Agricultural & Mechanical College does hereby approve the request from LSU Health Sciences Center – Shreveport for a Letter of Intent for the Bachelor of Science in Cardiovascular Technology.

4.A.4. Request from LSU Health Sciences Center – Shreveport for Approval of Mission Statement

Upon motion by Ms. Aronson, seconded by Mr. Starns, the item was approved without objection.

NOW, THEREFORE, BE IT RESOLVED that the Board of Supervisors of Louisiana State University and Agricultural & Mechanical College does hereby approve the revised mission statement from LSU Health Sciences Center – Shreveport to be as follows:

The primary mission of Louisiana State University Health Sciences Center at Shreveport (LSUHSC-S) is to TEACH, HEAL and DISCOVER, in order to advance the well-being of the State, region, and beyond. LSUHSC-S encompasses the Schools of Medicine, Graduate Studies and Allied Health Professions in Shreveport.

To implement its mission, LSUHSC-S is committed to:

- Prepare learners for careers in health care service, teaching and research using state-of-the-art curricula, methods, and facilities.
- Provide a growing, diverse regional patient population with state-of-the-art clinical care, including a range of tertiary special services.
- Achieve distinction and international recognition for basic science and clinical research programs that contribute to the body of knowledge and practice of science and medicine.
- Utilize research and knowledge to support economic growth and prosperity of the region and State by engaging in productive partnerships with the private sector.
- Foster a culture of diversity and inclusion that promotes mutual respect for all.

4.A.5. Request from LSU A&M to Establish an Undergraduate Certificate in Construction Management

Upon motion by Mr. Armentor, seconded by Mr. Blossman, the item was approved without objection.

NOW, THEREFORE, BE IT RESOLVED that the Board of Supervisors of Louisiana State University and Agricultural & Mechanical College does hereby approve the request from LSU A&M to establish an Undergraduate Certificate in Construction Management.

4.A.6. Request from Pennington Biomedical Research Center for Support of the Renewal Application of the Louisiana Clinical and Translational Science Center for the NIH IDeA Grant

Upon motion by Ms. Aguilera, seconded by Ms. Aronson, the item was approved without objection.

NOW, THEREFORE, BE IT RESOLVED the Board of Supervisors of Louisiana State University and Agricultural & Mechanical College (the “Board”) does hereby declare that it recognizes and

supports the collective efforts of the institutions of the Louisiana State University institutions that are collaborating in the Louisiana Clinical and Translational Science Center and encourages those collaboration with other Louisiana higher education institutions engaged in clinical and translational research; and,

BE IT FURTHER RESOLVED, that the Board of Supervisors of the Louisiana State University and Agricultural and Mechanical College recognizes the Louisiana Clinical and Translational Science Center at Pennington Biomedical Research Center to be the lead institution for the award of a National Institutes of Health IDeA Clinical and Translational Research Center.

4.A.7. Resolution to Name Court for Dale Brown

Item taken up prior to Committee Meeting

4.A.8. Request from LSU A&M to Name the Ochsner Wellness Center in the Huey P. Long Fieldhouse

Upon motion by Mr. Armentor, seconded by Ms. Aguilera, the item was approved without objection.

NOW, THEREFORE, BE IT RESOLVED the Board of Supervisors of Louisiana State University and Agricultural & Mechanical College (the "Board") does hereby name the wellness facility within the Huey P. Long Fieldhouse as the "Ochsner Wellness Center".

4.B. Finance Committee

Present for the Finance Committee were Mr. Brown, Mr. Woods, Ms. Aronson, Mr. Blossman, Mr. Mallett, Mr. Morris, Mr. Temple, and Mr. Zuschlag.

4.B.1. Recommendation to Approve the Fiscal Year 2021-2022 Operating Budget

Upon motion by Mr. Zuschlag, seconded by Mr. Morris, the item was approved without objection.

NOW, THEREFORE, BE IT RESOLVED that the Board of Supervisors of Louisiana State University and Agricultural & Mechanical College does hereby approve the operating budget for the fiscal year ending June 30, 2022, providing:

- a) Final approval and commitment authorization of funds for unrestricted educational and general, medical, and related expenses in the amount of \$1,190,016,205 for the campuses shown below.

LSU A&M LSU Agricultural Center
LSU Alexandria
LSU Eunice
LSU Shreveport
LSU Health Sciences Center, New Orleans
LSU Health Sciences Center, Shreveport
LSU Pennington Biomedical Research Center
The Hospital and Central Office of the LSU Health Care Services Division

- b) Commitment authorizations for auxiliary enterprises, grants and contracts, and other restricted funds estimated to be \$1,964,876,382.

- c) Transactions included or referred to in the operating budget that otherwise require Board approval are not approved by mere inclusion in the operating budget.

BE IT FURTHER RESOLVED that each campus shall prepare a semi-annual financial report. The format of the report will include the following:

1. Budget and actual for unrestricted revenues by source of funds
2. Actual for unrestricted expenditures by object and by function
3. Beginning account balances and actual revenues and expenditures/transfers for restricted operations
4. Any significant changes in the budget that should be brought to the attention of the President and Board
5. An explanation of any significant reduction in anticipated revenues or significant increase in expenditures

Any subsequent modification to the reporting format will be approved by the President with notification to the Board.

4.C. Property & Facilities Committee

Present for the Property & Facilities Committee were Mr. Woods, Mr. Brown, Ms. Aronson, Mr. Armentor, Ms. Jones, Mr. Mallett, Mr. Morris, and Mr. Temple.

- 4.C.1. Request for the Approval of the FY 2022-2023 Five-Year Capital Outlay Budget Request and First Year Prioritized List for Louisiana State University

Upon motion by Mr. Brown, seconded by Mr. Temple, the item was approved without objection.

NOW, THEREFORE, BE IT RESOLVED by the Board of Supervisors of Louisiana State University and Agricultural and Mechanical College that the following list of projects to be submitted to the Division of Administration in accordance with the provisions of La. R.S. 39:101 et seq. and first year prioritized project list is approved and;

BE IT FURTHER RESOLVED, that the President of Louisiana State University, or their designee, is hereby authorized to make adjustments as necessary in this request as circumstances dictate, including technical corrections, increasing or decreasing the amount requested for individual projects by not more than twenty percent (20%) of the amount approved in this resolution, combining or renaming projects and/or changing sources of funds and to add self-generated projects with individual project costs of less than \$1 million without further approval by the Board, provided, however, that such project additions be reported to the Board.

BE IT FURTHER RESOLVED that transactions included or referred to in the capital outlay request that otherwise require Board approval are not approved by inclusion in the capital outlay request per Article VII, Section 2A of the Bylaws.

- 4.C.2. Request from Pennington Biomedical for Approval of Agreements Related to Development of a Center of Excellence for Bariatric/Metabolic Surgery

Upon motion by Mr. Morris, seconded by Mr. Mallett, the item was approved without objection.

NOW, THEREFORE, BE IT RESOLVED that the Board of Supervisors does hereby, authorize the President of Louisiana State University, or their designee, on behalf of Pennington Biomedical

Research Center, and in consultation with the General Counsel's Office, to execute the lease as presented with Our Lady of the Lake Physicians Group. BE IT FURTHER RESOLVED, the President is authorized to make adjustments to the lease determined to be in the best interest of the University.

4.D. Healthcare & Medical Education Committee

Present for the Healthcare & Medical Education Committee were Mr. Morris, Ms. Jones, Mr. Armentor, Mr. Blossman, Mr. Brown, Mr. Morros, Mr. Starns, Mr. Woods, and Mr. Zuschlag.

4.D.1. Request for Amendment of Contracts with Ochsner/LSU Health Shreveport Health System

Upon motion by Mr. Morris, seconded by Mr. Mallett, the item was approved without objection.

NOW, THEREFORE, BE IT RESOLVED the Board of Supervisors of Louisiana State University and Agricultural & Mechanical College (the "Board") does hereby authorize the President, in consultation with the General Counsel, to execute the Second Amendment to Academic Affiliation Agreement, First Amendment to Professional Services Agreement, First Amendment to Faculty Services Agreement, First Amendment to Academic and Clinical Collaboration Agreement, First Amendment to Shared Services Agreement, and the Settlement Agreement as presented to the Board on September 10, 2021, and to authorize the President to make any subsequent amendments to the presented contracts, that the President deems in the best interest of LSU.

4.E. Athletics Committee

Present for the Athletics Committee were Ms. Werner, Mr. Temple, Mr. Blossman, Mr. Brown, Ms. Jones, Mr. Morrow, Mr. Starns, Mr. Woods, and Mr. Zuschlag.

4.E.1. Request from LSU A&M to Approve Contract of Jay Johnson, Baseball Head Coach

NOW, THEREFORE, BE IT RESOLVED that the Board of Supervisors of Louisiana State University and Agricultural & Mechanical College authorizes the President, or his designee, to sign the contract with Jay Johnson as described in this item, and to include in such amendments any terms and conditions as he, in consultation with the General Counsel, deems to be in the best interests of LSU.

4.E.2. Request from LSU A&M to Approve Contract with Rick Bishop, Swimming & Diving Co-Head Coach

Motion to approve Items 1 and 2 by Mr. Zuschlag; seconded by Mr. Morrow. Without objection, the motion passed.

4.E.3. Request from LSU A&M to Amend Contract with Dennis Shaver, Track & Field Head Coach

Item 3 was removed from the agenda.

4.E.4. Request from LSU Alexandria to Approve the Employment Contract with Harrison Houle, Head Coach of Women's Soccer

Upon motion by Ms. Jones, seconded by Mr. Morrow, the item was approved without objection.

NOW, THEREFORE, BE IT RESOLVED that the Board of Supervisors of Louisiana State University and Agricultural and Mechanical College does hereby authorize the President of LSU, or his designee, to execute the employment agreement with Harrison Houle as presented; and,

BE IT FURTHER RESOLVED that the President of LSU, or his designee, be and he is hereby authorized by and empowered for and on behalf of and in the name of the Board of Supervisors, in consultation with General Counsel, to include in the Agreement any and all provisions and stipulations that he deems in the best interest of the University.

V. Reconvene Board Meeting

The regular meeting was called to order.

VI. Approval of Minutes from the August 6, 2021 Board Meeting

Upon motion by Mr. Mallett, seconded by Mr. Zuschlag, the Board voted unanimously to approve the minutes of the August 6, 2021 meeting.

VII. Reports to the Board

- A. LSU Semi-Annual Financial Report for the Six-Month Period Ending June 30, 2021
- B. Annual Audit Report

Upon motion by Mr. Mallett, seconded by Mr. Morrow, the Board voted unanimously to approve the report.

VIII. Reports from Faculty Advisors and Staff Advisors

Dr. Mandi Lopez reported on behalf of the Faculty Advisors.

The Staff Advisors submitted a written report.

IX. President's Report

President Tate provided an informational report.

X. Approval of Committee Recommendations

Upon motion by Ms. Jones, seconded by Ms. Werner, the Board voted unanimously to approve the committee recommendations.

XI. Chair's Report

Mr. Dampf provided his last report as Chairman, thanking individuals for a great year.

XII. Oath of Office for Chair

Mr. Starns was sworn in as Chair by his wife, Mrs. Pam Starns.

XIII. Election and Oath for Chair-Elect

The floor was opened for nominations. Mr. Woods made a motion to nominate Ms. Jones as Chair-elect. The motion was seconded by Mr. Dampf. Without further names, the nomination process was closed. Without objection, Ms. Jones was unanimously voted as Chair-elect.

Ms. Jones was sworn in by Mr. Starns.

The following resolution was read into record.

WHEREAS, Mr. Robert S. Dampf has been a proud LSU Tiger all of his life and graduated from the LSU Paul M. Hebert Law Center; and

WHEREAS, Mr. Dampf was appointed to the LSU Board of Supervisors on June 5, 2018 by Governor John Bel Edwards and was duly confirmed by the Louisiana Senate; and

WHEREAS, Mr. Dampf was elected Chair-Elect by acclamation of his peers and become Chair on September 11, 2020; and,

WHEREAS, when Mr. Dampf became Board Chair, the United States and the world were in the midst of the SARS-COVID-19 pandemic unseen since the Spanish Flu pandemic, which resulted in the University broadcasting all courses for the fall 2020 semester; and,

WHEREAS, members of the media brought claims to light about the handling of Title IX cases, forcing great introspection on the part of the University and requiring wholesale change in the approach to Title IX enforcement and compliance; and,

WHEREAS, the University was in need of a president and Mr. Dampf appointed a search committee that resulted in the identification of William F. Tate, IV; and,

WHEREAS, during his tenure as Chair, the University mounted the most vigorous COVID-19 mitigation strategy among its peers; and,

WHEREAS, with his support as Chair and that of the Board as a whole, the University is nearing completion of the Title IX transformation to make it a model in the nation; and,

WHEREAS, LSU initiated a once-in-a-generation program to overhaul the utilities infrastructure of the campus in Baton Rouge, a negotiation benefitting from Mr. Dampf's leadership and skill; and,

WHEREAS, Mr. Dampf was a great mediator of opinions and took great care in hearing the concerns of all members and working vigorously to build consensus; and,

WHEREAS, Mr. Dampf used those mediation skills to work tirelessly in support of the University to great positive impact.

THEREFORE BE IT RESOLVED, the colleagues of Mr. Robert S. Dampf who serve on the Board of Supervisors of Louisiana State University and Agricultural & Mechanical College do hereby convey their gratitude and appreciation for his loyalty and ferocity advocating for the University; and,

BE IT FURTHER RESOLVED, those same colleagues are grateful to Mrs. Courtney Dampf for supporting her husband during his work with the Board, herself serving as a great ambassador for the University, and opening her home to further our cause.

XIV. Adjournment

With no further business before the Board, the meeting was adjourned.



Board of Supervisors

PERSONNEL ACTIONS REQUIRING BOARD APPROVAL

BOARD OF SUPERVISORS MEETING | OCTOBER 28-29, 2021

Personnel Actions Requiring Board Approval
per PM-69

October 29, 2021

Personnel Actions Requiring Board Approval per PM-69
October 29, 2021

LSU A&M
New Appointments

<u>Name</u>	<u>Title</u>	<u>Effective Date</u>	<u>Compensation</u>		<u>%Change</u>
			<u>Current</u>	<u>Proposed</u>	
Paul Mainieri	Ambassador to the Athletics Department	7/3/2021	N/A	\$100,000	N/A



Board of Supervisors

REPORTS TO THE BOARD

BOARD OF SUPERVISORS MEETING | OCTOBER 28-29, 2021



Board of Supervisors

Finance Committee
Fall 2021 Enrollment

Written Report Only

To: Members of the Board of Supervisors

Date: October 29, 2021

The following is a summary report that compares Fall 2020 enrollment to Fall 2021 enrollment. Additional details are included in **Table 1** attached to this report.

LSU A & M:

- The number of new first-time freshmen increased. Fall 2020 (6,701) and Fall 2021 (7,045)
- Total undergraduate headcount increased. Fall 2020 (27,948) and Fall 2021 (29,386)
- The number of graduate students enrolled increased. Fall 2020 (5,249) and Fall 2021 (5,378)
- The number of professional students enrolled increased. Fall 2020 (495) and Fall 2021 (519)
- The number of law students enrolled increased. Fall 2020 (598) and Fall 2021 (631)
- Total headcount enrollment increased. Fall 2020 (34,290) and Fall 2021 (35,914)
- The number of freshmen applications increased. Fall 2020 (28,874) and Fall 2021 (36,424)
- First to second year retention decreased. Fall 2020 (85.8% for Class of 2019) and Fall 2021 (82.9% for Class of 2020)

LSU Alexandria:

- The number of new first-time freshmen decreased. Fall 2020 (462) and Fall 2021 (420)
- Total undergraduate headcount increased. Fall 2020 (3,500) and Fall 2021 (3,770)
- The number of freshmen applications decreased. Fall 2020 (1,243) and Fall 2021 (1,041)
- First to second year retention increased. Fall 2020 (61.00% for Class of 2019) and Fall 21 (61.40% for Class of 2020)

LSU Eunice:

- The number of new first-time freshmen decreased. Fall 2020 (880) and Fall 2021 (768)
- Total undergraduate headcount decreased. Fall 2020 (2,581) and Fall 2021 (2,435)
- The number of freshmen applications decreased. Fall 2020 (2,648) and Fall 2021 (2,265)
- First to second year retention decreased. Fall 2020 (51.32% for Class of 2019) and Fall 2021 (45.75% for Class of 2020)

LSU Shreveport:

- The number of new first-time freshmen decreased. Fall 2020 (342) and Fall 2021 (306)
- Total undergraduate headcount decreased. Fall 2020 (2,365) and Fall 2021 (2,244)
- Total graduate headcount decreased. Fall 2020 (7,288) and Fall 2021 (6,363)
- Total headcount enrollment decreased. Fall 2020 (9,653) and Fall 2021 (8,607)
- The number of freshmen applications increased. Fall 2020 (1,222) and Fall 2021 (1,374)
- First to second year retention decreased. Fall 2020 (63.14% for Class of 2019) and Fall 2021 (62.65% for Class of 2020)

LSU Health Sciences Center New Orleans:

- Total headcount enrollment increased. Fall 2020 (2,827) and Fall 2021 (2,835)

LSU Health Sciences Center Shreveport:

- Total headcount enrollment increased. Fall 2020 (966) and Fall 2021 (1,003)

Table I
Fall 2021 14th Day Enrollment Report

LSU A&M

Undergraduate/First Time Freshmen/Fall	14th Day Fall 2020	14th Day Fall 2021	% Increase (Decrease)
# of applications	28,874	36,424	26.15%
# enrolled	6,701	7,045	5.13%
Number of nonresident students enrolled	1,794	2,202	22.74%

LSU A & M Honors College			
Undergraduate/First Time Freshmen/Fall	14th Day Fall 2020	14th Day Fall 2021	% Increase (Decrease)
# of applications	7,159	15,367	114.65%
# enrolled	807	809	0.25%
Number of nonresident students enrolled	240	210	(12.50%)

Undergraduate/Transfers BOR Defined	14th Day Fall 2020	14th Day Fall 2021	% Increase (Decrease)
# enrolled	928	923	(0.54%)
Transfers enrolled from LA Community Colleges	209	219	4.78%
Transfer enrolled from LA 4-year universities	282	283	0.35%

	14th Day Fall 2020	14th Day Fall 2021	% Increase (Decrease)
Undergraduate Headcount	27,948	29,386	5.15%
Dual Enrollment	2,460	2,615	6.30%
Graduate Student Headcount	5,249	5,378	2.46%
Professional	495	519	4.85%
Professional - Law	598	631	5.52%
Total headcount	34,290	35,914	4.74%

	14th Day Fall 2020	14th Day Fall 2021	% Difference
1 st to 2 nd Year Retention First Time Full Time Freshmen (Class 2019 & Class 2020)	85.8%	82.9%	-2.90%

	14th Day Fall 2020	14th Day Fall 2021	% Increase (Decrease)
New Freshman Male Headcount	2,953	2,961	0.27%
New Freshman Female Headcount	3,748	4,084	8.96%

New Graduate/Professional/Law	14th Day Fall 2020	14th Day Fall 2021	% Increase (Decrease)
# Graduates Enrolled	1,175	1,158	(1.45%)
# Professional Enrolled	119	120	0.84%
# Professional-Law Center Enrolled	209	241	15.31%

Table I
Fall 2021 14th Day Enrollment Report

LSU Alexandria

Undergraduate/First Time Freshmen/Fall	14th Day Fall 2020	14th Day Fall 2021	% Increase (Decrease)
# of applications	1,243	1,041	(16.25%)
# of students enrolled	462	420	(9.09%)

Undergraduate/Transfers BOR Defined	14th Day Fall 2020	14th Day Fall 2021	% Increase (Decrease)
# enrolled	449	507	12.92%
Transfers enrolled from LA Community Colleges	101	118	16.83%
Transfer enrolled from LA 4-year universities	110	122	10.91%

Undergraduate Headcount	14th Day Fall 2020	14th Day Fall 2021	% Increase (Decrease)
Undergraduate Headcount	3,500	3,770	7.71%
Dual Enrollment	461	572	24.08%

1st to 2nd Year Retention First Time Full Time Freshmen (Class 2019 & Class 2020)	14th Day Fall 2020	14th Day Fall 2021	% Difference
1st to 2nd Year Retention First Time Full Time Freshmen (Class 2019 & Class 2020)	61.00%	61.40%	+0.40%

New Freshman Headcount	14th Day Fall 2020	14th Day Fall 2021	% Increase (Decrease)
New Freshman Male Headcount	173	159	(8.09%)
New Freshman Female Headcount	289	261	(9.69%)

Table I
Fall 2021 14th Day Enrollment Report

LSU Eunice

Undergraduate/First Time Freshmen/Fall	14th Day Fall 2020	14th Day Fall 2021	% Increase (Decrease)
# of applications	2,648	2,265	(14.46%)
# enrolled	880	768	(12.73%)

	14th Day Fall 2020	14th Day Fall 2021	% Increase (Decrease)
Undergraduate Headcount	2,581	2,435	(5.66%)
Dual Enrollment	561	588	4.81%

	14th Day Fall 2020	14th Day Fall 2021	% Difference
1st to 2nd Year Retention First Time Full Time Freshmen (Class 2019 & Class 2020)	51.32%	45.75%	-5.57%

	14th Day Fall 2020	14th Day Fall 2021	% Increase (Decrease)
New Freshman Male Headcount	254	218	(14.17%)
New Freshman Female Headcount	629	550	(12.56%)

Table I
Fall 2021 14th Day Enrollment Report

LSU Shreveport

Undergraduate/First Time Freshmen/Fall	14th Day Fall 2020	14th Day Fall 2021	% Increase (Decrease)
# of applications	1,222	1,374	12.44%
# of students enrolled	342	306	(10.53%)

Undergraduate/Transfers BOR Defined	14th Day Fall 2020	14th Day Fall 2021	% Increase (Decrease)
# enrolled	338	316	(6.51%)
Transfers enrolled from LA community colleges	123	129	4.88%
Transfers enrolled from LA 4-year universities	83	71	(14.46%)

	14th Day Fall 2020	14th Day Fall 2021	% Increase (Decrease)
Undergraduate Headcount	2,365	2,244	(5.12%)
Dual Enrollment	224	258	15.18%
Graduate Student Headcount	7,288	6,363	(12.69%)
Total headcount	9,653	8,607	(10.84%)

	14th Day Fall 2020	14th Day Fall 2021	% Difference
1st to 2nd Year Retention First Time Full Time Freshmen (Class 2019 & Class 2020)	63.14%	62.65%	-0.49%

	14th Day Fall 2020	14th Day Fall 2021	% Increase (Decrease)
New Freshman Male Headcount	142	132	(7.04%)
New Freshman Female Headcount	200	174	(13.00%)

Report to LSU Board of Supervisors: Capital Improvements Projects above \$175,000
All Campuses Last 3 Years

Updated October 11, 2021

	2021-2022		AMOUNT APPROVED	FUNDS SOURCE	APPROVED BY	APPROVAL DATE
LSU	French House Honors College Site & Landscaping Improvements Phase 1a		\$460,000	Ancillary Self Generated Revenue	Interim Exec. VP Torres	09/07/21
	Life Sciences Annex-Waterproof E & N Water Infiltration Study		\$495,000	Operational Funds	Interim Exec. VP Torres	07/02/21
Total LSU			\$955,000			
LSUS	Bronson Hall Elevator Equipment & cab Upgrades		\$290,000	Operational Funds	Interim Exec. VP Torres	07/26/21
	HPE Building Equipment Pavilion Climate Chamber budget additional funds added to original \$203,000		\$92,000	Operational Funds	Interim Exec. VP Torres	07/05/21
Total LSUS			\$382,000			
TOTAL CAPITAL PROJECTS APPROVALS 2020-2021			\$1,337,000			

**Report to LSU Board of Supervisors:
All Campuses Last 3 Years**

Capital Improvements Projects above \$175,000

Updated October 11, 2021

	2020-2021	AMOUNT APPROVED	FUNDS SOURCE	APPROVED BY	APPROVAL DATE
LSU	Alex Box Champions Club Seating Replacement	\$225,000	Self-Generated	Interim Exec. VP Torres	04/22/21
	Chemistry & Materials Building: Room 122 Renovations	\$276,901	Self-Generated	Exec. VP Layzell	09/05/20
	Chemical Engineering Building Shop Renovation	\$225,000	Operational Funds	Interim Exec. VP Torres	06/27/20
	Design Building Boyce Gallery	\$220,000	Operational Funds	Interim Exec. VP Torres	04/28/21
	Firing Range Facility rebid	\$375,000	Operational Funds/Other Funds	Exec. VP Layzell	09/15/20
	Hill Memorial Library room 108 & 109 Renovations	\$348,000	Foundation Funds	Interim Exec. VP Torres	04/01/21
	Hodges Hall 119-132A-132D-148-150 Renovations	\$220,000	Operational Funds	Interim Exec. VP Torres	04/01/21
	Jesse Coates 3rd Floor Biology Lab Renovations	\$495,000	Other Ancillary self-generated revenues	Interim Exec. VP Torres	12/16/20
	PERTT Lab Phase 2 Electrical Renovations	\$200,000	Other Ancillary self-generated revenues	Interim Exec. VP Torres	11/10/20
	SVM Chiller Replacement	\$950,000	Operational Funds	Interim Exec. VP Torres	12/16/20
	SVM Water Line Replacement	\$225,000	Operational Funds	Exec. VP Layzell	09/15/20
	Thomas Boyd Hall Office of the Bursar Renovation 2021	\$185,000	Cares Act Funding	Interim Exec. VP Torres	04/22/21
	University Stores Renvations for Parking & Transportation	\$730,000	Other Ancillary self-generated revenues	Interim Exec. VP Torres	12/16/20
Total LSU		\$4,674,901			
LSUS	Noel Library Student Development Suite	\$318,000	Operational Funds	Interim Exec. VP Torres	03/08/21
	HPE Building Equipment Pavilion Climate Chamber	\$203,000	Operational Funds	Interim Exec. VP Torres	03/29/21
	Science Building & Technology Center Building Emergency Power System	\$305,000	Tuition & Fees	Exec. VP Layzell	10/22/20
	Sports Fields Drainage Improvements (Options A,B,C)	\$202,298	Operational Funds	Interim Exec. VP Torres	04/09/21
	Technology Center Air Handling Unit Replacement Budget Increase Additonal Funds	\$135,000	Operational Funds	Interim Exec. VP Torres	04/22/21
	Technology Center Air Handling Unit Replacement	\$360,000	Operational Funds	Interim Exec. VP Torres	01/15/21
		\$1,523,298			
HSCNO	Data Center HVAC Replacement of Air Cooled Chiller	\$260,000	Operational Funds	Interim Exec. VP Torres	04/20/21
		\$260,000			
HSCS	Med/Peds and Genral Internal Renovations	\$387,225	Fees generated from physician collections	Interim Exec. VP Torres	11/17/20
		\$387,225			
LALLIE KEMP	Modular Clinic Building	\$490,000	Other Funds: Cares Act Funding	Interim Exec. VP Torres	03/23/21
		\$490,000			
PBRC	Renovations to Animal Metabolism & Behavioral Core Facility Comparative Biology Bldg. E	\$465,000	\$300,000 Federal Grant Funding/ \$165,000 Operational Funds	Interim Exec. VP Torres	05/07/21
		\$465,000			
TOTAL CAPITAL PROJECTS APPROVALS 2020-2021		\$7,800,424			

Report to LSU Board of Supervisors: Capital Improvements Projects above \$175,000
All Campuses Last 3 Years

Updated October 11, 2021

	2019-2020		AMOUNT APPROVED	FUNDS SOURCE	APPROVED BY	APPROVAL DATE	
LSU	Allen Hall 1st Floor Classroom Renovations		\$450,000	Operationsl Funds	Exec. VP Layzell	03/13/20	
	Chemical Engineering Restroom Renovations		\$250,000	Operational Funds	Exec. VP Layzell	01/14/20	
	East Campus Apartments Building #4 Roof Repairs		\$265,320	Auxiliary Funds	Exec. VP Layzell	09/06/19	
	FETI New Building for SCBA & Compressor		\$175,453	Operational Funds	Exec. VP Layzell	03/02/20	
	Firing Range Facility		\$292,000	Other Funds	Exec. VP Layzell	12/20/19	
	Food Science Building Tile Roof Repair		\$350,000	Self-Generated	Exec. VP Layzell	12/20/19	
	Football Operations Building: Video Tower		\$250,000	Auxiliary Funds	Exec. VP Layzell	05/18/20	
	Hill Memorial Library Renovation		\$290,000	Foundation Funds	Exec. VP Layzell	04/02/20	
	Jesse Coates: Biology Teaching Labs		\$480,000	Auxiliary Funds	Exec. VP Layzell	12/20/19	
	Residential College North Hall Painting		\$250,000	Auxiliary Funds	Exec. VP Layzell	03/13/20	
	Student Union Roof Replacements Area 2 & Area 3		\$340,122	Auxiliary Funds	Exec. VP Layzell	02/10/20	
	Student Union Tiger Card Office Renovation		\$225,000	Auxiliary Funds	Exec. VP Layzell	12/06/19	
	SVM: Large Animal Operating Room 1817C & 1817G Replace OR Lights		\$210,000	Operational Funds	Exec. VP Layzell	03/24/20	
	Williams Hall 3rd Floor Lab Renovations		\$282,582	Operational Funds	Exec. VP Layzell	11/18/19	
		Subtotal LSU		\$4,110,477			
	AgCenter	Burden Trees & Trails Restroom re-approval adding \$160,000		\$510,000	Donated funds	Board of Regents	01/10/19
			Subtotal AgCenter	\$510,000		Exec. VP Layzell	03/16/20
HSCNO	Alled Health/School of Nursing (AHSON) 7th & 8th Floor Restroom Renovatio		\$395,000	Operational Funds	Exec. VP Layzell	07/15/19	
	Dental School Orthodontics Conf. Rm. & Offices Renovation		\$300,000	Foundation Funds	Exec. VP Layzell	03/20/20	
	MEB 1st Floor Lobby Flooring Replacement		\$300,000	Self Generated	Exec. VP Layzell	03/20/20	
	Subtotal HSCNO		\$995,000				
LSUS	Asphalt Parking Lot Repair Overlay		\$446,674	Tuition & Fees	Exec. VP Layzell	01/06/20	
	Baseball Locker Room Facility		\$476,440	Auxiliary Revenues	Exec. VP Layzell	12/05/19	
	Business Education Building 1st Floor Corridor Improvements		\$408,000	Tuition/Fee Revenue	Exec. VP Layzell	12/05/19	
	Business Education Building Business Intelligence Lab		\$213,400	Tuition & Fees	Exec. VP Layzell	01/23/20	
	Business Education Building Curriculum Remodel		\$408,000	Online Tuition/Fee Revenue	Exec. VP Layzell	11/10/19	
	Business Education Building Student Advising Center Suite & Boardroom Renc		\$268,320	Tuition & Fees	Exec. VP Layzell	04/15/20	
	Health & Physical Education Building Locker Room Remodeling		\$455,900	Tuition & Fees	Exec. VP Layzell	01/23/20	
	Health & Physical Education Building Racket Ball Courts		\$396,300	Tuition & Fees	Exec. VP Layzell	01/23/20	
	Science Lecture Hall Renovation		\$425,000	Online Tuition/Fee Revenue	Exec. VP Layzell	12/05/19	
	Tennis Storage Restroom		\$220,451	Tuition & Fees	Exec. VP Layzell	06/01/20	
	Subtotal LSUS		\$3,718,485				
TOTAL CAPITAL PROJECTS APPROVALS 2019-2020			\$9,333,962				

Report to LSU Board of Supervisors: Capital Improvements Projects above \$175,000
All Campuses Last 3 Years

Updated October 11, 2021

	2018-2019		AMOUNT APPROVED	FUNDS SOURCE	APPROVED BY	APPROVAL DATE	
LSU	Foster Hall Renovations		\$470,000	Other Ancillary Self-Generated Revenues	Exec. VP Layzell	07/10/18	
	Hill Memorial Library Roof Replacement		\$490,000	Ancillary Self-Generated Revenues	Exec. VP Layzell	09/27/18	
	Louisiana Animal Disease Diagnostic Laboratory 2nd Floor Lab Addition		\$633,600	School of Vet. Med. Self-Generated Revenue	Exec. VP Layzell	09/20/18	
	Military Science Building Roof Replacement		\$860,000	Ancillary Self-Generated Revenues	Exec. VP Layzell	09/27/18	
	PERTT Facility Building Repairs-Roof Replacement		\$337,733	Operational Funds	Exec. VP Layzell	12/14/18	
	East Campus Apartments Building #9 Roof Repairs		\$265,320	Auxiliary Funds	Exec. VP Layzell	05/07/19	
	School of Veterinary Medicine Toilet Room Renovations (1204-1206, 1406-112)		\$301,962	Self-Generated Revenue	Exec. VP Layzell	05/07/19	
	PMAC AHU 9 Replacement-Volleyball		\$490,000	Auxiliary Funds	Exec. VP Layzell	05/03/19	
	Pleasant Hall Renovation		\$490,000	Operational Funds	Exec. VP Layzell	10/25/18	
	Pleasant Hall Renovation Budget Increase		\$118,000	Additional Operational Funds	Board of Regents	03/04/19	
	Student Health Center Subsurface Drainage Installation		\$360,000	Auxiliary Funds	Exec. VP Layzell	09/20/18	
		Subtotal LSU		\$4,816,615			
	AgCenter	Burden Museum & Gardens New Entrance Road		\$450,000	1/3 Burden Foundation, 1/3 AgCenter, 1/3 LSU	Exec. VP Layzell	01/10/19
		Subtotal AgCenter	\$450,000		Exec. VP Layzell		
HSCNO	MEB 3rd Floor Audio-Visual Training Center		\$350,000	Self-Generated Revenues	Exec. VP Layzell	03/27/19	
	Clinical Sciences and Research Building (CSRB) Lab Renovation 4th Floor		\$450,000	Indirect Fee Grant	Exec. VP Layzell	06/24/19	
	Clinical Sciences and Research Building (CSRB) Purchase of Replacement AHU		\$395,000	Self-Generated Revenues	Exec. VP Layzell	06/24/19	
		Subtotal HSCNO	\$350,000				
LSUE	Acadian Hall Kitchen Renovation		\$456,986	Auxiliary Revenues	Exec. VP Layzell	03/11/19	
		Subtotal LSUE	\$456,986				
LSUS	Business Education Building 3rd Floor Renovation		\$237,450	Self-Generated (Fees & Tuition)	Exec. VP Layzell	03/27/19	
	Cyber Collaboratory		\$450,000	Self-Generated (Fees & Tuition)	Exec. VP Layzell	08/21/18	
	New Soccer Building		\$449,500	Self-Generated (Fees & Tuition)	Exec. VP Layzell	04/03/19	
	Student Veteran Resource Center		\$200,000	Self-Generated (Fees & Tuition)	Exec. VP Layzell	07/31/18	
		Subtotal LSUS	\$1,336,950				
TOTAL CAPITAL PROJECTS APPROVALS 2018-2019			\$7,410,551				

**Report to LSU Board of Supervisors:
All Campuses Last 3 Years**

Design Contracts

Updated October 11, 2021

	2021-2022 Design Contracts		Designer Fee	Reimbursables or other fees	Revised Total	Designer	Approved by	Approval Date
LSU A&M	Life Sciences Annex East & North Facade Waterproofing		\$45,914	\$1,500	\$47,414	Didier Architecture	AVP Mahaffey	08/13/21
	French House Honors College Site & Landscaping Improvements Phase 1a		\$37,800	\$18,315	\$56,115	CARBO Landscape Architecture	AVP Mahaffey	08/27/21
	John P. Laborde Energy Law Center Renovations		\$34,409	\$1,500	\$35,909	Tipton Associates APAC	AVP Mahaffey	08/13/21
	Subtotal		\$118,124	\$21,315	\$139,439			
LSU A&M	Frey UPS1 Replacement and System Upgrades		\$131,442	\$0	\$131,442	Assaf Simoneaux Tauzin & Associates (AST)	Engineer Selection Bd.	07/14/21
	Subtotal		\$131,442	\$0	\$131,442			
	Total LSU A&M		\$249,566	\$21,315	\$270,881			
HSCNO	Medical Education Bldg. Laboratory Renovations		\$926,559	\$0	\$926,559	Gould Evans + Perkins Eastman, AJV	Engineer Selections Bd.	09/15/21
	Total HSCNO		\$926,559	\$0	\$926,559			
HSCS	Stonewall Facility Renovations & Additions		\$78,714	\$0	\$78,714	Prevot Design Services, APAC	Architect Selection Bd.	07/21/21
	Total HSCS		\$78,714	\$0	\$78,714			
LSUS	Swimming Pool Closure		\$33,013		\$33,013	Edmonds Engineering Services	AVP Mahaffey	08/25/21
	Physical Plant Office Bldg. Reroof		\$10,310		\$10,310	Sutton Beebe Babin Architects, LLC	AVP Mahaffey	09/24/21
	Subtotal		\$43,323	\$0	\$43,323			
LSUS	Bldg. Exterior Walls, Technology Center & Science Bldg.		\$117,901	\$0	\$117,901	Sutton Beebe Babin Architects, LLC	Architect Selection Bd.	09/15/21
	Subtotal		\$117,901	\$0	\$117,901			
	Total LSUS		\$161,224	\$0	\$150,914			
	TOTAL ALL CAMPUSES 2020-2021		\$1,416,063	\$21,315	\$1,427,068			

**Report to LSU Board of Supervisors:
All Campuses Last 3 Years**

Design Contracts

Updated October 11, 2021

	2020-2021 Design Contracts		Designer Fee	Reimbursables or other fees	Revised Total	Designer	Approved by	Approval Date
LSU A&M	Chemistry & Materials Bldg. Room 122 Renovations		\$31,130	\$1,000	\$32,130	Bradley Blewster & Associates	AVP Mahaffey	09/08/20
	Bldg. Demolition Group 1 Abatement Design Services		\$11,747	\$20,241	\$31,988	Wynn L. White Consulting Engineers	AVP Mahaffey	05/07/21
	Bldg. Demolition Group 2 Abatement Design Services		\$14,050	\$17,320	\$31,370	Rayner Consulting Group LLC	AVP Mahaffey	05/07/21
	Jesse Coates Biology Teaching Labs Renovation-3rd Floor		\$44,524	\$5,000	\$49,524	Greenleaf Lawson Architects	AVP Mahaffey	12/01/20
	Military Science Bldg.-Pre-Programming Study		\$17,250		\$17,250	Facility Programming LTD	AVP Mahaffey	04/07/21
	PERTT Phase 2 Electrical Improvements		\$28,591		\$28,591	Nesbit and Associates LLC	AVP Mahaffey	11/20/20
	SVM Condenser Water Line Replacement		\$25,782		\$25,782	Assaf Simoneaux Tauzin & Associates (AST)	AVP Mahaffey	01/19/21
	SVM DLAM Expansion Planning Study		\$45,000	\$1,200	\$46,200	Washer Hill Lipscomb Cabaniss Architecture LA LLC-WHLC Architecture	AVP Mahaffey	12/11/20
	SVM Main Bldg. Junior Surgery Renovation Program Planning Study		\$16,500		\$16,500	Tipton Associates APAC	AVP Mahaffey	03/05/21
	Subtotal		\$234,573	\$43,761	\$279,335			
LSU A&M	Renewable Natural Resources Repairs to HVAC, Ductwork & Roof		\$302,704		\$302,704	Assa Simoneaux Tauzin & Associates (AST)	Engineer Selection Bd.	10/14/20
	SVM Accreditation Repairs		\$192,294		\$192,294	Owen & White Inc.	Engineer Selection Bd.	10/14/20
	Subtotal		\$192,294	\$0	\$192,294			
	Total LSU A&M		\$426,867	\$43,761	\$471,629			
AgCenter	Tornado Damage Reconstruction, Dean Lee Research Ctr.		\$409,069	\$0	\$409,069	Alliance Design Group, LLC	Architect Selection Bd.	05/19/21
	Total		\$409,069	\$0	\$409,069			
HSCNO	MEB 3rd Floor Restrooms Renovation		\$13,600	1.10 x actual	Fee + Reimbursables	Mathes Brierre Architects	AVP Mahaffey	09/16/20
	Dental School Hurrican Zeta Damage		\$19,781		\$19,781	Duplantier & Meric Architects, LLC	AVP Mahaffey	04/15/21
	Central Plant Water Softener Pipe Distribution		\$30,000		\$30,000	Huseman & Associates	AVP Mahaffey	05/18/21
	Total		\$63,381		\$63,381			
HSCS	6th Floor Department of Medicine Renovations-Phase I		\$48,420	1.15 x Actual	Fee + Reimbursables	Prevot Design	AVP Mahaffey	09/18/19
	Total		\$48,420		\$48,420			
LSUS	Administration Bldg. Foundation Lobby & Chancellors Suite		\$15,800	\$0	\$15,800	Sutton Beebe Babin Architects	AVP Mahaffey	02/08/21
	Business & Education Bldg. Convert Classrooms to Office 2nd Floor		\$12,294	\$0	\$12,294	Sutton Beebe Babin Architects	AVP Mahaffey	02/05/21
	Technology Center Collaboratory Technology Equipment Room		\$16,995	\$0	\$16,995	Sutton Beebe Babin Architects	AVP Mahaffey	11/9/2020
	Noel Library Student Development Suite		\$38,022	\$0	\$38,022	Sutton Beebe Babin Architects	AVP Mahaffey	02/02/21
	Technology Center Bldg. Replacement of End of Life Air Handling Units		\$23,650	\$0	\$23,650	Purtle & Associates, LLC	AVP Mahaffey	01/14/21
	University Center Diversity & Inclusion office		\$16,365	\$0	\$16,365	Sutton Beebe Babin Architects	AVP Mahaffey	02/08/21
	Subtotal		\$123,126	\$0	\$123,126			
LSUS	Vehicular & Pedestrian Bridge to Pilots Point Apartments		\$102,522	\$0	\$102,522	Cothren, Graff, Smoak, Engineering	Engineer Selection Bd.	04/14/21
	Subtotal		\$102,522	\$0	\$102,522			
	Total LSUS		\$225,648	\$0	\$225,648			
	TOTAL ALL CAMPUSES 2020-2021		\$764,316	\$43,761	\$976,611			

**Report to LSU Board of Supervisors:
All Campuses Last 3 Years**

Design Contracts

Updated October 11, 2021

	2019-2020 Design Contracts		Designer Fee	Reimbursables or other fees	Revised Total	Designer	Approved by	Approval Date
LSU A&M	Chemical Engineering Restrooms Renovation		\$29,583	\$5,000	\$34,583	Greenleaf Lawson Architects	AVP Danny Mahaffey	01/13/20
	Honors College Site Plan Schematic Design		\$44,000	\$5,000	\$49,000	Tipton Associates	AVP Danny Mahaffey	08/28/19
	Jesse Coates Biology Teaching Labs		\$53,593	\$5,000	\$58,593	Greenleaf Lawson Architects	AVP Danny Mahaffey	01/13/20
	Student Union Roof Replacements		\$23,492	\$1,780	\$25,272	Neal Johnson, LLC	AVP Danny Mahaffey	05/11/20
	Williams Hall 3rd Floor Lab Renovation		\$31,681	\$500	\$32,181	Mougeot Architecture	AVP Danny Mahaffey	09/12/19
		Subtotal	\$182,349	\$17,280	\$199,629			
LSU A&M	Innovation Park Roadway Improvements Project		\$1,664,371	\$0	\$1,664,371	Professional Engineering Consultants Corp.	Architect Selection Bd.	09/17/19
	New Science Bldg.		\$669,072		\$669,072	Eskew Dumez Ripple APAC	Architect Selection Bd.	01/15/20
	Utility Infrastructure Improvements-Sciences Zone		\$136,094		\$136,094	Infinity Engineering Consultants	Engineer Selection Bd.	04/08/20
	Howe Russell: Replace Two AHU's		\$83,613		\$83,613	Henry C. Eyre Consulting Engineers	Architect Selection Bd.	01/29/20
		Subtotal	\$2,553,150	\$0	\$2,553,150			
	Total LSU A&M		\$2,735,499	\$17,280	\$2,752,779			
AgCenter	LSU Burden Botanic Gardens Drainage		\$28,477		\$28,477	Bonton Associates	AVP Danny Mahaffey	01/14/20
	NFS Programming-Food Science		\$30,000		\$30,000	Bonton Associates	AVP Danny Mahaffey	01/14/20
	Total AgCenter		\$58,477		\$58,477			
HSCNO	AHSON 7th & 8th Floor Restroom Renovation		\$16,600	1.10 x actual	Fee + Reimbursables	Mathes Brierre Architects	AVP Mahaffey	07/10/19
	Dental School Orthodontics Conference Room & Office Renovation		\$11,980	1.10 x actual	Fee + Reimbursables	Mathes Brierre Architects	AVP Mahaffey	03/23/20
		Subtotal	\$16,600		\$0			
HSCNO	Replacement of How Water Supply & Return Lines		\$66,477		\$66,477	M & E Consulting, Inc.	Engineer Selection Bd.	01/08/20
		Subtotal	\$66,477		\$66,477			
	Total HSCNO		\$83,077	\$0	\$66,477			
HSCS	Center for Medical Education and Wellness		\$1,862,920	\$0	\$1,862,920	Coleman Partners Architects/Perkins and Will Inc. AJV	Architect Selection Bd.	09/10/19
	Total HSCS		\$1,862,920	\$0	\$1,862,920			
LSUS	Baseball Locker Room Facility		\$46,800	\$3,200	\$50,000	Sutton Beebe Babin Architects	AVP Mahaffey	12/03/19
	Bike Path & Running Path Preliminary Design		\$14,700		\$14,700	Sutton Beebe Babin Architects	AVP Mahaffey	08/26/19
	Bronson Hall Renovation to Rooms 252 & 242		\$20,815		\$20,815	Sutton Beebe Babin Architects	AVP Mahaffey	12/19/19
	Business Education Bldg. Curriculum Resource Center Remodel		\$39,780		\$39,780	Sutton Beebe Babin Architects	AVP Mahaffey	11/04/19
	Business Intelligence Lab		\$24,670		\$24,670	Sutton Beebe Babin Architects	AVP Mahaffey	01/14/20
	Health & PE Bldg. Convert Racket Ball Courts to Exercise Physiology		\$39,557		\$39,557	Sutton Beebe Babin Architects	AVP Mahaffey	01/14/20
	Health & PE Bldg. Locker Room Remodeling		\$53,516		\$53,516	Sutton Beebe Babin Architects	AVP Mahaffey	01/14/20
	Noel Memorial Library Waterproofing		\$15,812	\$0	\$15,812	Sutton Beebe Babin Architects	AVP Mahaffey	
	Science Lecture Hall Renovation		\$45,959		\$45,959	Prevot Design	AVP Mahaffey	11/21/19
	Total LSUS		\$301,609	\$3,200	\$304,809			
PBRC	Reroof Comparative Biology, Utilities & Central Store		\$64,608		\$64,608	Post Architects, LLS	Architect Selection Bd.	09/10/19
	Total LSUS		\$64,608	\$0	\$64,608			
	TOTAL ALL CAMPUSES 2019-2020		\$5,047,713	\$20,480	\$5,051,593			

**Report to LSU Board of Supervisors:
All Campuses Last 3 Years**

Design Contracts

Updated October 11, 2021

	2018-2019 Design Contracts		Designer Fee	Reimbursables or other fees	Revised Total	Designer	Approved by	Approval Date
LSU A&M	Choppin Hall 7th Floor Lab Renovation		\$14,707	\$500	\$15,207	Mougeot Architecture	AVP Danny Mahaffey	06/17/19
	Design Bldg. Skylight Replacement		\$78,798	\$4,700	\$83,498	Post Architects	AVP Danny Mahaffey	07/12/18
	Hatcher Hall Exterior Skin Upgrades		\$42,104	\$1,500	\$43,604	GD Architecture	AVP Danny Mahaffey	03/18/19
	Lab School Entry Project		\$24,547	\$2,500	\$27,047	Tipton Assoc.	AVP Danny Mahaffey	12/13/18
	Nicholson Hall Roof Replacement		\$41,595		\$41,595	Jerry M. Campbell & Associates	AVP Danny Mahaffey	04/30/19
	PMAC Volleyball HVAC Replacement		\$33,916	\$9,306	\$43,222	Henry C. Eyre, Jr. PE, Inc.	AVP Danny Mahaffey	04/16/19
	Roosevelt Apartments Abatement & Demolition		\$10,412	\$14,773	\$25,185	Wynn White Consulting Engineers	AVP Danny Mahaffey	05/28/19
	Student Health Moisture Issues		\$39,691	\$9,300	\$48,991	Wynn White Consulting Engineers	AVP Danny Mahaffey	09/19/18
	Student Union Tiger Card Office Renovation		\$22,706	\$2,000	\$24,706	GraceHebert Architects	AVP Danny Mahaffey	02/12/19
	University Stores Renovations for Parking & Transportation		\$41,595	\$500	\$42,095	Jerry M. Campbell & Associates	AVP Danny Mahaffey	05/28/19
	Vet School Master Plan Proposal		\$40,000	Actual Cost	\$40,000	Tipton Assoc.	AVP Danny Mahaffey	09/19/18
	Vet School Toilet Room Renovation at 2 1st Floor Student Locker Rooms		\$34,026	\$1,000	\$35,026	Bradley-Blewster Assoc.	AVP Danny Mahaffey	01/23/19
		Subtotal		\$424,098	\$46,079	\$470,177		
LSU A&M	HP Long Field House Renovations		\$1,664,371		\$1,664,371	Remson Haley Herpin Architects/ Tipton Assoc.	Architect Selection Bd.	11/27/18
	La. Animal Disease Diagnostic Laboratory (LADDL) 2nd Floor Lab Addition		\$40,495		\$40,495	GD Architecture	Architect Selection Bd.	11/27/18
	Subtotal		\$1,704,866	\$0	\$1,704,866			
	Total LSU A&M		\$2,128,964	\$46,079	\$2,175,043			
AgCenter	Efferson Hall Conference Room Renovation		\$10,438	\$500	\$10,938	Domain Architecture	AVP Mahaffey	07/12/18
	Total AgCenter		\$10,438	\$500	\$10,938			
HSCNO	CSRB 4th Floor Renovations		\$25,550	1.10 x actual	\$25,550	Mathes Brierre Architects	AVP Mahaffey	06/24/19
	Total HSCNO		\$25,550		\$25,550			
HSCS	Medical School B-Bldg. HVAC Replacement		\$284,231		\$284,231	John J. Guth Assoc.	Engineer Selection Bd.	11/27/18
	Total HSCS		\$284,231	\$0	\$284,231			
LSUS	Technology Center Cyber Collaboratory Project		\$42,671	\$4,500	\$47,171	Sutton Beebe Babin Architects	AVP Mahaffey	09/21/18
	Veterans Resource Center		\$20,397	\$0	\$20,397	Sutton Beebe Babin Architects	AVP Mahaffey	08/02/18
	Total LSUS		\$63,068	\$4,500	\$67,568			
	TOTAL ALL CAMPUSES 2018-2019		\$2,486,701	\$51,079	\$2,537,780			

**Report to LSU Board of Supervisors:
All Campuses Last 3 Years**

Foundation Construction Related Agreements*

Updated October 11, 2021

**Donation to follow upon completion and acceptance of all work or as stated in the agreement*

2021-2022					Estimated	Approval	
Document Type	Campus	Lessor	Lessee	Project	Cost	Date	Approved by
License for Use Agreement	PBRC	LSU BoS	Tiger Athletic Foundation	Tiger Stadium North Structural Repairs 2021	\$100,000	11/16/2020	Int. Exec VP Torres
License for Use Agreement	LSU	LSU BoS	Tiger Athletic Foundation	PMAC Retractable Bleacher Repairs	\$100,000	11/16/2020	Int. Exec VP Torres
2020-2021					Estimated	Approval	
Document Type	Campus	Lessor	Lessee	Project	Cost	Date	Approved by
License for Use Agreement	PBRC	LSU BoS	Pennington Biomedical Research Foundation	Center for Excellence in Bariatric/Metabolic Surgery and Research	\$3,500,000	3/9/2020	Interim Pres. Galligan
License for Use Agreement	LSU	LSU BoS	Tiger Athletic Foundation	PMAC Retractable Bleacher Repairs	\$100,000	11/16/2020	Int. Exec VP
2019-2020					Estimated	Approval	
Document Type	Campus	Lessor	Lessee	Project	Cost	Date	Approved by
License for Use Agreement	LSU	LSU BoS	Tiger Athletic Foundation	Alex Box Practice Facility Pitching Center	\$130,000	8/23/2019	Exec. VP Layzell
License for Use Agreement	LSU	LSU BoS	Tiger Athletic Foundation	Renovation	\$750,000	4/3/2020	Exec. VP Layzell
License for Use Agreement	LSU	LSU BoS	Tiger Athletic Foundation	Tiger Stadium North Players Chute	\$130,000	5/20/2020	Exec. VP Layzell
License for Use Agreement	LSU	LSU BoS	Tiger Athletic Foundation	Tiger Stadium Lawton Room Updates	\$450,000	5/20/2020	Exec. VP Layzell
License for Use Agreement	LSU	LSU BoS	Tiger Athletic Foundation	Indoor Practice Facility Air Handler Upgrades	\$525,000	5/20/2020	Exec. VP Layzell
License for Use Agreement	LSU	LSU BoS	Tiger Athletic Foundation	Tiger Stadium Monuments	\$80,000	5/27/2020	Exec. VP Layzell
License for Use Agreement	LSU	LSU BoS	Tiger Athletic Foundation	Alex Box Team Room	\$350,000	5/27/2020	Exec. VP Layzell
License for Use Agreement	LSU	LSU BoS	Tiger Athletic Foundation	Tiger Stadium East & West Bowl Structural Repairs	\$175,000	5/20/2020	Exec. VP Layzell
License for Use Agreement	LSU	LSU BoS	Tiger Athletic Foundation	PMAC Floor Expansion & Refinishing	\$150,000	5/20/2020	Exec. VP Layzell
Lease Agreement	LSU	LSU BoS	Tiger Athletic Foundation	Charles McClendon Outdoor Practice Facility Replacement of Synthetic Turf	\$1,700,000	1/22/2020	Int. Pres. Galligan
License for Use Agreement	LSU	LSU BoS	Tiger Athletic Foundation	Tiger Stadium- North End Zone Joint Repairs Ph. 11	\$550,000	12/31/2019	Exec. VP Layzell
License for Use Agreement	LSU	LSU BoS	Tiger Athletic Foundation	Gymnastics Practice Facility Vault Lift Installation	\$175,000	8/8/2019	Exec. VP Layzell
License for Use Agreement	LSU	LSU BoS	Tiger Athletic Foundation	Pete Maravich Statue Installation & Plaza	\$250,000	8/8/2019	Exec. VP Layzell
License for Use Agreement	LSU	LSU BoS	Tiger Athletic Foundation	PMAC Replacement & Installation of Indoor Lighting Equipment	\$80,000	8/8/2019	Exec. VP Layzell

**Report to LSU Board of Supervisors:
All Campuses Last 3 Years**

Foundation Construction Related Agreements*

Updated October 11, 2021

**Donation to follow upon completion and acceptance of all work or as stated in the agreement*

Document Type	2018-2019			Project	Estimated Cost	Approval Date	Approved by
	Campus	Lessor	Lessee				
License for Use Agreement	LSU	LSU BoS	Recital Hall LLC (REFF)	New Music Building Recital Hall Renovation	\$3,500,000	9/20/2018	Exec. VP Layzell
Lease Agreement	LSU	LSU BoS	Tiger Athletic Foundation	Alex Box Champions Plaza	\$1,000,000	12/17/2018	Pres. Alexander
License for Use Agreement	LSU	LSU BoS	Tiger Athletic Foundation	Beach Volleyball Waterproofing Repairs	\$350,000	7/31/2018	Exec. VP Layzell
License for Use Agreement	LSU	LSU BoS	Tiger Athletic Foundation	Dr. Billy Cannon Statue Installation and Plaza	\$250,000	7/23/2018	Exec. VP Layzell
License for Use Agreement	LSU	LSU BoS	Tiger Athletic Foundation	Golf Practice Facility Hitting Bay Improvements	\$40,000	4/26/2019	Exec. VP Layzell
License for Use Agreement	LSU	LSU BoS	Tiger Athletic Foundation	Tennis Complex Resurfacing of Courts	\$180,000	6/10/2019	Exec. VP Layzell
License for Use Agreement	LSU	LSU BoS	Tiger Athletic Foundation	Tiger Stadium North End Zone Joint Repairs Ph. I	\$350,000	7/23/2018	Exec. VP Layzell
Lease Agreement	LSU	LSU BoS	Tiger Athletic Foundation	Tiger Stadium S. Plaza Victory Recognition	\$1,600,000	12/10/2018	Pres. Alexander
License for Use Agreement	LSU	LSU BoS	SLA LLC (REFF)	School of Landscape Architecture Renovations	\$574,810	9/12/2018	Exec. VP Layzell

**Report to LSU Board of Supervisors:
All Campuses Last 3 Years**

Grants of Mineral Rights

Updated October 11, 2021

2021-2022															
Campus that Benefits	Sale Date	State Lease #	Leased to:	Operated by	Release Date	Parish	Section, Township, Range	Acres Bid	Lease Term	Cash Bonus	Price Per Acre	Rentals/Year	Royalty	Accepted Acres	Accepted Bonus
n/a															
2020-2021															
Campus that Benefits	Sale Date	State Lease #	Leased to:	Operated by	Release Date	Parish	Section, Township, Range	Acres Bid	Lease Term	Cash Bonus	Price Per Acre	Rentals/Year	Royalty	Accepted Acres	Accepted Bonus
n/a															
2019-2020															
Campus that Benefits	Sale Date	State Lease #	Leased to:	Operated by	Release Date	Parish	Section, Township, Range	Acres Bid	Lease Term	Cash Bonus	Price Per Acre	Rentals/Year	Royalty	Accepted Acres	Accepted Bonus
AgCenter	07/10/19	21927	Mack Energy Co.			East Baton Rouge	S65-66-67-68-69-70, T8S, R1W	674.780	3 years	\$84,347.50	\$250.00	\$84,347.50	22.5%	674.780	\$84,347.50
2018-2019															
Campus that Benefits	Sale Date	State Lease #	Leased to:	Operated by	Release Date	Parish	Section, Township, Range	Acres Bid	Lease Term	Cash Bonus	Price Per Acre	Rentals/Year	Royalty	Accepted Acres	Accepted Bonus
n/a															

**Report to LSU Board of Supervisors:
All Campuses**

Other Agreements and Approval Requests

Updated October 11, 2021

2021-2022				
Document Type	Campus	Lessor or Seller or Assignor	Lessee or Buyer or Assignee	Related Agreements or Purpose
Cooperative Endeavor Agreement for local funding of Phase 1 of Lakes Improvements	LSU Board of Supervisors, East Baton Rouge Parish, BREC and University Lakes, LLC			CEA Implement Grant under the Community Development Block Grant providing local funding
Option Term 5	AgCenter	Corpus Christ Church-Epiphany Catholic Church	AgCenter Extension Center Space	Change end date to 6/22/2022
Revision to Prior Authorization to enter into CEA & Lease with La. Dept. of Agriculture & Forestry	AgCenter	LSU BoS	Louisiana Dept. of Agriculture and Forestry	Joint Operation and Maintenance of AgChemistry Building
Option Term 1	AgCenter	Northeast Educational Development Foundation	AgCenter Rural Development Center	Changes end date to 6/30/2022
Option Term 3	AgCenter	Town of Vidalia	AgCenter Concordia Extension Service	Changes end date to 6/30/2022
Estoppel Certificate for LSU Real Estate and Facilities Foundation & Charity Hospital Redevelopment LLC of Charity Hospital	HCSO	LSU Board of Supervisors & Real Estate & Facilities Foundation	In Favor of 1532 Tulane Partners Holdco, LLC	Estoppel Agreement
Amendment 1 to Inter-Agency Lease	HSCNO	HSCNO	Office of State Police	Office Space in exchange for security services
Cooperative Endeavor Agreement	HSCNO	LSU Board of Supervisors	LSU Health Foundation, New Orleans	Adaptive Reuse of Stanislaus Hall for nursing home services to residents and nursing home education to students & faculty of HSCNO
Amendment #1 to Lease agreement	HSCS	CLM Properties	HSCS	Medical Resident housing
2020-2021				
Document Type	Campus	Lessor or Seller or Assignor	Lessee or Buyer or Assignee	Related Agreements or Purpose
Fire Marshall Covenant for LSU Old President's Hosue	LSU A&M	LSU BoS	La. State Fire Marshal	Give a legal covenant to the La. State Fire Marshal to bind and encumber maximum occupancy of Old Pres. House Rm. 1004 to maximum occupancy of 49 persons
2nd Amendment to Ground Lease	LSU A&M	LSU BoS	LSU Foundation	Amend to reduce leased land area to the footprint of the building
1st Amendment to CEA for lease of land for construction & operation of La. Emerging Technology Center Building	LSU A&M	LSU BoS	LSU Research Foundation	Amend CEA to include revised land area.
Consent to Assignment & Termination of Lease	LSU A&M	Alpha Gamma House Corp of Pi Kappa Alpha Corporation	Epsilon Zeta Housing Corporation	Assignment or sale of existing leasehold interest
Consent to Leasehold Mortgage	LSU A&M	LSU BoS	House of Southern Woods Corporation	Needed to provide information to lender regarding mortgage loan with CHI
Option Term 4	AgCenter	Corpus Christ Church-Epiphany Catholic Church	AgCenter Extension Center Space	Change end date to 6/22/2021
Option Term 2	AgCenter	Town of Vidalia	AgCenter Concordia Extension Service	Changes end date to 6/30/2021
Purchase of Property at 2127 Poydras St., New Orleans	HSCNO	Daniel Jackson	LSU Health Foundation New Orleans	Future donation to LSU Health New Orleans
Addendum to Lease Agreement between La. Cancer Research Center (LCRC) & LSU Health Science Center New Orleans (HSCNO)	HSCNO	LCRC	HSCNO	HSCNO agrees to manage & finance repairs to equipment in HSCNO's leased area of LCRC Building
Acknowledgement regarding Transaction & Approval of Qualified Assignee	HSCNO	LSU BoS	Brookfield District Energy USA, LLC d/b/a/ Enwave USA	Acknowledgment Regarding Transaction and Approval of Qualified Assignee

	2019-2020			
Document Type	Campus	Lessor or Seller or Assignor	Lessee or Buyer or Assignee	Related Agreements or Purpose
Approval of Nicholson Gateway Retail Lease	LSU A&M	Nicholson Gateway Project, LLC	Torchy's Tacos	Lease of Retail Space
Approval of Nicholson Gateway Retail Lease	LSU A&M	Nicholson Gateway Project, LLC	AT&T	Lease of Retail Space
Approval of Nicholson Gateway Retail Lease	LSU A&M	Nicholson Gateway Project, LLC	Fat Boys Pizza	Lease of Retail Space
1st Amendment to Ground Lease	LSU A&M	LSU	Baton Rouge Speech & Hearing Foundation	Foundation to exercise option term and amend lease & add additional property
Cooperative Endeavor Agreement	LSU A&M	LSU	LSU Research Foundation	Amended & Restated CEA for the La. Emerging Technologies Center and the La. Digital Media Facility to include obligations related to LSU's Innovation Park
Cooperative Endeavor Agreement	LSU A&M	LSU, BREC, City of Baton Rouge & Parish of East Baton Rouge, and		CEA for Lakes Project Advisor
MOU Master Plan of the Lakes	LSU A&M	LSU, State of La., City & Parish of EBR, BREC, BRAF & REFF		Memorandum of Understanding for the University Lakes Project
Amendment 2 & Option Term 3	AgCenter	Corpus Christi-Epiphany Catholic Church	AgCenter Extension Center Space	Change end date to 6/22/2020
Option Term 5	AgCenter	Northeast Educational Development Foundation	AgCenter Rural Development Center	Changes end date to 6/30/2020
Amendment 1	AgCenter	Northeast Educational Development Foundation	AgCenter Rural Development Center	Changes square foot rate from \$6.00 to \$7.50
1st Amendment to Ground Lease	AgCenter	AgCenter	Iris Solar	Adjusts area to revise acreage due to being wetlands and adjusts rental
Option Term 7	HSCS	Willis-Knighton Medical Center	HSCS Depart. Of Psychiatry Outpatient Adolescent Clinic	Adjusts end date to 9/30/2020
MOU for the LED FastStart Division and Program	LSUS	LED	LSU, UL, SU, & LCTC Systems	Memorandum of Understanding

**Report to LSU Board of Supervisors:
All Campuses**

Other Agreements and Approval Requests

Updated October 11, 2021

	2018-2019			
Document Type	Campus	Lessor or Seller or Assignor	Lessee or Buyer or Assignee	Related Agreements or Purpose
Approval of Nicholson Gateway Retail Lease	LSU A&M	Nicholson Gateway Project, LLC	Simple Greek	Lease of Retail Space
Approval of Nicholson Gateway Retail Lease	LSU A&M	Nicholson Gateway Project, LLC	Private Stock	Lease of Retail Space
Approval of Nicholson Gateway Retail Lease	LSU A&M	Nicholson Gateway Project, LLC	General Health System (Baton Rouge General)	Lease of Retail Space
Amendment 1	LSU A&M	LSU	Electronic Arts	Extends term through 12/31/2023
Option Term 1	AgCenter	Town of Vidalia	AgCenter Concordia Extension Service	Changes end date to 6/30/2020
Assignment, Assumption & 3rd Amendment to Lease	AgCenter	LSU BoS	Christian Life Fellowship School & Church of the King, Baton Rouge, Inc.	Agreements for 5.3246 acres adjacent to the Perkins Road farm.
Assignment, Bill of Sale and Conveyance	AgCenter	Camterra Resources Partners Ltd.	Elm Grove Holdings, LLC	
Concurrence to renewal of Long Term Lease with USDA for Honey Bee Research	AgCenter	LSU Agricultural Center	United State Government	Consent to the USDA exercising its option term to renew its existing 50 year Long Term Lease for a renewal term of 50 years beginning 7/1/2018.
Option Term 4	AgCenter	Northeast Educational Development Foundation	AgCenter Rural Development Center	Changes end date to 6/30/2019
Consent to Sublease between LSU BoS for HCSD & Our Lady of Angels Hospital in Bogalusa	HCSD	LSU BoS	Our Lady of Angels Hospital	Agreement to sublease a portion of the property of a substance abuse provider
Determination of an Acceptable University Purpose for Donation of 3 parcels of property in Mandeville	HSCNO	The Al Copeland Family Foundation	LSU Health Foundation New Orleans	A single owner would like to donate 3 parcels in Mandeville near the north end of the causeway bridge. Two parcels total 21.43 acres. The third parcel is 7.6 acres and contains a marina.
Option Term 3	HCSD	The Foundation for the LSU Health Sciences Center	HCSD Accountable Care Office	Changes end date to 4/30/2022
Addendum to Lease	HSCNO	La. Cancer Research Center of LSU HSCNO & Tulane	HSCNO	Agreement between parties that LSU manage & finance repair of specialized equipment and be reimbursed by LCRC for repair costs
Amendments 2 & 3	HSCNO	HSCNO	LSU Healthcare Network	Lease to remain in force for 30 years; removes right of HSCNO to
Amendment 1	HSCNO	HSCNO	Pharmacy	Change total construction cost
1st Amendment to Lease for Parking Spaces	HSCNO	HSCNO	University Medical Center Management Corporation	Changes rental for 1st & last month and adds ability to charge fees to UMCMC for issuance of Gate tags & ID cards as necessary
Purchase Agreement for Property in Square 518 First District New Orleans	HSCNO	LSU BoS	Michael J. Clark	Purchase Agreement for 508-510 S. Galvez in New Orleans
Determination of an Acceptable University Purpose for purchase by LSU Health Foundation New Orleans of building in LaPlace	HSCNO	River Parishes Hospital	LSU Health Foundation New Orleans	Consent to purchase of adjacent facility to support ambulatory clinics
Option Term 6	HSCS	Willis-Knighton Medical Center	HSCS Depart. Of Psychiatry Outpatient Adolescent Clinic	Adjusts end date to 9/30/2019
Transfer of LSUE Manual Hall Annex Modular Building to LSUA for use by its soccer team.	LSU Eunice	LSU Eunice	LSU Alexandria	Approval to transfer between two LSU campuses in progress. LSU Eunice was no longer utilizing the building and did not need it. LSU Alexandria desires the building for use by the soccer team.
Second Amendment and Restated Ground Lease Agreement	LSU Eunice	LSU BoS	Bengal Village, LLC	
Memorandum of Lease- Second Amended and Restated Ground Lease	LSU Eunice	LSU BoS	Bengal Village, LLC	
Facilities Lease	LSU Eunice	LSU BoS	Bengal Village, LLC	
Memorandum of Lease- Facilities Lease	LSU Eunice	LSU BoS	Bengal Village, LLC	Lease Agreements and related documents needed to transfer LSUE on-campus student housing from Eunice Student Housing Foundation the Bengal Village, LLC, the sole member of which is the LSU Real Estate and Facilities Foundation.
Assignment and Assumption of Lease	LSU Eunice	Eunice Student Housing Foundation, Inc.	Bengal Village, LLC	
Act of Sale with Assumption of Mortgage	LSU Eunice	Eunice Student Housing Foundation, Inc.	Bengal Village, LLC	

Report to LSU Board of Supervisors: Property Leases

Updated October 11, 2021

All Campuses Last 3 Years

2021-2022													
Campus	Lessor or Sublessor	Lessee or Sublessee	Location	Lease Purpose	BoS Appr.	Start	Lease Term	Sq. Ft.	Annual Rental	Dollars / SF	Terms left	Length	Approved by
LSU A&M	WC Dock, LLC	LSU	Road, Ste. 100, Baton Rouge	For use as Office of Research & Economic Development		02/01/21	01/31/26	6,689	\$106,992.00	\$16.00	1	5-year	Interim Pres. Galligan
AgCenter	AgCenter	Our Veterans Memorial Park Inc.	Lee Memorial Forest	Veterans Memorial Wall	09/13/19	06/30/21	06/29/61	3 acres	n/a				Interim Pres. Galligan
HSCNO	HSCNO	CurVir Biotechnology & NeuResto Therapeutics	Lions Eye Center, New Orleans	Lease Agreement	n/a	07/01/21	06/30/21	229	\$4,122.00		4	1-year	Interim Pres. Galligan
2020-2021													
Campus	Lessor or Sublessor	Lessee or Sublessee	Location	Lease Purpose	BoS Appr.	Start	Lease Term	Sq. Ft.	Annual Rental	Dollars / SF	Terms left	Length	Approved by
LSU A&M	LSU BoS	Epsilon Zeta House Corp. of Alpha Tau Omega Fraternity	Lot 3 Fraternity Row, 15 Fraternity Lane, Baton Rouge	Fraternity House	06/18/21	06/18/21	06/30/56		\$10.00				Pres. Galligan
LSU A&M	Omega House Corporation	ServisFirst Bank	Row, 3930 W. Lakeshore Dr., Baton Rouge	renovations and additions to Fraternity House	06/18/21								Interim Pres. Galligan
LSU A&M	Pi Kappa Phi	Theta Chi	Lot 15 Sorority Row, 3940 W. Lakeshore Dr., Baton Rouge	Sublease	06/18/21		May 2024						Interim V.P Torres
LSU A&M	Sigma Chi Alumni Assn. of La. through House of Southern Woods	Constatine Housing Initiative	Lot 16 Fraternity Row, 27 Dalrymple Dr., Baton Rouge	Consent to Leasehold Mortgage	06/18/21								Pres. Galligan
HSCNO	LSU BoS	Audubon Retirement Village, Inc.	200 Henry Clay Avenue, New Orleans	Geriatric teaching-nursing facility to train physicians & allied health professionals to care for elederly & need of Louisiana	01/25/19	06/28/19	06/27/24		\$876,000.00		2	5-years	Pres. Alexander
HSCNO	HSCNO	Domingues Farm	Vermillion Parish	Agricultural Land	n/a	07/20/20	07/19/25	114 acres	\$13,075.30	n/a	1	5-years	Interim Pres. Galligan
HSCNO	HSCNO	LSU Health Foundation, New Orleans	HSCNO Campus at 1545 Tulane Ave., New Orleans	Foundation or its sublessee shall construct improvements to Butterworth & Hutchinson Bldgs.in one or more phases	05/04/18	12/22/20	12/21/25		Year 1= \$112,148 Yr 2-5 =\$220,320	\$5.75	0		Interim Pres. Galligan
HSCS	HSCS	Family Justice Center	220 Hospital Blvd., Pineville	Lease of space for use as a regional family crisis resource center	n/a	06/24/20	06/23/25	4,951	\$1,460.00		0		Interim Pres. Galligan
HSCS	Haynes Peavy, LLC	HSCS	2015 Fairfield Ave. Ste 2B, Shreveport	Partners in Wellness Clinic	n/a	01/15/21	08/16/22	3,145	\$38,675.04	\$12.30	0		Interim Pres. Galligan

Report to LSU Board of Supervisors: Property Leases

Updated October 11, 2021

All Campuses Last 3 Years

2019-2020													
Campus	Lessor or Sublessor	Lessee or Sublessee	Location	Lease Purpose	BoS Appr.	Start	Lease Term	Sq. Ft.	Annual Rental	Dollars / SF	Terms left	Length	Approved by
LSU A&M	LSU	LSU Foundation	Nicholson Gateway	Lease for Office Space in Canal Hall	n/a	05/01/19	04/30/24	1,576	\$27,300.00	\$17.32	7	5-year	Pres. Alexander
LSU A&M	La. Beta House Corporation	Congregation of Christ the King Roman Catholic Church of the Diocese of Baton Rouge	Lot 14 Fraternity Row, 23 Dalrymple Dr., Baton Rouge	1st Amendment to Sublease		09/01/19	06/30/21		\$38,400.00		3	24-mo.	Pres. Alexander
HCSO	HCSO	La. Primary Care Associates	Administrative Business Office, Airline Highway, Baton Rouge	Lease of Office Space	n/a	11/01/19	10/31/20	500	\$8,190.00	\$16.38	2	1-year	Pres. Alexander
HSCNO	HSCNO	Campus Federal Credit Union	A portion of 2nd floor of HSCNO Administration & Resource Center Building	Lease of space for banking services	n/a	07/01/19	06/30/24	786	\$25,152.00	\$32.00			Interim Pres. Galligan, Jr.

Report to LSU Board of Supervisors: Property Leases
All Campuses Last 3 Years

Updated October 11, 2021

2018-2019													
Campus	Lessor or Sublessor	Lessee or Sublessee	Location	Lease or Document Purpose	BoS Appr.	Start	Lease Term	Sq. Ft.	Annual Rental	Dollars / SF	Terms left	Length	Approved by
LSU A&M	Lambda Chi Alpha Alumni Assn. Inc.	Delta Iota House Association of Kappa Kappa Gamma Fraternity	Lot 4 Fraternity Row, 10 W. Fraternity Lane, Baton Rouge	Temporary Sublease while Sublessee constructs new House	02/01/19	07/31/20	1 yr. 6 months	7,839	see lease for terms				Exec. VP Layzell
LSU A&M	LSU	Delta Iota House Assn. of Kappa Kappa Gamma Fraternity	Lot 5 Sorority Row, 4050 W. Lakeshore Dr., Baton Rouge	Lease of Space	04/26/19	06/03/19	02/28/64		\$10.00				Pres. Alexander
LSU A&M	Delta Iota House Association of Kappa Kappa Gamma Fraternity	Cadence Bank, N.A.	Lot 5 Sorority Row, 4050 W. Lakeshore Dr., Baton Rouge	Consent to Assignment by Fraternity to Lender & Sublease for Construction of new House- multiple indebtedness mortgage	04/26/19								Exec. VP Layzell
LSU A&M	La. Beta House Corporation	Congregation of Christ the King Roman Catholic Church of the Diocese of Baton Rouge	Lot 14 Fraternity Row, 23 Dalrymple Dr., Baton Rouge	Sublease for Fraternity House		03/05/18	08/31/19		\$38,400.00		4	18-mr.	Pres. Alexander
LSU A&M	Sigma Chi Alumni Association	House of Southern Woods	Lot 16 Fraternity Road, 27 Dalrymple Drive, Baton Rouge	Assignment and Assumptin of Sigma Chi's rights and obligations by Southern Woods		11/06/18							Exec. VP Layzell
LSU A&M	LSU BoS	Louisiana State Police	LSP Training Facility	Forensic Research	n/a	09/14/18	09/13/13	.65 acres			5	1-yr.	Exec. VP Layzell
LSU A&M	LSU BoS	LSU Foundation	Canal Hall in Nicholson Gateway	For use as office space	n/a	02/01/19	01/31/24	4,576	\$27,300.00	\$17.32	7	5-yr.	Pres. Alexander
LSU A&M	LSU BoS	Tiger Athletic Foundation (TAF)	PMAC	Office & Storage Space	n/a	07/01/18	06/30/19	7,645	\$92,780.64	\$9.62	1	1-yr.	Pres. Alexander
AgCenter	Town of Vidalia	AgCenter	112 Front Street, Vidalia	Lease of Space for Concordia Parish Extension Services	n/a	06/14/18	06/13/19	1,393	\$10,000.00	\$833.33	4	1-year	Pres. Alexander
HSCNO	HSCNO	LSU School of Med in NO Faculty Group Practice	Space in the Dental School Annex	Lease of space for Ambulatory Surgery location	n/a	07/01/18	06/30/20	461	\$16,135.00	\$35.00	up to 4	1-yr.	Pres. Alexander
HSCNO	HSCNO	State of La. Dept. of Public Safety & Correction	2025 Gravier Street, New Orleans	Lease for use of office space		01/01/19	12/31/28	3,888	Lessee provides in-kind security services				Pres. Alexander
HSCNO	HSCNO	University Medical Center Management Corporation	S. Roman Street Garage	Lease for use of 207 parking spaces during construction of permanent parking	10/04/18	11/01/18	10/31/18		\$37,260.00		1 or more	1-yr.	Pres. Alexander
HSCNO	HSCNO	University of Louisiana Monroe College of Pharmacy	2025 Gravier Street	Lease of office space	05/06/16	12/01/18	11/30/23	3,437	24 mos @ \$11,1129.29, 36 mos @ \$5,012.29	24 mos @ \$38.80, 36 mos @ \$17.50	5	1-yr.	Pres. Alexander
HSCNO	HSCNO / Tulane Health Sciences Center (LCRC)	HSCNO	1710 Tulane Avenue, New Orleans	For use as office & laboratory space	12/07/18	07/01/18	06/30/30	63,233	\$2,155,050.00			10-yr.	Pres. Alexander
LSUE	LSUE	Keith Heinen	Agricultural Acreage	Agricultural Lease on LSUE land	n/a	02/01/19	01/31/22	83	\$1,660.00		2	1-yr.	Pres. Alexander

**Report to LSU Board of Supervisors:
All Campuses Last 3 Years**

Schematic Design

Updated October 11, 2021

2021-2022				
Campus	Project	Architect	Approved by	Approval Date
LSU	New Science Building	Eskew Dumez Ripple APAC	LSU Board of Supervisors	04/10/21
2020-2021				
Campus	Project	Architect	Approved by	Approval Date
LSU	Mobility Implementation- Phase I	CARBO/Reed Hilderbrand	LSU Board of Supervisors	12/04/20
AgCenter	Burden Museum & Gardens Welcome Center	EskewDumezRipple/CARBO/Suzanne Turner Associates	LSU Board of Supervisors	12/04/20
LSU HSCS	Center for Medical Education and Wellness	Coleman Partners Architects/Perkins + Will, AJV	LSU Board of Supervisors	09/16/20
2019-2020				
Campus	Project	Architect	Approved by	Approval Date
LSU	Emerge Center at Innovation Park	Coleman Partners Architects, LLC	LSU Board of Supervisors	04/26/19
HCS D	University Medical Center Management Corporation's 2nd Parking Garage	Duplantis Design Group	LSU Board of Supervisors	05/22/20
2018-2019				
Campus	Project	Architect	Approved by	Approval Date
LSU A&M	New Kappa Kappa Gamma Sorority House	Fusch Architects, Inc.	LSU Board of Supervisors	09/07/18
	Stephenson Veterinary Hospital	Tipton Associates	LSU Board of Supervisors	10/04/18
	Phi Kappa Psi Fraternity House	Coleman Partners Architects, LLC	LSU Board of Supervisors	11/02/18

**Report to LSU Board of Supervisors:
All Campuses Last 3 Years**

Servitudes

Updated October 11, 2021

2021-2022								
Campus/Lessor	Lessee	Servitude or Right-of-Way Location	Acreage	Payment	Length of Term	Type of Document	Approved by	Approval Date
AgCenter	CLECO Power LLC	Rapides Parish			In perpetuity	Line Extension Agreement	William B. Richardson	7/14/2021
2020-2021								
Campus/Lessor	Lessee	Servitude or Right-of-Way Location	Acreage	Payment	Length of Term	Type of Document	Approved by	Approval Date
AgCenter/LSUA	CLECO Power LLC	Rapides Parish			In perpetuity	Servitude Agreement	Int. Pres. Galligan	12/22/2020
AgCenter	Iris Solar, LLC	Washington Parish	839.531		As long a used by Grantee for purposes herein granted	Servitude/Right of Way Agreement	Int. Pres. Galligan	3/23/2021
LSU A&M	ExxonMobil Pipeline	East Baton Rouge Parish at Innovation Park			in perpetuity	Right-of-Way Consent Agreement	Int. Pres. Galligan	5/12/2021
2019-20200								
Campus/Lessor	Lessee	Servitude or Right-of-Way Location	Acreage	Payment	Length of Term	Type of Document	Approved by	Approval Date
AgCenter/LSU	ExxonMobil Pipeline	East Baton Rouge & Iberville Parishes		\$1,316,916.00	In perpetuity	Right of Way	Pres. Alexander	10/24/19
AgCenter	GEP Haynesville	Red River Research Station		n/a	In perpetuity	Right of Way	Int. Pres. Galligan	1/15/20
AgCenter/LSU	Entergy Louisiana, LLC	Right of Way at Burden for gas main & lateral lines at Burden		n/a	In perpetuity	Right of Way	Pres. Alexander	12/11/2019
AgCenter	Mack Energy	Ben Hur Research Station		n/a	In perpetuity	Drill Site Surface Agreement	Pres. Alexander	12/19/2019
2018-2019								
Campus/Lessor	Lessee	Servitude or Right-of-Way Location	Acreage	Payment	Length of Term	Type of Document	Approved by	Approval Date
AgCenter	Corps of Engineers	Right-of-entry for Flood Control		\$0.00	2 years	Statutory Notification of the Grant	5th La. Levee District & 5th La. Levee Bd.	10/1/18
LSU A&M	Entergy	S54-T7S-R1W East Bat Rouge Parish (Nicholson Gateway area)	unspecified		Permanent	Right-of-Way	Pres. Alexander	6/27/2018

Report to LSU Board of Supervisors: Timber Sales
All Campuses Last 3 Years

Updated October 11, 2021

2021-2022								
Campus	Location	Parish	Buyer	Acreage	Payment	Designated Timber to be Removed:	Approved by	Approval Date
2020-2021								
Campus	Location	Parish	Buyer	Acreage	Payment	Designated Timber to be Removed:	Approved by	Approval Date
AgCenter	Lee Memorial Forest	Washington	Timber Sale Contract	168	\$49,268.50	Pine saw timber, pine pulpwood, hardwood saw timber, and hardwood pupl components	Interim Pres. Galligan	12/15/2020
AgCenter	Bob R. Jones Widlwild Research Station	E. Feliciana	Request for Timber Sale only	91	Approximately \$145,000	Pine saw timber, pine pulpwood, hardwood saw timber, and hardwood pupl components	AVP Martin	3/1/2021
2019-2020								
Campus	Location	Parish	Buyer	Acreage	Payment	Designated Timber to be Removed:	Approved by	Approval Date
AgCenter	Jones Idlewild Research Station	E. Feliciana	Request for Timber Sale only	45	approximately \$120,000	Pine logs, red oak logs, misc. logs & hardwood pulp.	AVP Martin	8/30/2019
AgCenter	Hill Farm Research Station	Lafayette	Request for Timber Sale only	27.3	approximately \$78,000	Pine saw timber and pine pulpwood	AVP Martin	8/1/2019
2018-2019								
Campus	Location	Parish	Buyer	Acreage	Payment	Designated Timber to be Removed:	Approved by	Approval Date
AgCenter	Jones Idlewild Research Station	E. Feliciana	Good Hope, Inc.		\$ 138,950	17-acre clear cut, 14-acre clear cut and 22-acre site. All pine sawtimber along with hardwaood sawtimer, chip & saw, and pulpwood will be removed.	Pres. Alexander	11/6/2018

**Report to LSU Board of Supervisors:
All Campuses Last 3 Years**

Transfers of Title to Immovable Property

Updated October 11, 2021

2021-2022						
Campus	Transfer Description	Value	State ID	Site Code	Approved by	Transfer Date
2020-2021						
Campus	Transfer Description	Value	State ID	Site Code	Approved by	Transfer Date
HSCNO	Purchase of Property at 508-510 S. Galvez St., New Orleans	\$240,000	n/a	n/a	Interim Pres. Galligan	08/28/20
LSU A&M	Act of Donation by Tiger Athletic Foundation of Athletic Team Room	\$397,736			Int. Pres. Galligan	03/08/21
LSU A&M	Act of Donation by Tiger Athletic Foundation of Cox Academic Center Computer Lab	\$820,002			Int. Pres. Galligan	03/08/21
LSU A&M	Act of Donation by Tiger Athletic Foundation of Football Operations Air Handler Upgrades	\$479,094			Int. Pres. Galligan	03/08/21
LSU A&M	Act of Donation by Tiger Athletic Foundation of Gymnastic Practice Facility Vault Life Installation	\$142,871			Int. Pres. Galligan	03/08/21
LSU A&M	Act of Donation by Tiger Athletic Foundation of PMAC Floor Expansion and Refinishing	\$159,662			Int. Pres. Galligan	03/08/21
LSU A&M	Act of Donation by Tiger Athletic Foundation of Pete Maravich Assembly Center Indoor Lighting Replacement	\$83,873			Int. Pres. Galligan	03/08/21
LSU A&M	Act of Donation by Tiger Athletic Foundation of Tiger Stadium East and West Bowl Structural Repairs	\$484,496			Int. Pres. Galligan	03/08/21
LSU A&M	Act of Donation by Tiger Athletic Foundation of Tiger Stadium Room Updatesawton	\$421,587			Int. Pres. Galligan	03/08/21
LSU A&M	Act of Donation by Tiger Athletic Foundation of Tiger Stadium North Players Chute Improvements	\$151,620			Int. Pres. Galligan	03/08/21
LSU A&M	Act of Donation by Tiger Athletic Foundation of Tiger Stadium West Plaza National championship Monument Upgrades	\$88,034			Int. Pres. Galligan	03/08/21
LSU A&M	Act of Donation by SLA, LLC of Julian T. White Mural to the atrium of the design building in the College of Art & Design	\$56,000			Int. Pres. Galligan	05/27/20
2019-2020						
Campus	Transfer Description	Value	State ID	Site Code	Approved by	Transfer Date
LSU A&M	Act of Donation by Burden Foundation to LSU Rural Life of 1 acre	\$525,000			Pres. Alexander	12/19/19
LSU A&M	Act of Donation by Laurel Hill LLC of West Feliciana Property	\$335,000			Int. Pres. Galligan	05/22/20
LSU A&M	Act of Donation by TAF of Alex Box Champions Plaza	\$874,014			Int. Pres. Galligan	01/22/20
LSU A&M	Act of Donation by TAF of Alex Box Practice Facility Pitching Center	\$163,788			Int. Pres. Galligan	01/22/20
LSU A&M	Act of Donation by TAF of Football Operations Renovations and Expansion Phase II	\$31,750,344			Int. Pres. Galligan	01/22/20
LSU A&M	Act of Donation by TAF of Golf Practice Facility Hitting Bay Improvements	\$39,538			Int. Pres. Galligan	01/22/20
LSU A&M	Act of Donation by TAF of Tennis Complex Resurfacing of Courts	\$178,187			Int. Pres. Galligan	01/22/20
LSU A&M	Act of Donation by TAF of Tiger Stadium East Bowl Improvements	\$1,770,741			Pres. Alexander	08/28/19
LSU A&M	Act of Donation by TAF of Tiger Stadium North Bowl Improvements	\$1,393,251			Pres. Alexander	08/28/19
LSU A&M	Act of Donation by TAF of Tiger Stadium North End Zone Joint Repairs	\$350,000			Pres. Alexander	08/28/19
LSU A&M	Act of Donation by TAF of Tiger Stadium Restroom Renovation Phase II	\$2,354,042			Pres. Alexander	08/28/19
LSU A&M	Act of Donation by TAF of Tiger Stadium South Plaza Bowl Recognition	\$927,034			Int. Pres. Galligan	01/22/20
LSU A&M	Act of Donation by TAF of Tiger Stadium West Bowl Improvements	\$1,798,191			Pres. Alexander	08/28/19
LSU A&M	Purchase from Denovo Properties LLC the west 1/2 of lot 56, and all of lots 58 & 60, West Roosevelt Street in Square 100 S. Baton Rouge Subdivision	\$25,000			Pres. Alexander	08/09/19
HSCNO	Act of Donation by the Louisiana State University School of Medicine in New Orleans Faculty Group Practice (Network) of the construction completed jointly of an entrance canopy at the UMOB. jointly completed with HSCNO at the UMOB. Each paid 50% of cost of improvements. This donation is the donation of all of Network's interest, right and title in the improvements	approximately \$130,234			Pres. Alexander	10/24/19
LSUS	Act of Donation by the National Society of the Colonial Dames of America in the State of Louisiana to LSUS Realty, LLC (sole member of the LSU in Shreveport Foundation) of the Spring Street Museum in Shreveport ¹	see footnote			Pres. Alexander	10/04/19
HSCNO	CEA transferring Hainkel Home in New Orleans, property including land, physical plant and equipment to LSU	n/a			Pres. Alexander	10/29/19
	¹ Building appraised at \$145,000, contents valued at \$100,000, sole beneficiary of the Helen Mann Memorial Fund Committee, Inc. valued as of 3/31/19 \$1,104,794					

**Report to LSU Board of Supervisors:
All Campuses Last 3 Years**

Transfers of Title to Immovable Property

Updated October 11, 2021

2018-2019						
Campus	Transfer Description	Value	State ID	Site Code	Approved by	Transfer Date
LSU A&M	Act of Donation by Recital Hall LLC (REFF) of Virginia Martin Howard Board Room	\$116,918			Pres. Alexander	06/27/19
LSU A&M	Act of Donation by SLA, LLC (REFF) of the Renovations & Improvements to office areas & commons space School of Landscape Architect	\$529,199			Pres. Alexander	06/27/19
LSU A&M	Act of Donation by TAF of Alex Box Batting Cage Renovations & Additions	\$3,722,871			Pres. Alexander	06/27/19
LSU A&M	Act of Donation by TAF of Beech Volleyball Waterproofing Repairs	\$198,663			Pres. Alexander	06/27/19
LSU A&M	Act of Donation by TAF of Bernie Moore Track Resurfacing	\$1,303,713			Pres. Alexander	06/27/19
LSU A&M	Act of Donation by TAF of Martin J. Broussard Hydrotherapy Pool Replacement and Renovation Project	\$916,777			Pres. Alexander	06/27/19
LSU A&M	Act of Donation by TAF of Tiger Stadium Concessions and Replacement Improvements	\$646,462			Pres. Alexander	06/27/19
LSU A&M	Act of Donation by the LSU Foundation of a life-sized Bengal tiger sculpture outside the Admissions & Recruiting Center at Pleasant Hall	\$106,627			Pres. Alexander	05/14/19
LSU A&M	Act of Donation by the LSU Property Foundation and Acceptance by LSU of design development services for restoration & renovation to the LSU Memorial Tower and adjacent plazas	\$568,725			Pres. Alexander	10/12/18
LSU A&M	Act of Donation for the Improvements constructed to the existing office space of the University Lab School's administration offices	\$123,218			Pres. Alexander	10/02/18
LSU A&M	Act of Donation of Dr. Billy Cannon Statue Installation and Plaza	\$268,296			Pres. Alexander	12/04/18
LSU A&M	Act of Donation of Natatorium Lighting by Tiger Athletic Foundation to LSU	\$312,444			Pres. Alexander	12/17/18
LSU A&M	Property Exchange between LSU & Louisiana National Guard	Equivalent value			Pres. Alexander	11/20/18
LSU A&M	Purchase of 604 West Roosevelt Property	\$155,708			Pres. Alexander	09/11/18
AgCenter	Act of Donation by LSU Property Foundation to AgCenter of Grant Parish Property	\$63,300			Pres. Alexander	12/12/18
HSCNO	Act of Donation by LSU Health Foundation and Acceptance of Property at 526 S. Roman St., New Orleans	\$187,000			Pres. Alexander	02/01/18
HSCNO	Act of Donation by Mariner's Village Properties LLC & Mariner's Village Marina, LLC				Pres. Alexander	12/20/18
HSCNO	Purchase of 4 Properties on South Galvez, 424-426, 428-430, 432-434, and 436-438	\$1,054,962			Pres. Alexander	12/17/18
HSCNO	Purchase of property at 508-510 S. Galvez St., New Orleans from Michael J. Clark	\$240,000			Pres. Alexander	03/11/19
LSUE	Transfer Student Housing from the Eunice Student Housing Founding, Inc. to the LSU Real Estate and Facilities Foundation	\$6,597,555			Pres. Alexander	02/08/19

**LSU First Board Report
Pharmacy Expense Year To Date
2020 vs. 2021**

	January	February	March	April	May	June	July	August	September	Total
Claims- Citizens RX-2020	2,983,154	2,576,554	2,873,478	2,642,483	2,572,698	2,580,858	2,551,188	2,538,641	2,775,535	\$24,094,590
Rebates- Citizens RX-2020			-249,425			-195,326			-239,396	-\$684,146
Total Citizens RX-2020										\$23,410,443
Claims-MedImpact Pharmacy 2021	1,774,286	2,157,283	2,633,863	2,299,304	2,394,931	2,426,055	2,969,379	2,469,781	2,761,678	\$21,886,562
Rebates-MedImpact Pharmacy 2021			-1,058,783						-1,693,669	-\$2,752,452
Total MedImpact Pharmacy 2021										\$19,134,110
Difference/Savings 2020 vs. 2021										\$4,276,334

Adjudicated Year Month	Rx Count	Brand Count	Brand %	Generic Count	Generic %
2021-01	23,582	2,130	9.0%	21,452	91.0%
2021-02	22,850	2,193	9.6%	20,657	90.4%
2021-03	28,360	3,793	13.4%	24,567	86.6%
2021-04	26,724	3,249	12.2%	23,475	87.8%
2021-05	26,431	2,569	9.7%	23,862	90.3%
2021-06	27,353	2,603	9.5%	24,750	90.5%
2021-07	27,018	2,573	9.5%	24,445	90.5%
2021-08	25,788	2,795	10.8%	22,993	89.2%
2021-09	26,442	2,969	11.2%	23,473	88.8%
Summary	234,548	24,874	10.6%	209,674	89.4%

**LSU First Board Report
Pharmacy Expense Year To Date
2019-2021**

	January	February	March	April	May	June	July	August	September	Total
Claims- Citizens RX-2020	2,983,154	2,576,554	2,873,478	2,642,483	2,572,698	2,580,858	2,551,188	2,538,641	2,775,535	\$24,094,590
Rebates- Citizens RX-2020			-249,425			-195,326			-239,396	-\$684,146
Total Citizens RX-2020										\$23,410,443
Claims-MedImpact Pharmacy 2021	1,774,286	2,157,283	2,633,863	2,299,304	2,394,931	2,426,055	2,969,379	2,469,781	2,761,679	\$21,886,563
Rebates-MedImpact Pharmacy 2021			-1,058,783						-1,693,669	-\$2,752,452
Total MedImpact Pharmacy 2021										\$19,134,111
Difference/Savings 2020 vs 2021										\$4,276,333
Claims- Citizens RX-2019	2,592,754	2,485,974	2,330,203	2,573,666	2,511,422	2,393,556	2,610,911	2,575,435	2,648,319	\$22,722,241
Rebates- Citizens RX-2019			-245,069			-231,392			-261,042	-\$737,503
Total Citizens RX-2019										\$21,984,738